

SURFACE MOUNT HIGH REPEATABILITY, BROADBAND TO-5 RELAYS DPDT

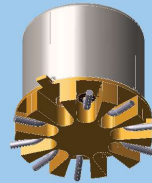

| SERIES | RELAY TYPE |
|---------|---------------------------------|
| SGRF300 | Repeatable, RF relay |
| SGRF303 | Sensitive, repeatable, RF relay |

DESCRIPTION

The ultraminiature SGRF300 and SGRF303 relays are designed to provide a practical surface-mount solution with improved RF signal repeatability over the frequency range. SGRF300 and SGRF303 relays feature a unique ground shield that isolates and shields each lead to ensure excellent contact-to-contact and pole-to-pole isolation. This ground shield provides a ground interface that results in improved highfrequency performance as well as parametric repeatability. The SGRF300 and SGRF303 extend performance advantages over similar RF devices that simply offer formed leads for surface mounting. These relays are engineered for use in RF attenuator, RF switch matrices, ATE and other applications that require dependable high frequency signal fidelity and performance.

The SGRF300 and SGRF303 feature:

- High repeatability
- Broader bandwidth
- Metal enclosure for EMI shielding
- High isolation between control and signal paths
- High resistance to ESD

The following unique construction features and manufacturing techniques provide excellent robustness to environmental extremes and overall high reliability:

- Uniframe motor design provides high magnetic efficiency and mechanical rigidity
- Minimum mass components and welded construction provide maximum resistance to shock and vibration
- Advanced cleaning techniques provide maximum assurance of internal cleanliness
- Gold-plated precious metal alloy contacts ensure reliable switching
- Hermetically sealed

| ENVIRONMENTAL AND PHYSICAL SPECIFICATIONS | | |
|---|------------------|--------------------------|
| Temperature (Ambient) | Storage | -65°C to +125°C |
| | Operating | -55°C to +85°C |
| Vibration (General Note I) | | 10 g's to 500 Hz |
| Shock (General Note I) | | 30 g's, 6ms half sine |
| Enclosure | | Hermetically sealed |
| Weight | SGRF300 | 0.09 oz. (2.55g) max. |
| | SGRF303 | 0.16 oz. (4.5g) max. |

INTERNAL CONSTRUCTION

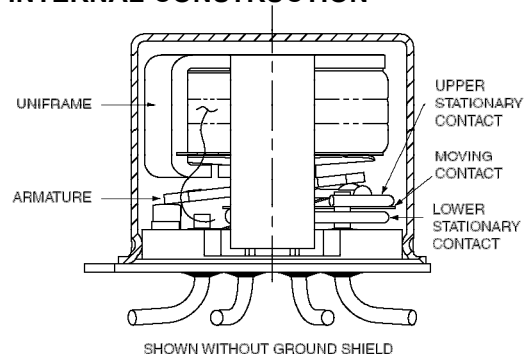

SERIES SGRF300/SGRF303
TYPICAL RF CHARACTERISTICS (See RF Notes)

Isolation Across Contacts (RF Note 4)

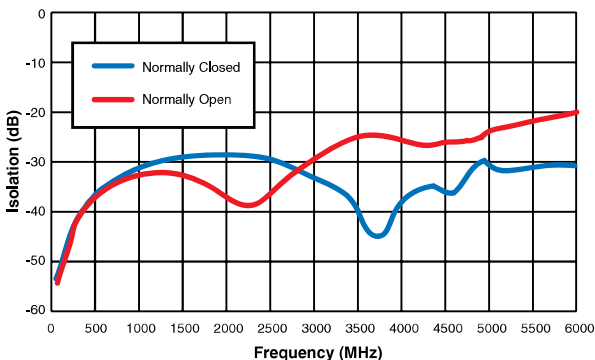

Isolation Pole to Pole (RF Note 5)

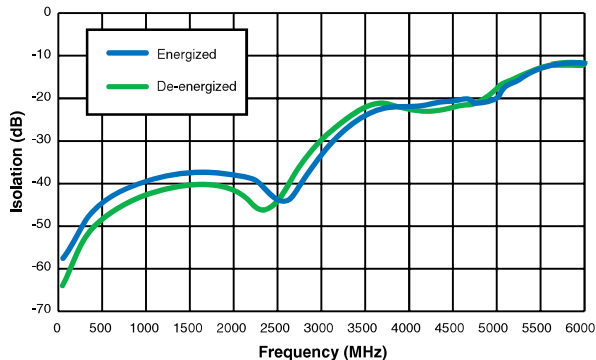

Insertion Loss (RF Note 6)

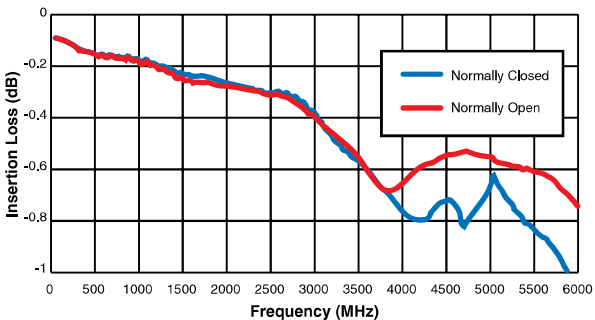

VSWR (RF Note 6)

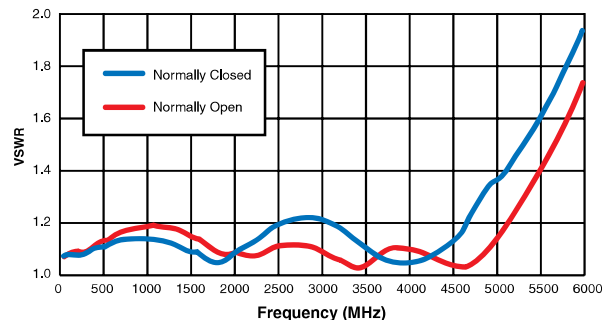

SGRF300 Time Response (RF Note 6)

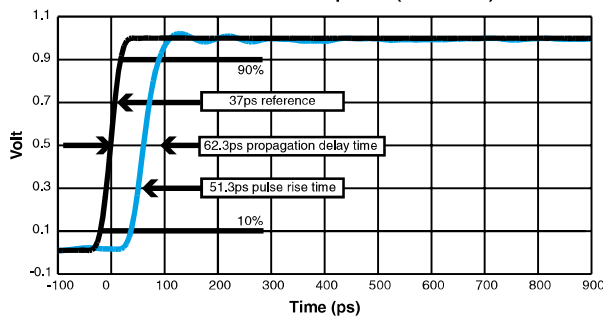

RF NOTES

- Test conditions:
 - Fixture: .031" copper clad, reinforced PTFE, RT/duroid® 6002 with SMA connectors. (RT/duroid® is a registered trademark of Rogers Corporation.)
 - RF ground shield is soldered to PCB RF ground plane.
 - Room ambient temperature.
 - Terminals not tested were terminated with 50-ohm load.
 - Contact signal level: -10 dBm.
 - No. of test samples: 2.
- Data presented herein represents typical characteristics and is not intended for use as specification limits.
- Data is per pole, except for pole-to-pole data.
- Data is the average from readings taken on all open contacts.
- Data is the average from readings taken on poles with coil energized and de-energized.
- Data is the average from readings taken on all closed contacts.
- Test fixture effect de-embedded from frequency and time response data.

SERIES SGRF300 AND SGRF303
TYPICAL RF INSERTION LOSS REPEATABILITY CHARACTERISTICS
(See RF Insertion Loss Repeatability Notes)

REPEATABILITY CHARACTERISTICS SGRF300 RELAYS

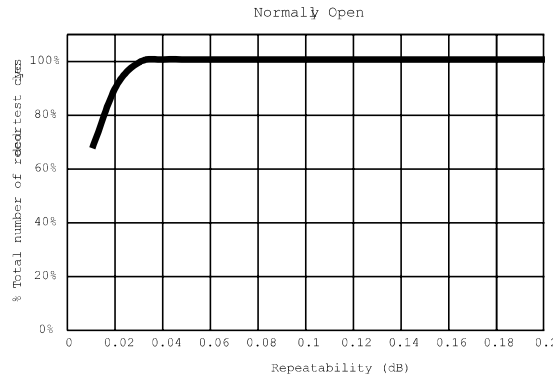
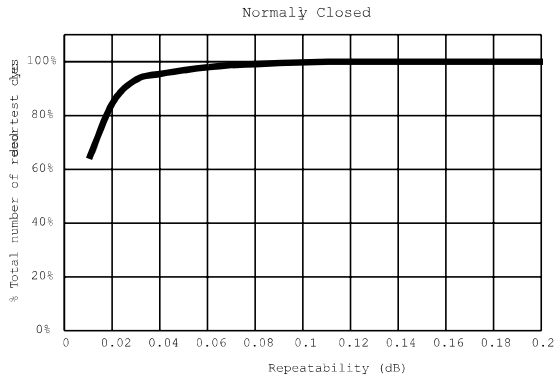

REPEATABILITY CHARACTERISTICS SGRF303 RELAYS

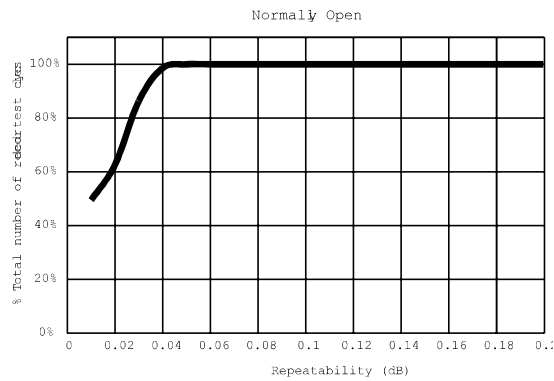
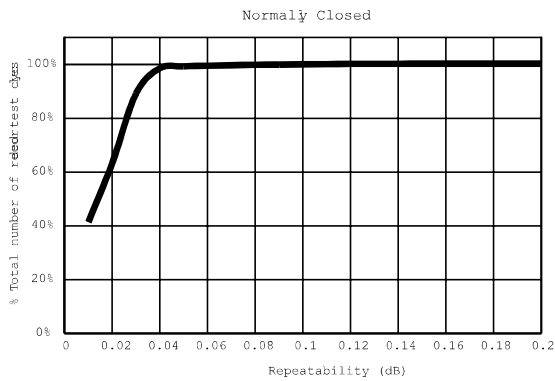

RF INSERTION LOSS REPEATABILITY NOTES

- Test conditions:
 - Fixture: .031" copper clad, reinforced PTFE, RT/duroid® 6002 with SMA connectors. (RT/duroid® is a registered trademark of Rogers Corporation.)
 - Test performed at room ambient temperature.
 - Contact signal level: 20dBm.
- Data presented herein represents typical characteristics and is not intended for use as specification limits.
- Insertion loss repeatability measured over frequency range from 50MHz to 4GHz.

SERIES SGRF300/SGRF303

TYPICAL RF REPEATABILITY PERFORMANCE (See RF Notes 1,2 and 3)

1 Million Cycle Repeatability ±0.1 dB from DC to 3GHz

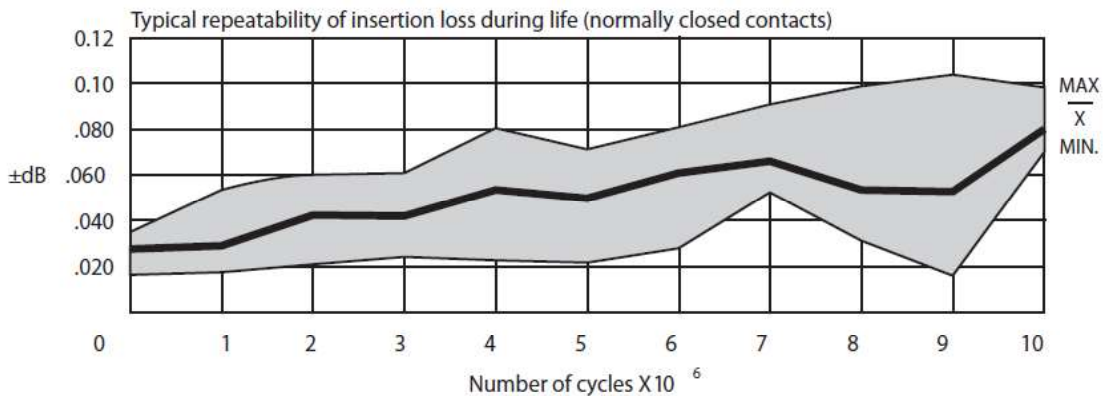
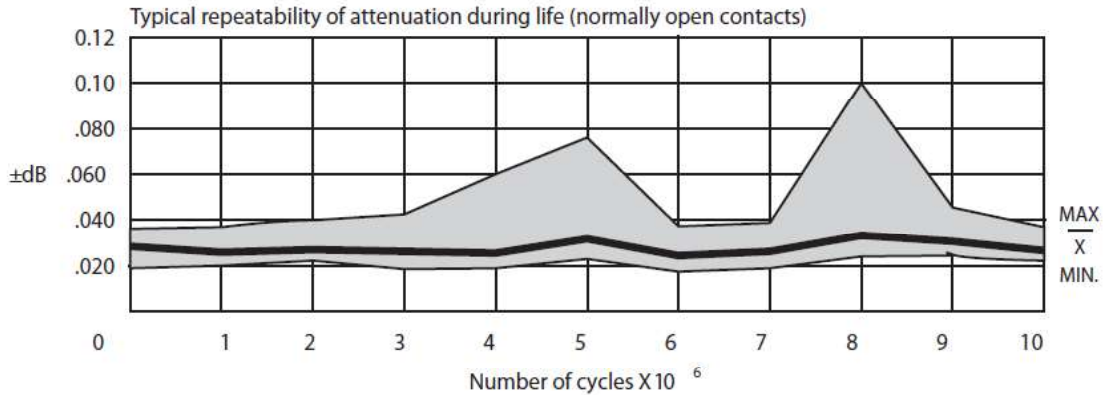

RF NOTES

1. One million cycle repeatability data is based upon 396 observations with an average repeatability ±0.033 dB and a range of ±0.093 dB.
2. Repeatability of attenuation values were obtained from tests conducted in a 20 dB attenuator network with a 0 dBm input signal.
3. Relay operates at frequencies higher than 3 GHz with reduced RF performance characteristics.
4. Curves were developed from tests performed on a 0.031" copper clad, reinforced PTFE circuit board at 20°C (ref). The unused contacts were terminated in 50 ohms; characteristic impedance of measuring equipment is 50 ohms. The relays were mounted flush to the circuit board ground plane without the relay header soldered to the ground plane.

SERIES SGRF300/SGRF303
GENERAL ELECTRICAL SPECIFICATIONS (@25°C)

| | | |
|---------------------------------|---|-----------------------------------|
| Contact Arrangement | 2 Form C (DPDT) | |
| Rated Duty | Continuous | |
| Contact Resistance | 0.15 Ω max. | |
| Contact Load Rating | Resistive: 1Amp/28Vdc Low level: 10 to 50 μA @ 10 to 50 mV | |
| Contact Life Ratings | 10,000,000 cycles (typical) at low level | |
| Coil Operating Power | SGRF300-5: 500 mW @ nominal coil | SGRF300-12: 370 mW @ nominal coil |
| | SGRF303-5: 250 mW @ nominal coil | SGRF303-12: 169 mW @ nominal coil |
| Operate Time | SGRF300: 4.0 mS max. SGRF303: 6.0 mS max. | |
| Release Time | SGRF300: 3.0 mS max. | |
| | SGRF303: 3.0 mS max. | |
| Intercontact Capacitance | 0.4 pf typical | |
| Insulation Resistance | 1,000 MΩ min. between mutually isolated terminals | |
| Dielectric Strength | 350 Vrms (60 Hz) @ atmospheric pressure | |

DETAILED ELECTRICAL SPECIFICATIONS (@25°C)

| BASE PART NUMBERS (SGRF300) | | SGRF300-5 | SGRF300-12 |
|------------------------------------|---------|-----------|------------|
| Coil Voltage, Nominal (Vdc) | | 5.0 | 12.0 |
| Coil Resistance (Ohms ±20%) | SGRF300 | 50 | 390 |
| Pick-up Voltage (Vdc max.) | SGRF300 | 3.6 | 9.0 |

| BASE PART NUMBERS (SGRF303) | | SGRF303-5 | SGRF303-12 |
|------------------------------------|---------|-----------|------------|
| Coil Voltage, Nominal (Vdc) | | 5.0 | 12.0 |
| Coil Resistance (Ohms ±20%) | SGRF303 | 100 | 850 |
| Pick-up Voltage (Vdc max.) | SGRF303 | 3.6 | 9.0 |

SERIES SGRF300/SGRF303
TYPICAL SIGNAL INTEGRITY CHARACTERISTICS @ 10 Gbps

Normally Closed (Typ.)

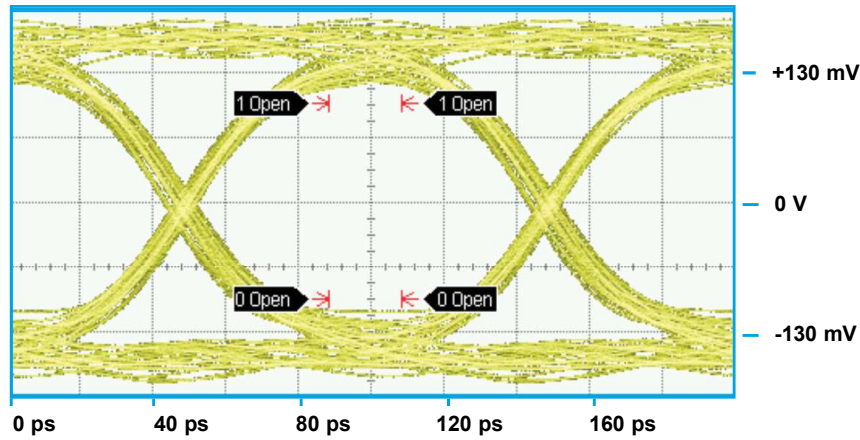

| Bit Rate | Eye Height | Eye Width | Jitter _{P-P} |
|----------|------------|-----------|-----------------------|
| 10 Gbps | 195.3 mV | 87.41 ps | 9.78 ps |

Normally Open (Typ.)

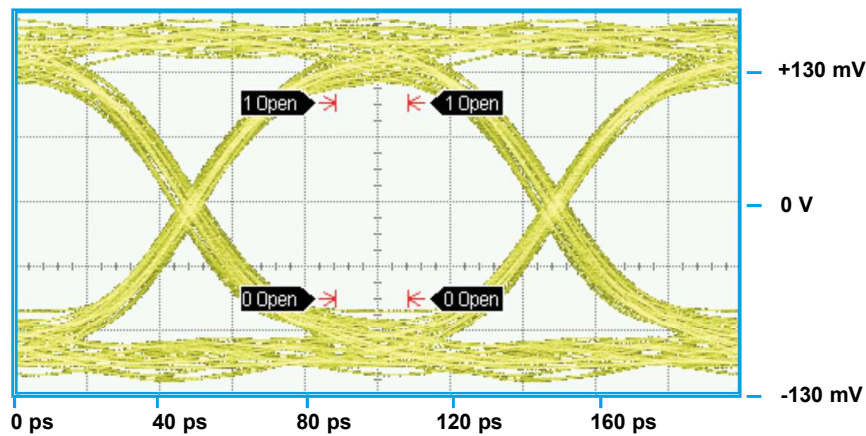

| Bit Rate | Eye Height | Eye Width | Jitter _{P-P} |
|----------|------------|-----------|-----------------------|
| 10 Gbps | 197.4 | 82.95 ps | 10.67 ps |

PATTERN GENERATOR SETTINGS

- 10 Gbps Random Pulse Pattern Generator
- 2³¹ - 1 PRBS signal
- PRBS output of 300 mV_{P-P} (nominal)
- RF PCB effect (negligible) not removed from measurement
- Data shown is typical of both poles

SERIES SGRF300/SGRF303
TYPICAL SIGNAL INTEGRITY CHARACTERISTICS @ 18 Gbps

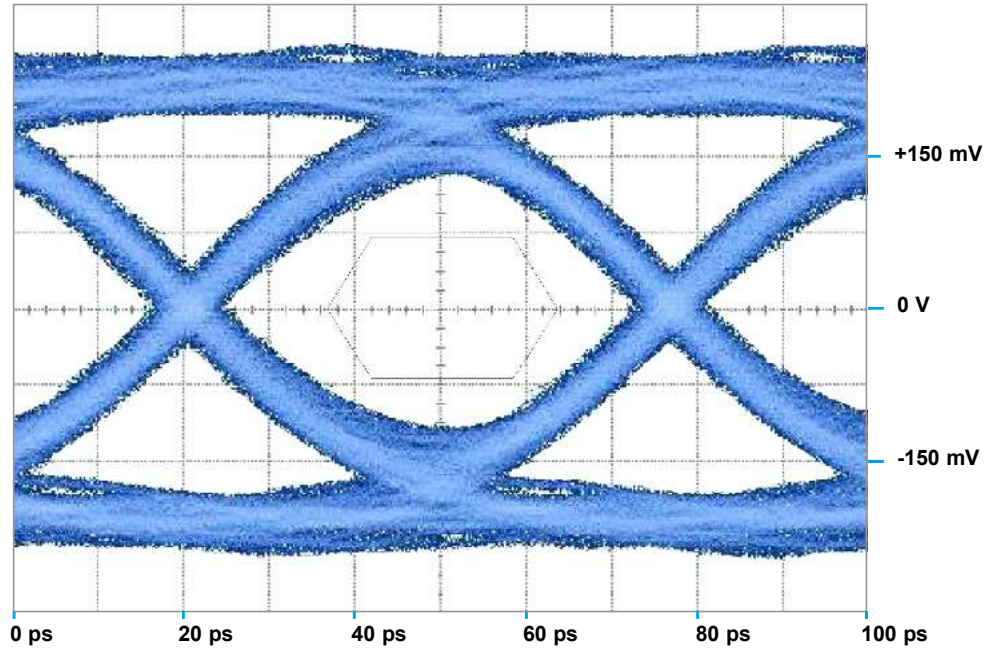

| Bit Rate | Eye Height | Eye Width | Jitter _{P-P} |
|----------|------------|-----------|-----------------------|
| 18 Gbps | 185 mV | 46.4 ps | 10.44 ps |

PATTERN GENERATOR SETTINGS

- 18 Gbps Random Pulse Pattern Generator
- $2^{31} - 1$ PRBS signal
- PRBS output of 300 mV_{P-P} (nominal)
- RF PCB effect (negligible) not removed from measurement
- Data shown is typical of both poles

Данный компонент на территории Российской Федерации

Вы можете приобрести в компании MosChip.

Для оперативного оформления запроса Вам необходимо перейти по данной ссылке:

<http://moschip.ru/get-element>

Вы можете разместить у нас заказ для любого Вашего проекта, будь то серийное производство или разработка единичного прибора.

В нашем ассортименте представлены ведущие мировые производители активных и пассивных электронных компонентов.

Нашей специализацией является поставка электронной компонентной базы двойного назначения, продукции таких производителей как XILINX, Intel (ex.ALTERA), Vicor, Microchip, Texas Instruments, Analog Devices, Mini-Circuits, Amphenol, Glenair.

Сотрудничество с глобальными дистрибьюторами электронных компонентов, предоставляет возможность заказывать и получать с международных складов практически любой перечень компонентов в оптимальные для Вас сроки.

На всех этапах разработки и производства наши партнеры могут получить квалифицированную поддержку опытных инженеров.

Система менеджмента качества компании отвечает требованиям в соответствии с ГОСТ Р ИСО 9001, ГОСТ РВ 0015-002 и ЭС РД 009

Офис по работе с юридическими лицами:

105318, г.Москва, ул.Щербаковская д.3, офис 1107, 1118, ДЦ «Щербаковский»

Телефон: +7 495 668-12-70 (многоканальный)

Факс: +7 495 668-12-70 (доб.304)

E-mail: info@moschip.ru

Skype отдела продаж:

moschip.ru

moschip.ru_4

moschip.ru_6

moschip.ru_9