

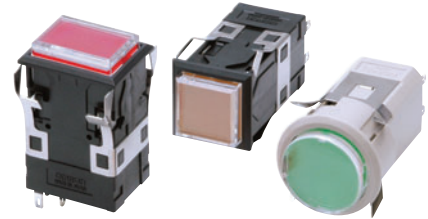

Large Rectangular-bodied Indicators

- Excellent illumination with even surface brightness.
- Three-color models (green, orange, red; chameleon lighting) included in lineup.



 Refer to *Safety Precautions for All Pushbutton Switches and Safety Precautions of A3P.*

List of Models

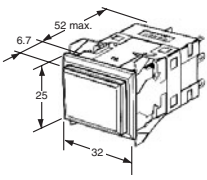
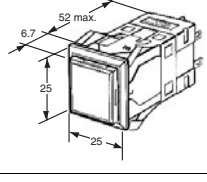
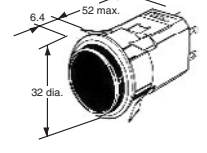
Model	Appearance
M2PJ (Rectangular)	
M2PA (Square)	
M2PT (Round)	

■ Panel cutout dimensions: Refer to page 12. ■ Dimensions: Refer to page 11.
 ■ Accessories, replacements, and tools: Refer to the A3P. ■ Specifications: Refer to the A3P.

Model Number Structure

Model Number Legend The model numbers used to order sets of Units are illustrated below. One set comprises the Display, Lamp, and Socket.

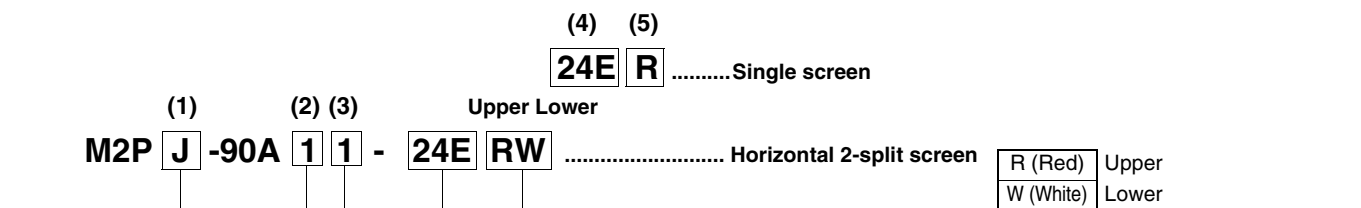

For information on combinations, refer to *Ordering Information*.



(1) Shape of Display

Symbol	Shape
J	Rectangular
A	Square
T	Round

(2) Screen Pattern

Illumination-only models	
Symbol	Screen pattern
1	Single screen 
2	2-split screen 
G	Chameleon *1  Note: The chameleon screen pattern is not available with M2PT models. The chameleon screen pattern is only available with 12 or 24-VDC models.

*1. With chameleon models, the whole screen lights red, green, or orange. When not lit, the display is white.

• The available rectangular models are shown below. Select from among the individual products shown on page 7.

Vertical 2-split screen models 4-split screen models



Horizontal 3-split screen models Vertical 3-split screen models

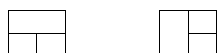

The above diagrams show the Sockets with the "OMRON" mark facing down.

▶ Colored-illumination models up to the 4-split screen models are available as individual Units. Refer to page 7.

▶ "Colored-illumination" models operate in the way shown below:

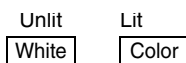

The built-in LED is colored.

(3) Case Color

Symbol	Color
1	Black
2	Light gray

Note: M2PT model is available in light gray only.

(4) Lighting Method LED-lighted Models (M2PJ and M2PA Only)

Symbol	Rated voltage
05E	5 VDC
12E	12 VDC
24E	24 VDC

LED Lamp-lighted Models (M2PT Only)

Symbol	Rated voltage
05C	5 VDC
12C	12 VDC
24C	24 VDC

Note: M2PJ and M2PA can also be ordered separately. Refer to page 7 for details.

Incandescent Lamp lighted Models

Symbol	Rated voltage
06	6 VAC/VDC
14	14 VAC/VDC
28	28 VAC/VDC

(5) Color of Display For LED

Symbol	Color
R	Red
O	Orange
G	Green
W	White
K	Chameleon

- The chameleon screen pattern is not available with M2PT models.
- The chameleon screen pattern is only available with 12 or 24-VDC models.

For Incandescent Lamp

Symbol	Color
No symbol	Red, Orange, White, Blue, Green

- Includes colored plate. Refer to page 8 for details.
- (Low-power incandescent lamp)

Number of Built-in LED Lamps

Screen pattern	A3PJ	A3PA	A3PT
Single screen	Built-in LED models		2
Horizontal 2-split screen			---
Vertical 2-split screen			
Horizontal 3-split screen	4 *2	---	---
Vertical 3-split screen			
4-split screen			

Number of Built-in Incandescent Lamps

Screen pattern	A3PJ	A3PA	A3PT
Single screen	2	1	2
Horizontal 2-split screen	4 (Low-power incandescent lamp) *2	2	---
Vertical 2-split screen		---	---
3-split, E shape/T shape		---	---
4-split screen		---	---

*2. These split screen models are available only as individual Units. They cannot be ordered as sets.

Ordering Information

Ordering as a Set The model numbers used to order sets of Units are given in the following tables. One set comprises the Display, Lamp, and Socket.

M2PJ (Rectangular) Single Screen Models

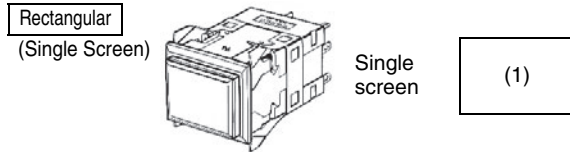

Case color		Black	Light gray	Display color symbol
LED	5 VDC	M2PJ-90A11-05E(1)	M2PJ-90A12-05E(1)	R O G W
	12 VDC	M2PJ-90A11-12E(1)	M2PJ-90A12-12E(1)	
	24 VDC	M2PJ-90A11-24E(1)	M2PJ-90A12-24E(1)	
Chameleon	12 VDC	M2PJ-90AG1-12EK	M2PJ-90AG2-12EK	*1
	24 VDC	M2PJ-90AG1-24EK	M2PJ-90AG2-24EK	
Incandescent lamp	6 VDC/VAC	M2PJ-90A11-06	M2PJ-90A12-06	*2
	14 VDC/VAC	M2PJ-90A11-14	M2PJ-90A12-14	
	28 VDC/VAC	M2PJ-90A11-28	M2PJ-90A12-28	

Note: Enter the desired color symbol for the Display in (1). (R) = Red, (O) = Orange, (G) = Green, (W) = White.

Example: Red M2PJ-90A11-24ER

*1. You can change the screen colors of chameleon models between red, green, and orange by changing the terminal wiring. Refer to page 14 for details.

*2. Incandescent lamps are supplied with colored plates (white, red, green, blue, and orange) and legend plates (milk-white and transparent). Use the appropriate combination.

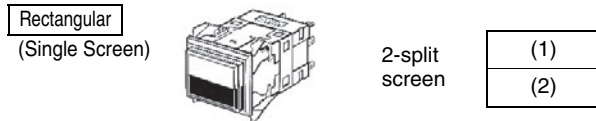

Case color		Black	Light gray	Display color symbol
LED	24 VDC	M2PJ-90A21-24E(1)(2)	M2PJ-90A22-24E(1)(2)	R O G W
Incandescent lamp	6 VDC/VAC	M2PJ-90A21-06	---	*
	14 VDC/VAC	M2PJ-90A21-14	M2PJ-90A22-14	
	28 VDC/VAC	M2PJ-90A21-28	M2PJ-90A22-28	

Note: Enter the desired color symbols for the Display in (1) and (2). (R) = Red, (O) = Orange, (G) = Green, (W) = White.

Example: Red Upper M2PJ-90A21-24ERW
White Lower R W
Red White

* Incandescent lamps are supplied with colored plates (white, red, green, blue, and orange) and legend plates (milk-white and transparent). Use the appropriate combination.

Individual models: Refer to pages 6 to 8.
(The Display, Lamp, and Socket can be ordered separately.)

■ Specifications: Refer to the A3P.
■ Dimensions: Refer to page 11. Accessories: Refer to the A3P.

Ordering Information

Ordering as a Set.....The model numbers used to order sets of Units are given in the following tables. One set comprises the Display, Lamp, and Socket.

M2PA (Square) Single Screen Models



Case color		Black	Light gray	Display color symbol
LED	5 VDC	M2PA-90A11-05E(1)	M2PA-90A12-05E(1)	ROGW
	12 VDC	M2PA-90A11-12E(1)	M2PA-90A12-12E(1)	
	24 VDC	M2PA-90A11-24E(1)	M2PA-90A12-24E(1)	
Chameleon	12 VDC	M2PA-90AG1-12EK	M2PA-90AG2-12EK	*1
	24 VDC	M2PA-90AG1-24EK	M2PA-90AG2-24EK	
Incandescent lamp	6 VDC/VAC	M2PA-90A11-06	M2PA-90A12-06	*2
	14 VDC/VAC	M2PA-90A11-14	M2PA-90A12-14	
	28 VDC/VAC	M2PA-90A11-28	M2PA-90A12-28	

Note: Enter the desired color symbol for the Display in (1). (R) = Red, (O) = Orange, (G) = Green, (W) = White.

Example: Red M2PA-90A11-24ER

*1. You can change the screen colors of chameleon models between red, green, and orange, by changing the terminal wiring. Refer to page 14 for details.

*2. Incandescent lamps are supplied with colored plates (white, red, green, blue, and orange) and legend plates (milk-white and transparent). Use the appropriate combination.



Case color		Black	Light gray	Display color symbol
LED	24 VDC	M2PA-90A21-24E(1)(2)	M2PA-90A22-24E(1)(2)	ROGW
Incandescent lamp	6 VDC/VAC	M2PA-90A21-06	M2PA-90A22-06	*
	14 VDC/VAC	M2PA-90A21-14	M2PA-90A22-14	
	28 VDC/VAC	M2PA-90A21-28	M2PA-90A22-28	

Note: Enter the desired color symbols for the Display in (1) and (2). (R) = Red, (O) = Orange, (G) = Green, (W) = White.

Example: Red Upper M2PA-90D21-24ERW
White Lower Red White

* Incandescent lamps are supplied with colored plates (white, red, green, blue, and orange) and legend plates (milk-white and transparent). Use the appropriate combination.

M2PT (Round) Single Screen Models



Case color		Light gray	Display color symbol
LED	5 VDC	M2PT-90A12-05C(1)	ROGW
	12 VDC	M2PT-90A12-12C(1)	
	24 VDC	M2PT-90A12-24C(1)	
Incandescent lamp	28 VDC/VAC	M2PT-90A12-28	*

Note: Enter the desired color symbol for the Display in (1). (R) = Red, (O) = Orange, (G) = Green, (W) = White.

Example: Red M2PT-90A12-24CR

* Incandescent lamps are supplied with a colored plates (white, red, green, blue, and orange). Use the appropriate combination. Models A3PT and M2PT (round models), however, are not supplied with legend plates.

Individual models: Refer to pages 6 to 8.
(The Display, Lamp, and Socket can be ordered separately.)

■ Specifications: Refer to the A3P.
■ Dimensions: Refer to page 11. Accessories: Refer to the A3P.

Ordering Information

Illumination-only and Colored-illumination LED Models

“Illumination only” describes LED models for which the screen color is the same whether the LED is lit or not. The screen simply becomes brighter when the LED lights.

Example: Red LED

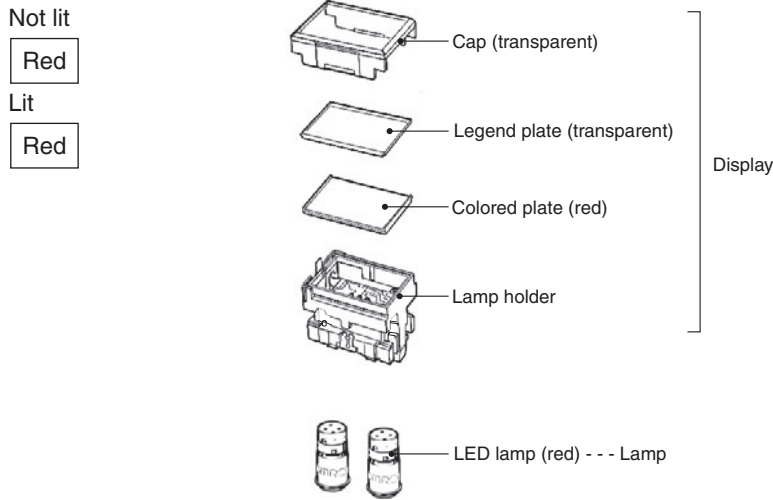

“Colored illumination” describes LED models for which the screen color is white when the LED is not lit and changes to the color of the LED lamp when the LED is lit.

Example: Red LED

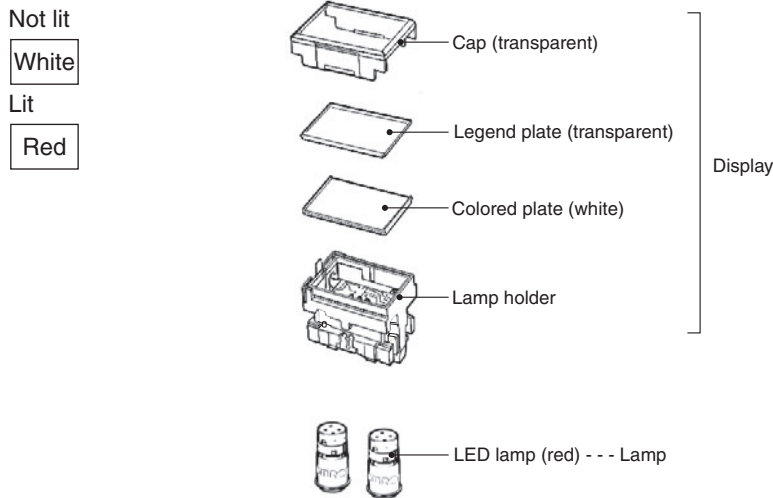

Ordering: For a colored-illumination Indicator, order the Display, Lamp, and Socket as shown in the following table.

Display	Lamp	Socket
<ul style="list-style-type: none"> Select the LED lamp-lighted model required from the selection on page 7. Each assembly includes the number of white colored plates required to enable colored illumination for the corresponding screen-split configuration. For example, 4-split screen models includes 4 white colored plates. 	<ul style="list-style-type: none"> Select the LED lamps to suit your desired coloration from the selection on page 8. Number of necessary LED lamps (standard): M2PJ (rectangular): 4 M2PA (square): 2 M2PT (round): 2 	<ul style="list-style-type: none"> Select from the Sockets on page 8.

Ordering Information

Ordering Individually Displays, Lamps, and Sockets can be ordered separately. Combinations that are not available as sets can be created using individual Units. Also, store the parts as spares for maintenance and repairs.

LED-lighted/Chameleon Models (LED is built into the Display.)

Display

Round (M2PT) models not available.

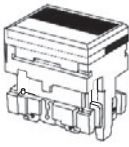

- M2P□-5□□□-□□E
(for Indicator)

LED Lamp-lighted Models (LED lamp and Display are separate.)

Display

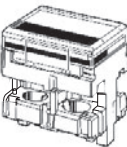

- M2P□-502□
(for Indicator)

Incandescent Lamp-lighted Models (Incandescent lamp and Display are separate.)

Display

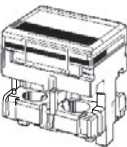

- M2P□-501□
(for Indicator)



Lamp (LED Lamp) *1



SLL-□□E□

Lamp (Incandescent Lamp) *2



- Standard lamp: SLL-□□
- Low-power lamp: SLL-□□H

Socket *

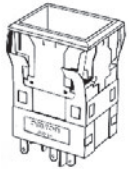

- M2P□-7□□□-□
(for Indicator)

Socket *

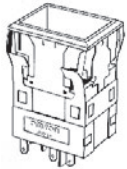

- M2P□-7□□□-□
(for Indicator)

Socket *

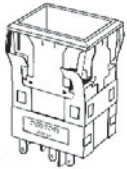

- M2P□-7□□□-□
(for Indicator)

* The Socket is compatible with LED-lighted, LED lamp-lighted, and incandescent lamp-lighted models.

*1. Number of necessary LED lamps.

Screen pattern	M2PJ	M2PA	M2PT
Single screen	4	2	2
Horizontal 2-split screen		2	---
Vertical 2-split screen		---	---
Vertical 3-split screen		---	---
Horizontal 3-split screen		---	---
4-split screen		---	---

*2. Number of necessary incandescent lamps.

Screen pattern	M2PJ	M2PA	M2PT
Single screen	2	1	2
Horizontal 2-split screen	4 (low-power incandescent lamp)	2	---
Vertical 2-split screen		---	---
Vertical 3-split screen		---	---
Horizontal 3-split screen		---	---
4-split screen	---	---	---

Ordering set combinations: Refer to pages 3 to 4.











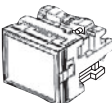

■ Specifications: Refer to the A3P.
■ Dimensions: Refer to page 11. Accessories: Refer to the A3P.

Ordering Information

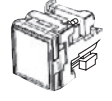
Ordering IndividuallyDisplays, Lamps, and Sockets can be ordered separately. Combinations that are not available as sets can be created using individual Units. Also, store the parts as spares for maintenance and repairs.









Display

LED-lighted Models (LED is built-in.)

Appearance	Split-screen color (color symbol)	White (W)	Red (R)	Green (G)	Orange (O)	Selection precautions	
Rectangular models 	Single screen		M2PJ-5701-□□E	M2PJ-5702-□□E	M2PJ-5703-□□E	M2PJ-5706-□□E	<ul style="list-style-type: none"> Enter the voltage to be used in the □□ at the end of the model number. Examples of voltage used: 5 V=0 5 E 12 V=1 2 E 24 V=2 4 E Horizontal 2-split screen models support only 24V. For the color of the shaded part, select the model according to the colors given at the top of the table.
	Horizontal 2- 2 split screen		M2PJ-5711-□□E	M2PJ-5712-□□E	M2PJ-5713-□□E	M2PJ-5716-□□E	
			M2PJ-5721-□□E	M2PJ-5722-□□E	M2PJ-5723-□□E	M2PJ-5726-□□E	
			M2PJ-5731-□□E	M2PJ-5732-□□E	M2PJ-5733-□□E	M2PJ-5736-□□E	
			M2PJ-5741-□□E	M2PJ-5742-□□E	M2PJ-5743-□□E	M2PJ-5746-□□E	
Square models 	Single screen		M2PA-5701-□□E	M2PA-5702-□□E	M2PA-5703-□□E	M2PA-5706-□□E	
	Horizontal 2-split screen		M2PA-5711-□□E	M2PA-5712-□□E	M2PA-5713-□□E	M2PA-5716-□□E	
			M2PA-5721-□□E	M2PA-5722-□□E	M2PA-5723-□□E	M2PA-5726-□□E	
			M2PA-5731-□□E	M2PA-5732-□□E	M2PA-5733-□□E	M2PA-5736-□□E	
			M2PA-5741-□□E	M2PA-5742-□□E	M2PA-5743-□□E	M2PA-5746-□□E	

Note: 1. A cap, legend plate (transparent), colored plate, white plunger case, and LED (with a current-limiting resistor) are built into the standard lighting unit.
2. Split-screen coloring configurations are given with the "OMRON" mark on the Sockets facing down.

LED Lamp-lighted Models (LED is not built-in.)

Model	Rectangular models	Square models	Round models	Selection precautions																																						
Screen pattern	Screen	Model	Screen	Model	Screen	Model	<ul style="list-style-type: none"> Colored plates (white, red, green, and orange), a legend plate (transparent), and a light baffle (split-screen models only) are included. Use the appropriate combination for the LED coloring required. The number of white colored plates required to enable colored illumination for the corresponding screen-split configuration is included. (For example, 4-split screen models include 4 white colored plates). The number of colored plates included for each model are shown in the following table. <table border="1"> <thead> <tr> <th>Screen pattern</th> <th>White</th> <th>Red</th> <th>Green</th> <th>Orange</th> </tr> </thead> <tbody> <tr> <td>Single screen</td> <td>1</td> <td>1</td> <td>1</td> <td>1</td> </tr> <tr> <td>Horizontal 2-split screen</td> <td>2</td> <td>1</td> <td>1</td> <td>1</td> </tr> <tr> <td>Horizontal 3-split screen</td> <td>3</td> <td>2</td> <td>2</td> <td>2</td> </tr> <tr> <td>Vertical 2-split screen</td> <td>2</td> <td>1</td> <td>1</td> <td>1</td> </tr> <tr> <td>Vertical 3-split screen</td> <td>3</td> <td>2</td> <td>2</td> <td>2</td> </tr> <tr> <td>4-split screen</td> <td>4</td> <td>1</td> <td>1</td> <td>1</td> </tr> </tbody> </table>	Screen pattern	White	Red	Green	Orange	Single screen	1	1	1	1	Horizontal 2-split screen	2	1	1	1	Horizontal 3-split screen	3	2	2	2	Vertical 2-split screen	2	1	1	1	Vertical 3-split screen	3	2	2	2	4-split screen	4	1	1	1
Screen pattern	White	Red	Green	Orange																																						
Single screen	1	1	1	1																																						
Horizontal 2-split screen	2	1	1	1																																						
Horizontal 3-split screen	3	2	2	2																																						
Vertical 2-split screen	2	1	1	1																																						
Vertical 3-split screen	3	2	2	2																																						
4-split screen	4	1	1	1																																						
Single screen		M2PJ-5021		M2PA-5021		M2PT-5021																																				
Horizontal 2-split screen		M2PJ-5022		M2PA-5022	---	---																																				
Vertical 2-split screen		M2PJ-5023	---	---	---	---																																				
Horizontal 3-split screen		M2PJ-5024	---	---	---	---																																				
Vertical 3-split screen		M2PJ-5025	---	---	---	---																																				
4-split screen		M2PJ-5026	---	---	---	---																																				

Ordering set combinations: Refer to pages 3 to 4.

■ Specifications: Refer to the A3P.

■ Dimensions: Refer to page 11. Accessories: Refer to the A3P.

Ordering Information

Ordering IndividuallyDisplays, Lamps, and Sockets can be ordered separately. Combinations that are not available as sets can be created using individual Units. Also, store the parts as spares for maintenance and repairs.

Display

Incandescent Lamp-lighted Models (Incandescent lamp is not built-in.)

Model	Rectangular models	Square models	Round models	Selection precautions		
Screen pattern	Screen	Model	Model	Model	Model	Model
Single screen		M2PJ-5011		M2PA-5011		M2PT-5011 *
Horizontal 2-split screen		M2PJ-5012		M2PA-5012	---	---
Vertical 2-split screen		M2PJ-5013	---	---	---	---
Horizontal 3-split screen		M2PJ-5014	---	---	---	---
Vertical 3-split screen		M2PJ-5015	---	---	---	---
4-split screen		M2PJ-5016	---	---	---	---

• Colored plates (white, red, green, orange, and blue), a legend plate (transparent), and a light baffle (split-screen models only) are supplied.
 * M2PT (round) models do not contain a legend plate.
 • The number of colored plates supplied is shown in the following table.

Screen pattern	White	Red	Green	Orange	Blue
Single screen	1	1	1	1	1
Horizontal 2-split screen	1	1	1	1	1
Vertical 2-split screen	1	1	1	1	1
Horizontal 3-split screen	2	2	2	2	2
Vertical 3-split screen	2	2	2	2	2
4-split screen	2	2	2	2	2

Chameleon Models (with Built-in LED)

Shape	Rated voltage	Chameleon indicator
Rectangular	12 VDC	M2PJ-5800-12E
	24 VDC	M2PJ-5800-24E
Square	12 VDC	M2PA-5800-12E
	24 VDC	M2PA-5800-24E

Note: 1. With the chameleon models, the whole screen lights red, green, or orange (i.e., red and green simultaneously).
 2. A cap, legend plate (transparent), white colored plate, and LED (with a current-limiting resistor) are built into the Display.

Lamp (For mounting, refer to the A3P.)

LED Lamp

Color	Voltage	5 VDC	12 VDC	24 VDC	Applicable cap (color) (colored plate)	Selection precautions
		Model (DC only)	Model (DC only)	Model (DC only)		
Red		SLL-05ER	SLL-12ER	SLL-24ER	Red	In the standard setup, 4 LED lamps are used with M2PJ models and 2 LED lamps are used with M2PA and M2PT models.
Yellow		SLL-05EY	SLL-12EY	SLL-24EY	Orange	
Green		SLL-05EG	SLL-12EG	SLL-24EG	Green	
White		SLL-05EW	SLL-12EW	SLL-24EW	White	

Incandescent Lamp

Voltage	Lamp type	Standard lamp	Low-voltage lamp	Selection precautions
5 VAC/VDC		SLL-06	SLL-06H	<ul style="list-style-type: none"> In the standard setup for M2PJ models, 2 lamps are used with single screen models, and 4 lamps are used with split-screen models. If 3 or 4 lamps are lit continuously, use low-power lamps. In the standard setup for M2PA models, 1 lamp is used with single screen models, and 2 lamps are used with split-screen models. In the standard setup for M2PT models, 2 lamps are used.
12 VAC/VDC		SLL-14	SLL-14H	
24 VAC/VDC		SLL-28	SLL-28H	

Socket (common to both incandescent lamp-lighted and LED-lighted models)

Rectangular	Square	Round	Selection precautions
Model	Model	Model	
M2PJ-7010-1	M2PA-7010-1	M2PT-7010-2	<ul style="list-style-type: none"> The end digit denotes the color of the flange: -1 denotes a black flange, and -2 denotes a light gray flange. Round switches are available only in light gray, and not in black.

Ordering set combinations: Refer to pages 3 to 4.

■ Specifications: Refer to the A3P.

■ Dimensions: Refer to page 11. Accessories: Refer to the A3P.

Ordering Information

Accessories

Accessories are the same as those for the A3P Lighted Pushbutton Switches. Refer to the A3P.

LED and Incandescent Lamp Ratings and Characteristics

Ratings and characteristics the same as those for the A3P Lighted Pushbutton Switches. Refer to the A3P.

Approved Standard Ratings

UL (File No. E41515), CSA (File No. LR45258)

LED: 24 VDC max.

























Incandescent lamp: 28 VAC/VDC, 1.2 W max.

Note: Certification has been obtained for the Indicator.

For detailed information on individual products that have received certification, consult your supplier.

Nomenclature

Construction

Lighting method	LED-lighted models (LED is built-in.)		LED lamp-lighted models (LED is not built-in.)				Incandescent lamp-lighted models (Incandescent lamp is not built-in.)			
	M2PJ	M2PA	M2PJ		M2PA	M2PT	M2PJ		M2PA	M2PT
Screen pattern	Single screen 	Single screen 	Single screen 	Vertical 3-split screen 	Single screen 	Single screen 	Single screen 	Vertical 3-split screen 	Single screen 	Single screen 
	Horizontal 2-split screen 	Horizontal 2-split screen 	Horizontal 2-split screen 	Horizontal 3-split screen 	Horizontal 2-split screen 			Horizontal 2-split screen 	Horizontal 3-split screen 	Horizontal 2-split screen 
	Chameleon (3-color) 	Chameleon (3-color) 	Vertical 2-split screen 	4-split screen 				Vertical 2-split screen 	4-split screen 	

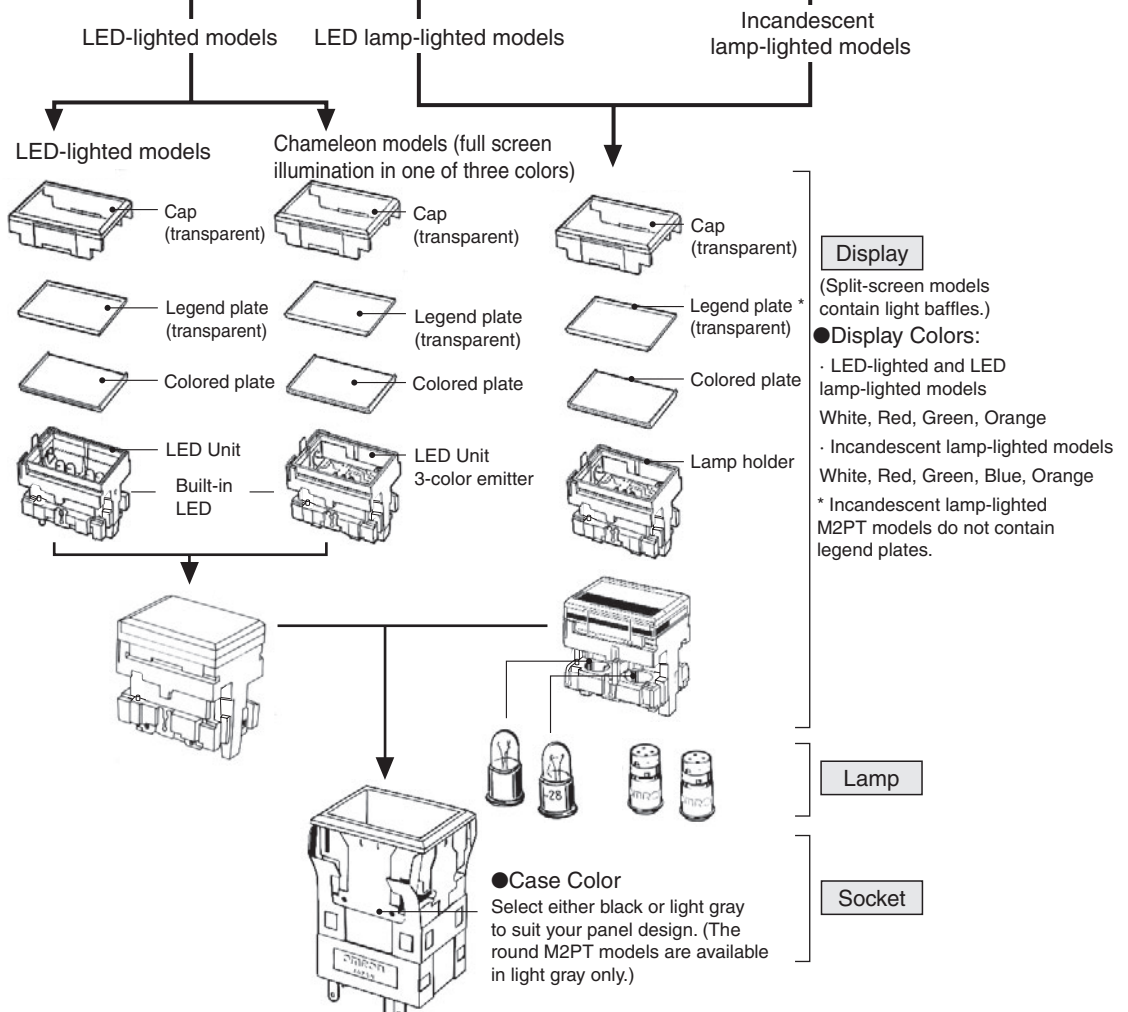

Note: The above diagram for LED lamp-lighted and incandescent lamp-lighted models shows the M2PJ model.

Nomenclature

M2P Lighting Method Diagram

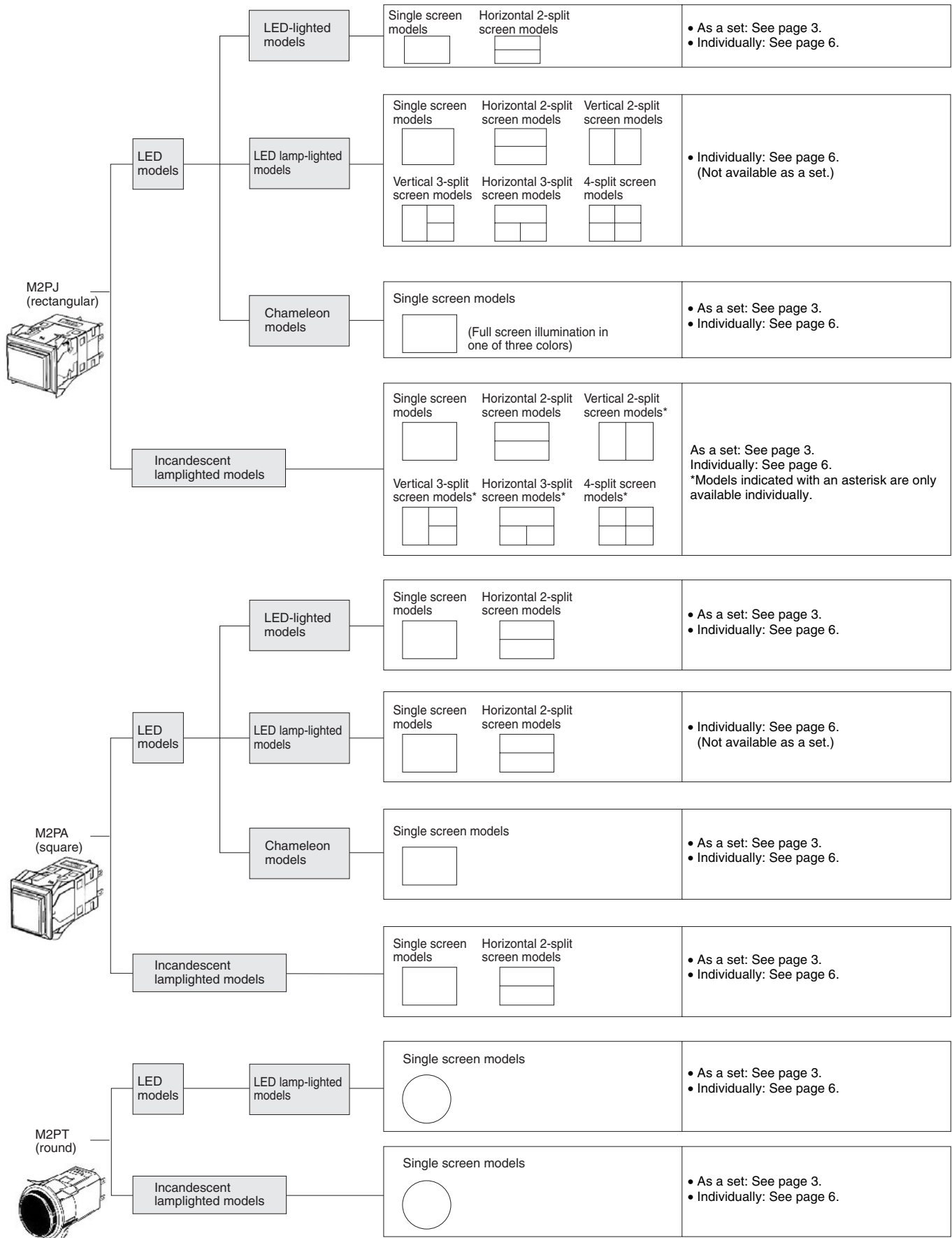

Dimensions

M2PJ (Rectangular) Models

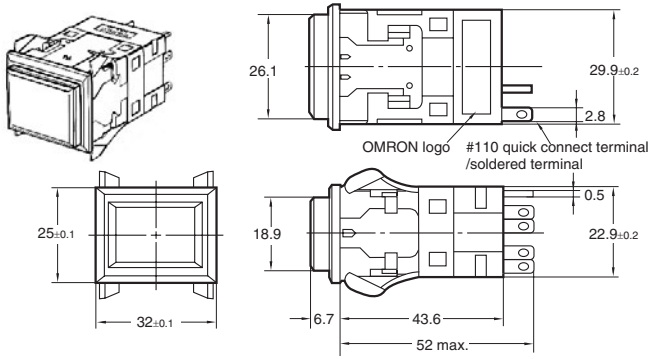

M2PA (Square) Models

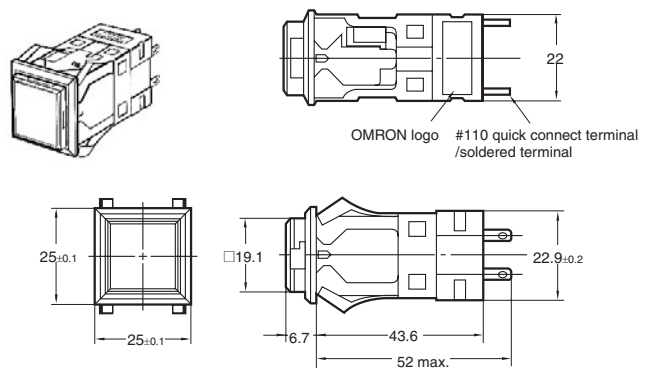

M2PT (Round) Models

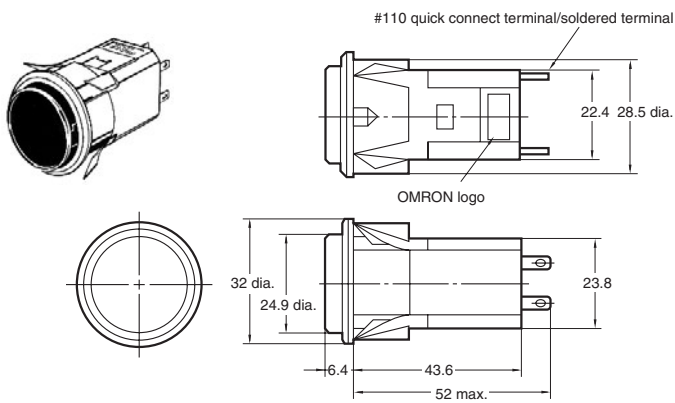

Note: Use a panel thickness of 0.5 mm for tab terminals #110 and solder terminals.

Accessory Mounting Dimensions

Dimensions for mounting accessories are the same as those for the A3P Lighted Pushbutton Switches. Refer to the A3P.

Dimensions

Panel Cutout

M2PJ (Rectangular) Models

Classification	Mounting design	Panel cutout	Remarks
Flange mount models	Individual mounting (Horizontal)		
	Multiple mounting (Horizontal)		
	Individual mounting (Vertical)	Mount to long mounting plate (A3PJ-3002) before use. 	
	Multiple mounting (Vertical)	Mount to long mounting plate (A3PJ-3002) before use. 	
Barrier mount models	Individual mounting (Horizontal)		
	Multiple mounting (Horizontal)		
	Individual mounting (Vertical)	Mount to long mounting plate (A3PJ-3002) before use. 	
	Multiple mounting (Vertical)	Mount to long mounting plate (A3PJ-3002) before use. 	

- Note: 1. n: Number of Units
 2. Recommended panel thickness: 1 to 5 mm
 3. Mount the panel before mounting the Switch Guard.
 4. If the panel is to be finished (e.g., coated), make sure that the panel meets the specified dimensions after the coating.

M2PA (Square) Models

Classification	Mounting design	Panel cutout	Remarks
Flange mount models	Individual mounting		
	Multiple mounting		
Barrier mount models	Individual mounting		
	Multiple mounting		

- Note: 1. n: Number of Units
 2. Recommended panel thickness: 1 to 5 mm
 3. If the panel is to be finished (e.g., coated), make sure that the panel meets the specified dimensions after the coating.



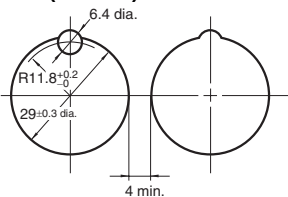









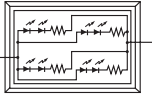

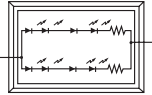
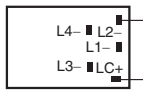
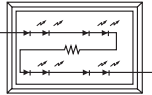
M2PT (Round) Models

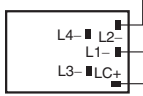
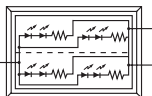
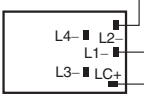
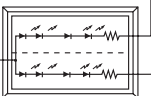

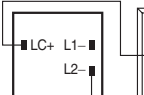
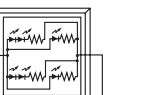
- Note: 1. Recommended panel thickness: 1 to 5 mm
 2. If the panel is to be finished (e.g., coated), make sure that the panel meets the specified dimensions after the coating

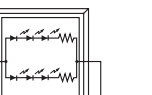
Dimensions

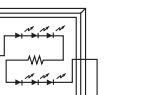
Terminal connections
LED-lighted Models

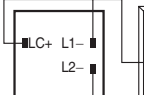
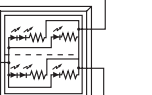
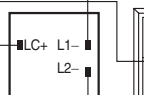
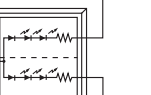
Rated voltage		5 VDC		12 VDC		24 VDC	
Model	Screen pattern						
M2PJ	Single screen 	BOTTOM VIEW 	TOP VIEW 	BOTTOM VIEW 	TOP VIEW 	BOTTOM VIEW 	TOP VIEW 
	2-split screen 	BOTTOM VIEW 	TOP VIEW 	BOTTOM VIEW 		TOP VIEW 	
M2PA	Single screen 	BOTTOM VIEW 	TOP VIEW 	BOTTOM VIEW 	TOP VIEW 	BOTTOM VIEW 	TOP VIEW 
	2-split screen 	BOTTOM VIEW 	TOP VIEW 	BOTTOM VIEW 		TOP VIEW 	

Incandescent Lamp-lighted/LED Lamp-lighted Models

(All are shown with the OMRON logo facing down. The terminal arrangements are the same as for the LED-lighted models.)

Type	Model	Rectangular M2PJ models	Square M2PA models	Round M2PT models
Indicator		BOTTOM VIEW	BOTTOM VIEW	BOTTOM VIEW
		TOP VIEW	TOP VIEW	TOP VIEW
		Terminal arrangement	Terminal arrangement	Terminal arrangement
		Lighting block	Lighting block	Lighting block

LED Chameleon Models

Rated voltage	24 VDC
Model	
Rectangular M2PJ model	
Square M2PA model	

Terminal Arrangement and Coloring Chameleon Models

Wiring	LC+	LC+	LC+
	L1-	L2-	L1- and L2-shorted
Coloring	Green	Red	Orange

Safety Precautions

Refer to *Safety Precautions for All Pushbutton Switches* and *Safety Precautions for the A3P*.

Read and Understand This Catalog

Please read and understand this catalog before purchasing the products. Please consult your OMRON representative if you have any questions or comments.

Warranty and Limitations of Liability

WARRANTY

OMRON's exclusive warranty is that the products are free from defects in materials and workmanship for a period of one year (or other period if specified) from date of sale by OMRON.

OMRON MAKES NO WARRANTY OR REPRESENTATION, EXPRESS OR IMPLIED, REGARDING NON-INFRINGEMENT, MERCHANTABILITY, OR FITNESS FOR PARTICULAR PURPOSE OF THE PRODUCTS. ANY BUYER OR USER ACKNOWLEDGES THAT THE BUYER OR USER ALONE HAS DETERMINED THAT THE PRODUCTS WILL SUITABLY MEET THE REQUIREMENTS OF THEIR INTENDED USE. OMRON DISCLAIMS ALL OTHER WARRANTIES, EXPRESS OR IMPLIED.

LIMITATIONS OF LIABILITY

OMRON SHALL NOT BE RESPONSIBLE FOR SPECIAL, INDIRECT, OR CONSEQUENTIAL DAMAGES, LOSS OF PROFITS OR COMMERCIAL LOSS IN ANY WAY CONNECTED WITH THE PRODUCTS, WHETHER SUCH CLAIM IS BASED ON CONTRACT, WARRANTY, NEGLIGENCE, OR STRICT LIABILITY.

In no event shall the responsibility of OMRON for any act exceed the individual price of the product on which liability is asserted.

IN NO EVENT SHALL OMRON BE RESPONSIBLE FOR WARRANTY, REPAIR, OR OTHER CLAIMS REGARDING THE PRODUCTS UNLESS OMRON'S ANALYSIS CONFIRMS THAT THE PRODUCTS WERE PROPERLY HANDLED, STORED, INSTALLED, AND MAINTAINED AND NOT SUBJECT TO CONTAMINATION, ABUSE, MISUSE, OR INAPPROPRIATE MODIFICATION OR REPAIR.

Application Considerations

SUITABILITY FOR USE

OMRON shall not be responsible for conformity with any standards, codes, or regulations that apply to the combination of products in the customer's application or use of the products.

At the customer's request, OMRON will provide applicable third party certification documents identifying ratings and limitations of use that apply to the products. This information by itself is not sufficient for a complete determination of the suitability of the products in combination with the end product, machine, system, or other application or use.

The following are some examples of applications for which particular attention must be given. This is not intended to be an exhaustive list of all possible uses of the products, nor is it intended to imply that the uses listed may be suitable for the products:

- Outdoor use, uses involving potential chemical contamination or electrical interference, or conditions or uses not described in this catalog.
- Nuclear energy control systems, combustion systems, railroad systems, aviation systems, medical equipment, amusement machines, vehicles, safety equipment, and installations subject to separate industry or government regulations.
- Systems, machines, and equipment that could present a risk to life or property.

Please know and observe all prohibitions of use applicable to the products.

NEVER USE THE PRODUCTS FOR AN APPLICATION INVOLVING SERIOUS RISK TO LIFE OR PROPERTY WITHOUT ENSURING THAT THE SYSTEM AS A WHOLE HAS BEEN DESIGNED TO ADDRESS THE RISKS, AND THAT THE OMRON PRODUCTS ARE PROPERLY RATED AND INSTALLED FOR THE INTENDED USE WITHIN THE OVERALL EQUIPMENT OR SYSTEM.

PROGRAMMABLE PRODUCTS

OMRON shall not be responsible for the user's programming of a programmable product, or any consequence thereof.

Disclaimers

CHANGE IN SPECIFICATIONS

Product specifications and accessories may be changed at any time based on improvements and other reasons.

It is our practice to change model numbers when published ratings or features are changed, or when significant construction changes are made. However, some specifications of the products may be changed without any notice. When in doubt, special model numbers may be assigned to fix or establish key specifications for your application on your request. Please consult with your OMRON representative at any time to confirm actual specifications of purchased products.

DIMENSIONS AND WEIGHTS

Dimensions and weights are nominal and are not to be used for manufacturing purposes, even when tolerances are shown.

PERFORMANCE DATA

Performance data given in this catalog is provided as a guide for the user in determining suitability and does not constitute a warranty. It may represent the result of OMRON's test conditions, and the users must correlate it to actual application requirements. Actual performance is subject to the OMRON Warranty and Limitations of Liability.

ERRORS AND OMISSIONS

The information in this document has been carefully checked and is believed to be accurate; however, no responsibility is assumed for clerical, typographical, or proofreading errors, or omissions.

2010.11

In the interest of product improvement, specifications are subject to change without notice.

OMRON Corporation
Industrial Automation Company

<http://www.ia.omron.com/>

(c)Copyright OMRON Corporation 2010 All Right Reserved.

Mouser Electronics

Authorized Distributor

Click to View Pricing, Inventory, Delivery & Lifecycle Information:

Omron:

[M2PA-5702-24E](#) [M2PA-5706-05E](#) [M2PA-5711-24E](#) [M2PA-7010-1](#) [M2PA-90A12-24EG](#) [M2PA-90A12-24EW](#) [M2PJ-5011](#) [M2PJ-5012](#) [M2PJ-5021](#) [M2PJ-5022](#) [M2PJ-5701-24E](#) [M2PJ-5702-24E](#) [M2PJ-5703-24E](#) [M2PJ-5706-24E](#) [M2PJ-5722-24E](#) [M2PJ-5723-24E](#) [M2PJ-5726-24E](#) [M2PJ-5736-24E](#) [M2PJ-7010-1](#) [M2PJ-7010-2](#) [M2PJ-90A11-24EG](#) [M2PJ-90A11-24EO](#) [M2PJ-90A11-24ER](#) [M2PJ-90A11-24EW](#) [M2PJ-90A21-24EWW](#) [M2PJ-5800-24E](#) [M2PA-5011](#) [M2PA-5706-24E](#) [SLL-14](#)

Данный компонент на территории Российской Федерации

Вы можете приобрести в компании MosChip.

Для оперативного оформления запроса Вам необходимо перейти по данной ссылке:

<http://moschip.ru/get-element>

Вы можете разместить у нас заказ для любого Вашего проекта, будь то серийное производство или разработка единичного прибора.

В нашем ассортименте представлены ведущие мировые производители активных и пассивных электронных компонентов.

Нашей специализацией является поставка электронной компонентной базы двойного назначения, продукции таких производителей как XILINX, Intel (ex.ALTERA), Vicor, Microchip, Texas Instruments, Analog Devices, Mini-Circuits, Amphenol, Glenair.

Сотрудничество с глобальными дистрибьюторами электронных компонентов, предоставляет возможность заказывать и получать с международных складов практически любой перечень компонентов в оптимальные для Вас сроки.

На всех этапах разработки и производства наши партнеры могут получить квалифицированную поддержку опытных инженеров.

Система менеджмента качества компании отвечает требованиям в соответствии с ГОСТ Р ИСО 9001, ГОСТ РВ 0015-002 и ЭС РД 009

Офис по работе с юридическими лицами:

105318, г.Москва, ул.Щербаковская д.3, офис 1107, 1118, ДЦ «Щербаковский»

Телефон: +7 495 668-12-70 (многоканальный)

Факс: +7 495 668-12-70 (доб.304)

E-mail: info@moschip.ru

Skype отдела продаж:

moschip.ru

moschip.ru_4

moschip.ru_6

moschip.ru_9