

PCB terminal block - FK-MPT 0,5/16-3,5 BD:0-F - 1726208

Please be informed that the data shown in this PDF Document is generated from our Online Catalog. Please find the complete data in the user's documentation. Our General Terms of Use for Downloads are valid (<http://phoenixcontact.com/download>)

PCB terminal block, nominal current: 4 A, nom. voltage: 250 V, pitch: 3.5 mm, number of positions: 16, connection method: Push-in spring connection, mounting: Wave soldering, conductor/PCB connection direction: 90 °, color: green

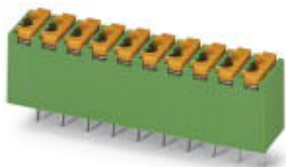

The figure shows a 10-position version of the product

Your advantages

- ✓ Time saving push-in connection, tools not required
- ✓ Defined contact force ensures that contact remains stable over the long term
- ✓ Intuitive use through colour coded actuation lever
- ✓ Potentials can be easily looped through – ideal for BUS applications
- ✓ Small component size for applications where space is at a premium
- ✓ Vertical connection enables multi-row arrangement on the PCB

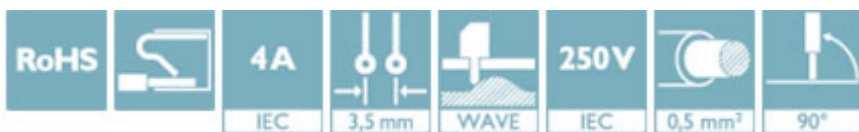

Key Commercial Data

Packing unit	50 pc
GTIN	
GTIN	4046356128629

Technical data

Dimensions

Length [l]	7 mm
Pitch	3.5 mm
Dimension a	52.5 mm
Width [w]	56.5 mm
Height	9.5 mm
Height [h]	13 mm
Solder pin [P]	3.5 mm
Pin spacing	3.5 mm
Hole diameter	1 mm

PCB terminal block - FK-MPT 0,5/16-3,5 BD:0-F - 1726208

Technical data

General

Range of articles	FK-MPT 0,5/...-V
Rated surge voltage (III/3)	2.5 kV
Rated surge voltage (III/2)	2.5 kV
Rated surge voltage (II/2)	2.5 kV
Rated voltage (III/3)	160 V
Rated voltage (III/2)	250 V
Rated voltage (II/2)	250 V
Connection in acc. with standard	EN-VDE
Nominal current I_N	4 A
Nominal cross section	0.5 mm ²
Stripping length	6.5 mm
Number of positions	16

Connection data

Conductor cross section AWG min.	26
Conductor cross section AWG max.	20

Standards and Regulations

Connection in acc. with standard	EN-VDE
	CUL

Environmental Product Compliance

China RoHS	Environmentally friendly use period: unlimited = EFUP-e
	No hazardous substances above threshold values

Drawings

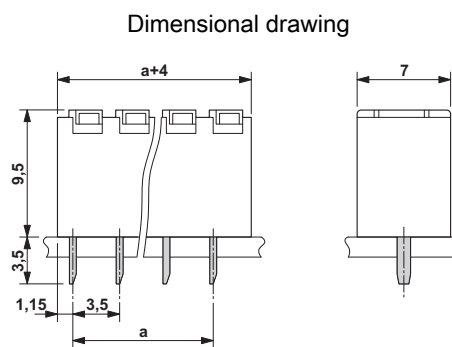
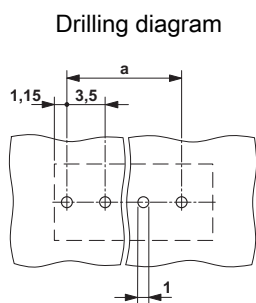

Approvals

Approvals

Approvals

UL Recognized / cUL Recognized / SEV / EAC / cULus Recognized

PCB terminal block - FK-MPT 0,5/16-3,5 BD:0-F - 1726208

Approvals

Ex Approvals

Approval details

UL Recognized		http://database.ul.com/cgi-bin/XYV/template/LISEXT/1FRAME/index.htm	FILE E 60425
	D	B	
Nominal voltage UN	300 V	300 V	
Nominal current IN	4 A	4 A	
mm ² /AWG/kcmil	28-20	28-20	

cUL Recognized		http://database.ul.com/cgi-bin/XYV/template/LISEXT/1FRAME/index.htm	FILE E 60425
	D	B	
Nominal voltage UN	300 V	300 V	
Nominal current IN	4 A	4 A	
mm ² /AWG/kcmil	28-20	28-20	

SEV		https://www.electrosuisse.ch/de/meta/shop/produktezertifikate.html	IK-3558-M2
Nominal voltage UN	160 V		
Nominal current IN	3 A		
mm ² /AWG/kcmil	0.5		

EAC		B.01742
-----	---	---------

cULus Recognized	
------------------	---

Phoenix Contact 2018 © - all rights reserved
<http://www.phoenixcontact.com>

PHOENIX CONTACT GmbH & Co. KG
Flachsmarktstr. 8
32825 Blomberg
Germany
Tel. +49 5235 300
Fax +49 5235 3 41200
<http://www.phoenixcontact.com>

Данный компонент на территории Российской Федерации

Вы можете приобрести в компании MosChip.

Для оперативного оформления запроса Вам необходимо перейти по данной ссылке:

<http://moschip.ru/get-element>

Вы можете разместить у нас заказ для любого Вашего проекта, будь то серийное производство или разработка единичного прибора.

В нашем ассортименте представлены ведущие мировые производители активных и пассивных электронных компонентов.

Нашей специализацией является поставка электронной компонентной базы двойного назначения, продукции таких производителей как XILINX, Intel (ex.ALTERA), Vicor, Microchip, Texas Instruments, Analog Devices, Mini-Circuits, Amphenol, Glenair.

Сотрудничество с глобальными дистрибьюторами электронных компонентов, предоставляет возможность заказывать и получать с международных складов практически любой перечень компонентов в оптимальные для Вас сроки.

На всех этапах разработки и производства наши партнеры могут получить квалифицированную поддержку опытных инженеров.

Система менеджмента качества компании отвечает требованиям в соответствии с ГОСТ Р ИСО 9001, ГОСТ РВ 0015-002 и ЭС РД 009

Офис по работе с юридическими лицами:

105318, г.Москва, ул.Щербаковская д.3, офис 1107, 1118, ДЦ «Щербаковский»

Телефон: +7 495 668-12-70 (многоканальный)

Факс: +7 495 668-12-70 (доб.304)

E-mail: info@moschip.ru

Skype отдела продаж:

moschip.ru

moschip.ru_4

moschip.ru_6

moschip.ru_9