

BRUSH LESS DC MOTOR PRE-DRIVER

■GENERAL DESCRIPTION

The **NJM2624A** is a 3-phase brushless DC motor pre-driver which requires external power-transistors suited to drive current of the motor.

The Run Enable function is used as PWM control besides of ON/OFF switched function.

■PACKAGE OUTLINE

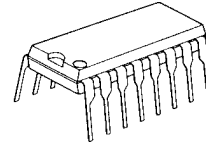

NJM2624AD

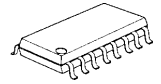

NJM2624AM

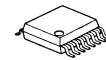

NJM2624AV

■FEATURES

- Operating Voltage (V⁺=4.5V to 18V)
- Low Operating Current (10mA max.)
- Run Enable
- Forward or Reverse Direction
- Output Switch Current (90mA typ.)
- Bipolar Technology
- Package Outline DIP16, DMP16, SSOP16

■PIN CONFIGURATION

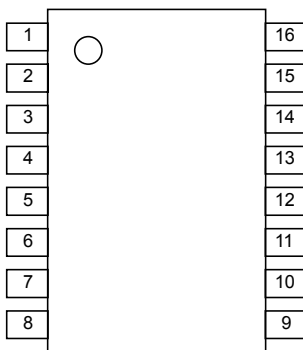

PIN FUNCTION

1.H1-	9.GND
2.H1+	10.ON/OFF
3.H2+	11.OUT1
4.H2-	12.OUT3
5.H3-	13.OUT5
6.H3+	14.OUT6
7.FR	15.OUT4
8.V ⁺	16.OUT2

NJM2624A

■BLOCK DIAGRAM

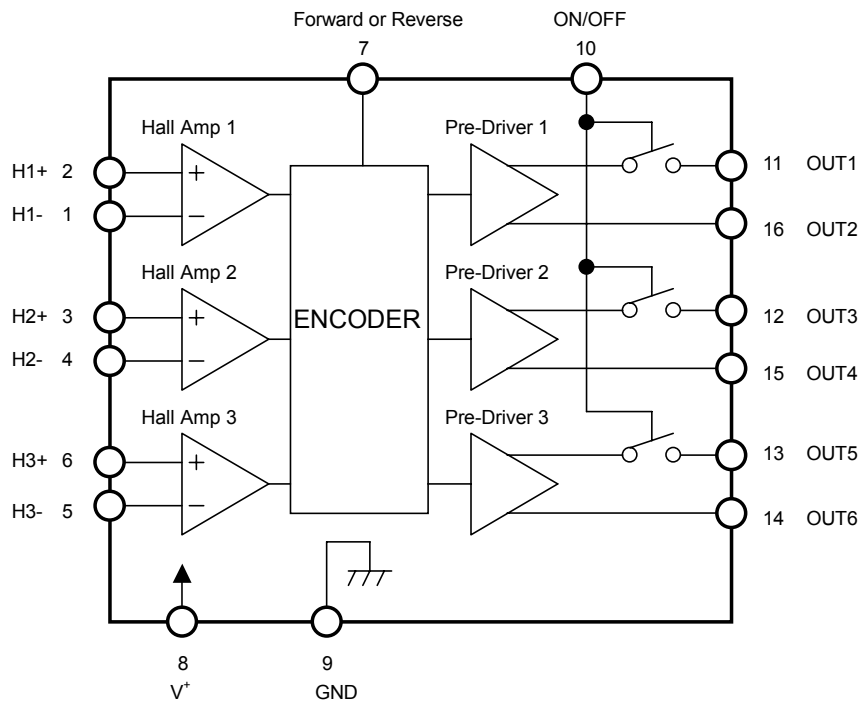

■ABSOLUTE MAXIMUM RATINGS (Ta=25°C)

PARAMETER	SYMBOL	RATINGS	UNIT
Supply Voltage	V ⁺	20	V
Output Current	I _o	100	mA
Power Dissipation	P _D	(DIP16) 700 (DMP16) 350 (SSOP16) 300	mW
Operating Temperature Range	Topr	-25 ~ +85	°C
Storage Temperature Range	Tstg	-40 ~ +150	°C

■ELECTRICAL CHARACTERISTICS (V⁺=12V, Ta=25°C)

Total Device

PARAMETER	SYMBOL	TEST CONDITONS	MIN.	TYP.	MAX.	UNIT
Supply Voltage	V ⁺		4.5	–	18	V
Supply Current	I _{CC}	RL=∞ ON/OFF Terminal=OPEN	–	3.7	10	mA

Hall Sensor Section

Input Offset Voltage	V _{IO}	RL=470Ω	-4.2	–	4.2	mV
Input Common mode Voltage range	V _{ICM}	RL=470Ω	1.5	–	10.5	V
Input Bias Current	I _B		–	–	600	nA

Output Section

Output Voltage 1	V _{OUT1}	RL=470Ω, V ⁺ =12V	8.9	9.5	–	V
Output Voltage 2	V _{OUT2}	RL=470Ω, V ⁺ =5V	–	3.5	–	V
Maximum Output Current 1	I _{OUT1}	RL=100Ω, V ⁺ =12V	50	90	–	mA
Maximum Output Current 2	I _{OUT2}	RL=100Ω, V ⁺ =5V	–	30	–	mA
Output Leak Current	I _{LEAK}		–	–	5	μA

Run Enable Section

Run Enable Voltage	V _{ON}	RL=470Ω	1/2V ⁺ +0.5	–	–	V
Run Disable Voltage	V _{OFF}	RL=470Ω	–	–	1/2V ⁺ -0.5	V
Output Voltage Undefined Area	V _{O-undef}	RL=470Ω	1/2V ⁺ -0.5	1/2V ⁺	1/2V ⁺ +0.5	V
Source Current 1	I _{ON1}	ON/OFF Terminal=GND	–	250	400	μA

Forward or Reverse Direction Section

Forward Direction	V _F	RL=470Ω	1/2V ⁺ +0.5	–	–	V
Reverse Direction	V _R	RL=470Ω	–	–	1/2V ⁺ -0.5	V
F/R Logic Undefined Area	V _{SW-undef}	RL=470Ω	1/2V ⁺ -0.5	1/2V ⁺	1/2V ⁺ +0.5	V
Source Current 2	I _{ON2}	Forward or Reverse Terminal=GND	–	250	400	μA

NJM2624A

■ TERMINAL DESCRIPTION

Pin No,	SYMBOL	FUNCTION	INSIDE EQUIVALENT CIRCUIT
2	H1+	Sensor Input 1 Non-Inverting Terminal	
3	H2+	Sensor Input 2 Non-Inverting Terminal	
6	H3+	Sensor Input 3 Non-Inverting Terminal	
1	H1-	Sensor Input 1 Inverting Terminal	
4	H2-	Sensor Input 2 Inverting Terminal	
5	H3-	Sensor Input 3 Inverting Terminal	
7	F/R	Forward or Reverse Direction Terminal	

■ TERMINAL DESCRIPTION

Pin No,	SYMBOL	FUNCTION	INSIDE EQUIVALENT CIRCUIT
8	V ⁺	Power Supply	-
9	GND	Ground	-
10	ON/OFF	Output Run Enable Terminal	
11	OUT1	Internal Switching Transistor Emitter Follower	
16	OUT2		
12	OUT3		
15	OUT4		
13	OUT5		
14	OUT6		

NJM2624A

■TYPICAL APPLICATION

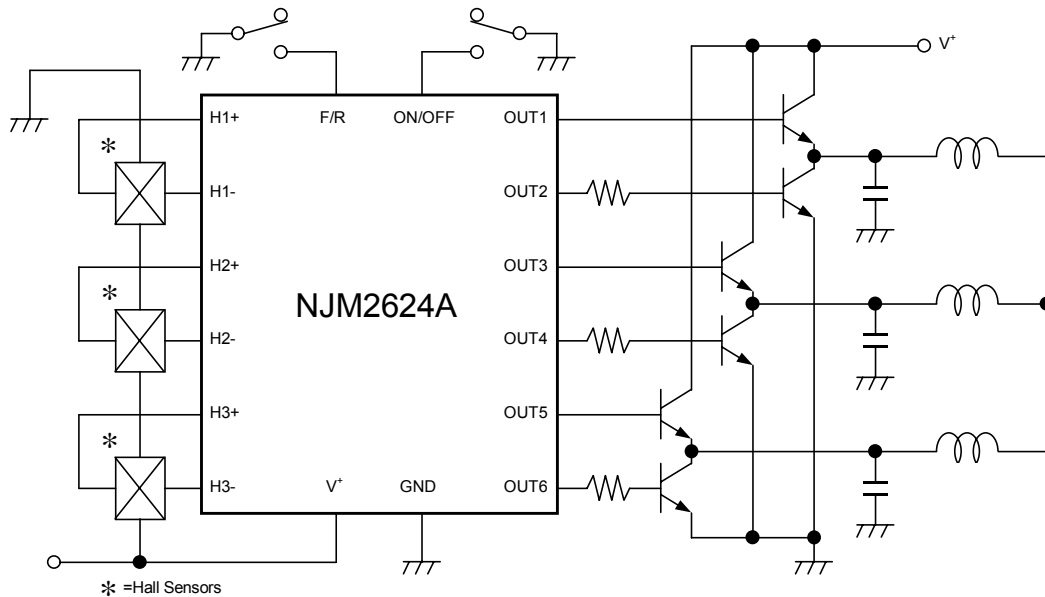

■TIMING CHART

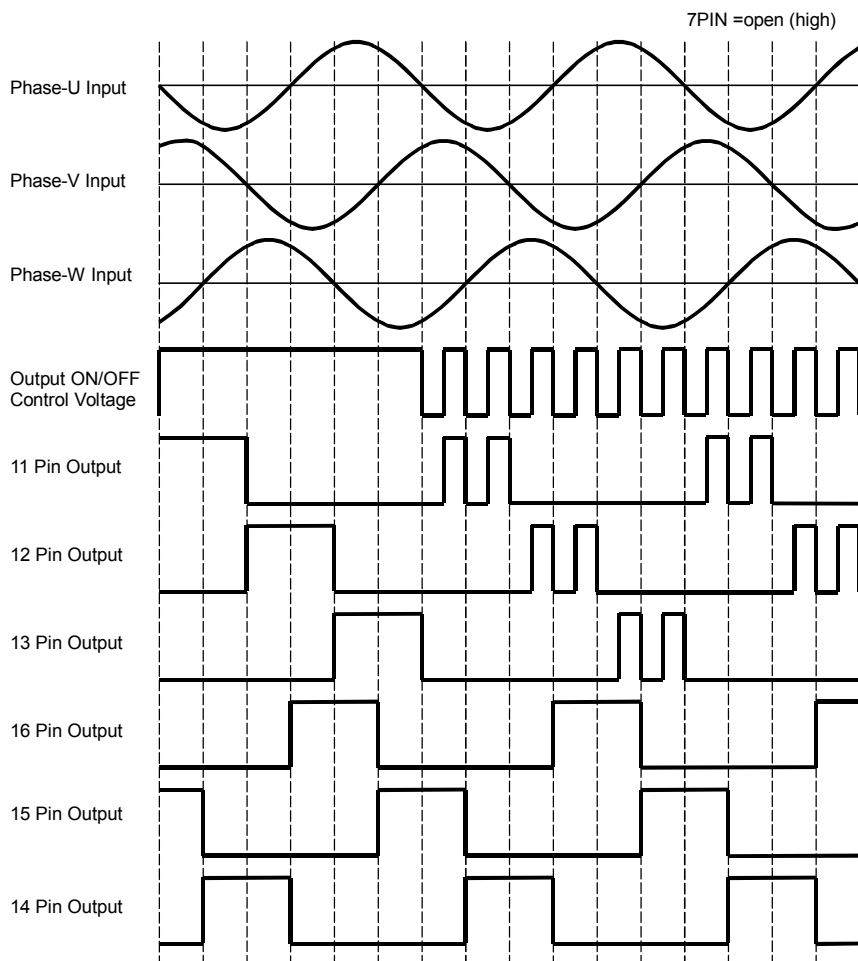

TYPICAL CHARACTERISTICS

Supply Current vs. Supply Voltage
($T_a=25^\circ\text{C}$)

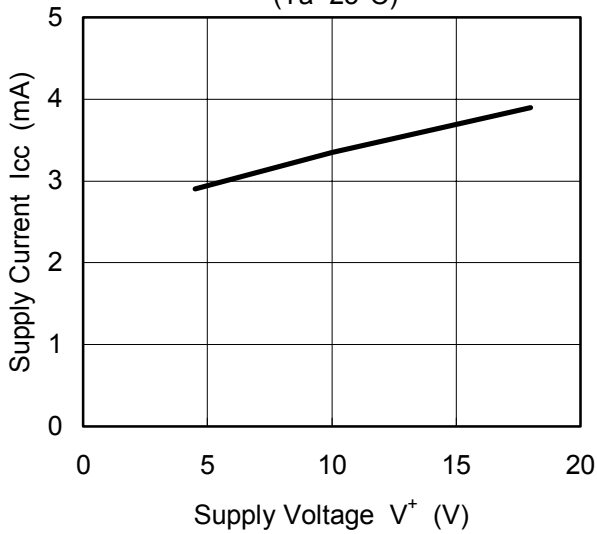

Input vs. Output (Offset)
($V^+=12\text{V}, R_L=470\ \Omega, T_a=25^\circ\text{C}$)

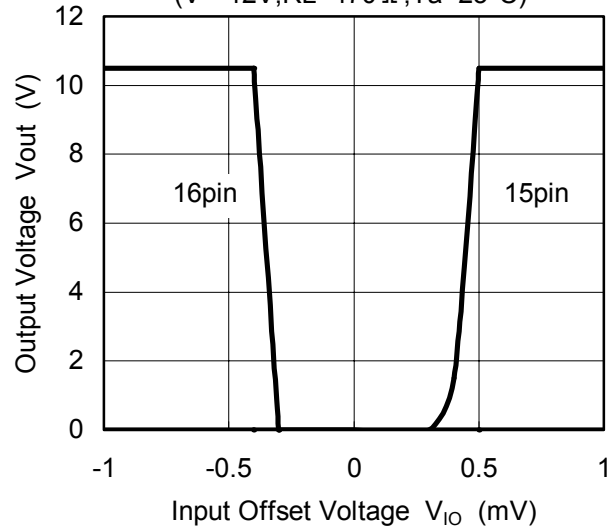

Input Bias Current vs. Supply Voltage
(Input= $1/2V^+, T_a=25^\circ\text{C}$)

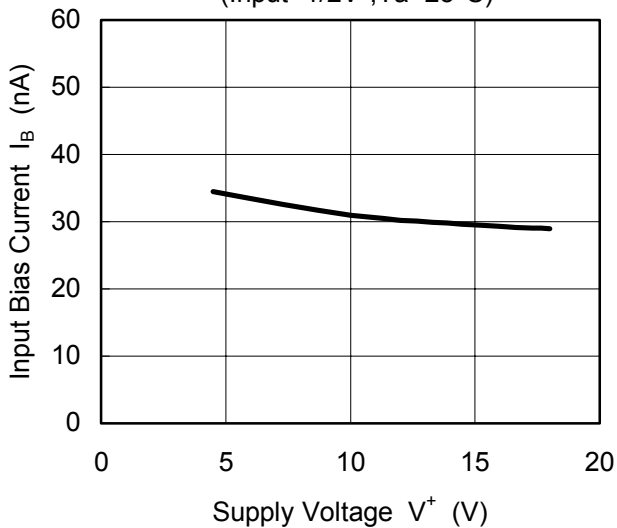

Output Voltage vs. Forward or Reverse Voltage
($V^+=12\text{V}, R_L=470\ \Omega, T_a=25^\circ\text{C}$)

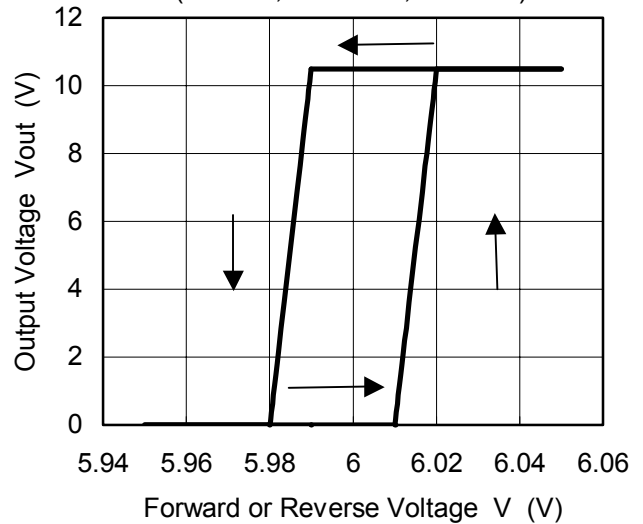

Output Voltage vs. Output ON/OFF Voltage
($V^+=12\text{V}, R_L=470\ \Omega, T_a=25^\circ\text{C}$)

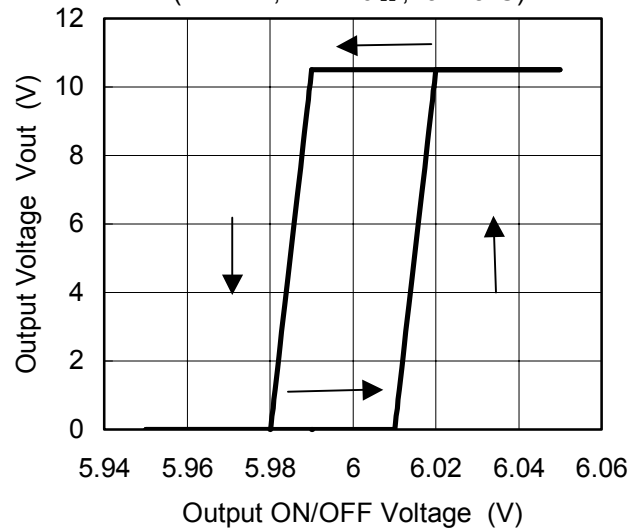

TYPICAL CHARACTERISTICS

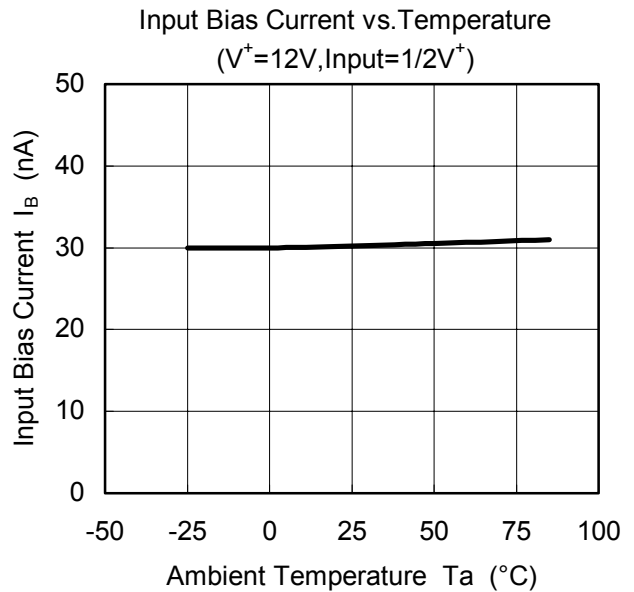
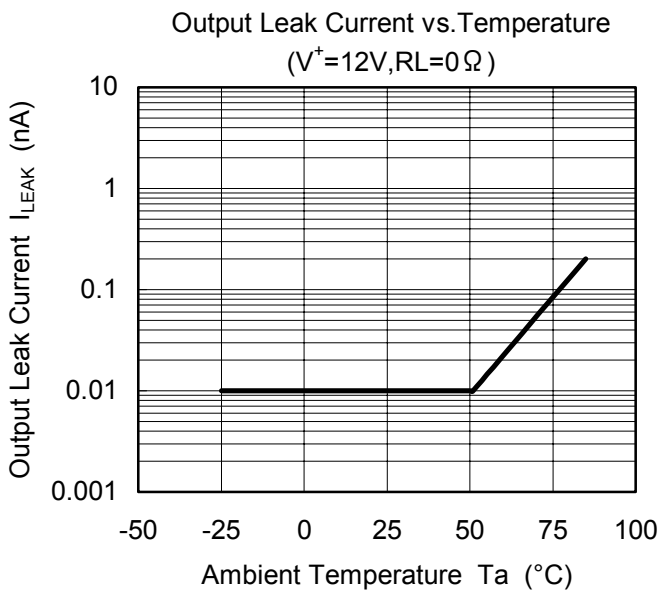
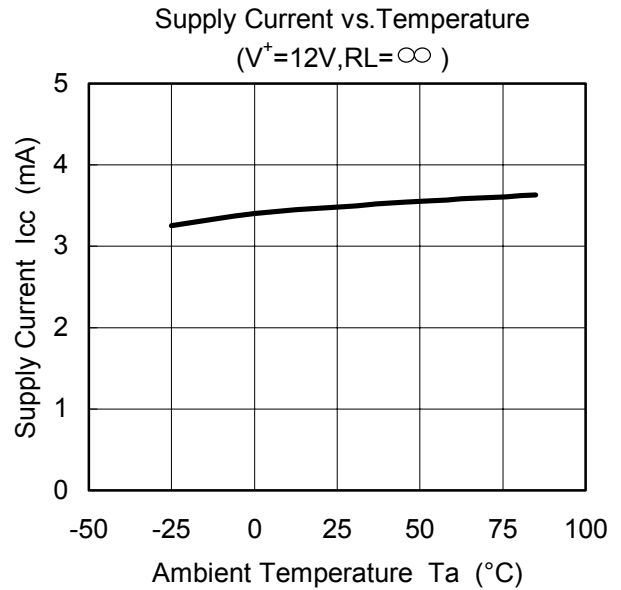
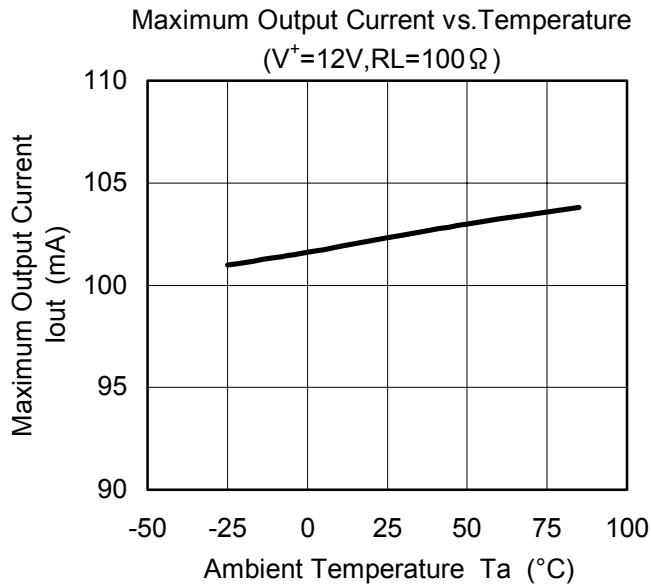

[CAUTION]

The specifications on this databook are only given for information, without any guarantee as regards either mistakes or omissions. The application circuits in this databook are described only to show representative usages of the product and not intended for the guarantee or permission of any right including the industrial rights.

Данный компонент на территории Российской Федерации

Вы можете приобрести в компании MosChip.

Для оперативного оформления запроса Вам необходимо перейти по данной ссылке:

<http://moschip.ru/get-element>

Вы можете разместить у нас заказ для любого Вашего проекта, будь то серийное производство или разработка единичного прибора.

В нашем ассортименте представлены ведущие мировые производители активных и пассивных электронных компонентов.

Нашей специализацией является поставка электронной компонентной базы двойного назначения, продукции таких производителей как XILINX, Intel (ex.ALTERA), Vicor, Microchip, Texas Instruments, Analog Devices, Mini-Circuits, Amphenol, Glenair.

Сотрудничество с глобальными дистрибьюторами электронных компонентов, предоставляет возможность заказывать и получать с международных складов практически любой перечень компонентов в оптимальные для Вас сроки.

На всех этапах разработки и производства наши партнеры могут получить квалифицированную поддержку опытных инженеров.

Система менеджмента качества компании отвечает требованиям в соответствии с ГОСТ Р ИСО 9001, ГОСТ РВ 0015-002 и ЭС РД 009

Офис по работе с юридическими лицами:

105318, г.Москва, ул.Щербаковская д.3, офис 1107, 1118, ДЦ «Щербаковский»

Телефон: +7 495 668-12-70 (многоканальный)

Факс: +7 495 668-12-70 (доб.304)

E-mail: info@moschip.ru

Skype отдела продаж:

moschip.ru

moschip.ru_4

moschip.ru_6

moschip.ru_9