

# WiFi + GPS Multiband Ceramic Chip Antenna

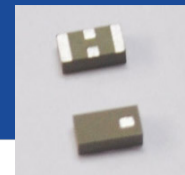

ACAG0301-15752450-T



3.2 x 1.6 x 1.2mm  
RoHS/RoHS II Compliant  
MSL = 1

## FEATURES

- Made using LTCC (low temperature co-fired ceramic) technology
- Gain of 1.21dBi | 3.18dBi
- 1575MHz and 2450MHz frequency bands
- Small form factor 3.2 x 1.6 x 1.2mm
- Omni-directional

## APPLICATIONS

- IoT and wearable
- GPS devices
- Wifi
- Bluetooth
- ISM applications

## ELECTRICAL CHARACTERISTICS

Item	Specification	
Frequency	1575 MHz	2450 MHz
Bandwidth	20 MHz typ ( 1565~1585 MHz )	100 MHz ( 2400~2500 MHz )
Peak Gain	1.21 dBi	3.18 dBi
Return Loss	≥10 dB	
Impedance	50 Ω	
Operating Temperature Range	-40°C to + 85°C	

## MECHANICAL DIMENSION (mm)

### Antenna Dimension

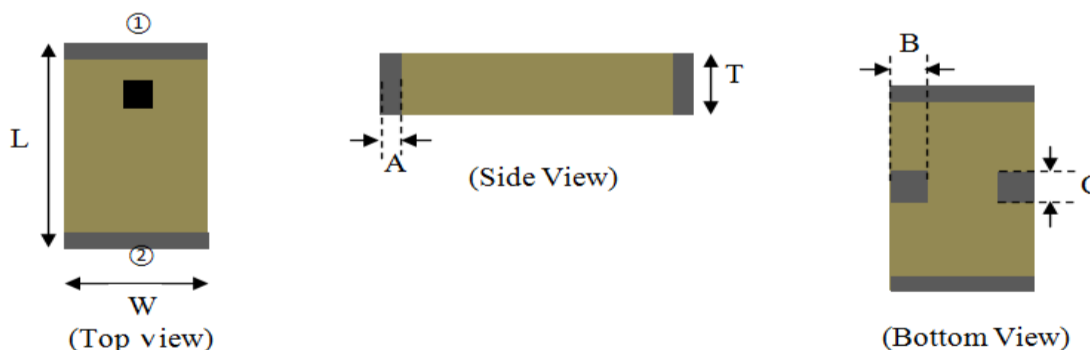

Number	Terminal Name	Number	Terminal Name
①	INPUT-GPS	③	GND
②	INPUT-2.4GHz	④	GND

Symbols	L	W	T	A	B	C
Dimensions	3.2+/-0.2	1.6+/-0.2	1.2+/-0.15	0.2+/-0.15	0.5+/-0.15	0.47+/-0.15



# WiFi + GPS Multiband Ceramic Chip Antenna

ACAG0301-15752450-T

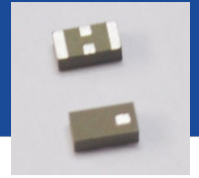

3.2 x 1.6 x 1.2mm  
RoHS/RoHS II Compliant

MSL = 1

## ANTENNA RESPONSE – RETURN LOSS S11

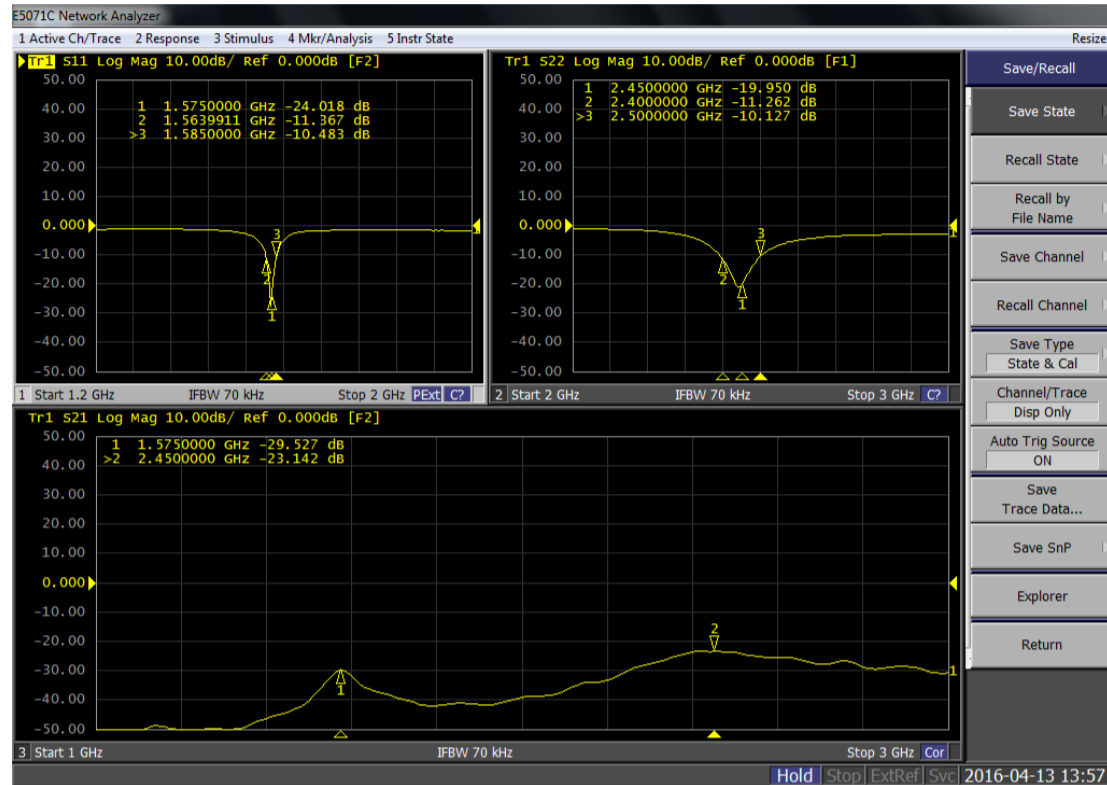

## RADIATION PATTERNS

### Coordinates

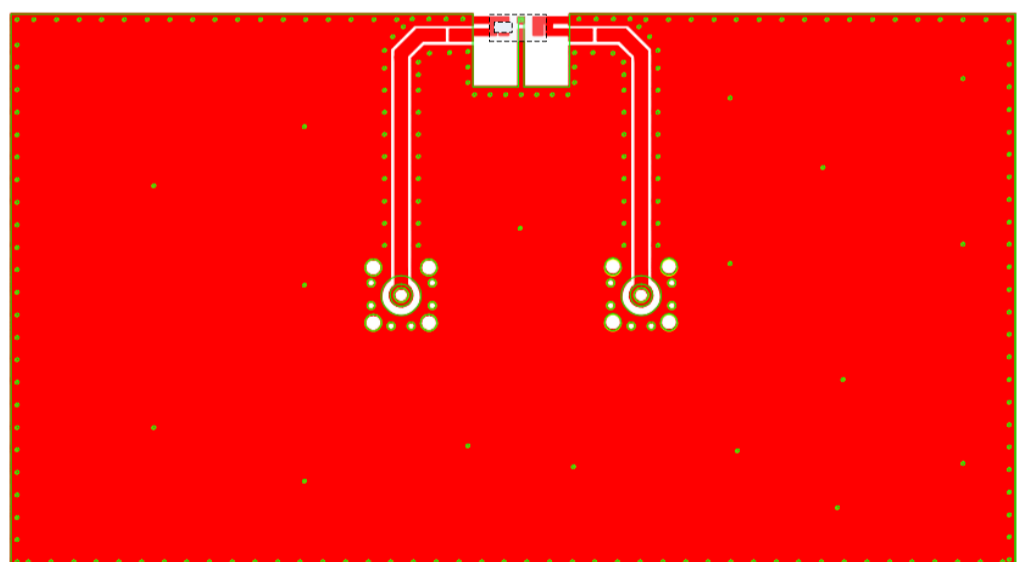
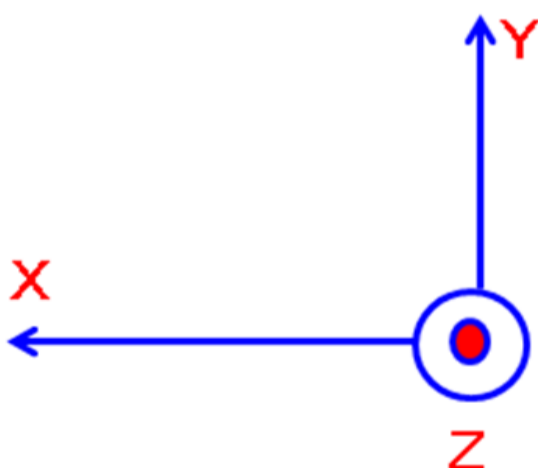

# WiFi + GPS Multiband Ceramic Chip Antenna

ACAG0301-15752450-T

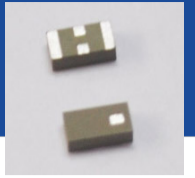

3.2 x 1.6 x 1.2mm  
RoHS/RoHS II Compliant

MSL = 1

## RADIATION PATTERNS

### GPS X-Z Plane

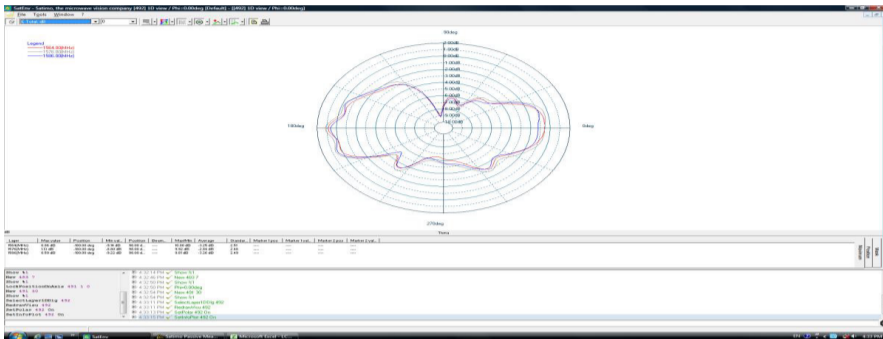

### GPS Y-Z Plane

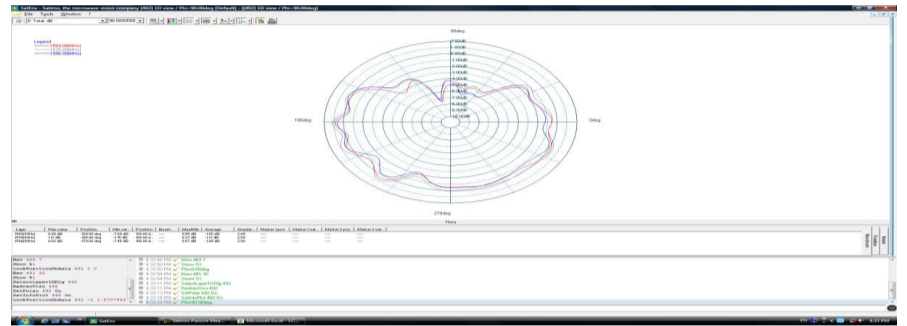

### GPS X-Y Plane

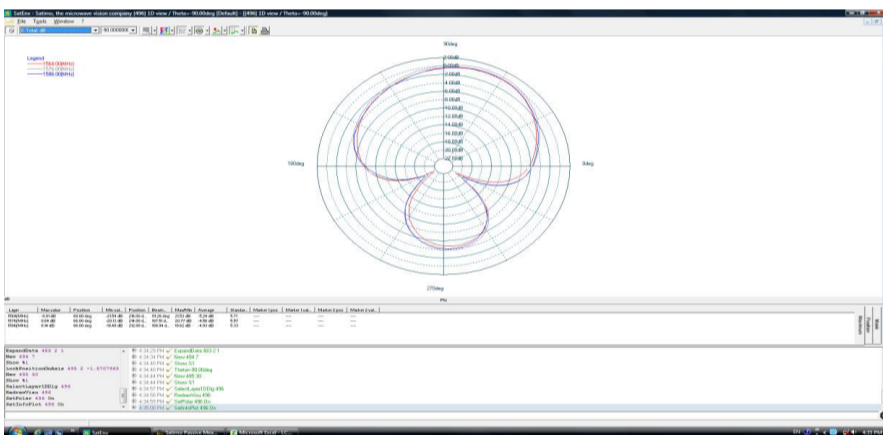

### 2.45G X-Z Plane

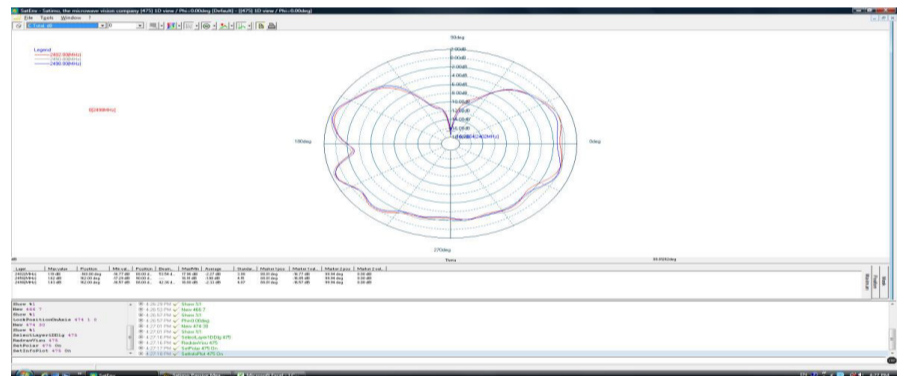

### 2.45G Y-Z Plane

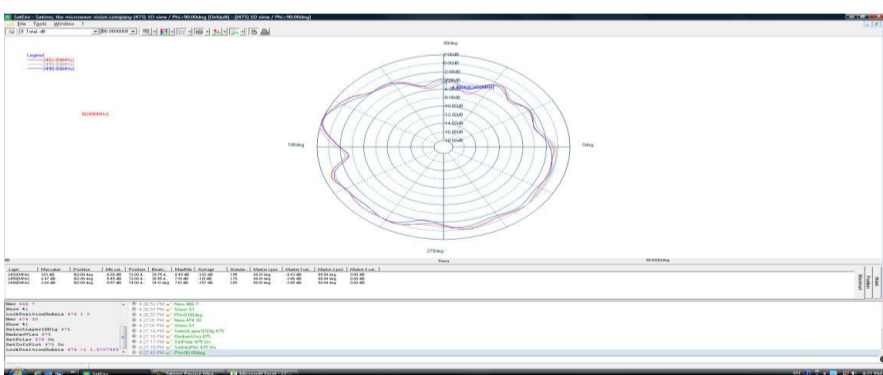

### 2.45G X-Y Plane

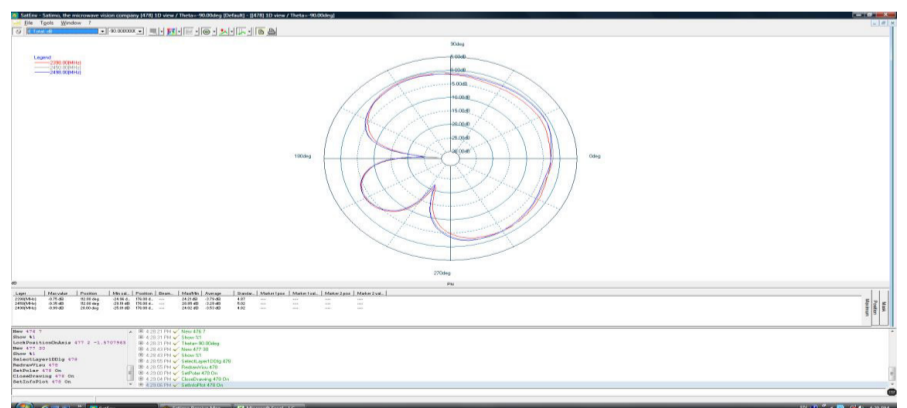

# WiFi + GPS Multiband Ceramic Chip Antenna

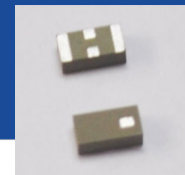

ACAG0301-15752450-T



3.2 x 1.6 x 1.2mm  
RoHS/RoHS II Compliant  
MSL = 1

## 3D PATTERNS

### GPS

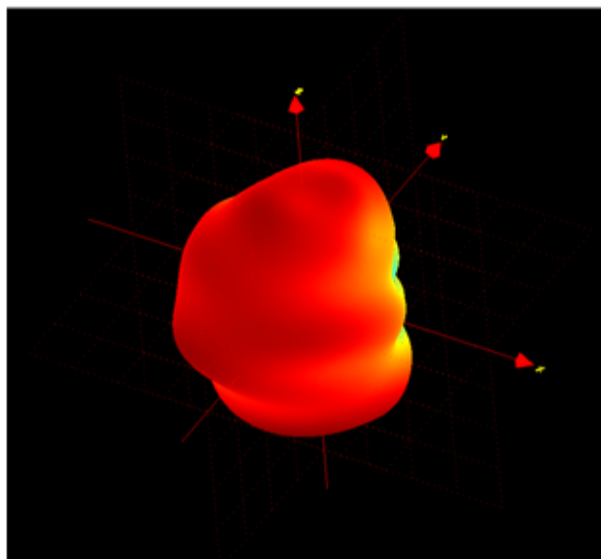

Frequency (MHz)	1565	1575	1585
Avg. Gain (dBi)	-1.5	-1.13	-1.65
Peak Gain (dBi)	1.05	1.21	1.13
Efficiency (%)	53	57	52

### 2.45 GHz

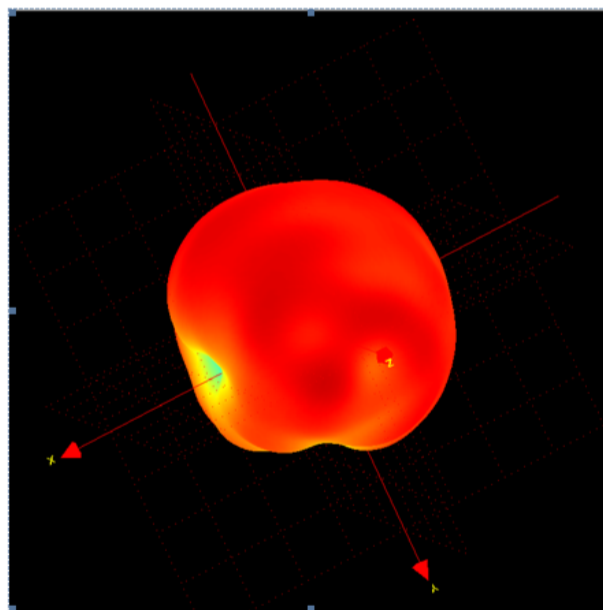

Frequency (MHz)	2400	2450	2500
Avg. Gain (dBi)	-1.42	-1.19	-1.57
Peak Gain (dBi)	2.87	3.18	2.96
Efficiency (%)	66	73	67

# WiFi + GPS Multiband Ceramic Chip Antenna

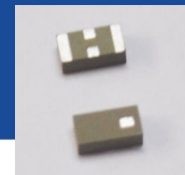

ACAG0301-15752450-T



3.2 x 1.6 x 1.2mm  
RoHS/RoHS II Compliant  
MSL = 1

## REFLOW SOLDERING STANDARD CONDITION

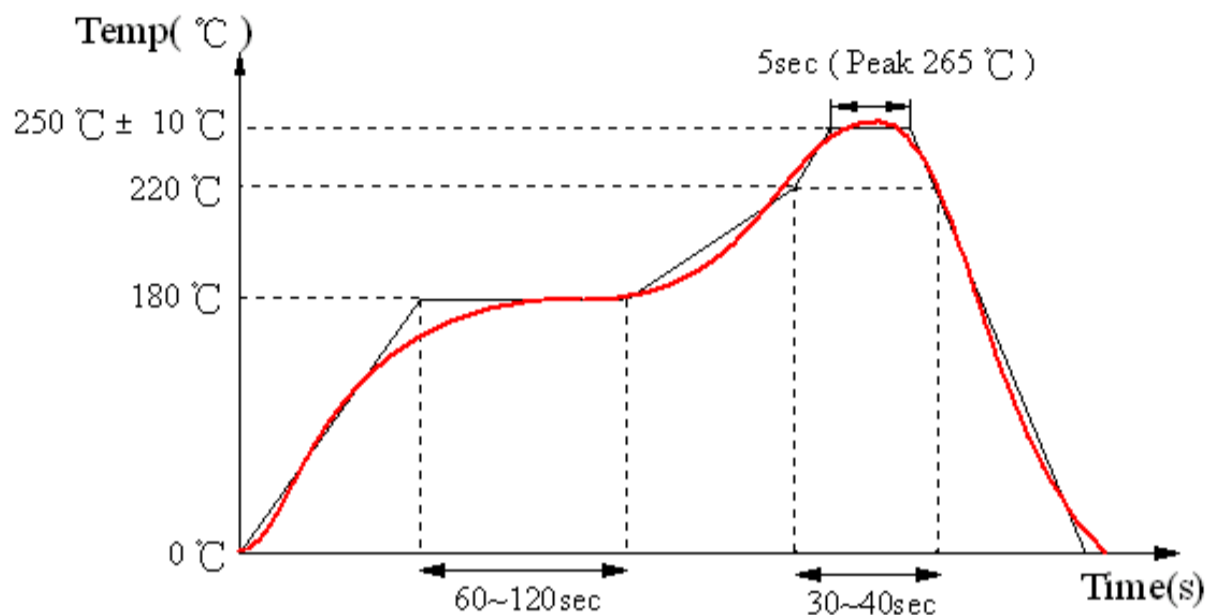

## PACKAGING

Reel (3000 pcs/Reel)

Size of the carton: 330 x 210 x 210 mm

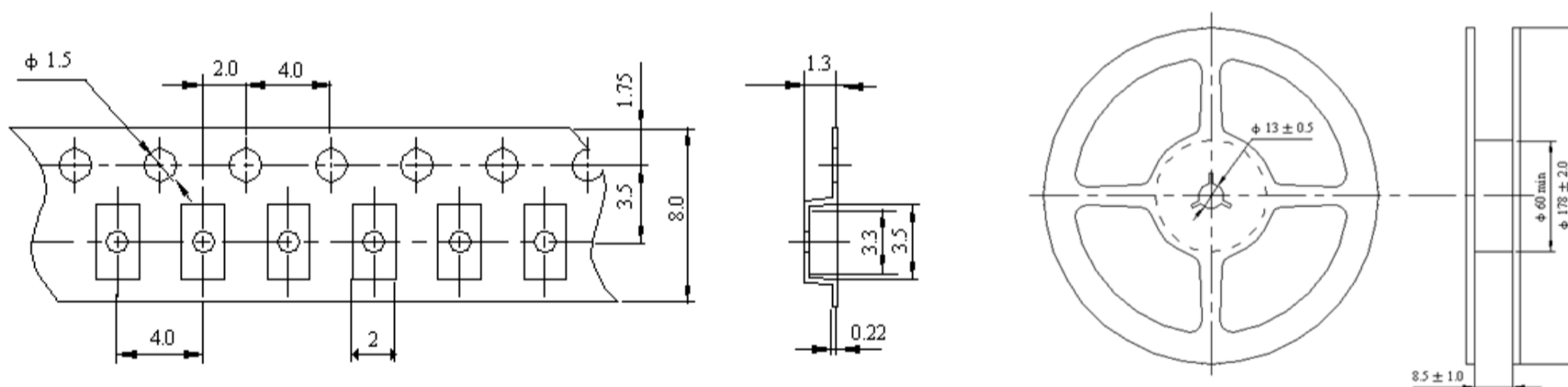

Dimensions: mm

Storage Temperature Range : <30 degree C, Humidity : <60%RH

MSL - 3

Oxidizable, 12 months in a vacuum sealed bag.

Once opened, please repack the unused items within 168 hours by re-seal package treatment.



5101 Hidden Creek Ln Spicewood TX 78669  
Phone: 512-371-6159 | Fax: 512-351-8858  
For terms and conditions of sales, please visit:  
[www.abracon.com](http://www.abracon.com)

REVISED: 04.02.2019

ABRACON IS  
ISO9001-2015  
CERTIFIED

# WiFi + GPS Multiband Ceramic Chip Antenna

ACAG0301-15752450-T

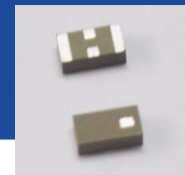

3.2 x 1.6 x 1.2mm  
RoHS/RoHS II Compliant  
MSL = 1

## CAUTIONS

---

### 1. Static voltage

Static voltage between signal & ground may cause deterioration & destruction of the component. Please avoid static voltage.

### 2. Ultrasonic cleaning

Ultrasonic vibration may cause deterioration & destruction of the component. Please avoid ultrasonic cleaning.

### 3. Soldering

Only leads of the component may be soldered. Please avoid soldering to any other part of the component, such as on the patterns as this will change the performance of the antenna.

## Данный компонент на территории Российской Федерации

### Вы можете приобрести в компании MosChip.

Для оперативного оформления запроса Вам необходимо перейти по данной ссылке:

<http://moschip.ru/get-element>

Вы можете разместить у нас заказ для любого Вашего проекта, будь то серийное производство или разработка единичного прибора.

В нашем ассортименте представлены ведущие мировые производители активных и пассивных электронных компонентов.

Нашей специализацией является поставка электронной компонентной базы двойного назначения, продукции таких производителей как XILINX, Intel (ex.ALTERA), Vicor, Microchip, Texas Instruments, Analog Devices, Mini-Circuits, Amphenol, Glenair.

Сотрудничество с глобальными дистрибьюторами электронных компонентов, предоставляет возможность заказывать и получать с международных складов практически любой перечень компонентов в оптимальные для Вас сроки.

На всех этапах разработки и производства наши партнеры могут получить квалифицированную поддержку опытных инженеров.

Система менеджмента качества компании отвечает требованиям в соответствии с ГОСТ Р ИСО 9001, ГОСТ РВ 0015-002 и ЭС РД 009

### Офис по работе с юридическими лицами:

105318, г.Москва, ул.Щербаковская д.3, офис 1107, 1118, ДЦ «Щербаковский»

Телефон: +7 495 668-12-70 (многоканальный)

Факс: +7 495 668-12-70 (доб.304)

E-mail: [info@moschip.ru](mailto:info@moschip.ru)

Skype отдела продаж:

moschip.ru

moschip.ru\_4

moschip.ru\_6

moschip.ru\_9