

Low Power 5V RS232 Dual Driver/Receiver with $\pm 15\text{kV}$ ESD Protection

FEATURES

- 10mA Max Supply Current
- ESD Protection to IEC 1000-4-2 Level 4
 $\pm 15\text{kV}$ Air Gap, $\pm 8\text{kV}$ Contact
- Uses Small Capacitors: $0.1\mu\text{F}$
- 120kbaud Operation for $R_L = 3\text{k}$, $C_L = 2500\text{pF}$
- 250kbaud Operation for $R_L = 3\text{k}$, $C_L = 1000\text{pF}$
- Outputs Withstand $\pm 30\text{V}$ Without Damage
- CMOS Comparable Low Power: 40mW
- Operates from a Single 5V Supply
- Rugged Bipolar Design
- Outputs Assume a High Impedance State When Off or Powered Down
- Meets All RS232 Specifications
- Available With or Without Shutdown
- Absolutely No Latch-up

APPLICATIONS

- Portable Computers
- Battery-Powered Systems
- Power Supply Generator
- Terminals
- Modems

DESCRIPTION

The LT[®]1780/LT1781 are dual RS232 driver/receiver pairs with integral charge pump to generate RS232 voltage levels from a single 5V supply. Using only $0.1\mu\text{F}$ external capacitors, these circuits consume only 40mW of power, and can operate to 120kbaud even while driving heavy capacitive loads. New ESD structures on the chip allow the LT1780/LT1781 to survive $\pm 15\text{kV}$ air gap and $\pm 8\text{kV}$ contact ESD tests per IEC 1000-4-2, eliminating the need for costly TransZorbs[®] on the RS232 line pins. The LT1780/LT1781 are fully compliant with EIA RS232 standards. Driver outputs are protected from overload, and can be shorted to ground or up to $\pm 30\text{V}$ without damage. During SHUTDOWN or power-off conditions, driver and receiver outputs are in a high impedance state, allowing line sharing.

The LT1780/LT1781 are direct upgrades to the LT1180A/LT1181A, LT1280A/LT1281A and LT1381 for applications which require the utmost ESD protection.

The LT1781 is available in 16-pin DIP, SO and SW packages. The LT1780 is supplied in 18-pin DIP and SW packages for applications which require SHUTDOWN.

LT, LTC and LT are registered trademarks of Linear Technology Corporation.
TransZorb is a registered trademark of General Instruments, GSI.

TYPICAL APPLICATION



Output Waveforms

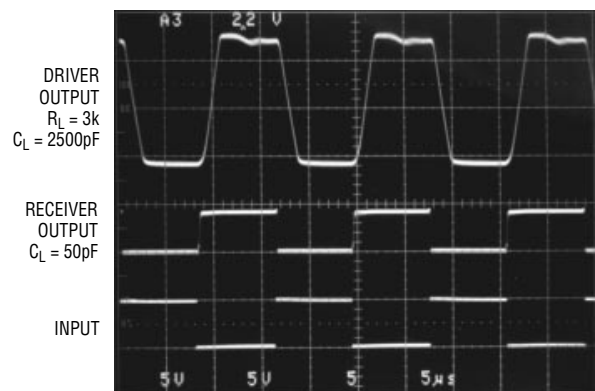

1780/81 • TA02

LT1780/LT1781

ABSOLUTE MAXIMUM RATINGS (Note 1)

Supply Voltage (V_{CC})	6V	Short-Circuit Duration	
V^+	13.2V	V^+	30 sec
V^-	-13.2V	V^-	30 sec
Input Voltage		Driver Output	Indefinite
Driver	V^- to V^+	Receiver Output	Indefinite
Receiver	-30V to 30V	Operating Temperature Range	0°C to 70°C
ON/OFF	-0.3V to 12V	Storage Temperature Range	-65°C to 150°C
Output Voltage		Lead Temperature (Soldering, 10 sec)	300°C
Driver	$V^+ - 30V$ to $V^- + 30V$		
Receiver	-0.3V to $V_{CC} + 0.3V$		

PACKAGE/ORDER INFORMATION

<p>TOP VIEW</p> <p>N PACKAGE 18-LEAD PLASTIC DIP</p> <p>SW PACKAGE 18-LEAD PLASTIC SO</p> <p>$T_{JMAX} = 125^{\circ}C$, $\theta_{JA} = 80^{\circ}C/W$, $\theta_{JC} = 36^{\circ}C/W$ (N) $T_{JMAX} = 125^{\circ}C$, $\theta_{JA} = 90^{\circ}C/W$, $\theta_{JC} = 26^{\circ}C/W$ (SW)</p>	<p>ORDER PART NUMBER</p> <p>LT1780CN LT1780CSW</p>	<p>TOP VIEW</p> <p>N PACKAGE 16-LEAD PLASTIC DIP</p> <p>S PACKAGE 16-LEAD PLASTIC SO</p> <p>SW PACKAGE 16-LEAD PLASTIC SO</p> <p>$T_{JMAX} = 125^{\circ}C$, $\theta_{JA} = 90^{\circ}C/W$, $\theta_{JC} = 46^{\circ}C/W$ (N) $T_{JMAX} = 125^{\circ}C$, $\theta_{JA} = 95^{\circ}C/W$, $\theta_{JC} = 34^{\circ}C/W$ (S) $T_{JMAX} = 125^{\circ}C$, $\theta_{JA} = 95^{\circ}C/W$, $\theta_{JC} = 27^{\circ}C/W$ (SW)</p>	<p>ORDER PART NUMBER</p> <p>LT1781CN LT1781CS LT1781CSW</p>
---	--	--	---

Consult factory for Industrial and Military grade parts.

ELECTRICAL CHARACTERISTICS (Note 2)

PARAMETER	CONDITIONS	MIN	TYP	MAX	UNITS
Power Supply Generator					
V^+ Output			7.9		V
V^- Output			-7		V
Supply Current (V_{CC})	(Note 3), $T_A = 25^{\circ}C$	●	8	10	mA
Supply Current When OFF (V_{CC})	SHUTDOWN (Note 4) LT1780 Only	●	1	10	μA
Supply Rise Time	$C1 = C2 = C3 = C4 = 0.1\mu F$		0.2		ms
SHUTDOWN to Turn-On	LT1780 Only		0.2		ms
ON/OFF Pin Thresholds	Input Low Level (Device SHUTDOWN)	●	0.8	1.2	V
	Input High Level (Device Enabled)	●	1.6	2.4	V
ON/OFF Pin Current	$0V \leq V_{ON/OFF} \leq 5V$	●	-15	80	μA
Oscillator Frequency			130		kHz
Driver					
Output Voltage Swing	Load = 3k to GND	Positive	5.0	7.5	V
		Negative	-6.3	-5	V
Logic Input Voltage Level	Input Low Level ($V_{OUT} = High$)	●	1.4	0.8	V
	Input High Level ($V_{OUT} = Low$)	●	2.0	1.4	V

ELECTRICAL CHARACTERISTICS (Note 2)

PARAMETER	CONDITIONS		MIN	TYP	MAX	UNITS
Logic Input Current	$0.8V \leq V_{IN} \leq 2.0V$	●		5	20	μA
Output Short-Circuit Current	$V_{OUT} = 0V$		± 7	17		mA
Output Leakage Current	SHUTDOWN $V_{OUT} = \pm 30V$ (Note 4)	●		10	100	μA
Data Rate	$R_L = 3k, C_L = 2500pF$ $R_L = 3k, C_L = 1000pF$		120 250			kBaud kBaud
Slew Rate	$R_L = 3k, C_L = 51pF$ $R_L = 3k, C_L = 2500pF$		4	15 7	30	$V/\mu s$ $V/\mu s$
Propagation Delay	Output Transition t_{HL} High-to-Low (Note 5) Output Transition t_{LH} Low-to-High			0.6 0.5	1.3 1.3	μs μs
Receiver						
Input Voltage Thresholds	Input Low Threshold ($V_{OUT} = \text{High}$) Input High Threshold ($V_{OUT} = \text{Low}$)		0.8	1.3 1.7	2.4	V V
Hysteresis		●	0.1	0.4	1	V
Input Resistance	$V_{IN} = \pm 10V$		3	5	7	$k\Omega$
Output Leakage Current	SHUTDOWN (Note 4) $0 \leq V_{OUT} \leq V_{CC}$	●		1	10	μA
Output Voltage	Output Low, $I_{OUT} = -1.6mA$ Output High, $I_{OUT} = 160\mu A$ ($V_{CC} = 5V$)	● ●	3.5	0.2 4.2	0.4	V V
Output Short-Circuit Current	Sinking Current, $V_{OUT} = V_{CC}$ Sourcing Current, $V_{OUT} = 0V$		10	-20 20	-10	mA mA
Propagation Delay	Output Transition t_{HL} High-to-Low (Note 6) Output Transition t_{LH} Low-to-High			250 350	600 600	ns ns

The ● denotes specifications which apply over the operating temperature range.

Note 1: Absolute Maximum Ratings are those values beyond which the life of the device may be impaired.

Note 2: Testing done at $V_{CC} = 5V$ and $V_{ON/OFF} = 3V$, unless otherwise specified.

Note 3: Supply current is measured as the average over several charge pump cycles. $C^+ = C^- = C1 = C2 = 0.1\mu F$. All outputs are open, with all driver inputs tied high.

Note 4: Supply current measurements in SHUTDOWN are performed with $V_{ON/OFF} \leq 0.1V$.

Note 5: For driver delay measurements, $R_L = 3k$ and $C_L = 51pF$. Trigger points are set between the driver's input logic threshold and the output transition to the zero crossing ($t_{HL} = 1.4V$ to $0V$ and $t_{LH} = 1.4V$ to $0V$).

Note 6: For receiver delay measurements, $C_L = 51pF$. Trigger points are set between the receiver's input logic threshold and the output transition to standard TTL/CMOS logic threshold ($t_{HL} = 1.3V$ to $2.4V$ and $t_{LH} = 1.7V$ to $0.8V$).

TYPICAL PERFORMANCE CHARACTERISTICS

Driver Maximum Output Voltage vs Load Capacitance

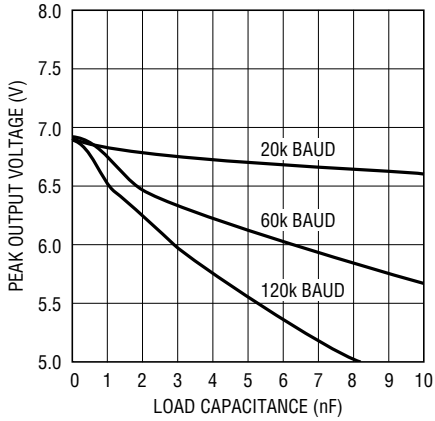

1780 • G01

Driver Minimum Output Voltage vs Load Capacitance

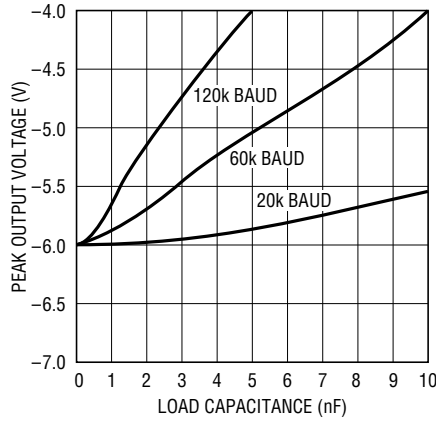

1780 • G02

Driver Output Voltage

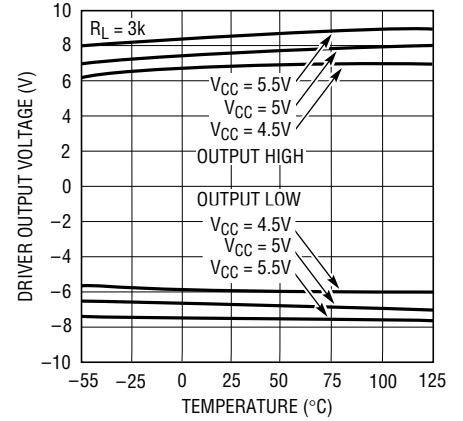

1780 • G03

Receiver Input Thresholds

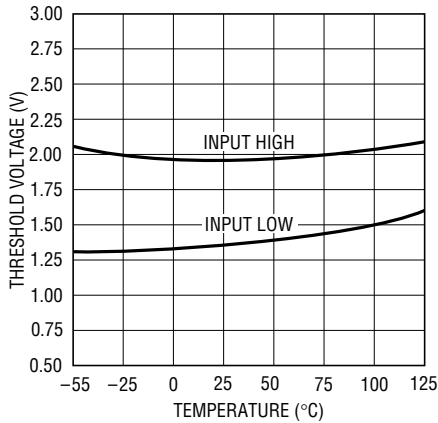

1780 • G04

Supply Current vs Data Rate

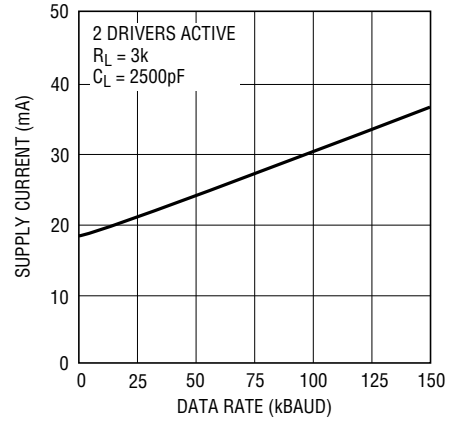

1780 • G05

ON/OFF Thresholds

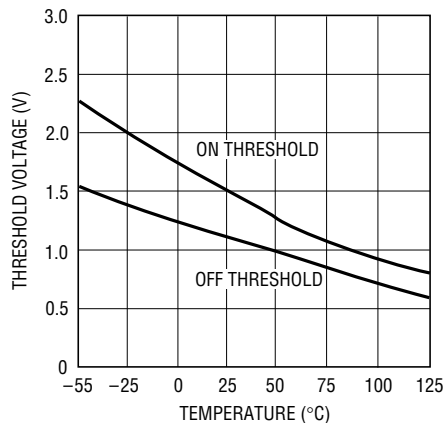

1780 • G06

Supply Current

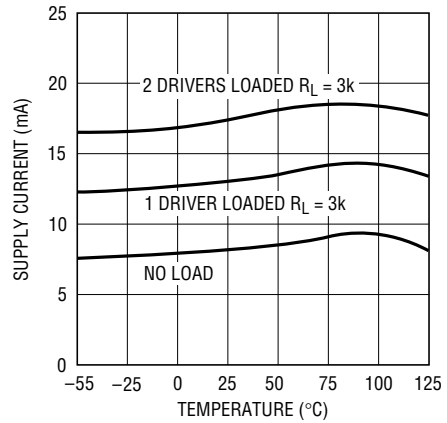

1780 • G07

TYPICAL PERFORMANCE CHARACTERISTICS

Driver Leakage in Shutdown



1780 • G08

Driver Short-Circuit Current



1780 • G09

Receiver Short-Circuit Current



1780 • G10

Slew Rate vs Load Capacitance



1780 • G11

Shutdown to Driver Outputs



1780 • G12

Driver Output Waveforms



1780 • G13

PIN FUNCTIONS

V_{CC}: 5V Input Supply Pin. This pin should be decoupled with a 0.1μF ceramic capacitor close to the package pin. Insufficient supply bypassing can result in low output drive levels and erratic charge pump operation.

GND: Ground Pin.

ON/OFF: A TTL/CMOS Compatible Operating Mode Control. A logic low puts the LT1780 in SHUTDOWN mode. Supply current drops to zero and both driver and receiver outputs assume a high impedance state. A logic high fully enables the device.

V⁺: Positive Supply Output (RS232 Drivers).

$V^+ \approx 2V_{CC} - 1.5V$. This pin requires an external charge storage capacitor $C \geq 0.1\mu F$, tied to ground or V_{CC} . Larger value capacitors may be used to reduce supply ripple. With multiple transceivers, the V^+ and V^- pins may be paralleled into common capacitors.

V⁻: Negative Supply Output (RS232 Drivers).

$V^- \approx -(2V_{CC} - 2.5V)$. This pin requires an external charge storage capacitor $C \geq 0.1\mu F$. Larger value capacitors may be used to reduce supply ripple. With multiple transceivers, the V^+ and V^- pins may be paralleled into common capacitors.

TR1 IN, TR2 IN: RS232 Driver Input Pins. These inputs are TTL/CMOS compatible. Inputs should not be allowed to float. Tie unused inputs to V_{CC} .

TR1 OUT, TR2 OUT: Driver Outputs at RS232 Voltage Levels. Driver output swing meets RS232 levels for loads up to 3k. Slew rates are controlled for lightly loaded lines. Output current capability is sufficient for load conditions up to 2500pF. Outputs are in a high impedance state when in SHUTDOWN mode or $V_{CC} = 0V$. Outputs are fully short-circuit protected from $V^- + 30V$ to $V^+ - 30V$. Applying higher voltages will not damage the device if the overdrive is moderately current limited. Short circuits on one output can load the power supply generator and may disrupt the signal levels of the other outputs. The driver outputs are protected against ESD to IEC-1000-4-2 Level 4 discharges.

REC1 IN, REC2 IN: Receiver Inputs. These pins accept RS232 level signals ($\pm 30V$) into a protected 5k terminating resistor. The receiver inputs are protected against ESD to IEC-1000-4-2 Level 4 discharges. Each receiver provides 0.4V of hysteresis for noise immunity. Open receiver inputs result in a logic high receiver output state.

REC1 OUT, REC2 OUT: Receiver outputs with TTL/CMOS Voltage Levels. Outputs are in a high impedance state when in SHUTDOWN mode to allow data line sharing. Outputs are fully short-circuit protected to ground or V_{CC} with the power ON, OFF or in the SHUTDOWN mode.

C1⁺, C1⁻, C2⁺, C2⁻: Commutating Capacitor Inputs. These pins require two external capacitors $C \geq 0.1\mu F$: one from $C1^+$ to $C1^-$ and another from $C2^+$ to $C2^-$. $C1$ should be deleted if a separate 12V supply is available and connected to pin $C1^+$. Similarly, $C2$ should be deleted if a separate $-12V$ supply is connected to pin V^- .

ESD PROTECTION

The RS232 line inputs of the LT1780/LT1781 have on-chip protection from ESD transients up to $\pm 15\text{kV}$ air gap and $\pm 8\text{kV}$ contact tested to IEC-1000-4-2 test methods. The protection structures act to divert the static discharge safely to system ground. In order for the ESD protection to function effectively, the power supply and ground pins of the circuit must be connected to ground through low impedances. The power supply decoupling capacitors and charge pump storage capacitors provide this low impedance in normal application of the circuit. The only constraint is that low ESR capacitors must be used for bypassing and charge storage. ESD testing must be done with pins V_{CC} , V_L , V^+ , V^- , and GND shorted to ground or connected with low ESR capacitors.



TYPICAL APPLICATION

Operation Using 5V and 12V Power Supplies



PACKAGE DESCRIPTION Dimensions in inches (millimeters) unless otherwise noted.

N Package
16-Lead PDIP (Narrow 0.300)
 (LTC DWG # 05-08-1510)



*THESE DIMENSIONS DO NOT INCLUDE MOLD FLASH OR PROTRUSIONS.
 MOLD FLASH OR PROTRUSIONS SHALL NOT EXCEED 0.010 INCH (0.254mm)

N16 1197

N Package
18-Lead PDIP (Narrow 0.300)
 (LTC DWG # 05-08-1510)

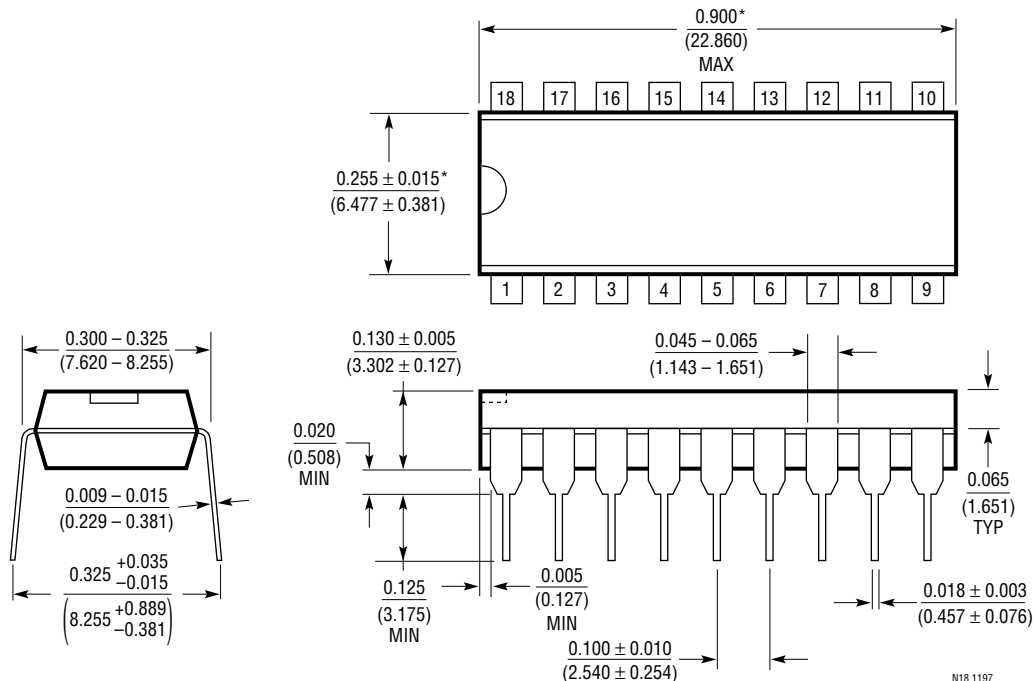

*THESE DIMENSIONS DO NOT INCLUDE MOLD FLASH OR PROTRUSIONS.
 MOLD FLASH OR PROTRUSIONS SHALL NOT EXCEED 0.010 INCH (0.254mm)

N18 1197

PACKAGE DESCRIPTION Dimensions in inches (millimeters) unless otherwise noted.

SW Package
16-Lead Plastic Small Outline (Wide 0.300)
 (LTC DWG # 05-08-1620)



NOTE:
 1. PIN 1 IDENT, NOTCH ON TOP AND CAVITIES ON THE BOTTOM OF PACKAGES ARE THE MANUFACTURING OPTIONS.
 THE PART MAY BE SUPPLIED WITH OR WITHOUT ANY OF THE OPTIONS

*DIMENSION DOES NOT INCLUDE MOLD FLASH. MOLD FLASH SHALL NOT EXCEED 0.006" (0.152mm) PER SIDE
 **DIMENSION DOES NOT INCLUDE INTERLEAD FLASH. INTERLEAD FLASH SHALL NOT EXCEED 0.010" (0.254mm) PER SIDE

S16 (WIDE) 0396

PACKAGE DESCRIPTION Dimensions in inches (millimeters) unless otherwise noted.

SW Package
18-Lead Plastic Small Outline (Wide 0.300)
 (LTC DWG # 05-08-1620)



NOTE:
 1. PIN 1 IDENT, NOTCH ON TOP AND CAVITIES ON THE BOTTOM OF PACKAGES ARE THE MANUFACTURING OPTIONS.
 THE PART MAY BE SUPPLIED WITH OR WITHOUT ANY OF THE OPTIONS

*DIMENSION DOES NOT INCLUDE MOLD FLASH. MOLD FLASH SHALL NOT EXCEED 0.006" (0.152mm) PER SIDE
 **DIMENSION DOES NOT INCLUDE INTERLEAD FLASH. INTERLEAD FLASH SHALL NOT EXCEED 0.010" (0.254mm) PER SIDE

S18 (WIDE) 0396

PACKAGE DESCRIPTION Dimensions in inches (millimeters) unless otherwise noted.

S Package
16-Lead Plastic Small Outline (Narrow 0.150)
 (LTC DWG # 05-08-1610)



*DIMENSION DOES NOT INCLUDE MOLD FLASH. MOLD FLASH SHALL NOT EXCEED 0.006" (0.152mm) PER SIDE
 **DIMENSION DOES NOT INCLUDE INTERLEAD FLASH. INTERLEAD FLASH SHALL NOT EXCEED 0.010" (0.254mm) PER SIDE

S16 0695

TYPICAL APPLICATION

Supporting an LT1039 (Triple Driver/Receiver)



RELATED PARTS

PART NUMBER	DESCRIPTION	COMMENTS
LT1137A	3Driver/5Receiver RS232 Transceiver	IEC-1000-4-2 Level 4 ESD Compliance
LTC1383	5V Low Power RS232 2Driver/2Receiver Transceiver	Low Supply Current $I_{CC} = 220\mu A$
LTC1387	Single 5V RS232/RS485 Multiprotocol Transceiver	Configurable as Dual RS232 or Single RS485 Transceiver

Данный компонент на территории Российской Федерации

Вы можете приобрести в компании MosChip.

Для оперативного оформления запроса Вам необходимо перейти по данной ссылке:

<http://moschip.ru/get-element>

Вы можете разместить у нас заказ для любого Вашего проекта, будь то серийное производство или разработка единичного прибора.

В нашем ассортименте представлены ведущие мировые производители активных и пассивных электронных компонентов.

Нашей специализацией является поставка электронной компонентной базы двойного назначения, продукции таких производителей как XILINX, Intel (ex.ALTERA), Vicor, Microchip, Texas Instruments, Analog Devices, Mini-Circuits, Amphenol, Glenair.

Сотрудничество с глобальными дистрибьюторами электронных компонентов, предоставляет возможность заказывать и получать с международных складов практически любой перечень компонентов в оптимальные для Вас сроки.

На всех этапах разработки и производства наши партнеры могут получить квалифицированную поддержку опытных инженеров.

Система менеджмента качества компании отвечает требованиям в соответствии с ГОСТ Р ИСО 9001, ГОСТ РВ 0015-002 и ЭС РД 009

Офис по работе с юридическими лицами:

105318, г.Москва, ул.Щербаковская д.3, офис 1107, 1118, ДЦ «Щербаковский»

Телефон: +7 495 668-12-70 (многоканальный)

Факс: +7 495 668-12-70 (доб.304)

E-mail: info@moschip.ru

Skype отдела продаж:

moschip.ru

moschip.ru_4

moschip.ru_6

moschip.ru_9