

Features

- Gain: 16 dB
- Flatness: ± 2 dB
- 50 Ω match in and out
- P1dB: +18 dBm @ 14 GHz
- Single DC supply, +5 V to +12 V, 45 mA
- Lead-Free 1.5 x 1.2 mm 6-Lead TDFN package
- Halogen-Free “Green” Mold Compound
- RoHS* Compliant and 260°C Reflow Compatible

Description

The MAAM-011101 operates from 4 to 20 GHz and features 16 dB typical gain and +18 dBm of output power. The input and output are fully matched to 50 Ω with a typical return loss better than 12 dB. Small signal linearity is typically +30 dBm and reverse isolation better than 28 dB. This device requires a minimum of +5V, typically +8V, and maximum +10V for standard operation. Typical current is 45 mA.

Typical usage is a system buffer amplifier, gain block, mixer LO driver, power amplifier driver requiring small size and high performance. Typical applications are for WiFi, WiMAX, Point-to-Point radios, IMS, EW, and Aerospace and Defense.

The MAAM-011101 is housed in a leadless 1.5 x 1.2 mm package that is small yet can be handled and placed with standard pick and place assembly equipment. It is fabricated using a GaAs process which features full passivation for increased performance and reliability.

Functional Schematic

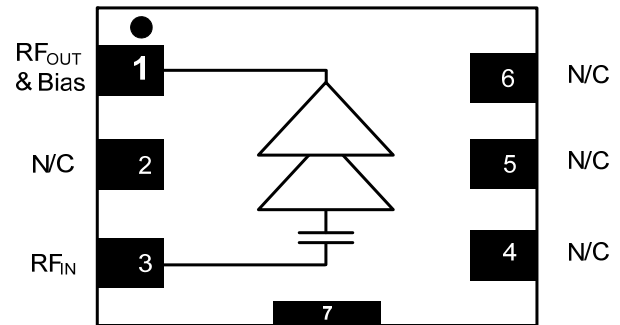

Pin Configuration

| Pin No. | Pin Name | Description |
|----------------|-------------------|-----------------------|
| 1 | RF _{OUT} | RF Output & Bias (Vd) |
| 2 | N/C | No Connection |
| 3 | RF _{IN} | RF Input |
| 4 | N/C | No Connection |
| 5 | N/C | No Connection |
| 6 | N/C | No Connection |
| 7 ¹ | Paddle | GND |

1. The exposed pad centered on the package bottom must be connected to RF and DC ground.

Ordering Information ^{2,3}

| Part Number | Package |
|--------------------|-------------------|
| MAAM-011101-TR1000 | 1000 Piece Reel |
| MAAM-011101-001SMB | Sample Test Board |

2. Reference Application Note M513 for reel size information.
3. All sample boards include 5 loose parts.

* Restrictions on Hazardous Substances, European Union Directive 2002/95/EC.

Electrical Specifications: $T_A = +25^\circ\text{C}$, $V_D = +8$ Volts, $Z_0 = 50 \Omega$

| Parameter | Test Conditions | Units | Min. | Typ. | Max. |
|--------------------|-----------------|-------|------|------|------|
| Gain | 4 GHz | dB | — | 13 | — |
| | 8 GHz | | 17 | | |
| | 12 GHz | | — | 16 | |
| | 16 GHz | | — | 15 | |
| | 20 GHz | | — | 15 | |
| Noise Figure | 4 - 20 GHz | dB | — | 4 | — |
| Input Return Loss | 6 - 18 GHz | dB | — | 12 | — |
| Output Return Loss | 6 - 18 GHz | dB | — | 14 | — |
| Isolation | 4 - 20 GHz | dB | — | 30 | — |
| P1dB | 4 GHz | dBm | — | +15 | — |
| | 8 GHz | | +16 | +17 | |
| | 12 GHz | | — | +19 | |
| | 16 GHz | | — | +19 | |
| | 20 GHz | | — | +18 | |
| I_{DD} | +8 Volts | mA | 35 | 45 | 55 |

Absolute Maximum Ratings ^{4,5,6}

| Parameter | Absolute Maximum |
|-----------------------------------|------------------|
| RF Input Power | +23 dBm |
| Voltage | +12 volts |
| Operating Temperature | -40°C to +85°C |
| Junction Temperature ⁷ | +150°C |
| Storage Temperature | -65°C to +150°C |

4. Exceeding any one or combination of these limits may cause permanent damage to this device.
5. M/A-COM Technology Solutions does not recommend sustained operation near these survivability limits.
6. Operating at nominal conditions with $T_J \leq +150^\circ\text{C}$ will ensure $MTTF > 1 \times 10^6$ hours.
7. Junction Temperature (T_J) = $T_C + \Theta_{JC} * ((V * I) - (P_{OUT} - P_{IN}))$
Typical thermal resistance (Θ_{JC}) = 40°C/W
 - a) For $T_C = 25^\circ\text{C}$,
 $T_J = +43^\circ\text{C}$ @ +10 V, 45 mA, $P_{OUT} = -4$ dBm, $P_{IN} = -20$ dBm
 - b) For $T_C = 85^\circ\text{C}$,
 $T_J = +103^\circ\text{C}$ @ +10 V, 45 mA, $P_{OUT} = -3$ dBm, $P_{IN} = -20$ dBm

Handling Procedures

Please observe the following precautions to avoid damage:

Static Sensitivity

Gallium Arsenide Integrated Circuits are sensitive to electrostatic discharge (ESD) and can be damaged by static electricity. Proper ESD control techniques should be used when handling these Class 0 devices.

Recommended PCB

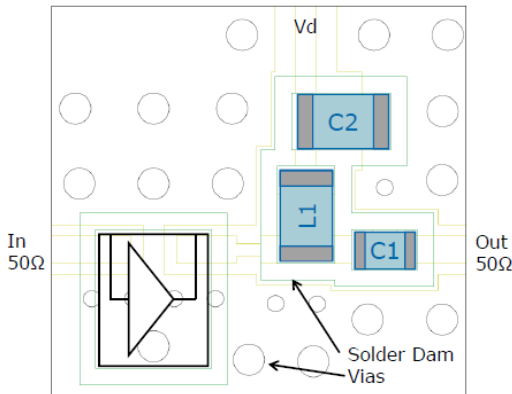

Application Schematic

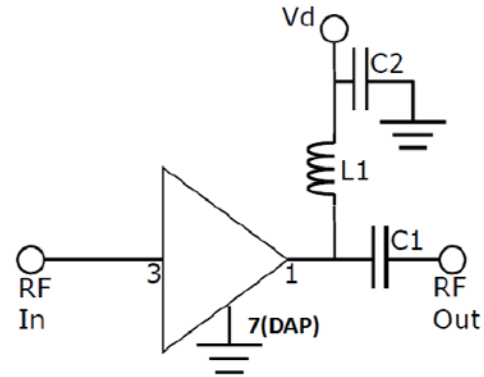

Parts List

| Comp. | Value | Pkg. | Manf. | Purpose |
|-------|--------|------|-------------------------|----------|
| C1 | 100 pF | 0201 | Murata GRM0335C1E101 | DC Block |
| C2 | 100 pF | 0402 | Murata GRM1555C1E101 | Bypass |
| L1 | 470 Ω | 0402 | Murata BLM15GG471 | Choke |

Evaluation Board

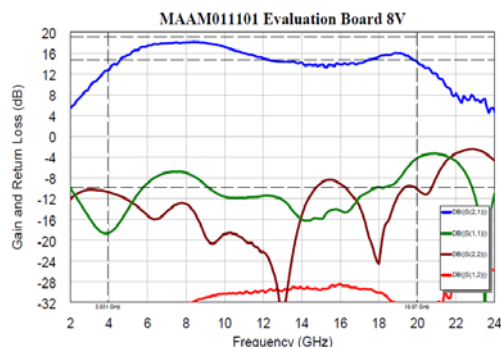
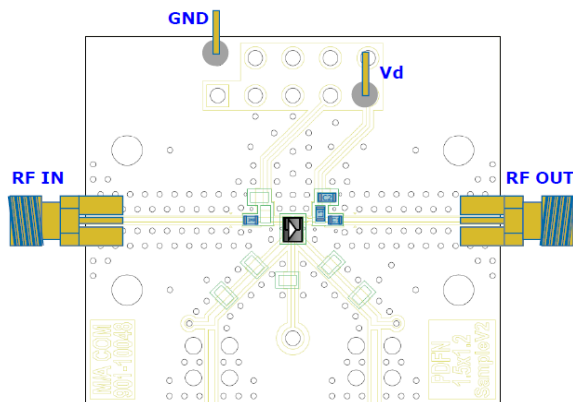

Application Information

The MAAM-011101 is designed to be easy to use yet high performance. The ultra small size, no matching, and simple bias allows easy placement on any system board.

LO Buffer applications:

The MAAM-011101 is good as a LO buffer since it has excellent isolation, selectable power output, low phase noise, and 50 Ω match (even under heavy drive). It is designed to deliver saturated output levels up to +20 dBm common to driving mixer configurations. It is typically used in conjunction with filters or splitters after the VCO or PLL.

PA Driver applications:

The MAAM-011101 makes a very good low cost driver before the transmit power amplifier. Set typically 7 dB backed off P1dB as a linear driver, it still delivers up to +12 dBm. Often cascaded in series with an attenuator, it allows gain control with little pulling due to mis-match. The low gain expansion allows little AM-to-AM distortion.

Grounding:

It is recommended that the total ground (common mode) inductance not exceed 0.03 nH (30 pH). This is equivalent to at least four 8 mil (200 u) vias per 8 mil board (200 u) be place under the device to ground

DC Bias Tee:

To bias properly, a DC voltage must be applied at the output pin. Typically this is down with a 2 element bias network that consists of a choke and a DC blocking capacitor. We recommend a high Q inductor for the choke and quality capacitor for the DC block.

Typical Performance Curves over temperature, $V_D = +8\text{ V}$, $Z_0 = 50\ \Omega$

Gain

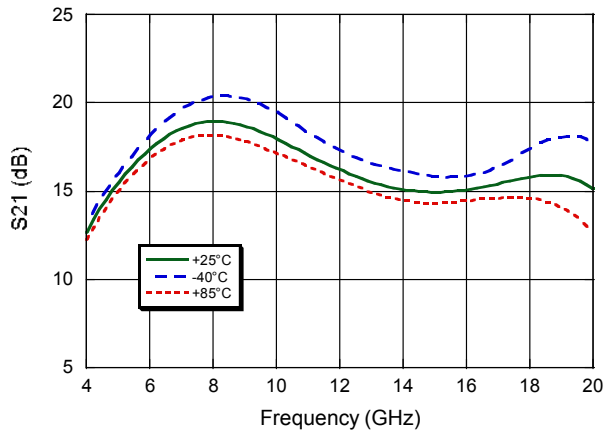

Noise Figure

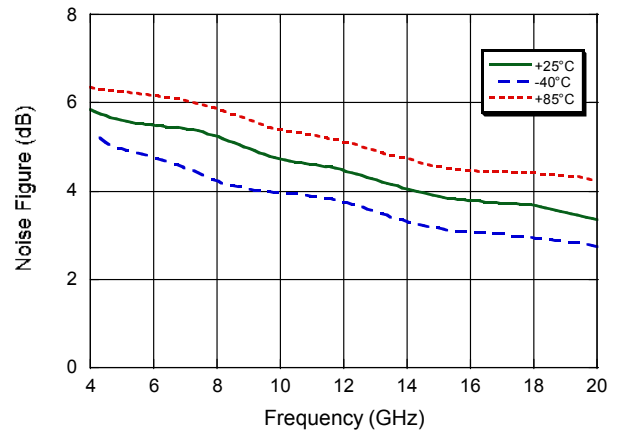

Input Return Loss

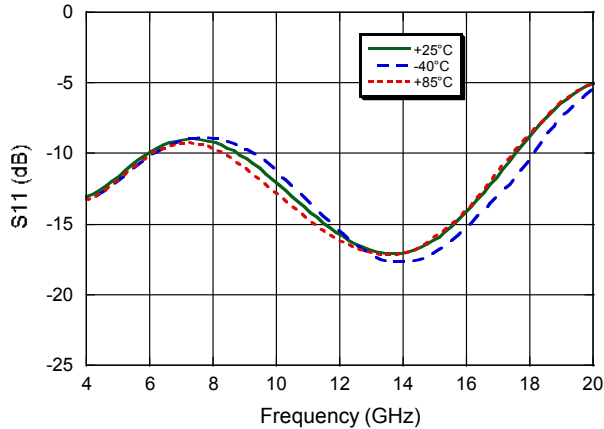

Output Return Loss

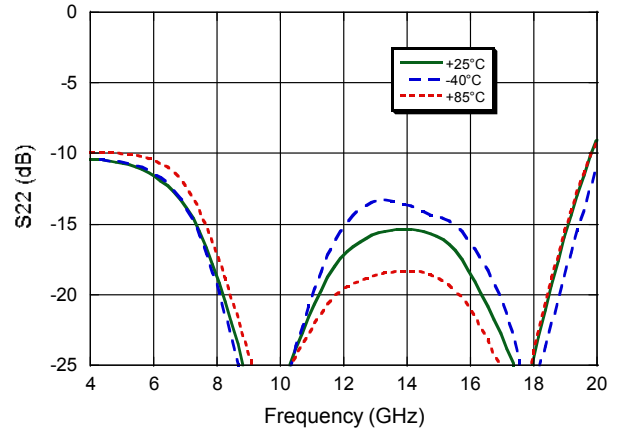

Output P1dB

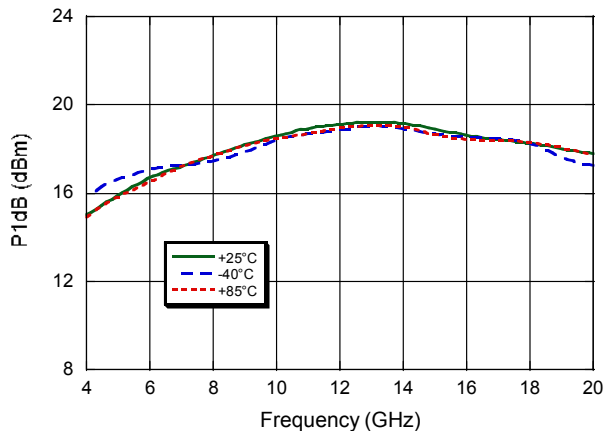

Output IP3

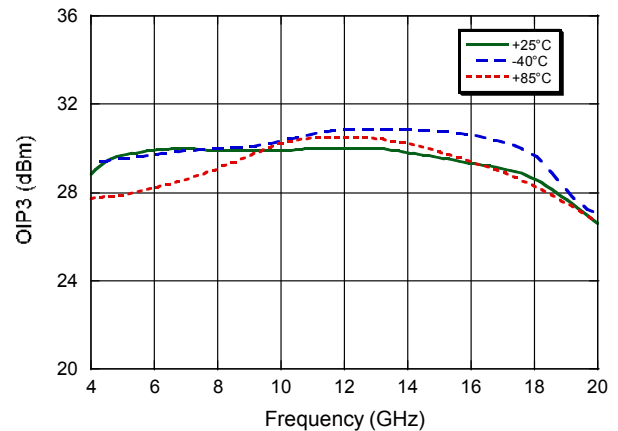

Typical Performance Curves over supply voltage, $T_A = +25^\circ\text{C}$, $Z_0 = 50 \Omega$

Gain

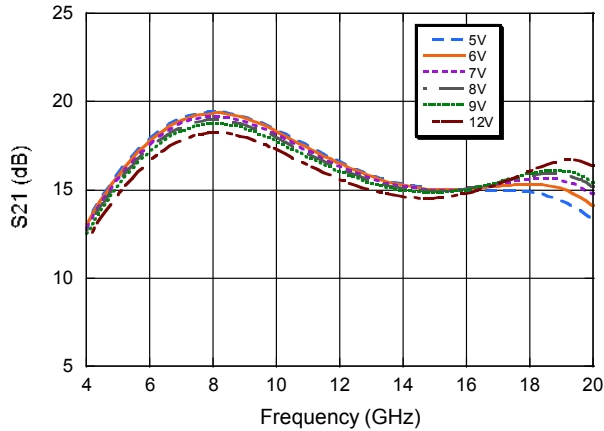

Noise Figure

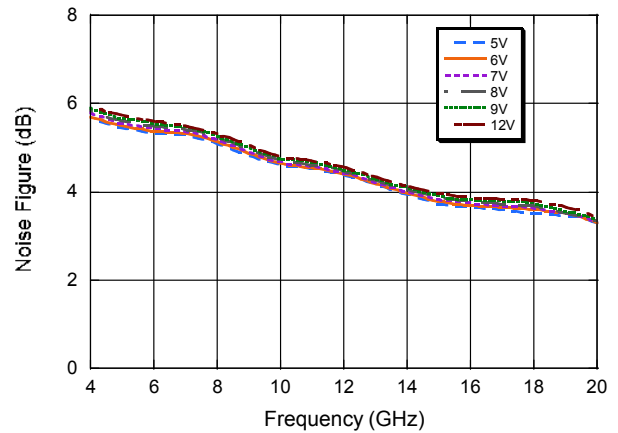

Input Return Loss

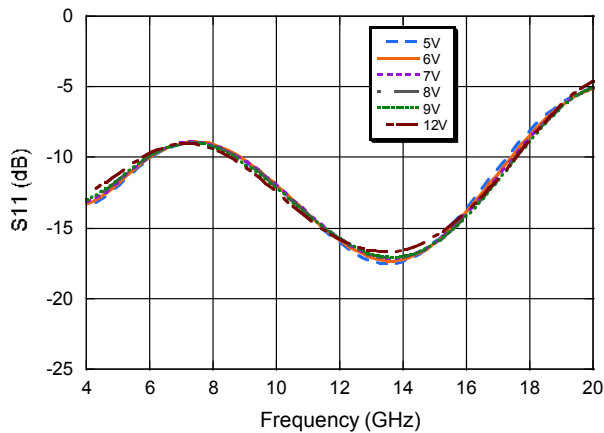

Output Return Loss

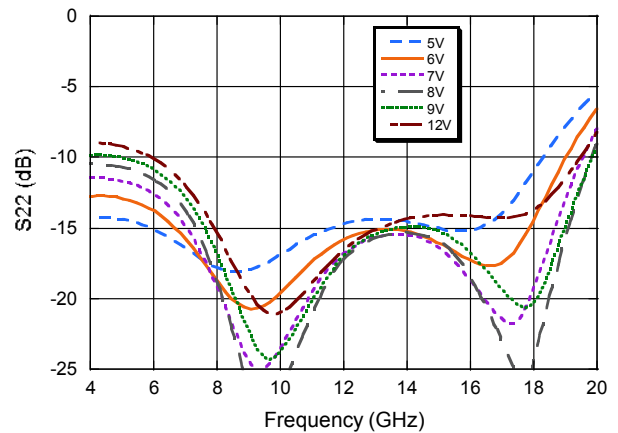

Output P1dB

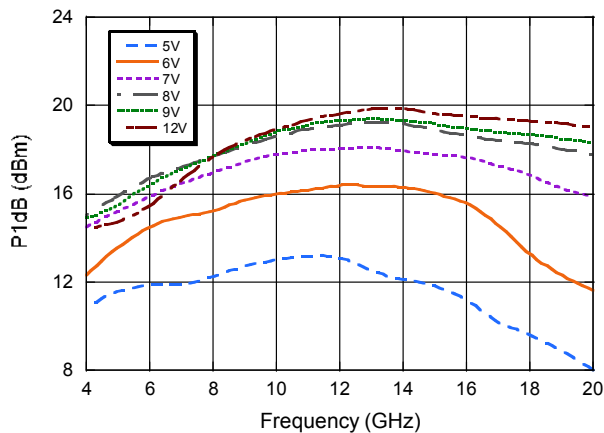

Output IP3

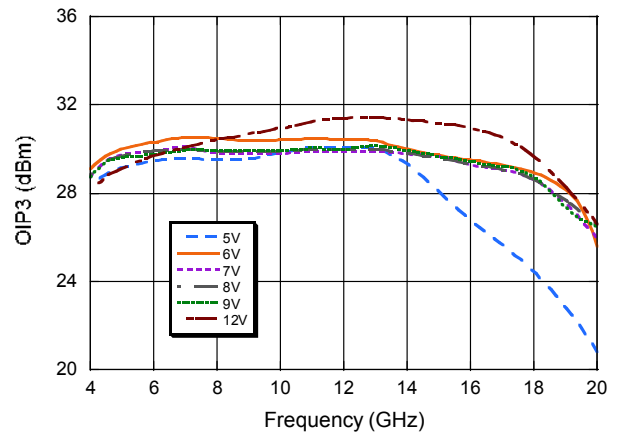

Typical Performance Curves

Isolation over voltage

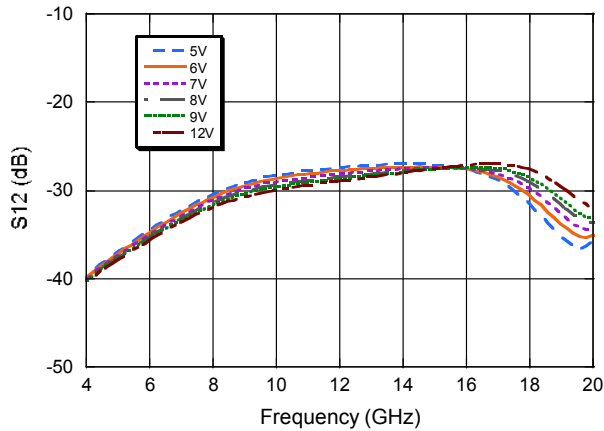

Isolation over temperature

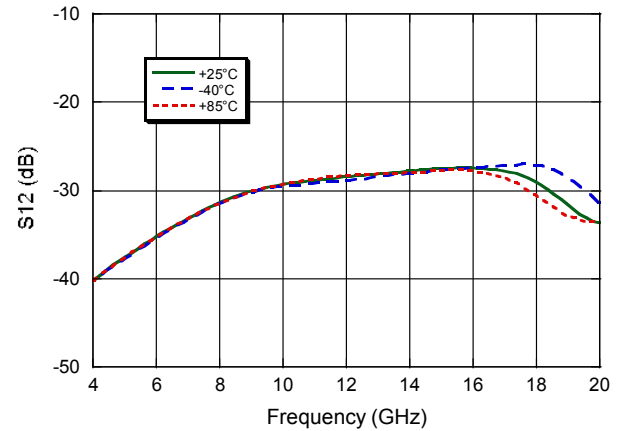

Current vs. Voltage over temperature

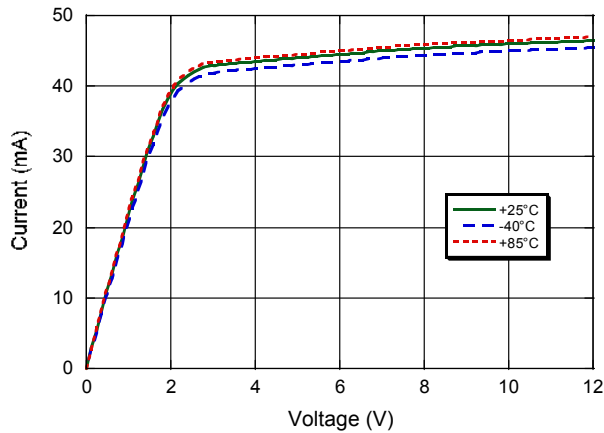

Gain vs. Voltage over temperature @ 12 GHz

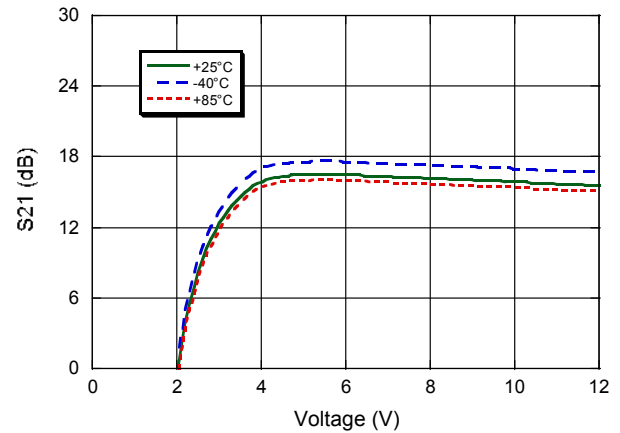

Output P1dB @ 12 GHz

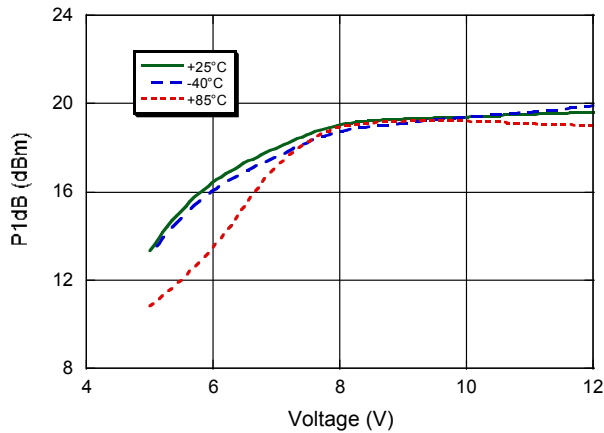

Output IP3 @ 12 GHz

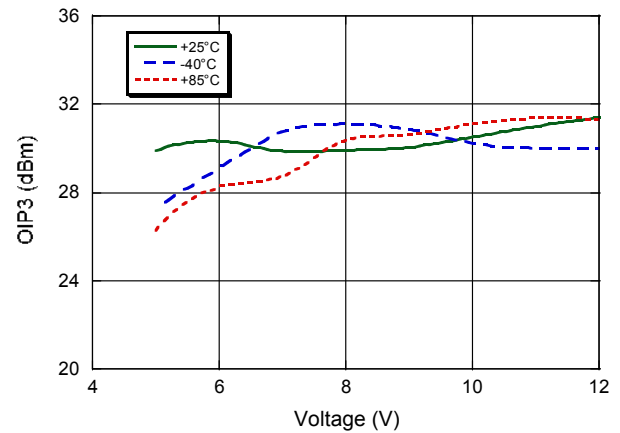

Lead-Free 1.5 x 1.2 mm 6-Lead TDFN[†]

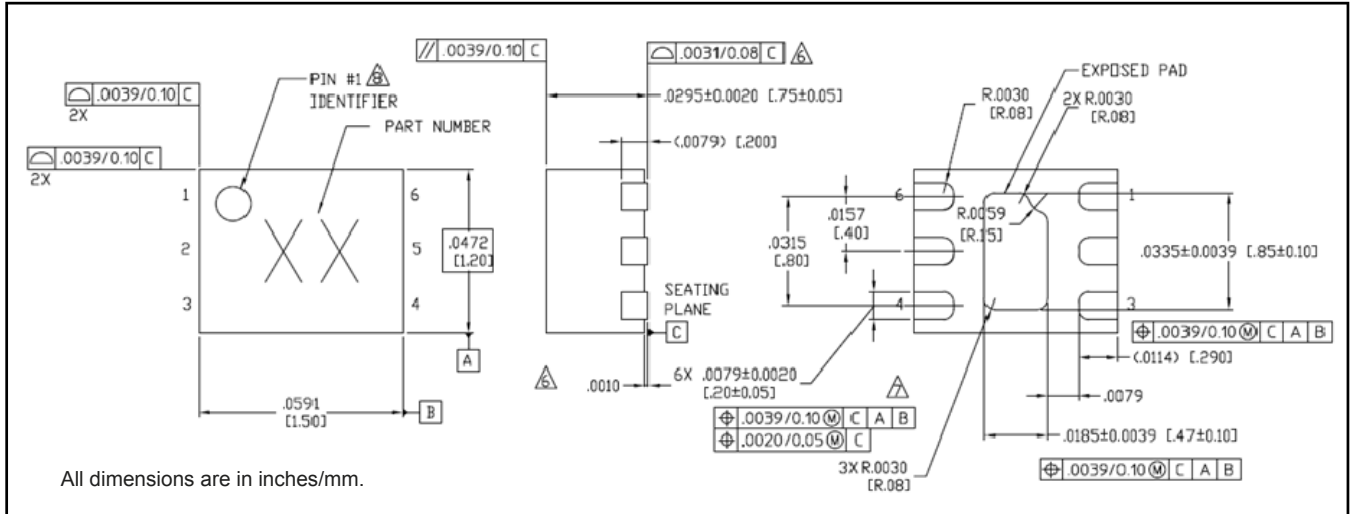

[†] Reference Application Note M538 for lead-free solder reflow recommendations.
Meets JEDEC moisture sensitivity level 1 requirements.
Plating is 100% matte tin over copper.

Данный компонент на территории Российской Федерации

Вы можете приобрести в компании MosChip.

Для оперативного оформления запроса Вам необходимо перейти по данной ссылке:

<http://moschip.ru/get-element>

Вы можете разместить у нас заказ для любого Вашего проекта, будь то серийное производство или разработка единичного прибора.

В нашем ассортименте представлены ведущие мировые производители активных и пассивных электронных компонентов.

Нашей специализацией является поставка электронной компонентной базы двойного назначения, продукции таких производителей как XILINX, Intel (ex.ALTERA), Vicor, Microchip, Texas Instruments, Analog Devices, Mini-Circuits, Amphenol, Glenair.

Сотрудничество с глобальными дистрибьюторами электронных компонентов, предоставляет возможность заказывать и получать с международных складов практически любой перечень компонентов в оптимальные для Вас сроки.

На всех этапах разработки и производства наши партнеры могут получить квалифицированную поддержку опытных инженеров.

Система менеджмента качества компании отвечает требованиям в соответствии с ГОСТ Р ИСО 9001, ГОСТ РВ 0015-002 и ЭС РД 009

Офис по работе с юридическими лицами:

105318, г.Москва, ул.Щербаковская д.3, офис 1107, 1118, ДЦ «Щербаковский»

Телефон: +7 495 668-12-70 (многоканальный)

Факс: +7 495 668-12-70 (доб.304)

E-mail: info@moschip.ru

Skype отдела продаж:

moschip.ru

moschip.ru_4

moschip.ru_6

moschip.ru_9