



Is Now Part of



**ON Semiconductor®**

To learn more about ON Semiconductor, please visit our website at  
[www.onsemi.com](http://www.onsemi.com)

Please note: As part of the Fairchild Semiconductor integration, some of the Fairchild orderable part numbers will need to change in order to meet ON Semiconductor's system requirements. Since the ON Semiconductor product management systems do not have the ability to manage part nomenclature that utilizes an underscore (\_), the underscore (\_) in the Fairchild part numbers will be changed to a dash (-). This document may contain device numbers with an underscore (\_). Please check the ON Semiconductor website to verify the updated device numbers. The most current and up-to-date ordering information can be found at [www.onsemi.com](http://www.onsemi.com). Please email any questions regarding the system integration to [Fairchild\\_questions@onsemi.com](mailto:Fairchild_questions@onsemi.com).

ON Semiconductor and the ON Semiconductor logo are trademarks of Semiconductor Components Industries, LLC dba ON Semiconductor or its subsidiaries in the United States and/or other countries. ON Semiconductor owns the rights to a number of patents, trademarks, copyrights, trade secrets, and other intellectual property. A listing of ON Semiconductor's product/patent coverage may be accessed at [www.onsemi.com/site/pdf/Patent-Marking.pdf](http://www.onsemi.com/site/pdf/Patent-Marking.pdf). ON Semiconductor reserves the right to make changes without further notice to any products herein. ON Semiconductor makes no warranty, representation or guarantee regarding the suitability of its products for any particular purpose, nor does ON Semiconductor assume any liability arising out of the application or use of any product or circuit, and specifically disclaims any and all liability, including without limitation special, consequential or incidental damages. Buyer is responsible for its products and applications using ON Semiconductor products, including compliance with all laws, regulations and safety requirements or standards, regardless of any support or applications information provided by ON Semiconductor. "Typical" parameters which may be provided in ON Semiconductor data sheets and/or specifications can and do vary in different applications and actual performance may vary over time. All operating parameters, including "Typicals" must be validated for each customer application by customer's technical experts. ON Semiconductor does not convey any license under its patent rights nor the rights of others. ON Semiconductor products are not designed, intended, or authorized for use as a critical component in life support systems or any FDA Class 3 medical devices or medical devices with a same or similar classification in a foreign jurisdiction or any devices intended for implantation in the human body. Should Buyer purchase or use ON Semiconductor products for any such unintended or unauthorized application, Buyer shall indemnify and hold ON Semiconductor and its officers, employees, subsidiaries, affiliates, and distributors harmless against all claims, costs, damages, and expenses, and reasonable attorney fees arising out of, directly or indirectly, any claim of personal injury or death associated with such unintended or unauthorized use, even if such claim alleges that ON Semiconductor was negligent regarding the design or manufacture of the part. ON Semiconductor is an Equal Opportunity/Affirmative Action Employer. This literature is subject to all applicable copyright laws and is not for resale in any manner.



September 2015

# FAN7530 Critical Conduction Mode PFC Controller

## Features

- Low Total Harmonic Distortion (THD)
- Precise Adjustable Output Over-Voltage Protection
- Open-Feedback Protection and Disable Function
- Zero Current Detector
- 150µs Internal Start-up Timer
- MOSFET Over-Current Protection
- Under-Voltage Lockout with 3.5V Hysteresis
- Low Start-up (40µA) and Operating Current (1.5mA)
- Totem Pole Output with High State Clamp
- +500/-800mA Peak Gate Drive Current
- 8-pin DIP or 8-pin SOP

## Applications

- Adapter
- Ballast
- LCD TV, CRT TV
- SMPS

## Related Application Notes

- **AN-6027** - Design of Power Factor Correction Circuit Using FAN7530

## Description

The FAN7530 is an active power factor correction (PFC) controller for the boost PFC applications that operates in critical conduction mode (CRM). It uses the voltage mode PWM that compares an internal ramp signal with the error amplifier output to generate MOSFET turn-off signal. Because the voltage mode CRM PFC controller does not need the rectified AC line voltage information, it can save the power loss of the input voltage sensing network necessary for the current mode CRM PFC controller.

FAN7530 provides many protection functions such as over voltage protection, open-feedback protection, over-current protection, and under-voltage lockout protection. The FAN7530 can be disabled if the INV pin voltage is lower than 0.45V and the operating current decreases to 65µA. Using a new variable on-time control method, THD is lower than the conventional CRM boost PFC ICs.

## Ordering Information

Part Number	Operating Temp. Range	Pb-Free	Package	Packing Method	Marking Code
FAN7530N	-40°C to +125°C	Yes	8-DIP	Rail	FAN7530
FAN7530M	-40°C to +125°C	Yes	8-SOP	Rail	FAN7530
FAN7530MX	-40°C to +125°C	Yes	8-SOP	Tape & Reel	FAN7530

### Typical Application Diagrams

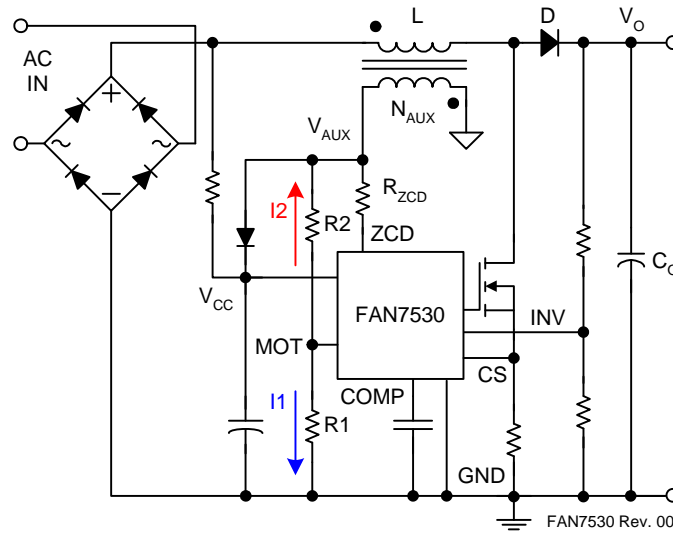


Figure 1. Typical Boost PFC Application

### Internal Block Diagram

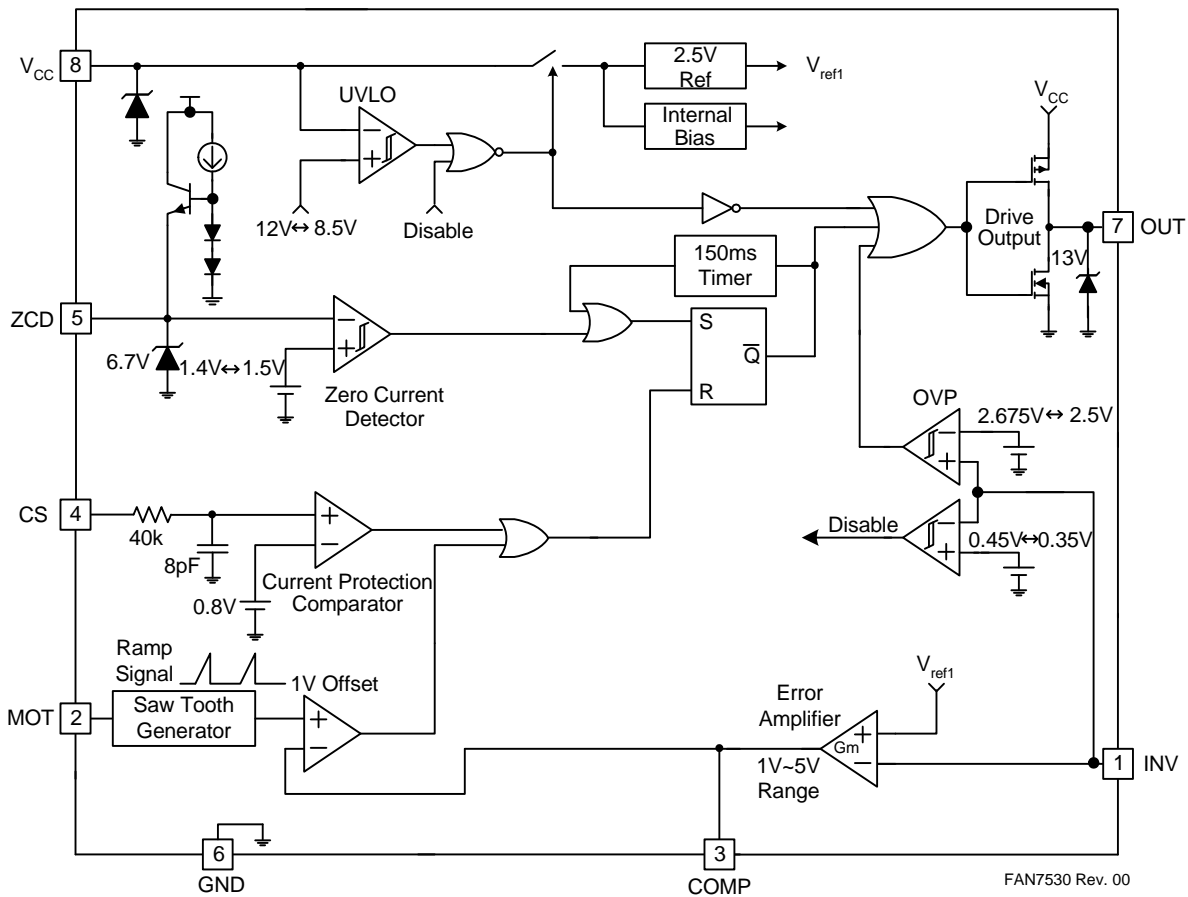
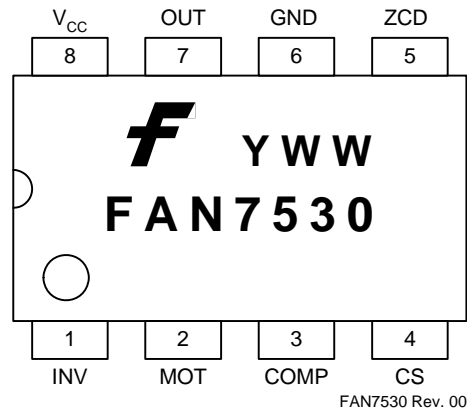


Figure 2. Functional Block Diagram of FAN7530

## Pin Assignments



**Figure 3. Pin Configuration (Top View)**

## Pin Definitions

Pin #	Name	Description
1	INV	This pin is the inverting input of the error amplifier. The output voltage of the boost PFC converter should be resistively divided to 2.5V.
2	MOT	This pin is used to set the slope of the internal ramp. The voltage of this pin is maintained at 3V. If a resistor is connected between this pin and GND, current flows out of the pin and the slope of the internal ramp is proportional to this current.
3	COMP	This pin is the output of the transconductance error amplifier. Components for the output voltage compensation should be connected between this pin and GND.
4	CS	This pin is the input of the over-current protection comparator. The MOSFET current is sensed using a sensing resistor and the resulting voltage is applied to this pin. An internal RC filter is included to filter switching noise.
5	ZCD	This pin is the input of the zero current detection block. If the voltage of this pin goes higher than 1.5V, then goes lower than 1.4V, the MOSFET is turned on.
6	GND	This pin is used for the ground potential of all the pins. For proper operation, the signal ground and the power ground should be separated.
7	OUT	This pin is the gate drive output. The peak sourcing and sinking current levels are +500mA and -800mA respectively. For proper operation, the stray inductance in the gate driving path must be minimized.
8	V <sub>CC</sub>	This pin is the IC supply pin. IC current and MOSFET drive current are supplied using this pin.

## Absolute Maximum Ratings

Stresses exceeding the absolute maximum ratings may damage the device. The device may not function or be operable above the recommended operating conditions and stressing the parts to these levels is not recommended. In addition, extended exposure to stresses above the recommended operating conditions may affect device reliability. The absolute maximum ratings are stress ratings only.  $T_A = 25^\circ\text{C}$  unless otherwise specified.

Symbol	Parameter	Value	Unit
$V_{CC}$	Supply Voltage	$V_Z$	V
$I_{OH}, I_{OL}$	Peak Drive Output Current	+500/-800	mA
$I_{clamp}$	Driver Output Clamping Diodes $V_O > V_{CC}$ or $V_O < -0.3V$	$\pm 10$	mA
$I_{det}$	Detector Clamping Diodes	$\pm 10$	mA
$V_{IN}$	Error Amplifier, MOT, CS Input Voltages	-0.3 to 8	V
$T_j$	Operating Junction Temperature	150	$^\circ\text{C}$
$T_A$	Operating Temperature Range	-40 to 125	$^\circ\text{C}$
$T_{stg}$	Storage Temperature Range	-65 to 150	$^\circ\text{C}$
$V_{ESD\_HBM}$	ESD Capability, Human Body Model	2.0	kV
$V_{ESD\_MM}$	ESD Capability, Machine Model	300	V
$V_{ESD\_CDM}$	ESD Capability, Charged Device Model	500	V

## Thermal Impedance<sup>(1)</sup>

Symbol	Parameter	Value	Unit	
$R\theta_{ja}$	Thermal Resistance, Junction-to-Ambient	8-DIP	110	$^\circ\text{C}/\text{W}$
		8-SOP	150	$^\circ\text{C}/\text{W}$

### Note:

- Regarding the test environment and PCB type, please refer to JESD51-2 and JESD51-10.

## Electrical Characteristics

$V_{CC} = 14V$ ,  $T_A = -40^{\circ}C \sim 125^{\circ}C$ , unless otherwise specified.

Symbol	Parameter	Condition	Min.	Typ.	Max.	Unit
<b>UNDER-VOLTAGE LOCKOUT SECTION</b>						
$V_{th(start)}$	Start Threshold Voltage	$V_{CC}$ increasing	11	12	13	V
$V_{th(stop)}$	Stop Threshold Voltage	$V_{CC}$ decreasing	7.5	8.5	9.5	V
$HY_{(uvlo)}$	UVLO Hysteresis		3.0	3.5	4.0	V
$V_Z$	Zener Voltage	$I_{CC} = 20mA$	20	22	24	V
<b>SUPPLY CURRENT SECTION</b>						
$I_{st}$	Start-up Supply Current	$V_{CC} = V_{th(start)} - 0.2V$		40	70	$\mu A$
$I_{CC}$	Operating Supply Current	Output no switching		1.5	3.0	mA
$I_{dCC}$	Dynamic Operating Supply Current	50kHz, $CI=1nF$		2.5	4.0	mA
$I_{CC(dis)}$	Operating Current at Disable	$V_{inv} = 0V$	20	65	95	$\mu A$
<b>ERROR AMPLIFIER SECTION</b>						
$V_{ref1}$	Voltage Feedback Input Threshold1	$T_A = 25^{\circ}C$	2.465	2.500	2.535	V
$\Delta V_{ref1}$	Line Regulation	$V_{CC} = 14V \sim 20V$		0.1	10.0	mV
$\Delta V_{ref2}$	Temperature Stability of $V_{ref1}^{(2)}$			20		mV
$I_{b(ea)}$	Input Bias Current	$V_{inv} = 1V \sim 4V$	-0.5		0.5	$\mu A$
$I_{source}$	Output Source Current	$V_{inv} = V_{ref1} - 0.1V$		-12		$\mu A$
$I_{sink}$	Output Sink Current	$V_{inv} = V_{ref1} + 0.1V$		12		$\mu A$
$V_{eao(H)}$	Output Upper Clamp Voltage	$V_{inv} = V_{ref1} - 0.1V$	5.4	6.0	6.6	V
$V_{eao(Z)}$	Zero Duty Cycle Output Voltage		0.9	1.0	1.1	V
$g_m$	Transconductance <sup>(2)</sup>		90	115	140	$\mu mho$
<b>MAXIMUM ON-TIME SECTION</b>						
$V_{mot}$	Maximum On-time Voltage	$R_{mot} = 40.5k\Omega$	2.784	2.900	3.016	V
$T_{on(max)}$	Maximum On-time Programming	$R_{mot} = 40.5k\Omega$ , $T_A = 25^{\circ}C$	19	24	29	$\mu s$
<b>CURRENT SENSE SECTION</b>						
$V_{CS(limit)}$	Current Sense Input Threshold Voltage Limit		0.7	0.8	0.9	V
$I_{b(cs)}$	Input Bias Current	$V_{CS} = 0V \sim 1V$	-1.0	-0.1	1.0	$\mu A$
$t_{d(cs)}$	Current Sense Delay to Output <sup>(2)</sup>	$dV/dt = 1V/100ns$ , From 0V to 5V		350	500	ns

### Note:

2. These parameters, although guaranteed by design, are not tested in mass production.

**Electrical Characteristics** (Continued)

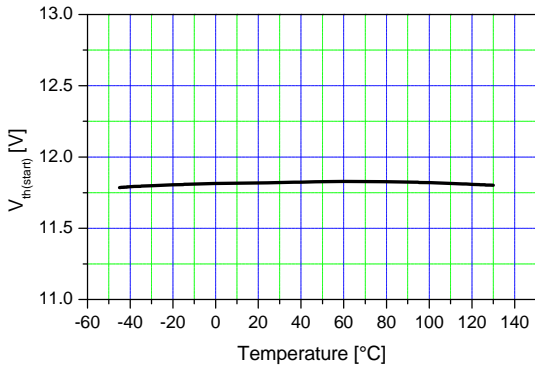
$V_{CC} = 14V$ ,  $T_A = -40^{\circ}C \sim 125^{\circ}C$ , unless otherwise specified.

Symbol	Parameter	Condition	Min.	Typ.	Max.	Unit
<b>ZERO CURRENT DETECT SECTION</b>						
$V_{th(ZCD)}$	Input Voltage Threshold <sup>(3)</sup>		1.35	1.50	1.65	V
$HY_{(ZCD)}$	Detect Hysteresis <sup>(3)</sup>		0.05	0.10	0.15	V
$V_{clamp(H)}$	Input High Clamp Voltage	$I_{det} = 3mA$	6.0	6.7	7.4	V
$V_{clamp(L)}$	Input Low Clamp Voltage	$I_{det} = -3mA$	0	0.65	1.00	V
$I_{b(ZCD)}$	Input Bias Current	$V_{ZCD} = 1V \sim 5V$	-1.0	-0.1	1.0	$\mu A$
$I_{source(zcd)}$	Source Current Capability <sup>(3)</sup>	$T_A = 25^{\circ}C$			-10	mA
$I_{sink(zcd)}$	Sink Current Capability <sup>(3)</sup>	$T_A = 25^{\circ}C$			10	mA
$t_{dead}$	Maximum Delay from ZCD to Output Turn-on <sup>(3)</sup>	$dV/dt = -1V/100ns$ , From 5V to 0V	100		200	ns
<b>OUTPUT SECTION</b>						
$V_{OH}$	Output Voltage High	$I_O = -100mA$ , $T_A = 25^{\circ}C$	9.2	11.0	12.8	V
$V_{OL}$	Output Voltage Low	$I_O = 200mA$ , $T_A = 25^{\circ}C$		1.0	2.5	V
$t_r$	Rising Time <sup>(3)</sup>	$Cl = 1nF$		50	100	ns
$t_f$	Falling Time <sup>(3)</sup>	$Cl = 1nF$		50	100	ns
$V_{O(max)}$	Maximum Output Voltage	$V_{CC} = 20V$ , $I_O = 100\mu A$	11.5	13.0	14.5	V
$V_{O(UVLO)}$	Output Voltage with UVLO Activated	$V_{CC} = 5V$ , $I_O = 100\mu A$			1	V
<b>RESTART TIMER SECTION</b>						
$t_{d(rst)}$	Restart Timer Delay		50	150	300	$\mu s$
<b>OVER-VOLTAGE PROTECTION SECTION</b>						
$V_{ovp}$	OVP Threshold Voltage	$T_A = 25^{\circ}C$	2.620	2.675	2.730	V
$HY_{(ovp)}$	OVP Hysteresis	$T_A = 25^{\circ}C$	0.120	0.175	0.230	V
<b>ENABLE SECTION</b>						
$V_{th(en)}$	Enable Threshold Voltage		0.40	0.45	0.50	V
$HY_{(en)}$	Enable Hysteresis		0.05	0.10	0.15	V

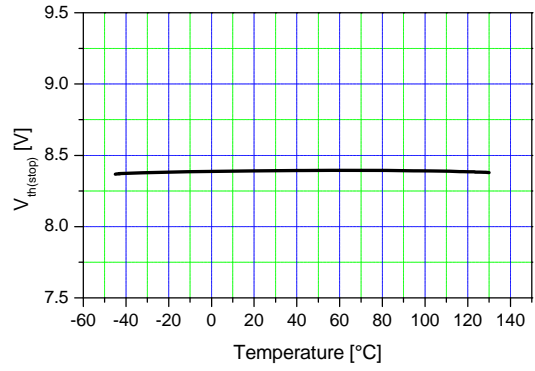
**Note:**

3. These parameters, although guaranteed by design, are not tested in mass production.

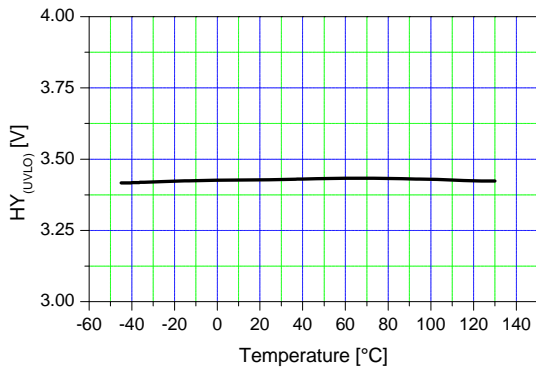
## Typical Characteristics



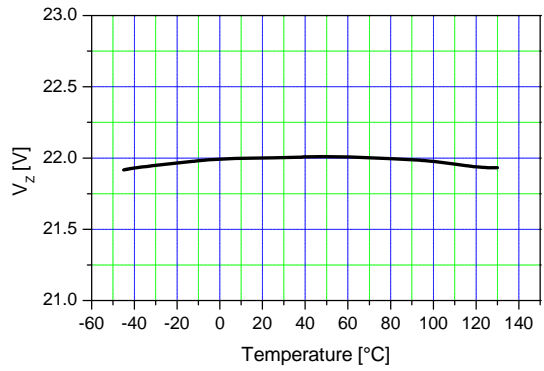
**Figure 4. Start Threshold Voltage vs. Temp.**



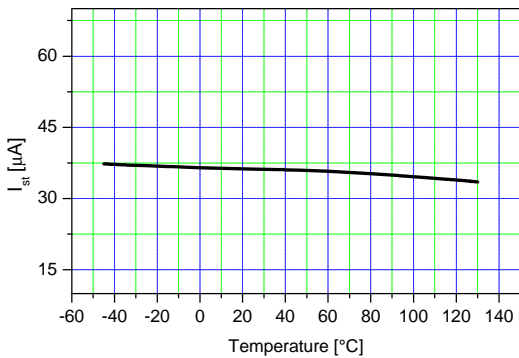
**Figure 5. Stop Threshold Voltage vs. Temp.**



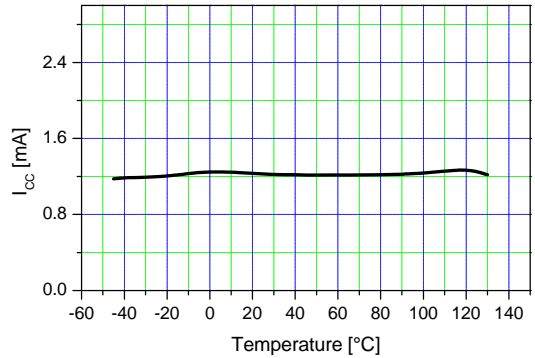
**Figure 6. UVLO Hysteresis vs. Temp.**



**Figure 7. Zener Voltage vs. Temp.**



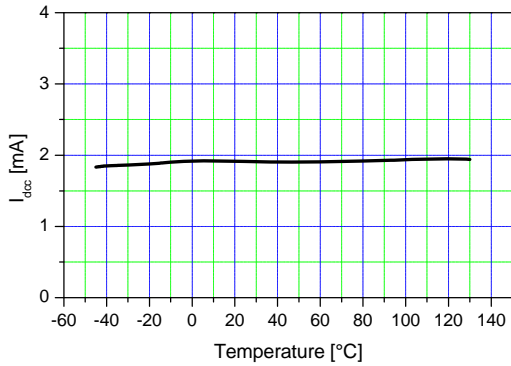
**Figure 8. Start-up Supply Current vs. Temp.**



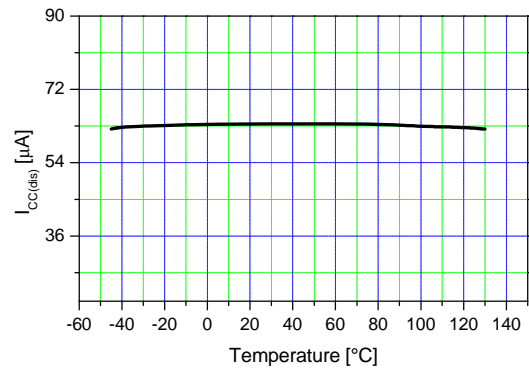
**Figure 9. Operating Supply Current vs. Temp.**



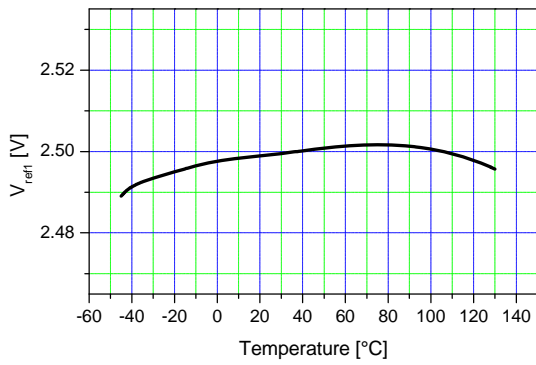
**Typical Characteristics (Continued)**



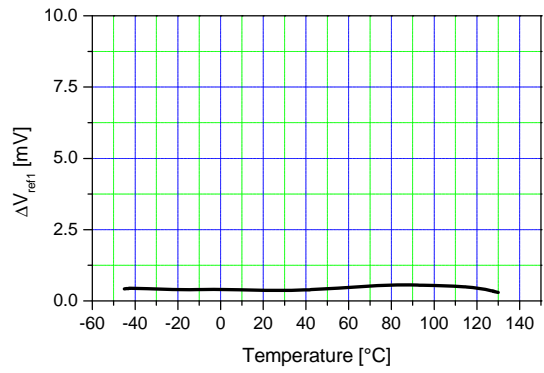
**Figure 10. Dynamic Operating Supply Current vs. Temp.**



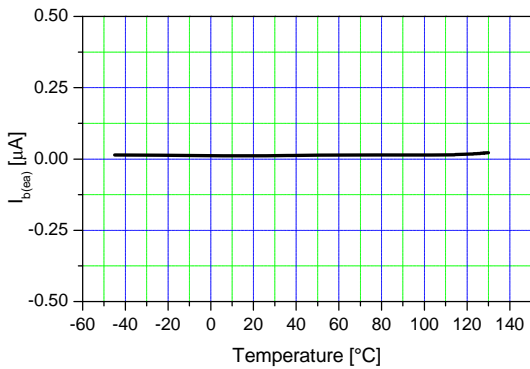
**Figure 11. Operating Current at Disable vs. Temp.**



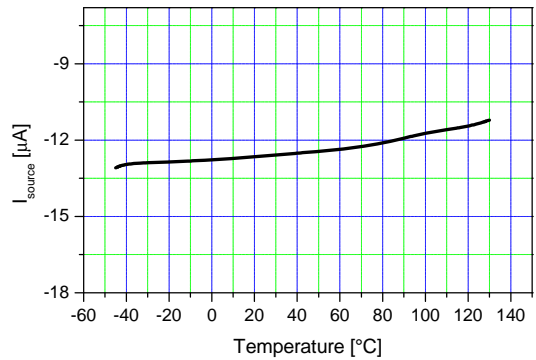
**Figure 12.  $V_{ref1}$  vs. Temp.**



**Figure 13.  $\Delta V_{ref1}$  vs. Temp.**

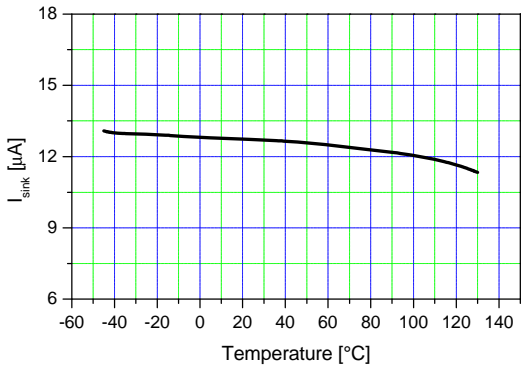


**Figure 14. Input Bias Current vs. Temp.**

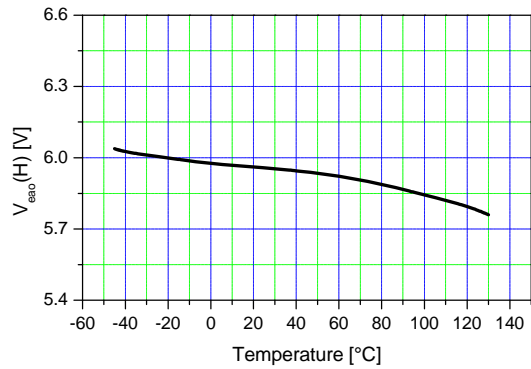


**Figure 15. Output Source Current vs. Temp.**

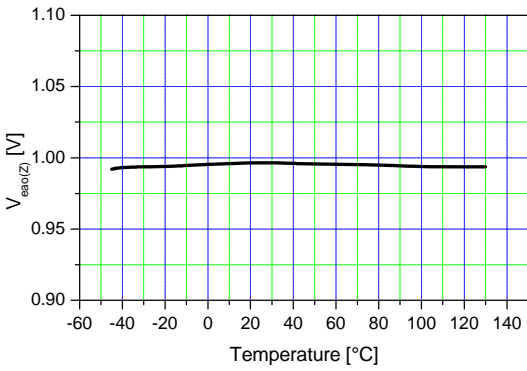
**Typical Characteristics (Continued)**



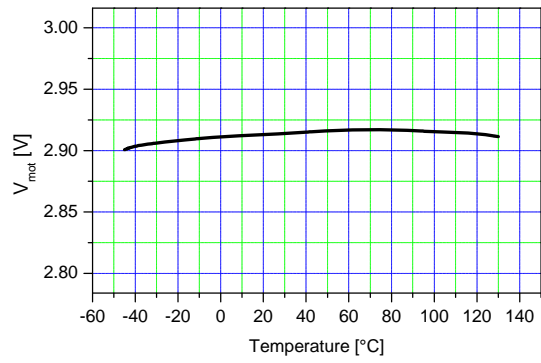
**Figure 16. Output Sink Current vs. Temp.**



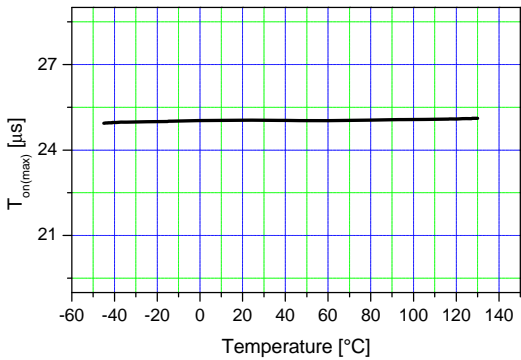
**Figure 17. Output Upper Clamp Voltage vs. Temp.**



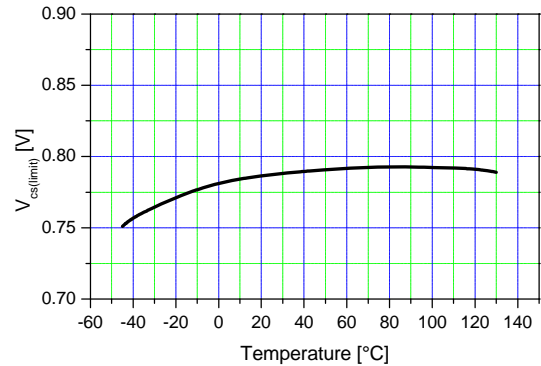
**Figure 18. Zero Duty Cycle Output Voltage vs. Temp.**



**Figure 19. Maximum On-Time Voltage vs. Temp.**



**Figure 20. Maximum On-Time vs. Temp.**



**Figure 21. Current Sense Input Threshold Voltage vs. Temp.**

Typical Characteristics (Continued)

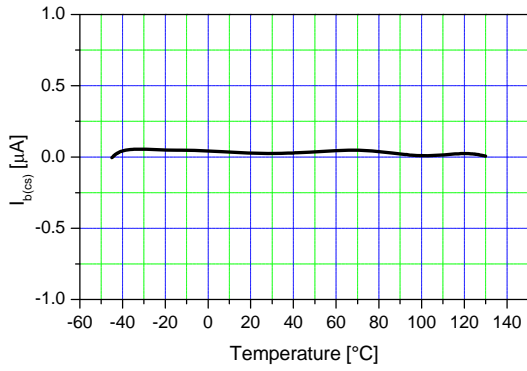


Figure 22. Input Bias Current vs. Temp.

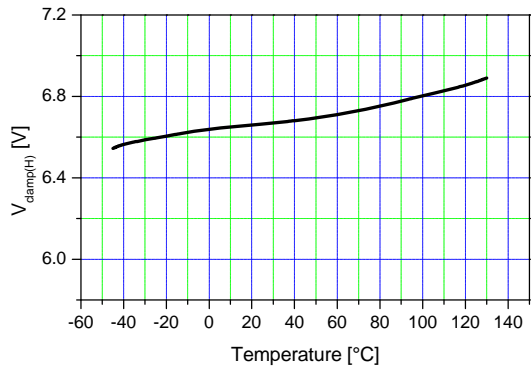


Figure 23. Input High Clamp Voltage vs. Temp.

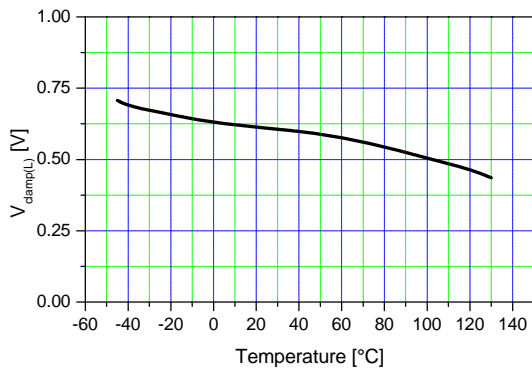


Figure 24. Input Low Clamp Voltage vs. Temp.

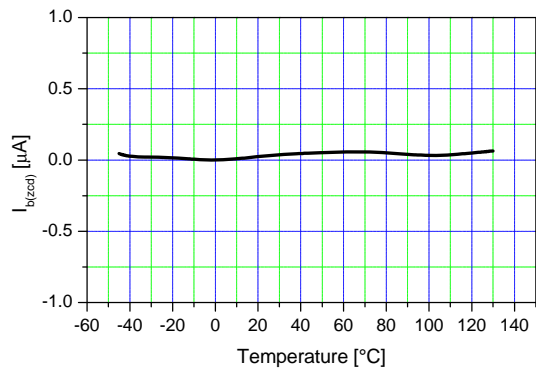


Figure 25. Input Bias Current vs. Temp.

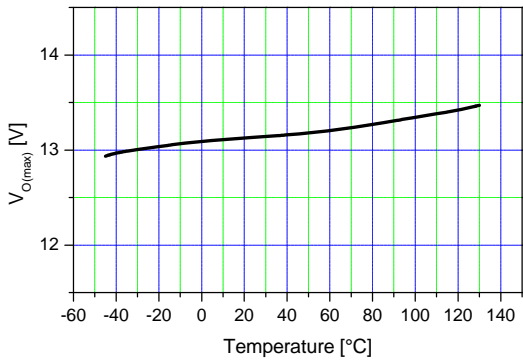


Figure 26. Maximum Output Voltage vs. Temp.

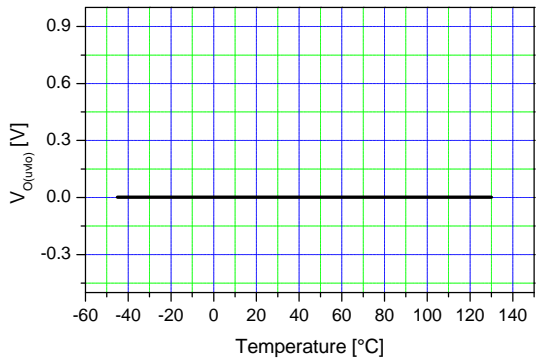
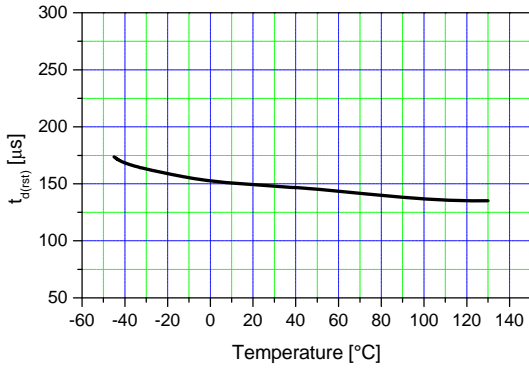
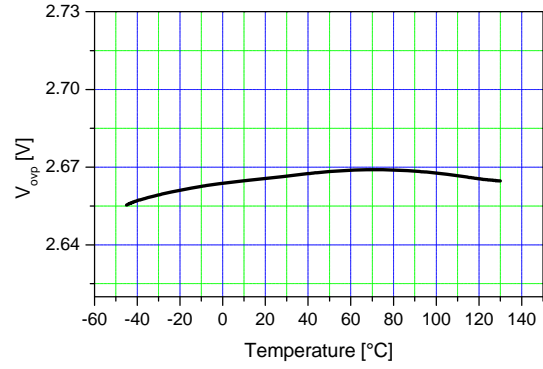


Figure 27. Output Voltage with UVLO Activated vs. Temp.

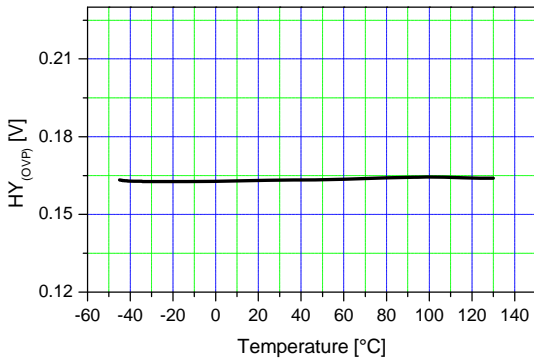
**Typical Characteristics (Continued)**



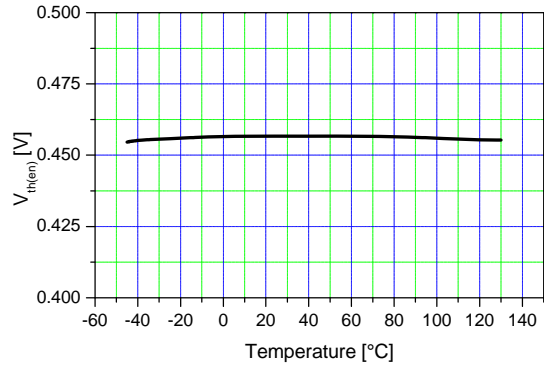
**Figure 28. Restart Delay Time vs. Temp.**



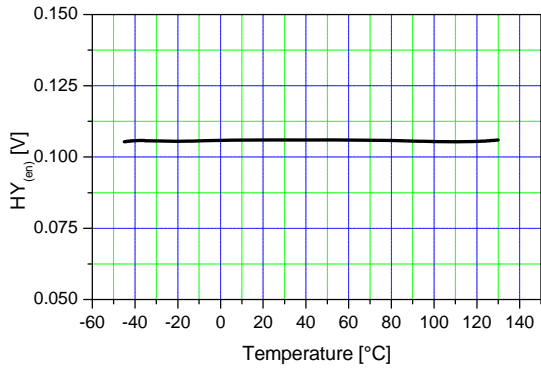
**Figure 29. OVP Threshold Voltage vs. Temp.**



**Figure 30. OVP Hysteresis vs. Temp.**



**Figure 31. Enable Threshold voltage vs. Temp.**



**Figure 32. Enable Hysteresis vs. Temp.**

## Applications Information

### 1. Error Amplifier Block

The error amplifier block consists of a transconductance amplifier, output OVP comparator, and disable comparator. For the output voltage control, a transconductance amplifier is used instead of the conventional voltage amplifier. The transconductance amplifier (voltage controlled current source) aids the implementation of OVP and disable function. The output current of the amplifier changes according to the voltage difference of the inverting and non-inverting input of the amplifier. The output voltage of the amplifier is compared with the internal ramp signal to generate the switch turn-off signal. The OVP comparator shuts down the output drive block when the voltage of the INV pin is higher than 2.675V and there is 0.175V hysteresis. The disable comparator disables the operation of the FAN7530 when the voltage of the inverting input is lower than 0.45V and there is 100mV hysteresis. An external small signal MOSFET can be used to disable the IC, as shown in Figure 33. The IC operating current decreases below 65μA to reduce power consumption if the IC is disabled.

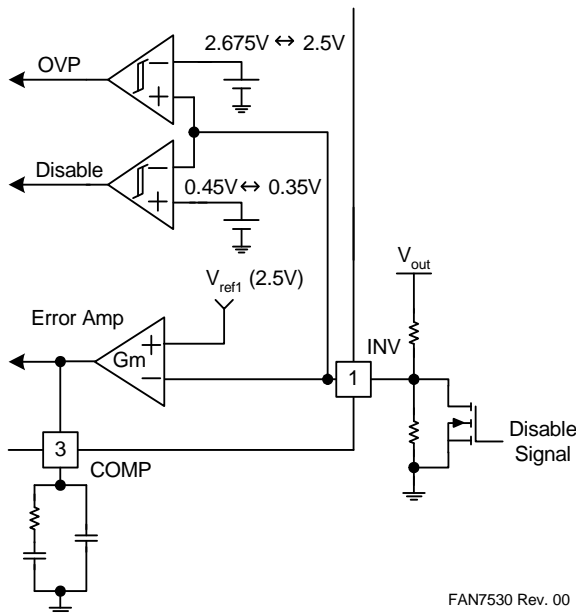


Figure 33. Error Amplifier Block

### 2. Zero Current Detection Block

The zero current detector (ZCD) generates the turn-on signal of the MOSFET when the boost inductor current reaches zero using an auxiliary winding coupled with the inductor. If the voltage of the ZCD pin goes higher than 1.5V, the ZCD comparator waits until the voltage goes below 1.4V. If the voltage goes below 1.4V, the zero cur-

rent detector turns on the MOSFET. The ZCD pin is protected internally by two clamps, 6.7V-high clamp and 0.65V-low clamp. The 150μs timer generates a MOSFET turn-on signal if the drive output has been low for more than 150μs from the falling edge of the drive output.

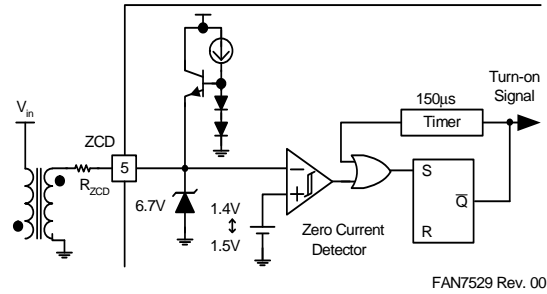


Figure 34. Zero Current Detector Block

### 3. Sawtooth Generator Block

The output of the error amplifier and the output of the sawtooth generator are compared to determine the MOSFET turn-off instance. The slope of the sawtooth is determined by an external resistor connected to the MOT pin. The voltage of the MOT pin is 2.9V and the slope is proportional to the current flowing out of the MOT pin. The internal ramp signal has a 1V offset; therefore, the drive output is shut down if the voltage of the COMP pin is lower than 1V. The MOSFET on-time is maximum when the COMP pin voltage is 5V. According to the slope of the internal ramp, the maximum on-time can be programmed. The necessary maximum on-time depends on the boost inductor, lowest AC line voltage, and maximum output power. The resistor value should be designed properly.

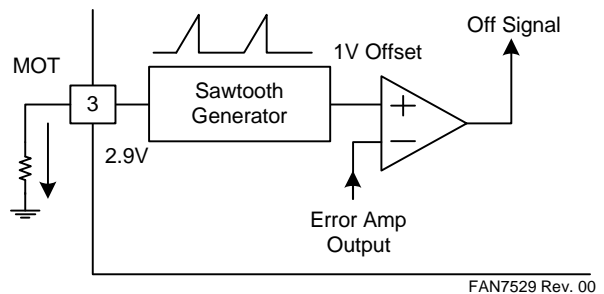
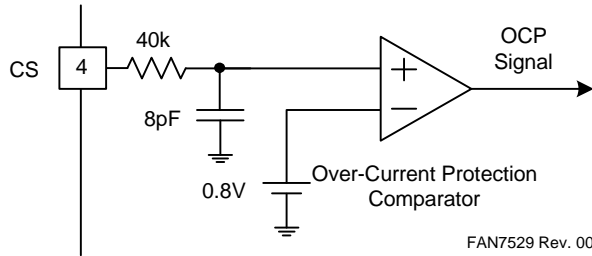


Figure 35. Sawtooth Generator Block

#### 4. Over-Current Protection Block

The MOSFET current is sensed using an external sensing resistor for the over-current protection. If the CS pin voltage is higher than 0.8V, the over-current protection comparator generates a protection signal. An internal RC filter is included to filter switching noise.



**Figure 36. Over-Current Protection Block**

#### 5. Switch Drive Block

The FAN7530 contains a single totem-pole output stage designed for a direct drive of the power MOSFET. The drive output is capable of up to +500/-800mA peak current with a typical rise and fall time of 50ns with 1nF load. The output voltage is clamped to 13V to protect the MOSFET gate even if the  $V_{CC}$  voltage is higher than 13V.

#### 6. Under-Voltage Lockout Block

If the  $V_{CC}$  voltage reaches 12V, the IC's internal blocks are enabled and start operation. If the  $V_{CC}$  voltage drops below 8.5V, most of the internal blocks are disabled to reduce the operating current.  $V_{CC}$  voltage should be higher than 8.5V under normal conditions.

### Typical application circuit

Application	Output Power	Input Voltage	Output Voltage
Ballast	100W	Universal input (85~265Vac)	400V

#### Features

- High efficiency (>90% at 85Vac input)
- Low THD (total harmonic distortion) (<10% at 265Vac input, 25W load)

#### Key Design Notes

- R1, R2, R5, C11 should be optimized for best THD characteristic.

#### 1. Schematic

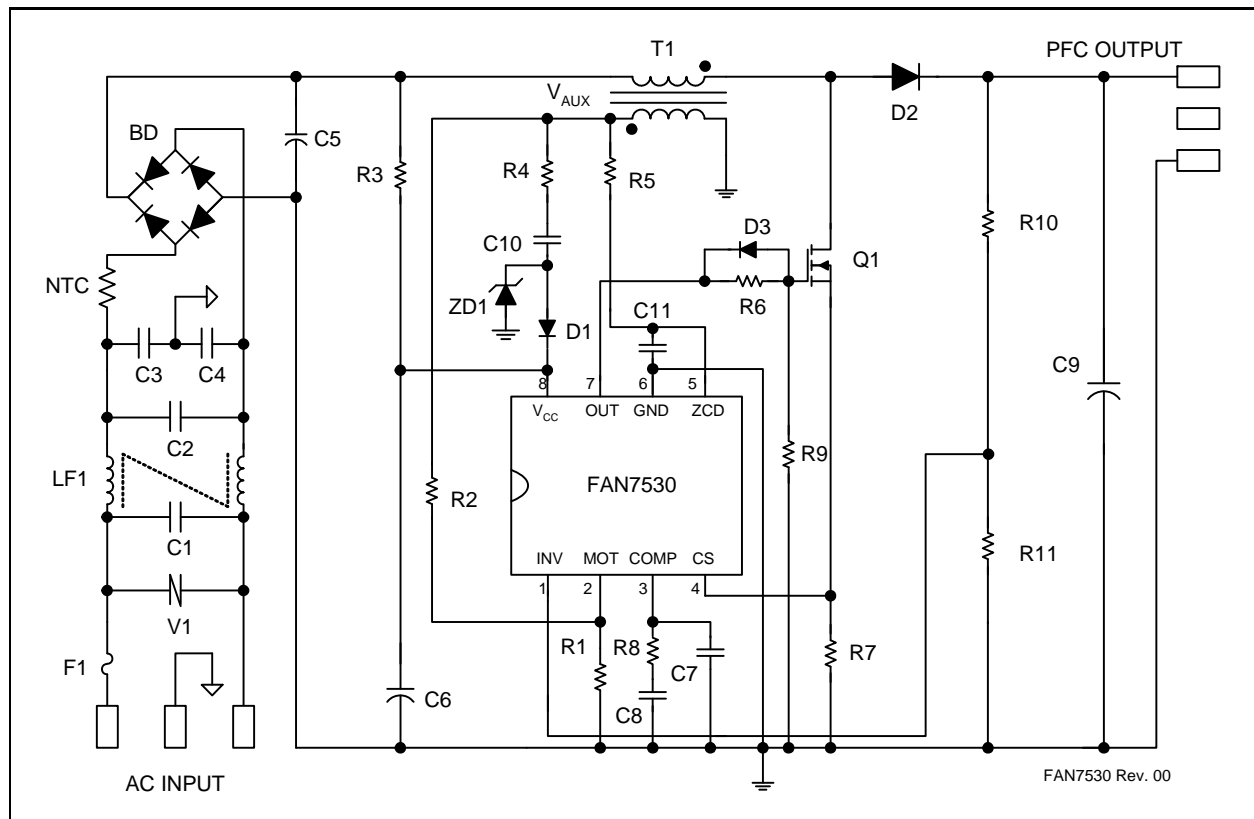


Figure 37. Schematic

## 2. Inductor Schematic Diagram

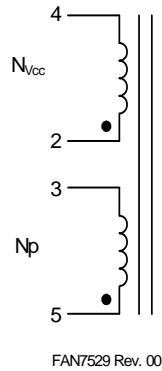


Figure 38. Inductor Schematic Diagram

## 3. Winding Specification

No	Pin (s→f)	Wire	Turns	Winding Method
N <sub>p</sub>	5 → 3	0.1 <sup>ϕ</sup> × 30	58	Solenoid Winding
Insulation: Polyester Tape t = 0.050mm, 4 Layers				
N <sub>Vcc</sub>	2 → 4	0.2 <sup>ϕ</sup> × 10	8	Solenoid Winding
Outer Insulation: Polyester Tape t = 0.050mm, 4 Layers				
Air Gap: 0.6mm for each leg				

## 4. Electrical Characteristics

	Pin	Specification	Remarks
Inductance	3 - 5	600μH ± 10%	100kHz, 1V

## 5. Core & Bobbin

- Core: EI 3026
- Bobbin: EI3026
- Ae(mm<sup>2</sup>): 111



### 6. Demo Circuit Part List

Part	Value	Note	Part	Value	Note
<b>Fuse</b>			<b>Inductor</b>		
F1	3A/250V		T1	600μH	EI3026
<b>NTC</b>			<b>MOSFET</b>		
NTC	10D-9		Q1	FQPF13N50C	Fairchild
<b>Resistor</b>			<b>Diode</b>		
R1	56kΩ	1/4W	D1	1N4148	Fairchild
R2	820kΩ	1/4W	D2	BYV26C	600V, 1A
R3	330kΩ	1/2W	D3	SB140	Fairchild
R4	150Ω	1/2W	ZD1	1N4746	18V
R5	20kΩ	1/4W	<b>Bridge Diode</b>		
R6	10Ω	1/4W	BD	KBL06	600V/4A
R7	0.2Ω	1/2W	<b>Line Filter</b>		
R8	10kΩ	1/4W	LF1	40mH	Wire 0.4mm
R9	10kΩ	1/4W	<b>IC</b>		
R10	2MΩ	1/4W	IC1	FAN7530	Fairchild
R11	12.9kΩ	1/4W	<b>TNR</b>		
<b>Capacitor</b>			V1	471	470V
C1	150nF/275VAC	Box Capacitor			
C2	470nF/275VAC	Box Capacitor			
C3	2.2nF/3kV	Ceramic Capacitor			
C4	2.2nF/3kV	Ceramic Capacitor			
C5					
C6	47μF/25V	Electrolytic Capacitor			
C7	47nF/50V	Ceramic Capacitor			
C8	220nF/50V	Multilayer Ceramic Capacitor			
C9	100μF/450V	Electrolytic Capacitor			
C10	12nF/100V	Film Capacitor			
C11	56pF/50V	Ceramic Capacitor			

### 7. Layout

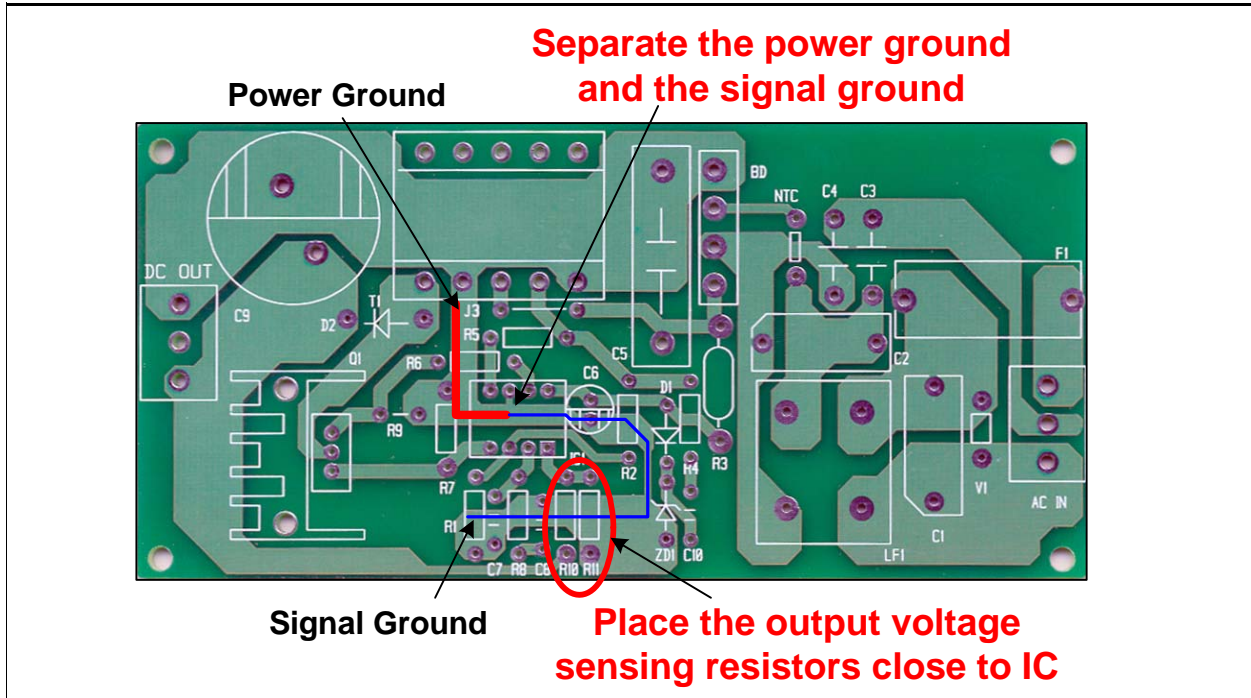
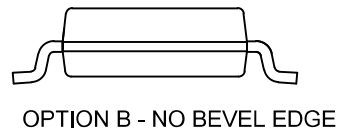
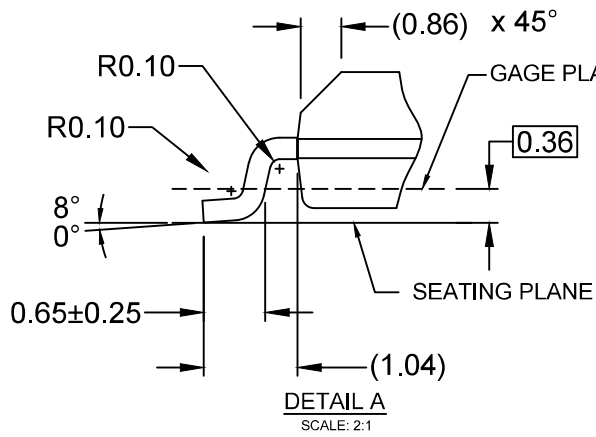
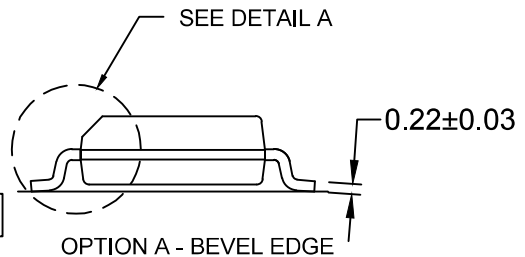
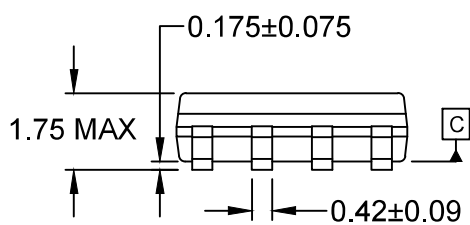
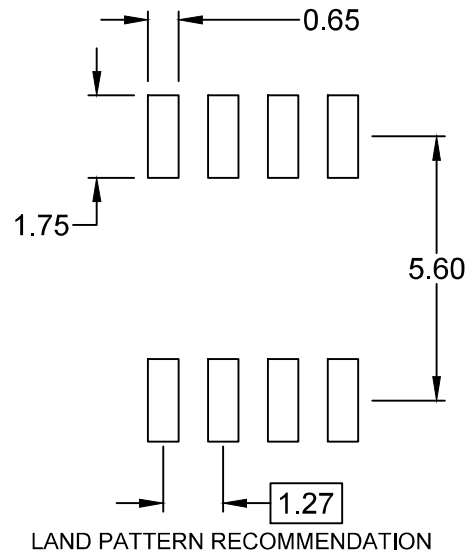


Figure 39. PCB Layout Considerations for FAN7530

### 8. Performance Data

<b>P<sub>OUT</sub></b>		<b>85Vac</b>	<b>115Vac</b>	<b>230Vac</b>	<b>265Vac</b>
100W	PF	0.998	0.998	0.991	0.984
	THD	5.1%	3.6%	5.2%	6.2%
	Efficiency	90.9%	93.7%	95.6%	96%
75W	PF	0.999	0.998	0.986	0.975
	THD	4.1%	3.6%	5.0%	5.7%
	Efficiency	91.6%	93.3%	94.6%	95.3%
50W	PF	0.998	0.997	0.974	0.956
	THD	4.4%	5.0%	5.7%	6.2%
	Efficiency	91.3%	91.9%	92.7%	93.4%
25W	PF	0.995	0.991	0.923	0.876
	THD	7.9%	8.6%	8.3%	8.7%
	Efficiency	86.4%	87.1%	87.3%	88.1%



- NOTES:
- A) THIS PACKAGE CONFORMS TO JEDEC MS-012, VARIATION AA.
  - B) ALL DIMENSIONS ARE IN MILLIMETERS.
  - C) DIMENSIONS DO NOT INCLUDE MOLD FLASH OR BURRS.
  - D) LANDPATTERN STANDARD: SOIC127P600X175-8M
  - E) DRAWING FILENAME: M08Arev16



ON Semiconductor and  are trademarks of Semiconductor Components Industries, LLC dba ON Semiconductor or its subsidiaries in the United States and/or other countries. ON Semiconductor owns the rights to a number of patents, trademarks, copyrights, trade secrets, and other intellectual property. A listing of ON Semiconductor's product/patent coverage may be accessed at [www.onsemi.com/site/pdf/Patent-Marking.pdf](http://www.onsemi.com/site/pdf/Patent-Marking.pdf). ON Semiconductor reserves the right to make changes without further notice to any products herein. ON Semiconductor makes no warranty, representation or guarantee regarding the suitability of its products for any particular purpose, nor does ON Semiconductor assume any liability arising out of the application or use of any product or circuit, and specifically disclaims any and all liability, including without limitation special, consequential or incidental damages. Buyer is responsible for its products and applications using ON Semiconductor products, including compliance with all laws, regulations and safety requirements or standards, regardless of any support or applications information provided by ON Semiconductor. "Typical" parameters which may be provided in ON Semiconductor data sheets and/or specifications can and do vary in different applications and actual performance may vary over time. All operating parameters, including "Typicals" must be validated for each customer application by customer's technical experts. ON Semiconductor does not convey any license under its patent rights nor the rights of others. ON Semiconductor products are not designed, intended, or authorized for use as a critical component in life support systems or any FDA Class 3 medical devices or medical devices with a same or similar classification in a foreign jurisdiction or any devices intended for implantation in the human body. Should Buyer purchase or use ON Semiconductor products for any such unintended or unauthorized application, Buyer shall indemnify and hold ON Semiconductor and its officers, employees, subsidiaries, affiliates, and distributors harmless against all claims, costs, damages, and expenses, and reasonable attorney fees arising out of, directly or indirectly, any claim of personal injury or death associated with such unintended or unauthorized use, even if such claim alleges that ON Semiconductor was negligent regarding the design or manufacture of the part. ON Semiconductor is an Equal Opportunity/Affirmative Action Employer. This literature is subject to all applicable copyright laws and is not for resale in any manner.

## PUBLICATION ORDERING INFORMATION

### LITERATURE FULFILLMENT:

Literature Distribution Center for ON Semiconductor  
19521 E. 32nd Pkwy, Aurora, Colorado 80011 USA  
**Phone:** 303-675-2175 or 800-344-3860 Toll Free USA/Canada  
**Fax:** 303-675-2176 or 800-344-3867 Toll Free USA/Canada  
**Email:** [orderlit@onsemi.com](mailto:orderlit@onsemi.com)

**N. American Technical Support:** 800-282-9855 Toll Free  
USA/Canada  
**Europe, Middle East and Africa Technical Support:**  
Phone: 421 33 790 2910  
**Japan Customer Focus Center**  
Phone: 81-3-5817-1050

**ON Semiconductor Website:** [www.onsemi.com](http://www.onsemi.com)  
**Order Literature:** <http://www.onsemi.com/orderlit>  
For additional information, please contact your local  
Sales Representative

# Mouser Electronics

Authorized Distributor

Click to View Pricing, Inventory, Delivery & Lifecycle Information:

[ON Semiconductor:](#)

[FAN7530M](#) [FAN7530MX](#) [FAN7530N](#)

## Данный компонент на территории Российской Федерации

### Вы можете приобрести в компании MosChip.

Для оперативного оформления запроса Вам необходимо перейти по данной ссылке:

<http://moschip.ru/get-element>

Вы можете разместить у нас заказ для любого Вашего проекта, будь то серийное производство или разработка единичного прибора.

В нашем ассортименте представлены ведущие мировые производители активных и пассивных электронных компонентов.

Нашей специализацией является поставка электронной компонентной базы двойного назначения, продукции таких производителей как XILINX, Intel (ex.ALTERA), Vicor, Microchip, Texas Instruments, Analog Devices, Mini-Circuits, Amphenol, Glenair.

Сотрудничество с глобальными дистрибьюторами электронных компонентов, предоставляет возможность заказывать и получать с международных складов практически любой перечень компонентов в оптимальные для Вас сроки.

На всех этапах разработки и производства наши партнеры могут получить квалифицированную поддержку опытных инженеров.

Система менеджмента качества компании отвечает требованиям в соответствии с ГОСТ Р ИСО 9001, ГОСТ РВ 0015-002 и ЭС РД 009

### Офис по работе с юридическими лицами:

105318, г.Москва, ул.Щербаковская д.3, офис 1107, 1118, ДЦ «Щербаковский»

Телефон: +7 495 668-12-70 (многоканальный)

Факс: +7 495 668-12-70 (доб.304)

E-mail: [info@moschip.ru](mailto:info@moschip.ru)

Skype отдела продаж:

moschip.ru

moschip.ru\_4

moschip.ru\_6

moschip.ru\_9