









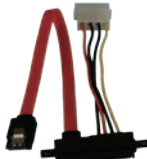

# Cables and Connectors *FDD / HDD cable*

SATA HDD cable			
			
<b>Model Name</b>	<b>32000-062800-RS</b>	<b>32102-000100-100-RS</b>	<b>32000-080700-RS</b>
Cable type	SATA HDD cable	SATA power cable	SATA + Power cable
Connector	SATA 7-pin	4-pin model + 2 x SATA 15-pin	SATA 7-pin + 4-pin model
Connector type	Lockable	SATA power connector	
Length	50 cm	15 cm	SATA cable 20 cm Power cable 10 cm

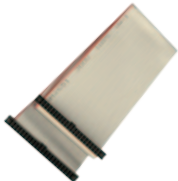

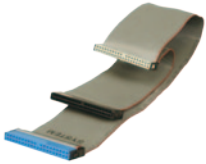
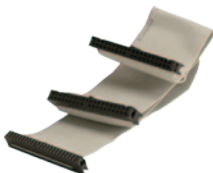

SATA HDD cable		IDE HDD cable	
			
<b>Model Name</b>	<b>32801-000201-100-RS</b>	<b>32801-000100-100-RS</b>	<b>32200-000009-RS</b>
Cable type	SATA + Power cable	SATA + Power cable	IDE HDD flat cable
Connector	SATA 7-pin + 2-pin wafer 2.0mm	SATA 7-pin + 4-pin wafer 2.54mm	44p-44p
Connector type	2-pin PH 2.0	4-pin PH 2.54 mm	2.0mm -2.0mm
Length	SATA cable 15 cm Power cable 15 cm	SATA cable 20 cm Power cable 20 cm	40 cm





IDE HDD cable			
			
<b>Model Name</b>	<b>32221-001000-101-RS</b>	<b>32200-025001-RS</b>	<b>32225-002000-100-RS</b>
Cable type	IDE HDD flat cable	IDE HDD flat cable	ATA-66 HDD flat cable
Connector	44p-44p	44p-40p-40p	40p-40p-40p
Connector type	2.0mm -2.0mm	2.0mm-2.54mm-2.54mm	2.54mm
Length	25 cm	20 cm + 15 cm	30 cm + 15 cm







IDE HDD cable			
			
<b>Model Name</b>	<b>32221-001700-100-RS</b>	<b>CB-HD32-RS</b>	<b>CVT-4044-RS</b>
Cable type	ATA-33 HDD flat cable	IDE HDD flat cable	IDE adapter
Connector	44p-40p-40p	40p-44p	40p-44p
Connector type	2.0mm-2.54mm-2.54mm	2.54mm-2.0mm	2.54mm-2.0mm
Length	20 cm + 15 cm	IDE cable: 39 cm Power cable: 20 cm	Power cable: 20 cm





Part numbers listed in the product catalog are for reference purposes. IEI reserves the right to implement substitution parts when the function is not affected.

# Cables and Connectors *Paralle / Serial cable*

	Serial cable				
					
<b>Model Name</b>	<b>45002-008103-RS</b>	<b>19800-000300-100-RS</b>	<b>19800-000114-RS</b>	<b>19800-000051-RS</b>	<b>19800-003600-100-RS</b>
Cable type	Serial port	Serial port cable	Serial port cable	Serial port cable	Serial port cable
Board side	N/A	10-pin (2x5) connector (2.0 mm)	10-pin (2x5) connector (2.54 mm)	2 x 10-pin (2x5) connector (2.54 mm)	2 x 10-pin (2x5) connector (2.54mm)
Board side pitch	2.54 mm	2.0 mm	2.54 mm	2.54 mm	2.54 mm
Device side	2 x DE9M	DE9M	DE9M	2 x DE9M	2 x DE9M
Bracket	Yes	Yes	Yes	Yes	Yes
Length	9 CM	30 cm	50 cm	23 cm	40 cm





	Serial cable				
					
<b>Model Name</b>	<b>19800-000112-RS</b>	<b>32205-000702-100-RS</b>	<b>32200-000049-RS</b>	<b>32205-001203-100-RS</b>	<b>32205-002000-100-RS</b>
Cable type	Serial port cable	Serial port cable	Serial port cable	Serial port cable	Serial port cable
Board side	2 x 10-pin (2x5) connector (2.0 mm)	10-pin (2x5) connector (2.54 mm)	10-pin (2x5) connector (2.0 mm)	40-pin (2x20) connector (2.54 mm)	40-pin (2x20) connector (2.0 mm)
Board side pitch	2.0 mm	2.54 mm	2.0 mm	2.54 mm	2.0 mm
Device side	2 x DE9M	DE9M	DE9M	4 x DE9M	4 x DE9M
Bracket	Yes	No	No	No	No
Length	30 cm	23 cm	20 cm	40/40/40/40 cm	30 cm





	Serial cable					
						
<b>Model Name</b>	<b>32205-001800-200-RS</b>	<b>32205-002500-100-RS</b>	<b>19800-004400-100-RS</b>	<b>19800-004300-100-RS</b>	<b>32205-000300-100-RS</b>	<b>32205-003700-100-RS</b>
Cable type	Serial port cable	RS-422/485 cable	RS-232 & RS-422/485 cable	RS-232 & RS-422/485 cable	RS-232 & RS-422/485 cable	RS-232 & RS-422/485 cable
Board side	40-pin (2x20) connector (2.0 mm)	16-pin (2x8) connector (2.54 mm)	14-pin (2x7) connector (2.54 mm)	14-pin (2x7) connector (2.0 mm)	14-pin (2x7) connector (2.0 mm)	14-pin (2x7) connector (2.0 mm)
Board side pitch	2.0 mm	2.54 mm	2.54 mm	2.0 mm	2.0 mm	2.0 mm
Device side	4 x DE9M	4 x DE9M	2 x DE9M	2 x DE9M	2 x DE9M	2 x DE9M
Bracket	No	No	Yes	Yes	No	No
Length	30 cm	12 cm	25.5 cm	25 cm	29 cm	23 cm

	Serial cable	Paralle cable			
					
<b>Model Name</b>	<b>32205-003800-100-RS</b>	<b>19800-000049-RS</b>	<b>19800-000142-00-RS</b>	<b>19800-003500-100-RS</b>	<b>32200-015100-RS</b>
Cable type	RS-422/485 cable	Parallel port cable	Parallel and serial port cable	Parallel and serial port cable	Parallel port cable
Board side	4-pin (1x4) connector (2.0 mm)	26-pin (2x13) connector (2.54 mm)	26-pin (2x13) connector (2.54 mm) 10-pin (2x5) connector (2.54 mm)	26-pin (2x13) connector (2.0 mm) 10-pin (2x5) connector (2.0 mm)	26-pin (2x13) connector (2.0 mm)
Board side pitch	2.0 mm	2.54 mm	2.54 mm	2.0 mm	2.0 mm
Device side	DE9M	DB25F	DB25F + DE9M	DB25F + DE9M	DB25F
Bracket	No	Yes	Yes	Yes	No
Length	20 cm	24 cm	24 cm	24 cm	28 cm



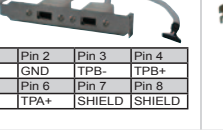

Part numbers listed in the product catalog are for reference purposes. IEI reserves the right to implement substitution parts when the function is not affected.





# Cables and Connectors *USB / 1394 / Y Cable*

	USB cable				
					
<b>Model Name</b>	<b>32001-010800-100-RS</b>	<b>32001-006404-100-RS</b>	<b>19800-000100-200-RS</b>	<b>19800-003100-300-RS</b>	<b>19800-003000-200-RS</b>
Cable type	USB cable	USB cable	USB cable	USB cable	USB cable
Board side	2 x 4pin connector (2.0mm)	2 x 4pin connector (2.0mm)	2 x 4-pin (2x4) connector (2.54mm)	2 x 4-pin (1x4) connector (2.54mm)	1 x 8-pin (2x4) connector (2.0mm)
Board side pitch	2.54mm	2.00mm	2.54mm	2.54mm	2.0mm
Device side	2 x USB	2 x USB	4 x USB	2 x USB	2 x USB
Bracket	No	No	Yes	Yes	Yes
Length	20cm	22cm	30 cm	30 cm	30 cm

	USB cable			1394 cable	
					
<b>Model Name</b>	<b>32000-044300-RS</b>	<b>32000-073400-RS</b>	<b>32000-070301-RS</b>	<b>CB-IEEE1394-RS</b>	<b>19800-000103-RS</b>
Cable type	USB cable	USB cable	USB cable	1394 cable	1394 cable
Board side	1 x 8-pin (2x4) connector (2.54mm)	2 x 5-pin connector (2.0mm) for WAFER-8523, WAFER-945GSE3 only	1 x 8-pin (2x4) connector (2.0mm)	2 x 8-pin (1x8) connector (2.0mm)	1 x 8-pin (1x8) connector (2.0mm)
Board side pitch	2.54mm	2.0mm	2.0mm	2.0 mm	2.0 mm
Device side	2 x USB	2 x USB	2 x USB	2 x IEEE1394	1 x IEEE1394
Bracket	No	No	No	Yes	Yes
Length	21 cm	40 cm	21 cm	21 cm	25 cm



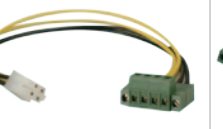

Pin 1	Pin 2	Pin 3	Pin 4
+12V	GND	TPB-	TPB+
Pin 5	Pin 6	Pin 7	Pin 8
TPA-	TPA+	SHIELD	SHIELD





	Keyboard / Mouse cable				
					
<b>Model Name</b>	<b>19800-000066-RS</b>	<b>19800-000075-RS</b>	<b>32006-000300-100-RS</b>	<b>32000-043301-RS</b>	<b>32006-001100-100-RS</b>
Cable type	Keyboard and mouse cable	Y-Cable	Y-Cable	Y-Cable	Y-Cable
Board side	2 x 5-pin (1x5) connector (2.54mm)	1 x 6-pin (1x6) connector (2.0mm)	1 x male PS/2	1 x 6-pin (1x6) connector (2.54mm)	1 x 6-pin (1x6) connector (2.0mm)
Board side pitch	2.54mm	2.0mm		2.54mm	2.0mm
Device side	2 x Female PS/2	2 x Female PS/2	2 x Female PS/2	2 x Female PS/2	2 x Female PS/2
Bracket	Yes	Yes	No	No	No
Length	30 cm	22 cm	12 cm (KB) + 14 (MS)	60 cm	13 cm

	Power cable				
					
<b>Model Name</b>	<b>32100-087100-RS</b>	<b>32102-022100-100-RS</b>	<b>32102-005100-200-RS</b>	<b>32100-192900-RS</b>	<b>32100-130300-RS</b>
Cable type	12V power cable	ATX function cable	12V power cable	12V power cable	Power cable for PC/104 CPU module
Board side	1 x 4-pin (2x2) connector	1 x 20-pin ATX power connector	1 x 4-pin (2x2) connector	1 x 4-pin (2x2) connector	1 x 4-pin (1x4) molex
Device side	2 x 4-pin (1x4) molex	1 x 4-pin (1x4) molex 1 x 3-pin PS_ON connector	with lock screw	4-pin 3.5 mm terminal block	3-pin 3.5 mm terminal block
Bracket	No	No	No	No	No
Length	13 cm	30 cm	25cm	25 cm	10 cm

Part numbers listed in the product catalog are for reference purposes. IEI reserves the right to implement substitution parts when the function is not affected.

## Cables and Connectors *Audio / LAN / VGA / Adapter Cable*

	Audio cable				
					
<b>Model Name</b>	<b>19800-000043-RS</b>	<b>19800-000800-100-RS</b>	<b>19800-000111-RS</b>	<b>32207-000100-100-RS</b>	<b>32007-002700-100-RS</b>
<b>Cable type</b>	Audio and Serial cable	Audio cable	Audio cable	Audio cable	Audio cable
<b>Board side</b>	Audio cable : 4-pin (1x4) connector (2.54mm) Serial cable : 10-pin (2x5) connector (2.0mm)	12-pin (2x6) connector (2.0mm)	10-pin (2x5) connector (2.0mm)	10-pin (2x5) connector (2.54 mm)	16-pin (2x8) connector (2.0mm)
<b>Board side pitch</b>	Audio : 2.54mm Serial cable : 2.0mm	2.0mm	2.0mm	2.54 mm	2.0mm
<b>Device side</b>	2 x Audio jacks / 1 x DE9M	4 x Audio jacks	3 x Audio jacks	10-pin (2x5) dupon	3 x Audio jacks
<b>Bracket</b>	Yes	Yes	Yes	No	No
<b>Length</b>	30 cm	25 cm	30 cm	40 cm	25 cm



	Audio cable	LAN cable	VGA cable		
					
<b>Model Name</b>	<b>32007-002600-100-RS</b>	<b>32000-028800-RS</b>	<b>32013-001700-100-RS</b>	<b>32003-000800-100-RS</b>	<b>32003-000900-100-RS</b>
<b>Cable type</b>	Audio cable	Audio cable	LAN cable	VGA cable	VGA cable
<b>Board side</b>	10-pin (2x5) connector (2.0mm)	12-pin (2x6) connector (2.54mm)	10-pin (2x5) connector (2.0mm)	10-pin (2x5) connector (2.54mm)	10-pin (2x5) connector (2.0mm)
<b>Board side pitch</b>	2.0mm	2.54mm	2.0mm	2.54mm	2.0mm
<b>Device side</b>	3 x Audio jacks	4 x Audio jacks	1 x RJ-45	1 x DB15F	1 x DB15F
<b>Bracket</b>	No	No	No	No	No
<b>Length</b>	30 cm	25 cm	31 cm	30 cm	30 cm

Part numbers listed in the product catalog are for reference purposes. IEI reserves the right to implement substitution parts when the function is not affected.

## Rackmount Slide *Chassis optional Accessories*

	SLIDE		
			
<b>Model Name</b>	<b>SLIDE-18</b>	<b>SLIDE-24</b>	<b>EXTENDER-6</b>
<b>Specification</b>	18" rackmount slide	24" rackmount slide	6" extender
<b>Description</b>	For rackmount chassis w/ depth up to 500	For rackmount chassis w/ depth up to 500	For 18" or 24" slider

## DIN Rail Kit

	KIT	
		
<b>Model Name</b>	<b>DK-100-R10</b>	<b>DK-84MB</b>
<b>Specification</b>	110(W) X 100(D) mm	168(W) X 96(D) mm
<b>Description</b>	VESA 100 to DIN-Rail kit	DIN mount kit for ECW-281 series, black, RoHS

## Данный компонент на территории Российской Федерации

### Вы можете приобрести в компании MosChip.

Для оперативного оформления запроса Вам необходимо перейти по данной ссылке:

<http://moschip.ru/get-element>

Вы можете разместить у нас заказ для любого Вашего проекта, будь то серийное производство или разработка единичного прибора.

В нашем ассортименте представлены ведущие мировые производители активных и пассивных электронных компонентов.

Нашей специализацией является поставка электронной компонентной базы двойного назначения, продукции таких производителей как XILINX, Intel (ex.ALTERA), Vicor, Microchip, Texas Instruments, Analog Devices, Mini-Circuits, Amphenol, Glenair.

Сотрудничество с глобальными дистрибьюторами электронных компонентов, предоставляет возможность заказывать и получать с международных складов практически любой перечень компонентов в оптимальные для Вас сроки.

На всех этапах разработки и производства наши партнеры могут получить квалифицированную поддержку опытных инженеров.

Система менеджмента качества компании отвечает требованиям в соответствии с ГОСТ Р ИСО 9001, ГОСТ РВ 0015-002 и ЭС РД 009

### Офис по работе с юридическими лицами:

105318, г.Москва, ул.Щербаковская д.3, офис 1107, 1118, ДЦ «Щербаковский»

Телефон: +7 495 668-12-70 (многоканальный)

Факс: +7 495 668-12-70 (доб.304)

E-mail: [info@moschip.ru](mailto:info@moschip.ru)

Skype отдела продаж:

moschip.ru

moschip.ru\_4

moschip.ru\_6

moschip.ru\_9