

### Super Junction MOSFET

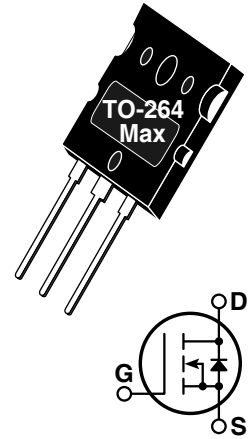

- Ultra low  $R_{DS(ON)}$
- Low Miller Capacitance
- Ultra Low Gate Charge,  $Q_g$
- Avalanche Energy Rated
- TO-264 Max Package

Unless stated otherwise, Microsemi discrete MOSFETs contain a single MOSFET die. This device is made with two parallel MOSFET die. It is intended for switch-mode operation. It is not suitable for linear mode operation.



#### MAXIMUM RATINGS

All Ratings:  $T_C = 25^\circ\text{C}$  unless otherwise specified.

Symbol	Parameter	APT94N60L2C3	UNIT
$V_{DSS}$	Drain-Source Voltage	600	Volts
$I_D$	Continuous Drain Current @ $T_C = 25^\circ\text{C}$	94	Amps
$I_{DM}$	Pulsed Drain Current <sup>①</sup>	282	
$V_{GS}$	Gate-Source Voltage Continuous	$\pm 20$	Volts
$V_{GSM}$	Gate-Source Voltage Transient	$\pm 30$	
$P_D$	Total Power Dissipation @ $T_C = 25^\circ\text{C}$	833	Watts
	Linear Derating Factor	6.67	W/ $^\circ\text{C}$
$T_J, T_{STG}$	Operating and Storage Junction Temperature Range	-55 to 150	$^\circ\text{C}$
$T_L$	Lead Temperature: 0.063" from Case for 10 Sec.	300	
$dv/dt$	Drain-Source Voltage slope ( $V_{DS} = 480\text{V}$ , $I_D = 94\text{A}$ , $T_J = 125^\circ\text{C}$ )	50	V/ns
$I_{AR}$	Repetitive Avalanche Current <sup>⑦</sup>	20	Amps
$E_{AR}$	Repetitive Avalanche Energy <sup>⑦</sup>	1	mJ
$E_{AS}$	Single Pulse Avalanche Energy <sup>④</sup>	1800	

#### STATIC ELECTRICAL CHARACTERISTICS

Symbol	Characteristic / Test Conditions	MIN	TYP	MAX	UNIT
$BV_{DSS}$	Drain-Source Breakdown Voltage ( $V_{GS} = 0\text{V}$ , $I_D = 500\mu\text{A}$ )	600			Volts
$R_{DS(on)}$	Drain-Source On-State Resistance <sup>②</sup> ( $V_{GS} = 10\text{V}$ , $60\text{A}$ )		0.03	0.035	Ohms
$I_{DSS}$	Zero Gate Voltage Drain Current ( $V_{DS} = 600\text{V}$ , $V_{GS} = 0\text{V}$ )		1.0	50	$\mu\text{A}$
	Zero Gate Voltage Drain Current ( $V_{DS} = 600\text{V}$ , $V_{GS} = 0\text{V}$ , $T_J = 150^\circ\text{C}$ )			500	
$I_{GSS}$	Gate-Source Leakage Current ( $V_{GS} = \pm 20\text{V}$ , $V_{DS} = 0\text{V}$ )			$\pm 200$	nA
$V_{GS(th)}$	Gate Threshold Voltage ( $V_{DS} = V_{GS}$ , $I_D = 5.4\text{mA}$ )	2.10	3	3.9	Volts

 **CAUTION:** These Devices are Sensitive to Electrostatic Discharge. Proper Handling Procedures Should Be Followed.

Microsemi Website - <http://www.microsemi.com>

"COOLMOS™" comprise a new family of transistors developed by Infineon Technologies AG. "COOLMOS" is a trademark of Infineon Technologies AG"

# DYNAMIC CHARACTERISTICS

APT94N60L2C3

Symbol	Characteristic	Test Conditions	MIN	TYP	MAX	UNIT
$C_{iss}$	Input Capacitance	$V_{GS} = 0V$ $V_{DS} = 25V$ $f = 1\text{ MHz}$		13600		pF
$C_{oss}$	Output Capacitance			4400		
$C_{rss}$	Reverse Transfer Capacitance			290		
$Q_g$	Total Gate Charge ③	$V_{GS} = 10V$ $V_{DD} = 300V$ $I_D = 94A @ 25^\circ C$		505	640	nC
$Q_{gs}$	Gate-Source Charge			48		
$Q_{gd}$	Gate-Drain ("Miller") Charge			240		
$t_{d(on)}$	Turn-on Delay Time	<b>RESISTIVE SWITCHING</b> $V_{GS} = 13V$ $V_{DD} = 380V$ $I_D = 94A @ 125^\circ C$ $R_G = 0.9\Omega$		18		ns
$t_r$	Rise Time			27		
$t_{d(off)}$	Turn-off Delay Time			110	165	
$t_f$	Fall Time			8	12	
$E_{on}$	Turn-on Switching Energy ⑥	<b>INDUCTIVE SWITCHING @ 25^\circ C</b> $V_{DD} = 400V, V_{GS} = 15V$ $I_D = 94A, R_G = 5\Omega$		2040		$\mu J$
$E_{off}$	Turn-off Switching Energy			3515		
$E_{on}$	Turn-on Switching Energy ⑥	<b>INDUCTIVE SWITCHING @ 125^\circ C</b> $V_{DD} = 400V, V_{GS} = 15V$ $I_D = 94A, R_G = 5\Omega$		2920		
$E_{off}$	Turn-off Switching Energy			3970		

# SOURCE-DRAIN DIODE RATINGS AND CHARACTERISTICS

Symbol	Characteristic / Test Conditions	MIN	TYP	MAX	UNIT
$I_S$	Continuous Source Current (Body Diode)			94	Amps
$I_{SM}$	Pulsed Source Current ① (Body Diode)			282	
$V_{SD}$	Diode Forward Voltage ② ( $V_{GS} = 0V, I_S = -94A$ )		1	1.2	Volts
$t_{rr}$	Reverse Recovery Time ( $I_S = -94A, di_S/dt = 100A/\mu s, V_R = 350V$ )		861		ns
$Q_{rr}$	Reverse Recovery Charge ( $I_S = -94A, di_S/dt = 100A/\mu s, V_R = 350V$ )		46		$\mu C$
$dv/dt$	Peak Diode Recovery $dv/dt$ ⑤			6	V/ns

# THERMAL CHARACTERISTICS

Symbol	Characteristic	MIN	TYP	MAX	UNIT
$R_{\theta JC}$	Junction to Case			0.15	$^\circ C/W$
$R_{\theta JA}$	Junction to Ambient			62	

① Repetitive Rating: Pulse width limited by maximum junction temperature

② Pulse Test: Pulse width < 380  $\mu s$ , Duty Cycle < 2%

③ See MIL-STD-750 Method 3471

④ Starting  $T_J = +25^\circ C$ ,  $L = 36.0mH$ ,  $R_G = 25\Omega$ , Peak  $I_L = 10A$

⑤  $dv/dt$  numbers reflect the limitations of the test circuit rather than the device itself.  $I_S \leq -I_D 94A$   $di/dt \leq 700A/\mu s$   $V_R \leq V_{DSS}$   $T_J \leq 150^\circ C$

⑥  $E_{on}$  includes diode reverse recovery. See figures 18, 20.

⑦ Repetitive avalanche causes additional power losses that can be calculated as  $P_{AV} = E_{AR} * f$

Microsemi reserves the right to change, without notice, the specifications and information contained herein.

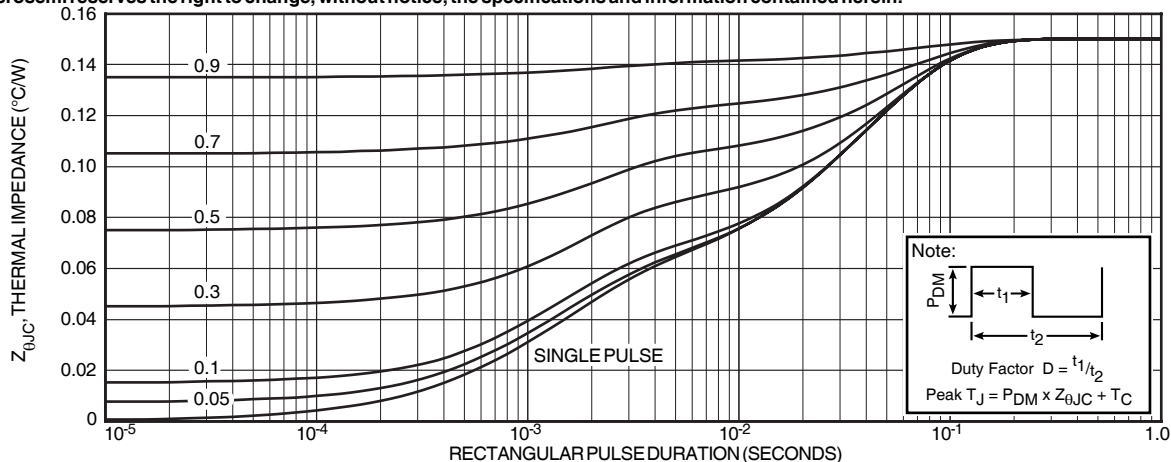

FIGURE 1, MAXIMUM EFFECTIVE TRANSIENT THERMAL IMPEDANCE, JUNCTION-TO-CASE vs PULSE DURATION

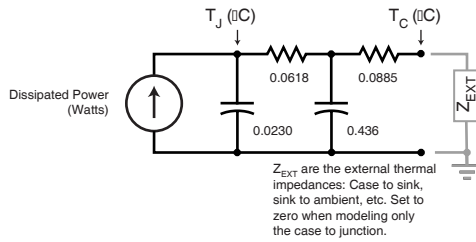

FIGURE 2, TRANSIENT THERMAL IMPEDANCE MODEL

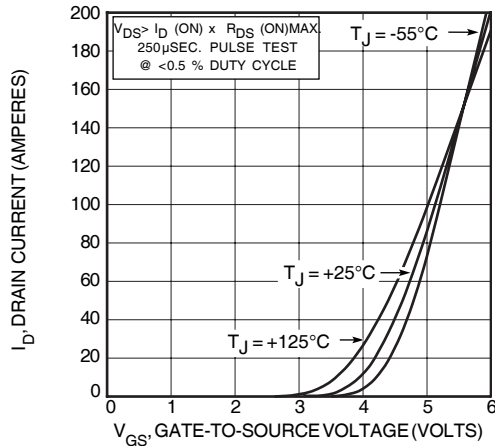

FIGURE 3, LOW VOLTAGE OUTPUT CHARACTERISTICS

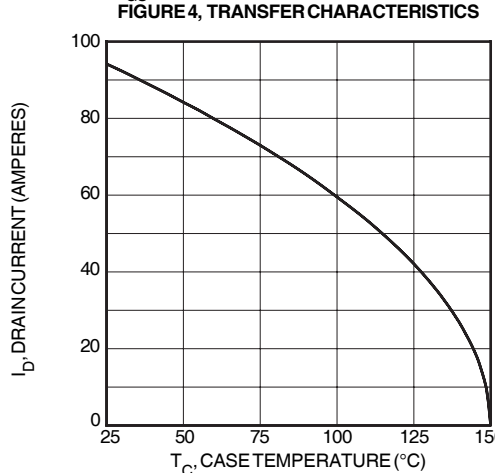

FIGURE 4, TRANSFER CHARACTERISTICS

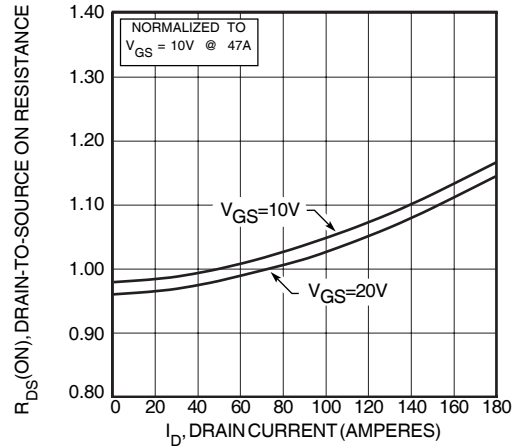

FIGURE 5,  $R_{DS(ON)}$  vs DRAIN CURRENT

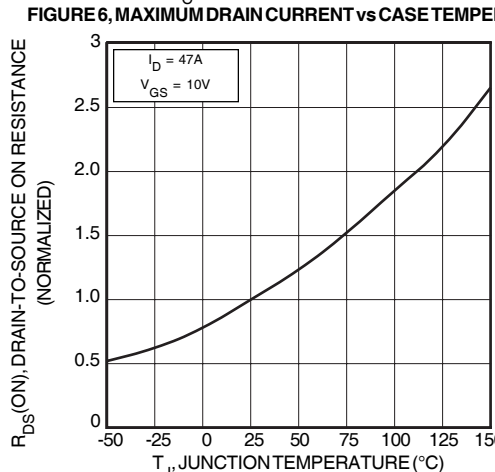

FIGURE 6, MAXIMUM DRAIN CURRENT vs CASE TEMPERATURE

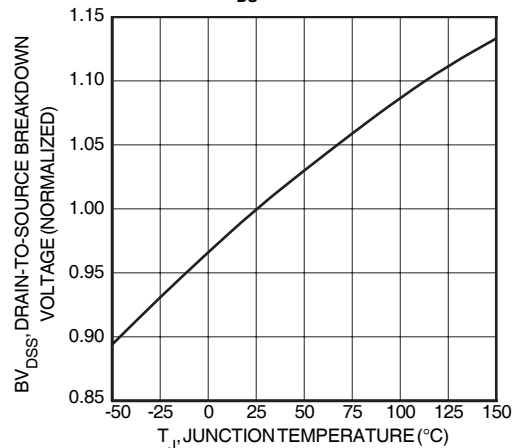

FIGURE 7, BREAKDOWN VOLTAGE vs TEMPERATURE



FIGURE 8, ON-RESISTANCE vs. TEMPERATURE

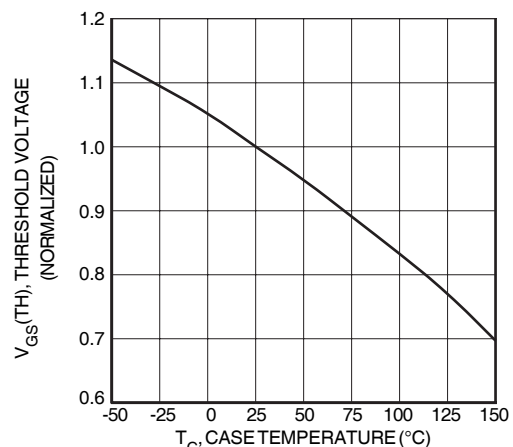
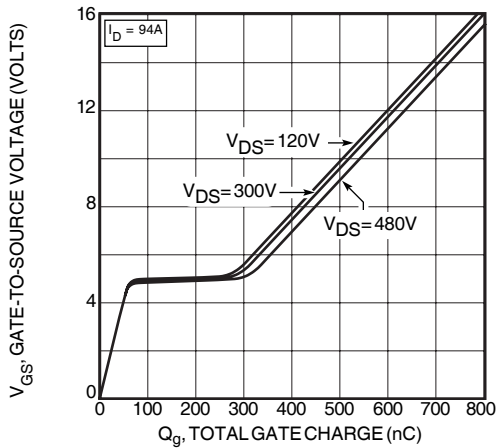

FIGURE 9, THRESHOLD VOLTAGE vs TEMPERATURE

$I_D$ , DRAIN CURRENT (AMPERES)

Graph removed

$V_{DS}$ , DRAIN-TO-SOURCE VOLTAGE (VOLTS)  
**FIGURE 10, MAXIMUM SAFE OPERATING AREA**



**FIGURE 12, GATE CHARGES vs GATE-TO-SOURCE VOLTAGE**

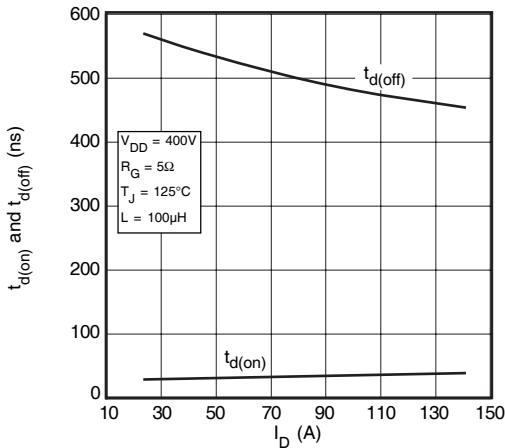

**FIGURE 14, DELAY TIMES vs CURRENT**

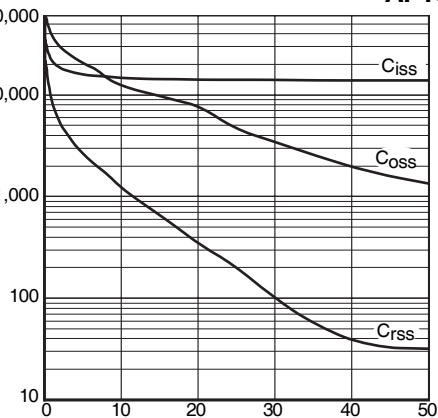
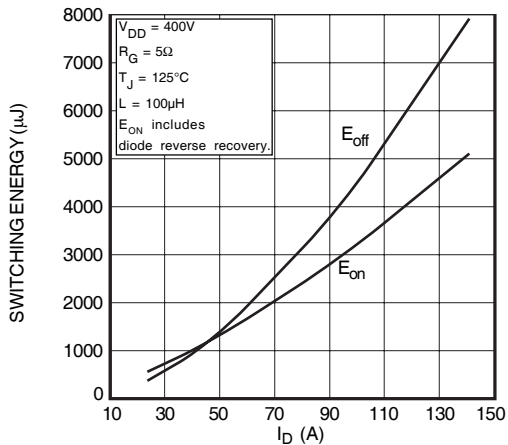

$V_{DS}$ , DRAIN-TO-SOURCE VOLTAGE (VOLTS)  
**FIGURE 11, CAPACITANCE vs DRAIN-TO-SOURCE VOLTAGE**

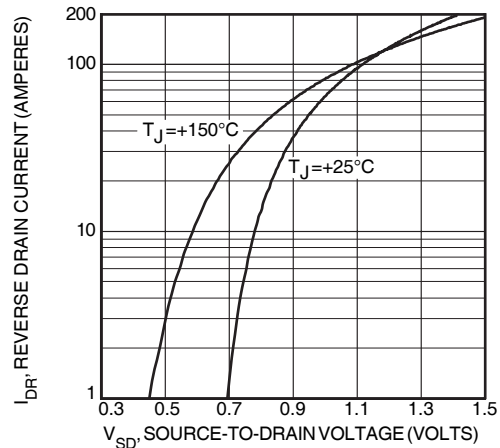

**FIGURE 13, SOURCE-DRAIN DIODE FORWARD VOLTAGE**

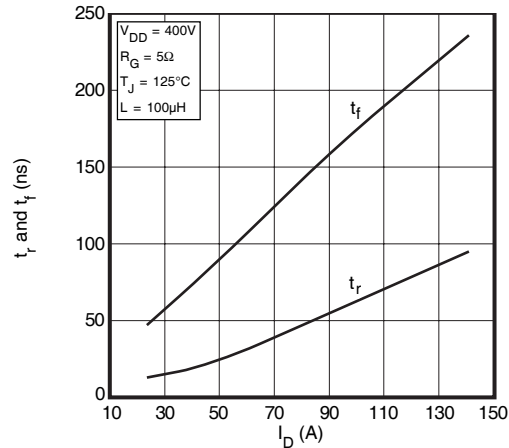

**FIGURE 15, RISE AND FALL TIMES vs CURRENT**

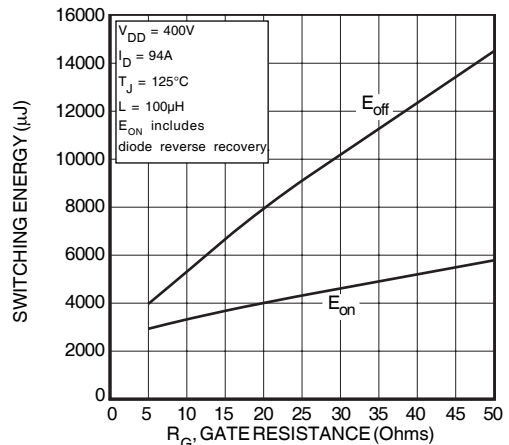

**FIGURE 16, SWITCHING ENERGY vs CURRENT**



**FIGURE 17, SWITCHING ENERGY vs. GATE RESISTANCE**



# Typical Performance Curves

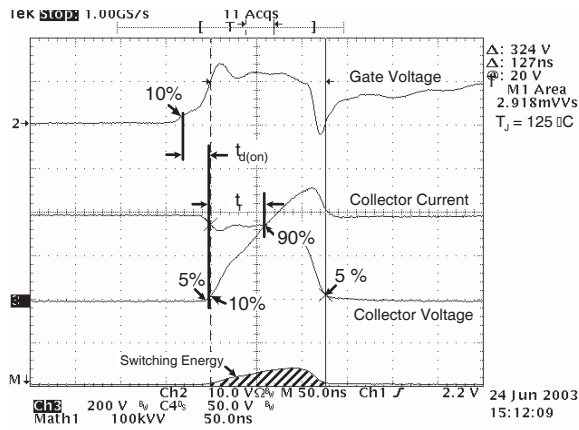

Figure 18, Turn-on Switching Waveforms and Definitions

# APT94N60L2C3

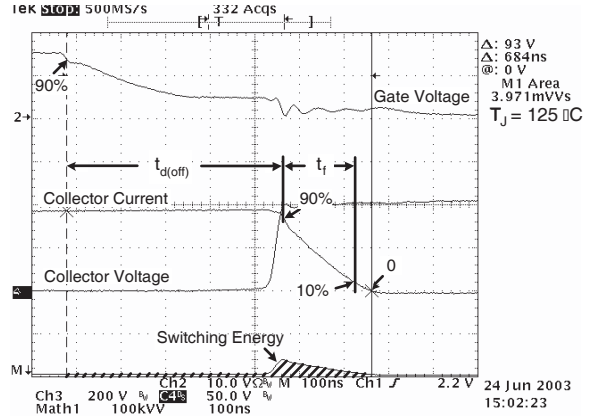

Figure 19, Turn-off Switching Waveforms and Definitions

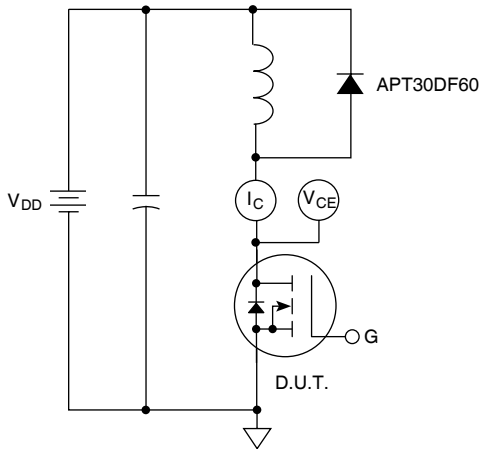
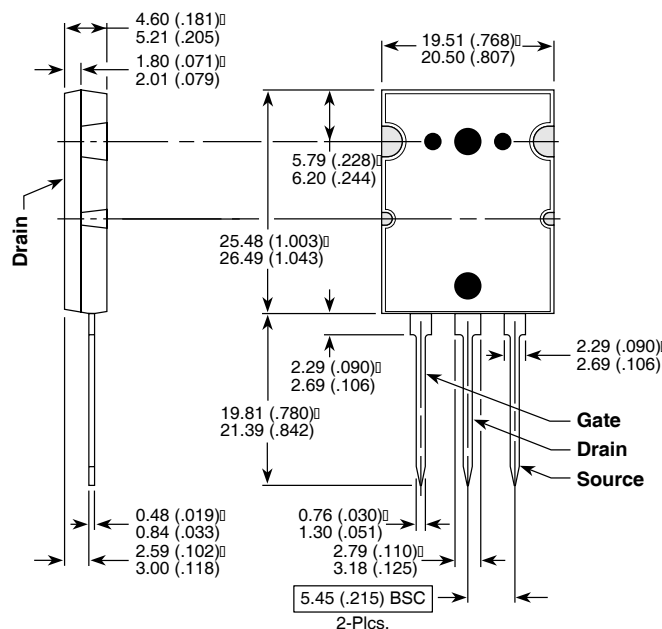

Figure 20, Inductive Switching Test Circuit

## TO-264 MAX™(L2) Package Outline



Dimensions in Millimeters and (Inches)

Microsemi's products are covered by one or more of U.S. patents 4,895,810 5,045,903 5,089,434 5,182,234 5,019,522 5,262,336 6,503,786 5,256,583 4,748,103 5,283,202 5,231,474 5,434,095 5,528,058 and foreign patents. US and Foreign patents pending. All Rights Reserved.

## Данный компонент на территории Российской Федерации

### Вы можете приобрести в компании MosChip.

Для оперативного оформления запроса Вам необходимо перейти по данной ссылке:

<http://moschip.ru/get-element>

Вы можете разместить у нас заказ для любого Вашего проекта, будь то серийное производство или разработка единичного прибора.

В нашем ассортименте представлены ведущие мировые производители активных и пассивных электронных компонентов.

Нашей специализацией является поставка электронной компонентной базы двойного назначения, продукции таких производителей как XILINX, Intel (ex.ALTERA), Vicor, Microchip, Texas Instruments, Analog Devices, Mini-Circuits, Amphenol, Glenair.

Сотрудничество с глобальными дистрибьюторами электронных компонентов, предоставляет возможность заказывать и получать с международных складов практически любой перечень компонентов в оптимальные для Вас сроки.

На всех этапах разработки и производства наши партнеры могут получить квалифицированную поддержку опытных инженеров.

Система менеджмента качества компании отвечает требованиям в соответствии с ГОСТ Р ИСО 9001, ГОСТ РВ 0015-002 и ЭС РД 009

### Офис по работе с юридическими лицами:

105318, г.Москва, ул.Щербаковская д.3, офис 1107, 1118, ДЦ «Щербаковский»

Телефон: +7 495 668-12-70 (многоканальный)

Факс: +7 495 668-12-70 (доб.304)

E-mail: [info@moschip.ru](mailto:info@moschip.ru)

Skype отдела продаж:

moschip.ru

moschip.ru\_4

moschip.ru\_6

moschip.ru\_9