

RFSW6224

Absorptive High Isolation SPDT Switch with Negative Voltage Generator Shutdown, 5MHz to 6000MHz

The RFSW6224 is a Silicon on Insulator (SOI) single-pole, double throw (SPDT) switch designed for use in cellular, 3G, LTE, and other high performance communications systems. It offers a high isolation symmetric topology with excellent linearity and power handling capability. No blocking caps are necessary on the RF ports. The design is non-reflective such that RF ports 1 and 2 are terminated in the off-state. The V_{EN} pin allows for a terminated “all-off state”. The V_{SD} pin will turn the negative voltage generator off and allow for external negative supply input on the V_{NEG} pin.



Package: QFN, 16-pin,
4.0mm x 4.0mm

Features

- 5MHz to 6000MHz Operation
- Symmetric SPDT
- Non-Reflective (RF1, RF2)
- Terminated All-off State
- No Blocking Caps Necessary Unless Voltage on RF Line
- High Isolation: 60dB at 2GHz
- High Input IP3: 66dBm
- Option to Turn Off Negative Voltage Generator and Supply V_{NEG} Externally
- 2kV ESD
- 1.8V Logic Compatible

Applications

- Cellular, 3G, LTE Infrastructure
- WiBro, WiMAX, LTE
- Wireless Backhaul
- High Performance Communications Systems
- Test Equipment

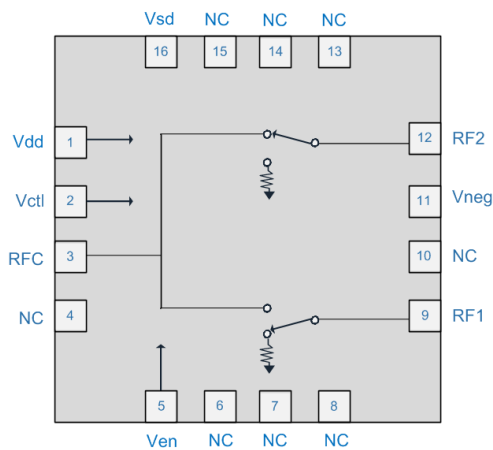

Functional Block Diagram

Ordering Information

RFSW6224SQ	Sample bag with 25 pieces
RFSW6224SR	7" Reel with 100 pieces
RFSW6224TR13	13" Reel with 2500 pieces
RFSW6224PCK-410	5MHz to 6000MHz PCBA with 5-piece sample bag

Absolute Maximum Ratings

Parameter	Rating	Unit
Control Voltage (V_{CTL} , V_{EN} , V_{SD})	6.0	V
Supply Voltage (V_{DD})	6.0	V
External Negative Supply (V_{NEG})	-6.0	V
Maximum CW Input Power	36	dBm
Storage Temperature Range	-40 to +150	°C
ESD Rating - Human Body Model (HBM)	2000	V
Moisture Sensitivity Level	MSL2	



Caution! ESD sensitive device.



RFMD Green: RoHS status based on EU Directive 2011/65/EU (at time of this document revision), halogen free per IEC 61249-2-21, < 1000ppm each of antimony trioxide in polymeric materials and red phosphorus as a flame retardant, and <2% antimony in solder.

Exceeding any one or a combination of the Absolute Maximum Rating conditions may cause permanent damage to the device. Extended application of Absolute Maximum Rating conditions to the device may reduce device reliability. Specified typical performance or functional operation of the device under Absolute Maximum Rating conditions is not implied.

Recommended Operating Condition

Parameter	Specification			Unit
	Min	Typ	Max	
Operating Temperature Range	-40		+105	°C
Operating Junction Temperature			125	°C
Supply Voltage	2.5	3	5.5	V

Nominal Operating Parameters

Parameter	Specification			Unit	Condition
	Min	Typ	Max		
General Performance^{1 & 2}					Electrical Specifications, TA = 25°C, $V_{CTRL} = 0/+5 V_{DC}$, $V_{DD} = +5V_{DC}$, 50Ω system.
Operating Frequency Range	5		6000	MHz	
Insertion Loss (RFC to RF1/RF2)		0.55		dB	0.4GHz
		0.6		dB	1GHz
		0.75	1.1	dB	2GHz
		0.9		dB	3GHz
		0.9		dB	4GHz
		1.1		dB	5GHz
Isolation (RFC to RF1/RF2)		75		dB	0.4GHz
		63		dB	1GHz
	53	60		dB	2GHz
		60		dB	3GHz
		60		dB	4GHz
		48		dB	5GHz

Parameter	Specification			Unit	Condition
	Min	Typ	Max		
General Performance - Continued					Electrical Specifications, TA = 25°C, V_{CRTL} = 0/+5 V_{DC}, V_{DD} = +5V_{DC}, 50Ω system.
Isolation (RF1 to RF2)		80		dB	0.4GHz
		70		dB	1GHz
		60		dB	2GHz
		53		dB	3GHz
		48		dB	4GHz
		49		dB	5GHz
Return Loss (RF1/RF2 On-state)		28		dB	0.4GHz
		27		dB	1GHz
		20		dB	2GHz
		20		dB	3GHz
		22		dB	4GHz
		17		dB	5GHz
Return Loss (RF1/RF2 Off-state)		37		dB	0.4GHz
		36		dB	1GHz
		30		dB	2GHz
		27		dB	3GHz
		23		dB	4GHz
		20		dB	5GHz
Input IP3		65		dBm	1GHz + 12dBm input power per tone, 1MHz tone spacing
		65		dBm	2GHz + 12dBm input power per tone, 1MHz tone spacing
Input 0.1dB Compression Point		36		dBm	1GHz
Input 1dB Compression Point		36		dBm	
Settling Time		1.5		μs	Internal NVG on, 50% control to optimum functionality
		40		μs	Internal NVG off, external V _{NEG} supplied, 50% control to optimum functionality
Switching Speed		250		ns	50% control to 10/90% RF
NVG Spurs		-95		dBm	Internal NVG on
Power Supply					
Supply Current (I _{DD})		140	200	μA	V _{DD} = 5.0V
Negative Supply (V _{NEG})	-5.5	-5	-3	V	Only for V _{SD} = high, otherwise leave this pin open
Control Current (I _{CTL} , I _{EN})		0.5	5	μA	V _{CTL} = 5.0V
Low Control Voltage (V _{CTL})	0		0.63	V	1.8V Logic compatible

Parameter	Specification			Unit	Condition
	Min	Typ	Max		
Power Supply - Continued					
High Control Voltage (V _{CTL})	1.1		VDD	V	

Notes:

1. S-parameters have the PCB de-embedded
2. RF ports need to be at 0V DC. If voltage is present on RF lines, blocking caps are required.

Maximum Operating Power at 85°C, CW, >300MHz

Input	State	VEN	Power	Theta-J (°C/W)
RFC, RF1/2	On	Low	33dBm ¹	97 ²
RFC	Both Off	High	31.3dBm	N/A
RF1/2	Off	Low or High	26dBm	100
RF1/2 (Simultaneous)	Both Off	High	27.8dBm ³	65

Notes:

1. Assuming load VSWR <3:1, for high VSWR loads, this value reduces to 30.5dBm
2. Applies to resistive loss from insertion loss not including mismatch loss
3. Total power in both loads being driving simultaneously
4. For <300MHz, it is recommended to operate at least 4dB below 1dB compression point

Truth Tables

Control Input		Signal Path State	
V _{CTL}	VEN	RFC-RF1	RFC-RF2
0	0	Off	On
1	0	On	Off
0	1	Off	Off
1	1	Off	Off

V _{SD}	V _{NEG}	Mode
0	Open	Internal negative voltage generation
1	-3 to -5.5	External negative voltage supplied

"0" = 0V to 0.63V

"1" = 1.1V to V_{DD}

V_{DD} = 2.5 to 5.5V, must be applied for all valid states

Turn on sequence for external V_{NEG} operation

Turn on V_{DD}, then allow 50μsec before turning on control lines and V_{NEG}.

Typical Performance: T = 25°C, V_{DD} = 3V unless otherwise noted

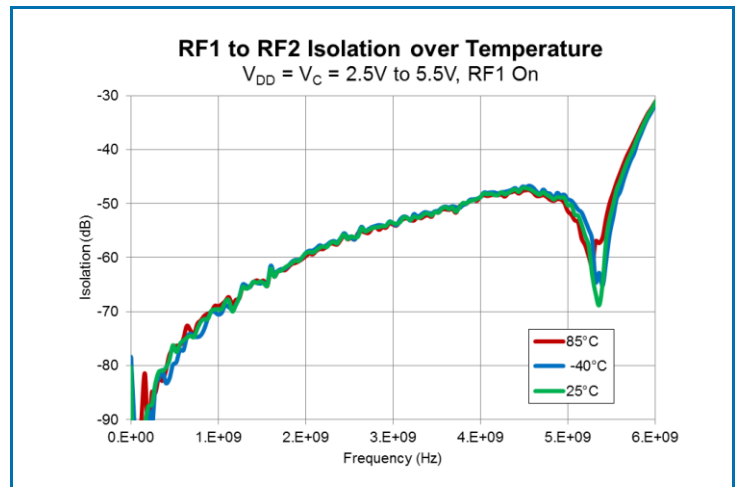
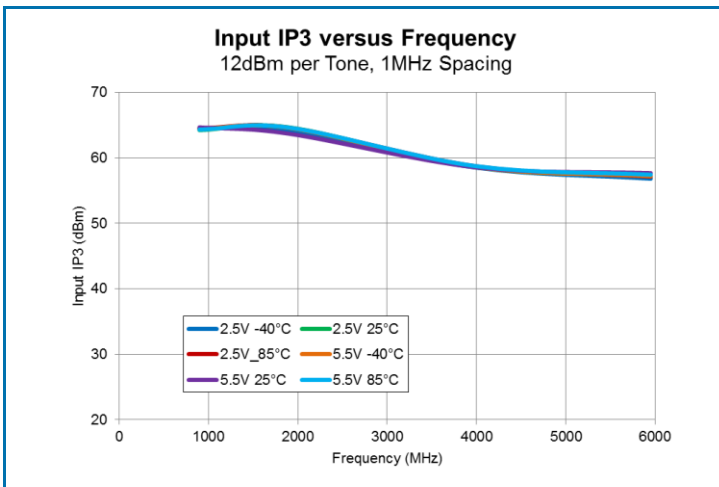
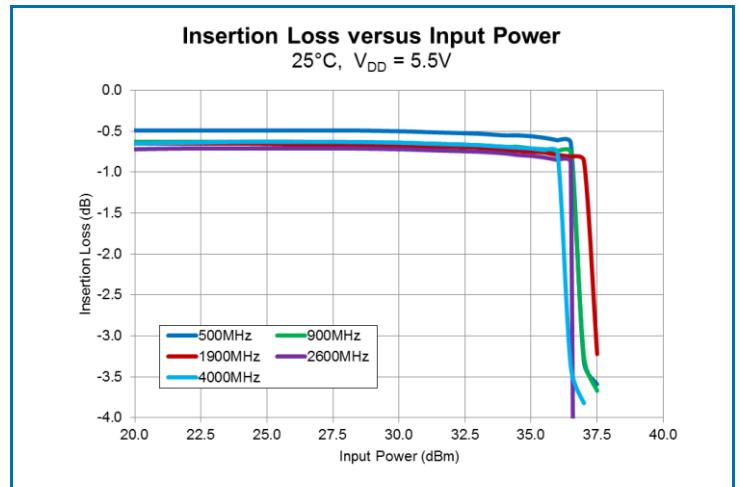
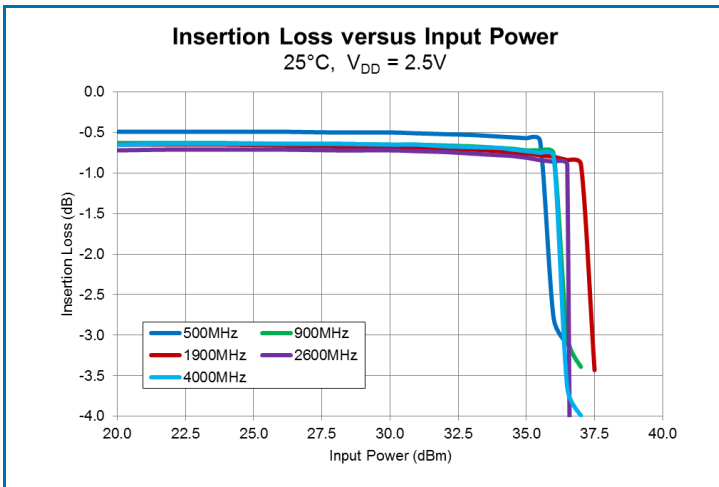
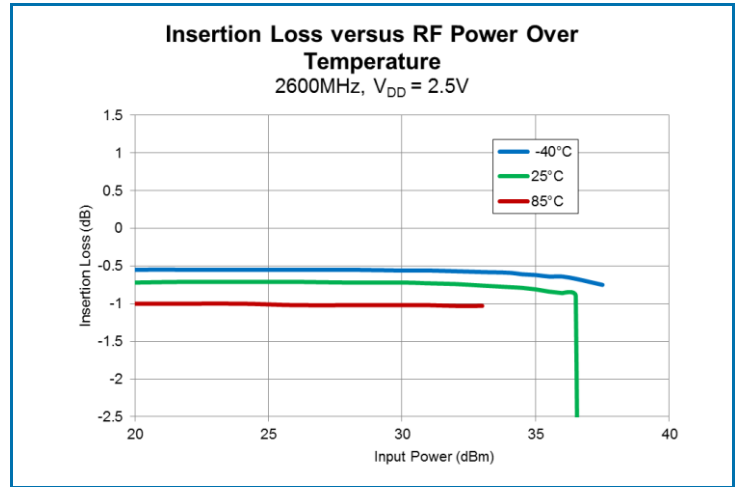
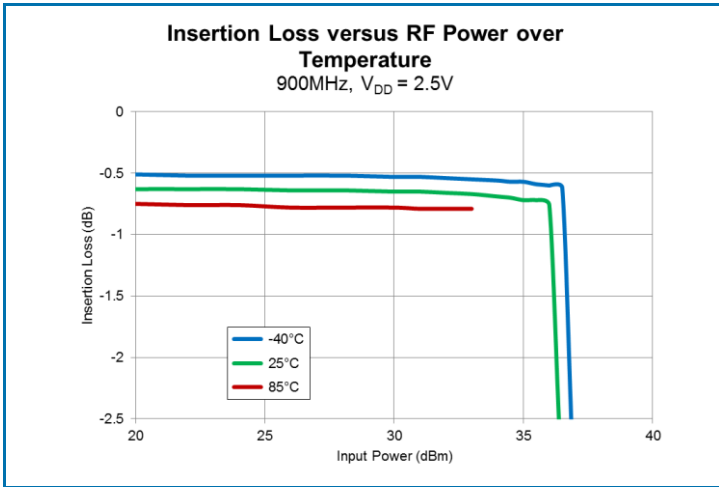

Typical Performance: T = 25°C, V_{DD} = 3V unless otherwise noted

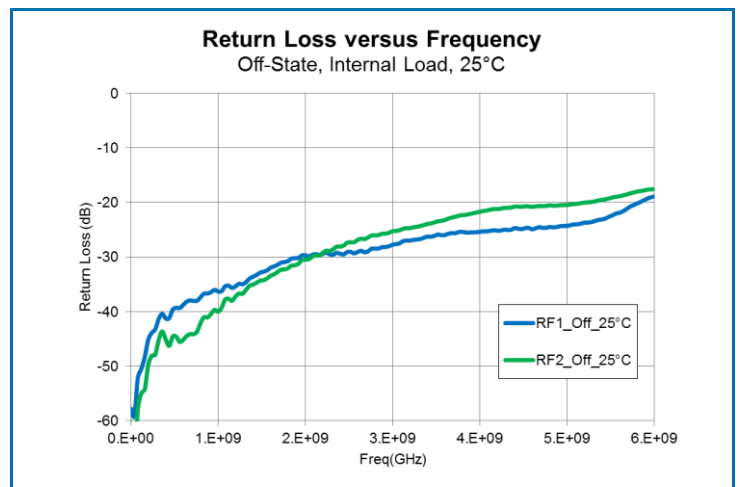
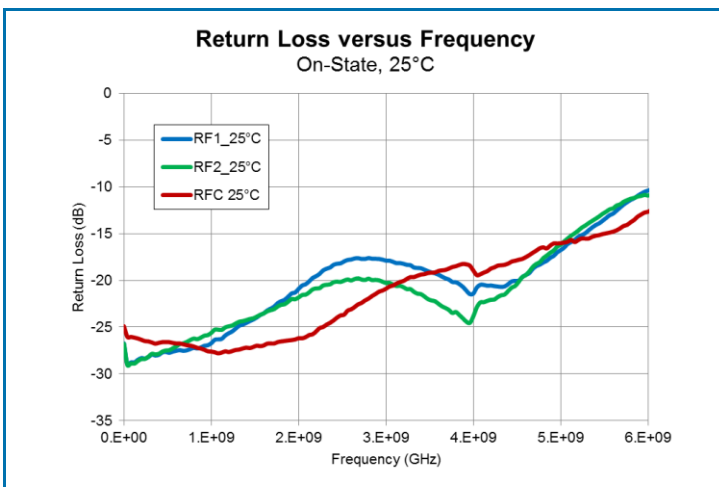
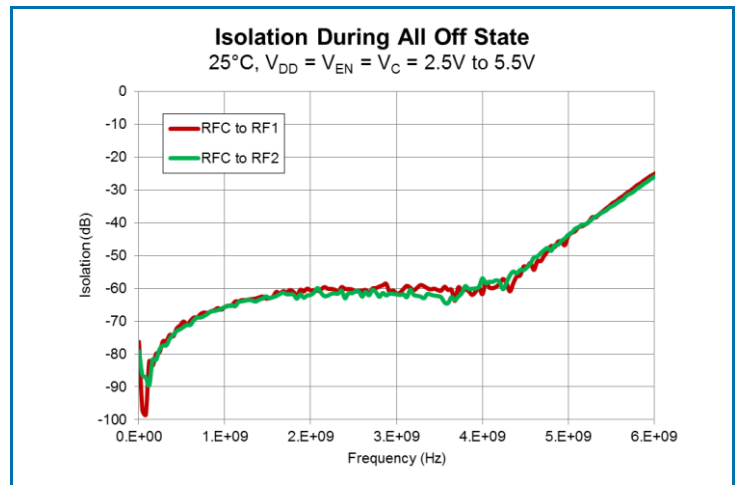
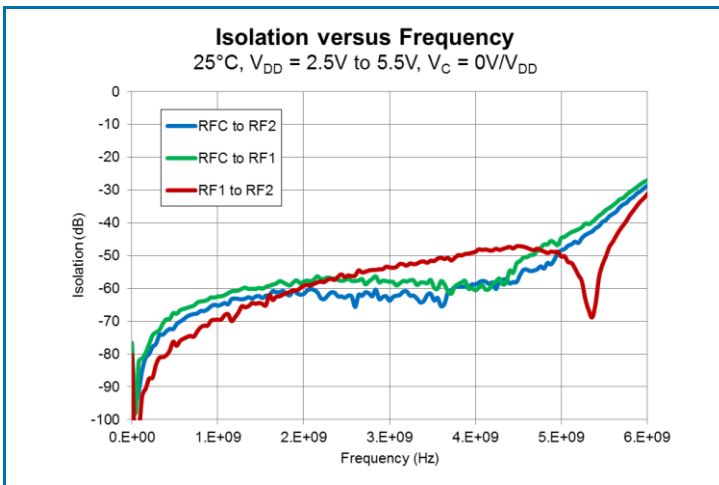
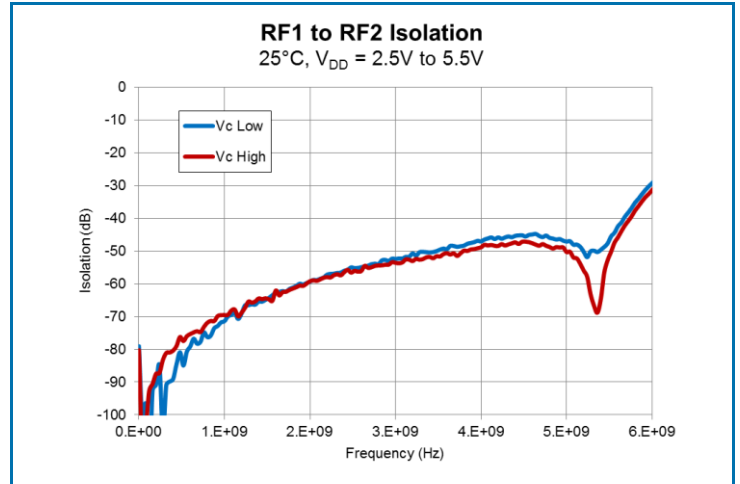
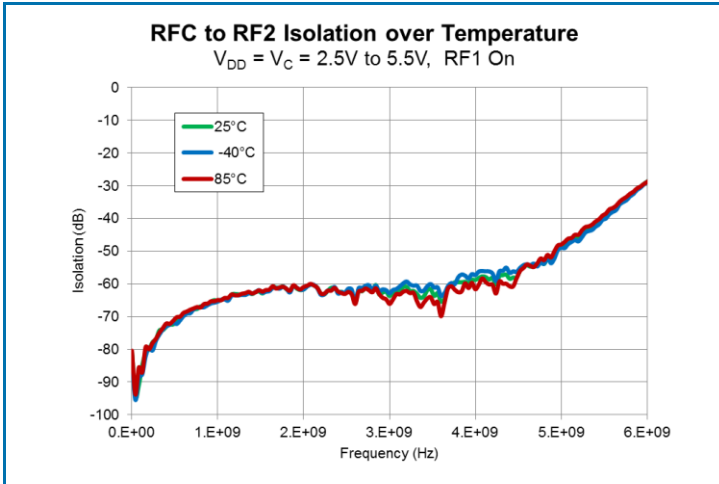

Typical Performance: T = 25°C, V_{DD} = 3V unless otherwise noted

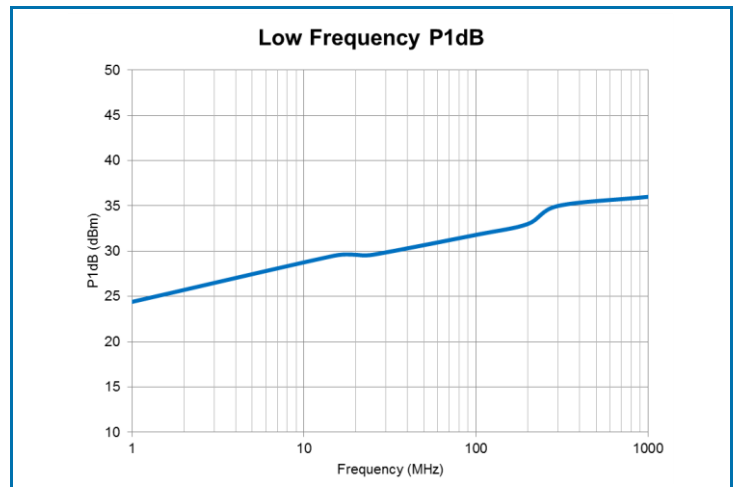
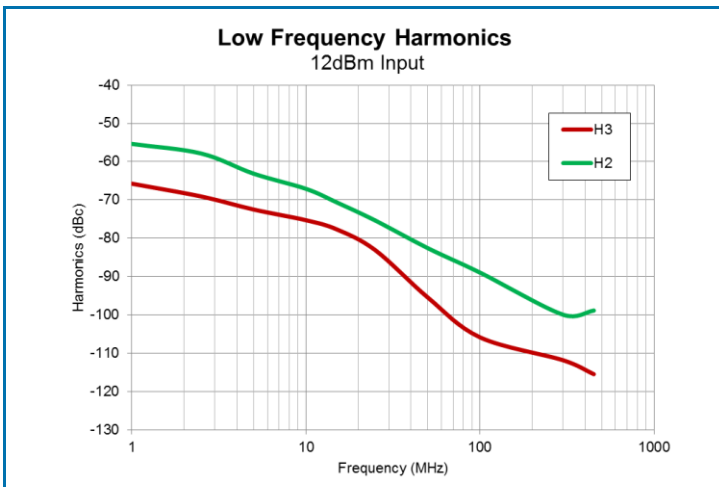
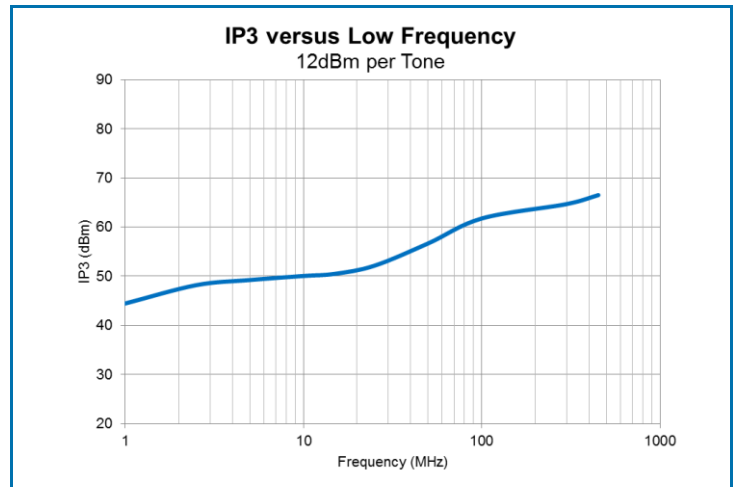
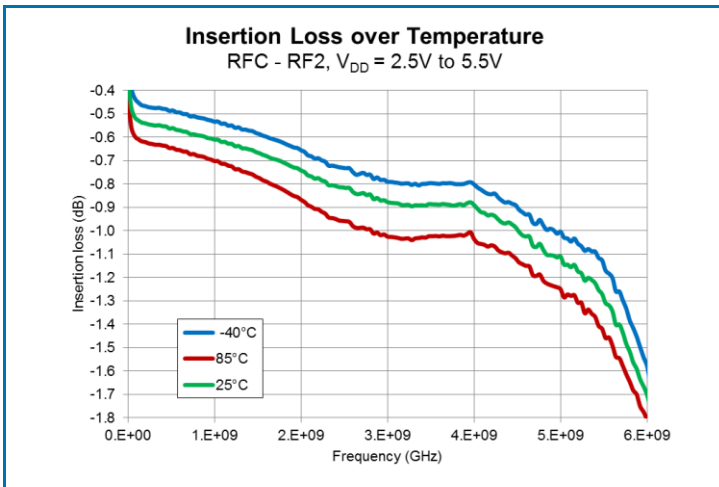
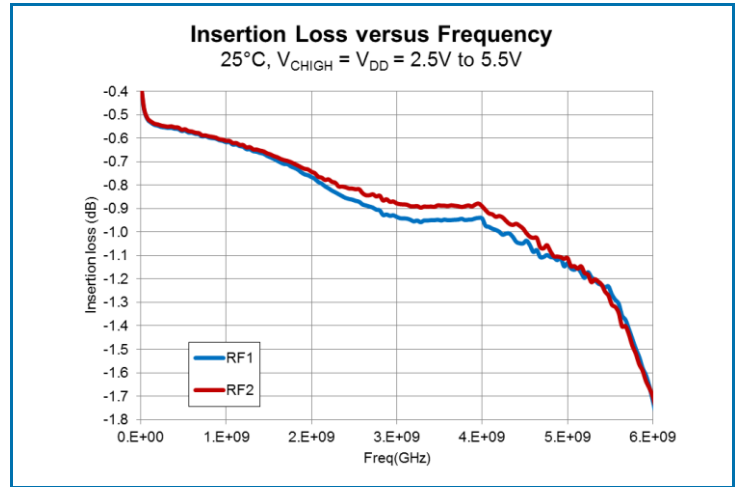
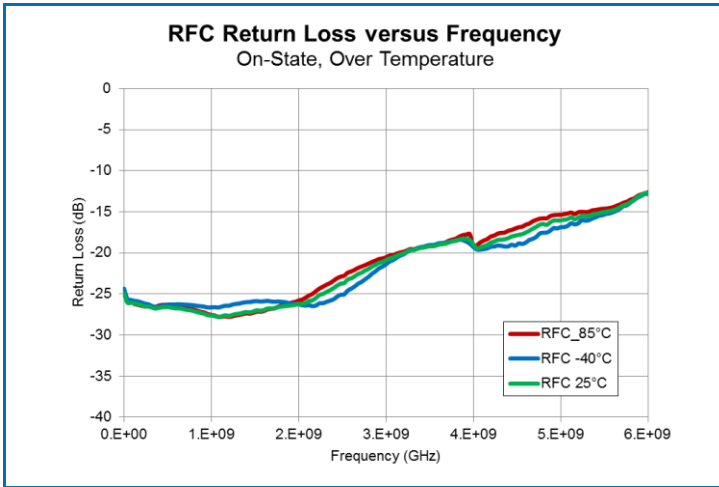

Temp = 85°C, Switching Speed (t_{OFF}) = 234ns, 50% CTL to 10%RF

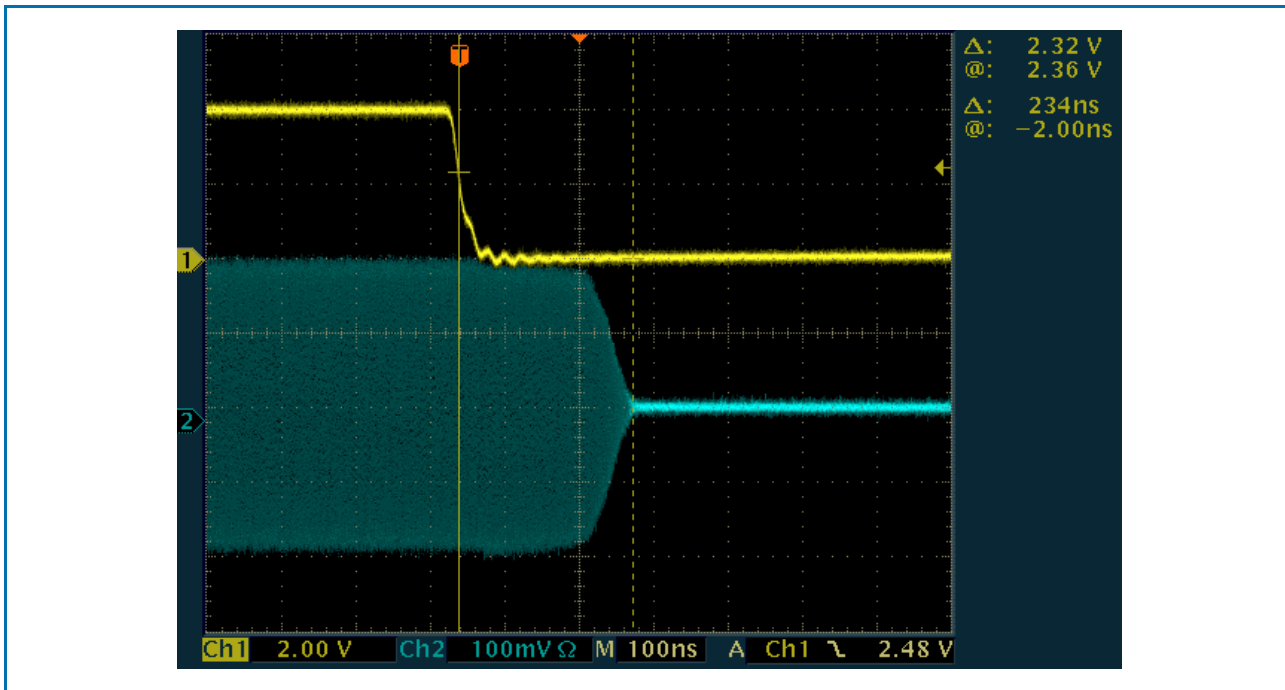

Temp = 85°C, Switching Speed (t_{ON}) = 284ns, 50% CTL to 90%RF

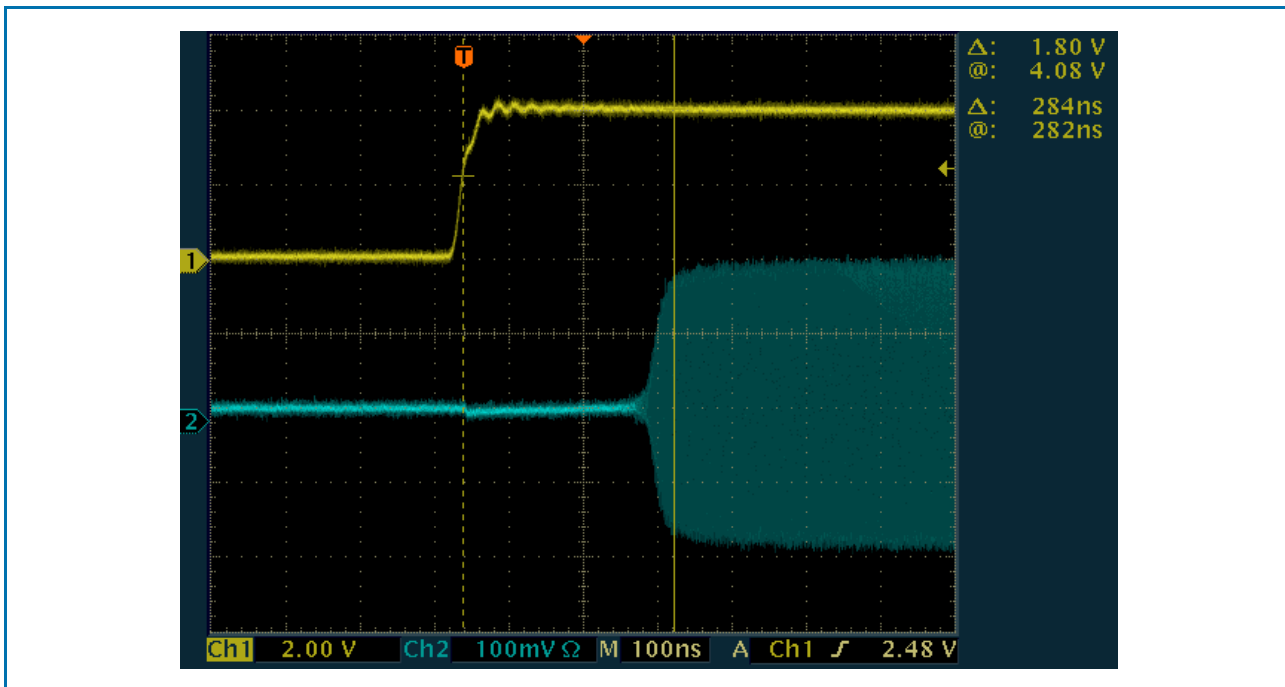

Temp = 25°C, Switching Speed (t_{OFF}) = 218ns, 50% CTL to 10%RF

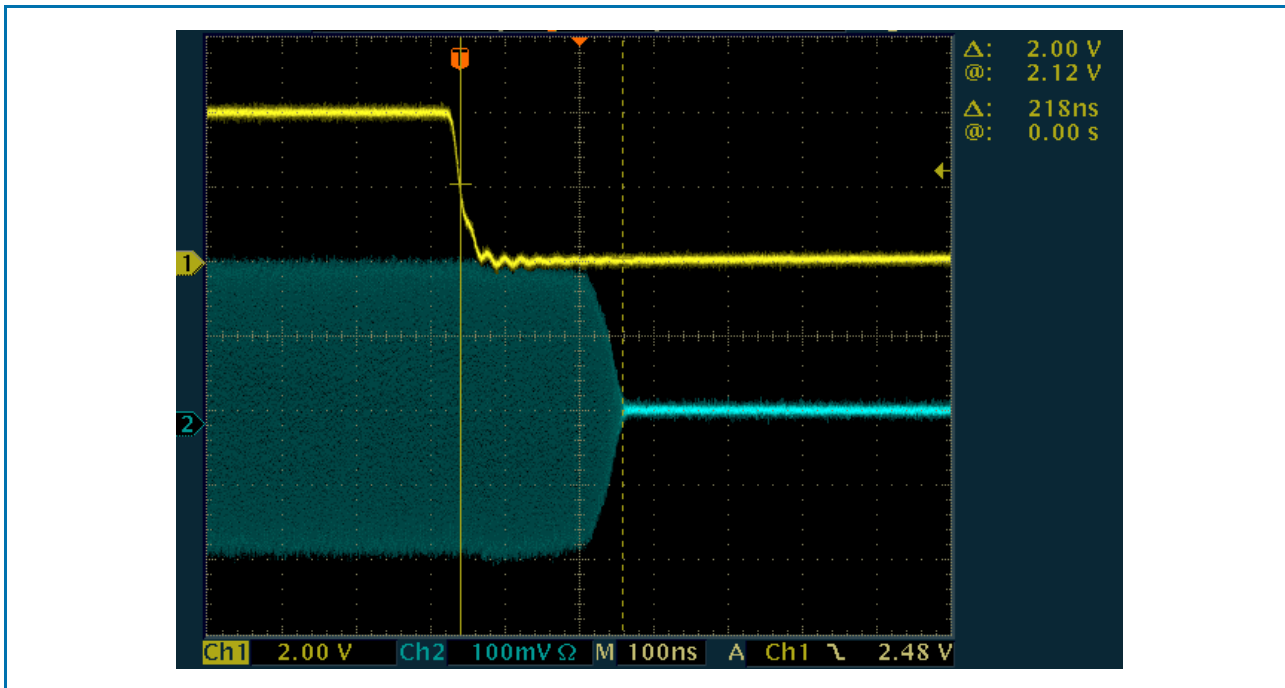

Temp = 25°C, Switching Speed (t_{ON}) = 286ns, 50% CTL to 90%RF

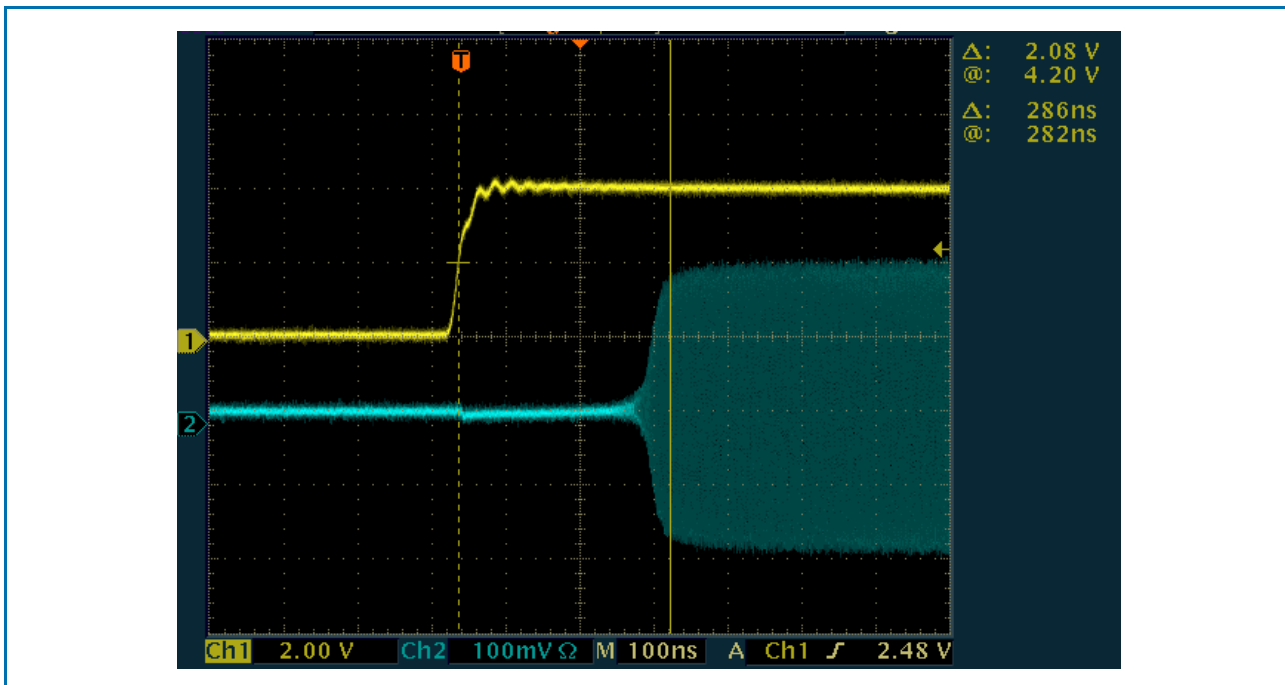

Temp = -40°C, Switching Speed (t_{OFF}) = 212ns, 50% CTL to 10%RF

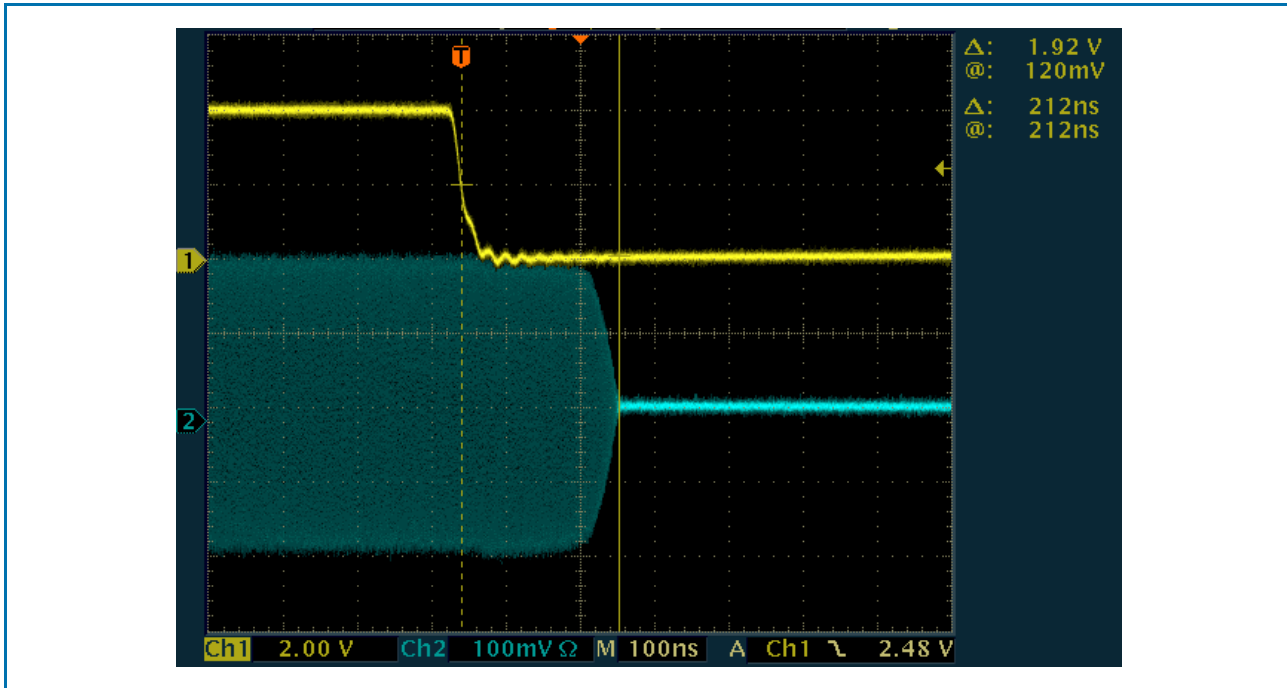

Temp = -40°C, Switching Speed (t_{ON}) = 280ns, 50% CTL to 90%RF

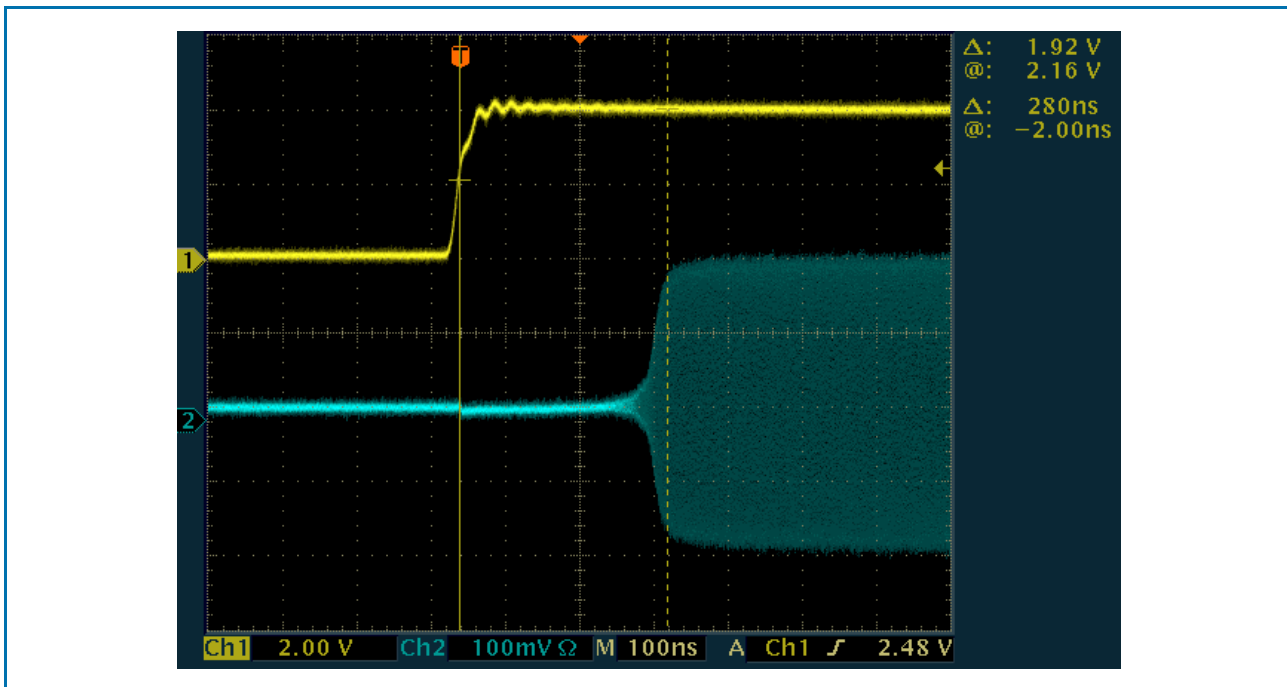

Evaluation Board Schematic

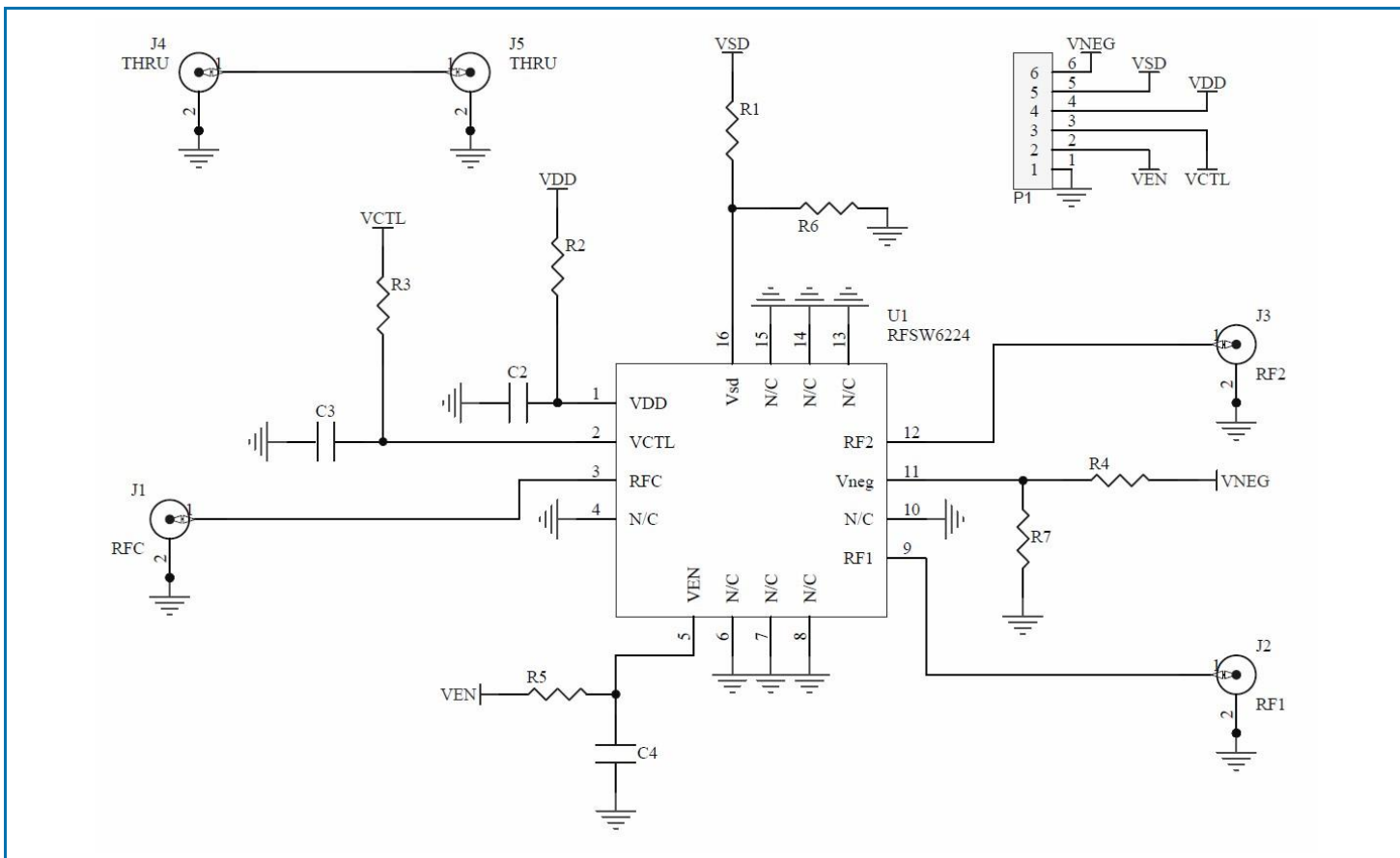

Evaluation Board Bill of Materials (BOM)

Description	Reference Designator	Manufacturer	Manufacturer's P/N
RFSW6224 Evaluation Board		Viasystems Sales, Inc. (Toronto)	RFSW6224-410(1)
CAP, 100pF, 5%, 50V, C0G, 0402 (optional)	C2-C4	Taiyo Yuden (USA), Inc.	RM UMK105 CG101JV-F
0Ω, 50mΩ MAX, 0402 LEAD FREE	R1-R5	KOA Speer Electronics, Inc.	RK73Z1ETTP
Do Not Install	R6-R7		
CONN, HDR, ST, PLRZD, 6-PIN, 0.100"	P1	AMP	640454-6
CONN, SMA, EL MINI FLT 0.068" SPE-000303	J1-J5	Aliner Industries, Inc.	20-001CF-T
RFSW6224SB	U1	RFMD	RFSW6224

Evaluation Board Assembly Drawing

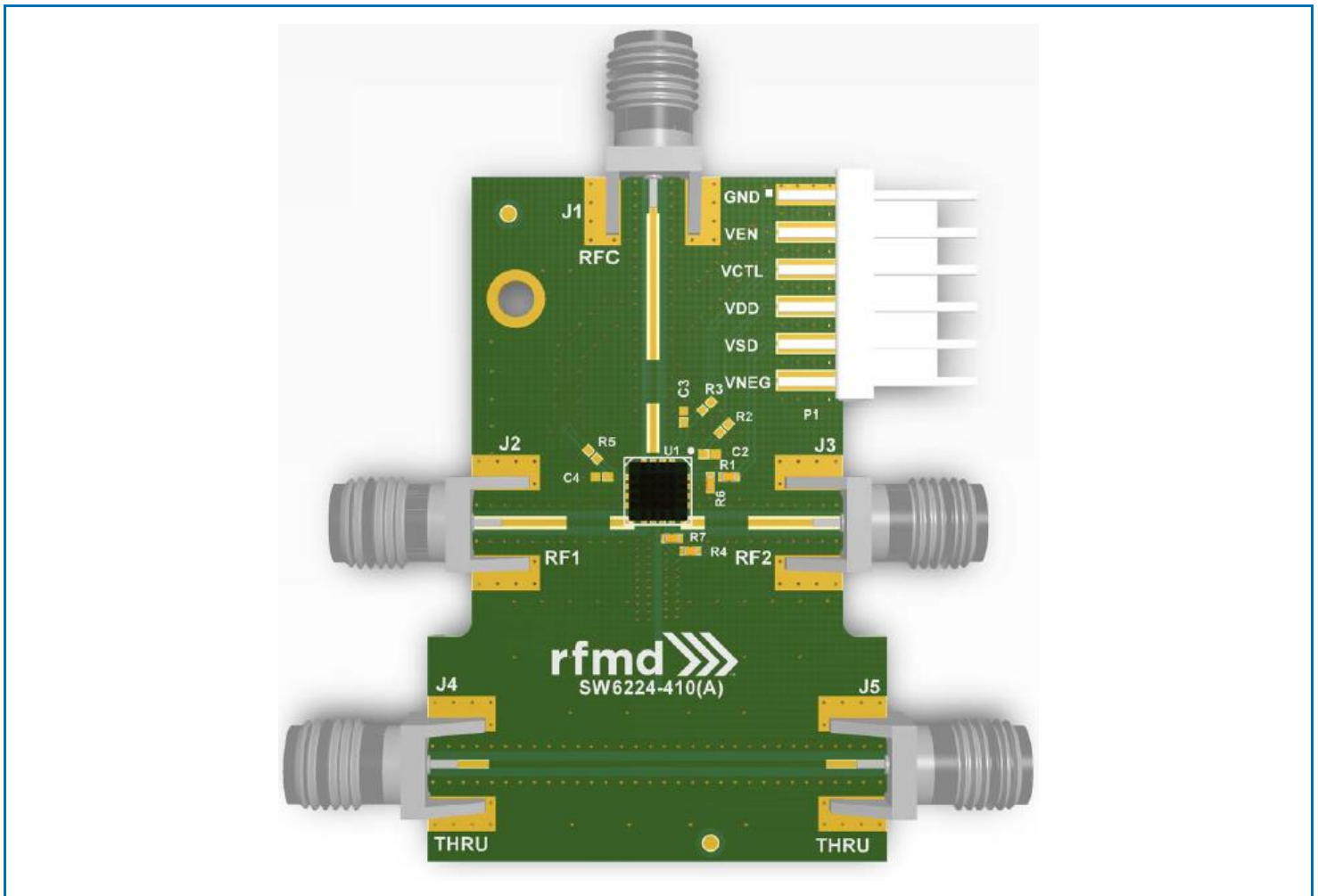

Application Schematic

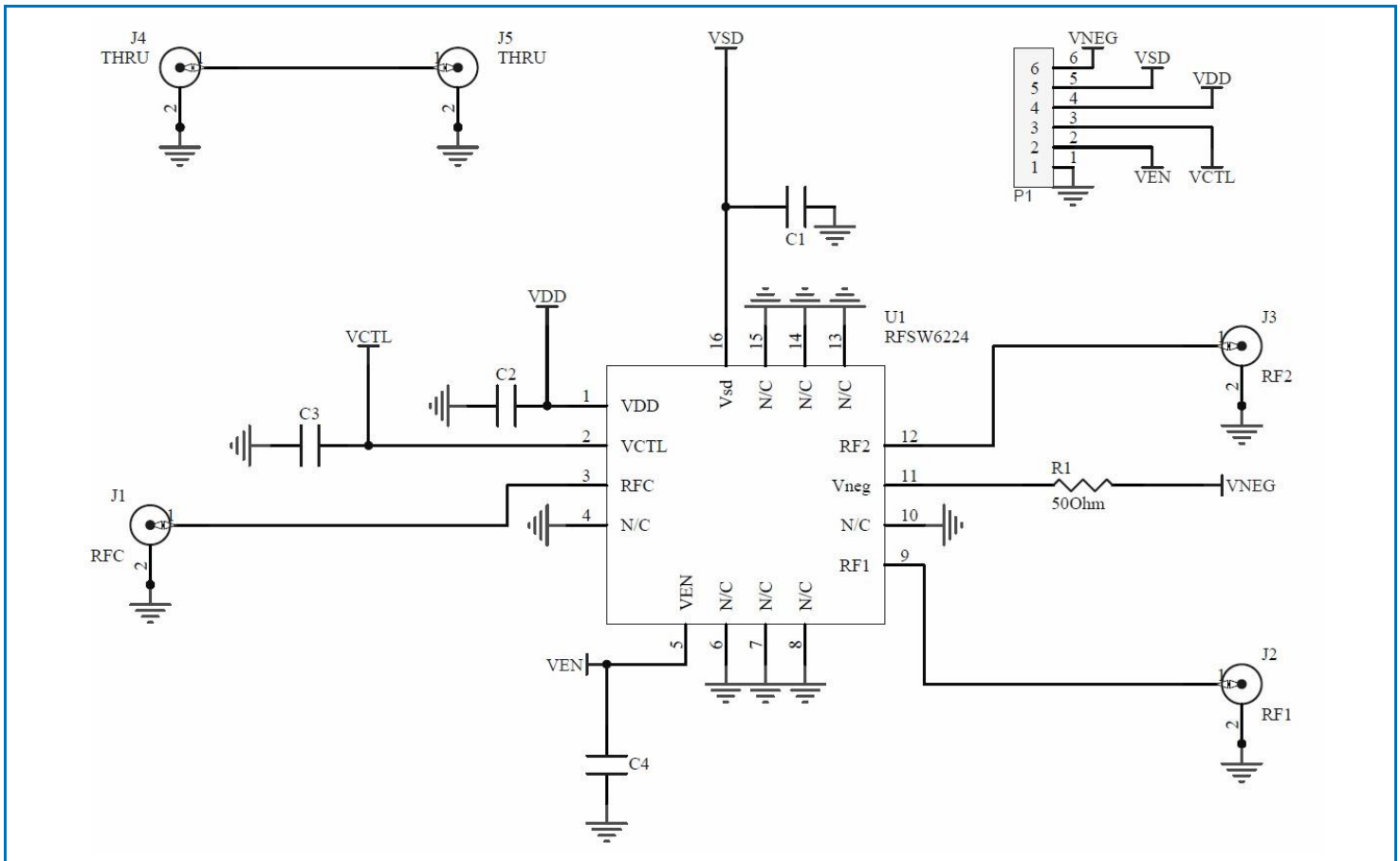

Note: RFSW6224 has internal filtering. Caps only required for excessively noisy conditions

Pin Names and Descriptions

Pin	Name	Description
1	VDD	Supply Voltage
2	VCTL	Logic Control Input
3	RFC	RF Common Port
4	NC	Grounding this pin is recommended for performance
5	VEN	Logic input for putting switch in "all-off state". Logic high for "all-off state".
6	NC	Grounding this pin is recommended for performance
7	NC	Grounding this pin is recommended for performance
8	NC	Grounding this pin is recommended for performance
9	RF1	RF Port 1
10	NC	Grounding this pin is recommended for performance
11	VNEG	External Negative Supply Voltage Input -3V to -5.5V. Leave open for on chip negative voltage generator. When using external supply, apply negative voltage at least 50 μ s after V _{DD} is applied. 50 Ω series resistance is recommended.
12	RF2	RF Port 2
13	NC	Grounding this pin is recommended for performance
14	NC	Grounding this pin is recommended for performance
15	NC	Grounding this pin is recommended for performance
16	VSD	Negative Voltage Generator Shutdown; Apply 0V for on chip negative voltage generator. Pull high for external negative supply operation.
EPAD	GND	RF and DC Ground: Must be soldered to EVB ground plane over a bed of vias

Note: RFMD recommends that the NC pins be grounded on the EVB to maximize isolation.

Package Outline (Dimensions in millimeters)

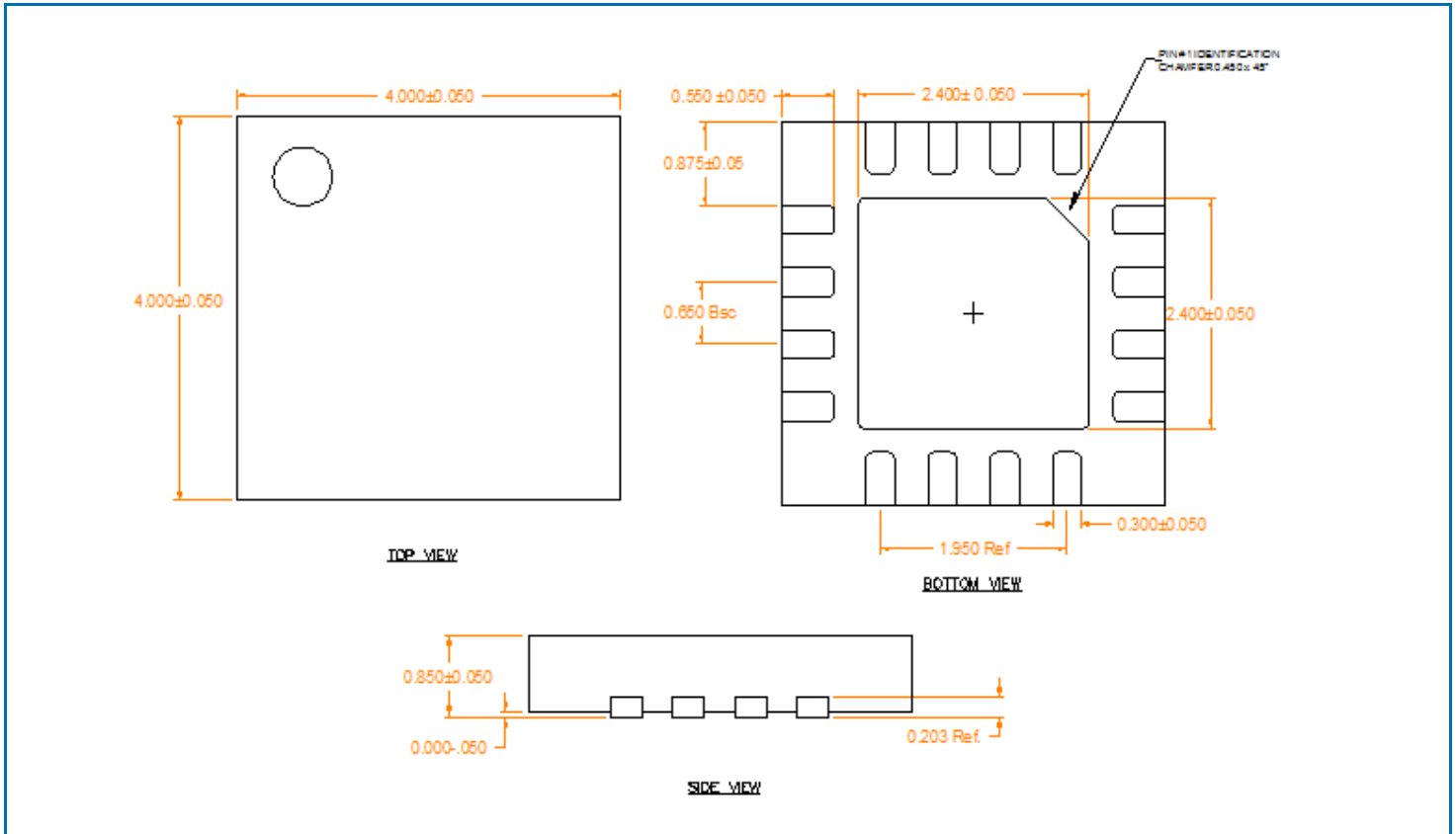

Данный компонент на территории Российской Федерации

Вы можете приобрести в компании MosChip.

Для оперативного оформления запроса Вам необходимо перейти по данной ссылке:

<http://moschip.ru/get-element>

Вы можете разместить у нас заказ для любого Вашего проекта, будь то серийное производство или разработка единичного прибора.

В нашем ассортименте представлены ведущие мировые производители активных и пассивных электронных компонентов.

Нашей специализацией является поставка электронной компонентной базы двойного назначения, продукции таких производителей как XILINX, Intel (ex.ALTERA), Vicor, Microchip, Texas Instruments, Analog Devices, Mini-Circuits, Amphenol, Glenair.

Сотрудничество с глобальными дистрибьюторами электронных компонентов, предоставляет возможность заказывать и получать с международных складов практически любой перечень компонентов в оптимальные для Вас сроки.

На всех этапах разработки и производства наши партнеры могут получить квалифицированную поддержку опытных инженеров.

Система менеджмента качества компании отвечает требованиям в соответствии с ГОСТ Р ИСО 9001, ГОСТ РВ 0015-002 и ЭС РД 009

Офис по работе с юридическими лицами:

105318, г.Москва, ул.Щербаковская д.3, офис 1107, 1118, ДЦ «Щербаковский»

Телефон: +7 495 668-12-70 (многоканальный)

Факс: +7 495 668-12-70 (доб.304)

E-mail: info@moschip.ru

Skype отдела продаж:

moschip.ru

moschip.ru_4

moschip.ru_6

moschip.ru_9