

Notice for TAIYO YUDEN products

Please read this notice before using the TAIYO YUDEN products.

REMINDERS

- Product information in this catalog is as of October 2013. All of the contents specified herein are subject to change without notice due to technical improvements, etc. Therefore, please check for the latest information carefully before practical application or usage of the Products.

Please note that TAIYO YUDEN CO., LTD. shall not be responsible for any defects in products or equipment incorporating such products, which are caused under the conditions other than those specified in this catalog or individual specification.

- Please contact TAIYO YUDEN CO., LTD. for further details of product specifications as the individual specification is available.

- Please conduct validation and verification of products in actual condition of mounting and operating environment before commercial shipment of the equipment.

- All electronic components or functional modules listed in this catalog are developed, designed and intended for use in general electronics equipment.(for AV, office automation, household, office supply, information service, telecommunications, (such as mobile phone or PC) etc.). Before incorporating the components or devices into any equipment in the field such as transportation,(automotive control, train control, ship control), transportation signal, disaster prevention, medical, public information network (telephone exchange, base station) etc. which may have direct influence to harm or injure a human body, please contact TAIYO YUDEN CO., LTD. for more detail in advance.

Do not incorporate the products into any equipment in fields such as aerospace, aviation, nuclear control, submarine system, military, etc. where higher safety and reliability are especially required.

In addition, even electronic components or functional modules that are used for the general electronic equipment, if the equipment or the electric circuit require high safety or reliability function or performances, a sufficient reliability evaluation check for safety shall be performed before commercial shipment and moreover, due consideration to install a protective circuit is strongly recommended at customer's design stage.

- The contents of this catalog are applicable to the products which are purchased from our sales offices or distributors (so called "TAIYO YUDEN' s official sales channel").

It is only applicable to the products purchased from any of TAIYO YUDEN' s official sales channel.

- Please note that TAIYO YUDEN CO., LTD. shall have no responsibility for any controversies or disputes that may occur in connection with a third party's intellectual property rights and other related rights arising from your usage of products in this catalog. TAIYO YUDEN CO., LTD. grants no license for such rights.

- Caution for export

Certain items in this catalog may require specific procedures for export according to "Foreign Exchange and Foreign Trade Control Law" of Japan, "U.S. Export Administration Regulations", and other applicable regulations. Should you have any question or inquiry on this matter, please contact our sales staff.

CHIP BEAD INDUCTORS FOR POWER LINES (FB SERIES M TYPE)



WAVE REFLOW

PARTS NUMBER

*Operating Temp. : -40~+125°C (Including self-generated heat)

F	B	△	M	J	3	2	1	6	H	S	8	0	0	-	T	△
①	②	③	④	⑤	⑥	⑦	⑧	⑨								

△=Blank space

① Series name

Code	Series name
FB	Ferrite bead

② Shape

Code	Shape
M	Rectangular chip

③ Characteristics

Code	Characteristics
J	Standard
H	High Impedance type

④ Dimensions (L × W)

Code	Type (inch)	Dimensions (L × W) [mm]
1608	1608(0603)	1.6 × 0.8
2125	2125(0805)	2.0 × 1.25
2012	2012(0805)	
2016	2016(0806)	2.0 × 1.6
3216	3216(1206)	3.2 × 1.6
3225	3225(1210)	3.2 × 2.5
4516	4516(1806)	4.5 × 1.6
4525	4525(1810)	4.5 × 2.5
4532	4532(1812)	4.5 × 3.2

⑤ Material

Code	Material
HS	Refer to impedance curves for material differences
HM	
HL	

⑥ Nominal impedance

Code (example)	Nominal impedance [Ω]
330	33
111	110
132	1300

⑦ Impedance tolerance

Code	Impedance tolerance
-	±25%
N	±30%

⑧ Packaging

Code	Packaging
T	Taping

⑨ Internal code

Code	Internal code
△	Standard

STANDARD EXTERNAL DIMENSIONS / STANDARD QUANTITY

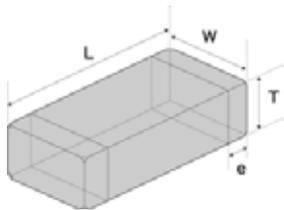

Recommended Land Patterns Surface Mounting

*Mounting and soldering conditions should be checked beforehand.

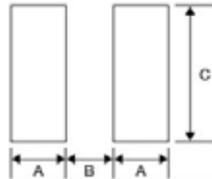

Type	A	B	C
FB MJ1608	1.0	1.0	1.0
FB MJ2125	1.4	1.2	1.65
FB MJ3216	1.4	2.2	2.0
FB MJ4516	1.75	3.5	2.0
FB MH1608	1.0	1.0	1.0
FB MH2012	1.4	1.2	1.65
FB MH2016	1.4	1.2	2.0
FB MH3216	1.4	2.2	2.0
FB MH3225	1.4	2.2	2.9
FB MH4516	1.75	3.5	2.0
FB MH4525	1.75	3.5	2.9
FB MH4532	1.75	3.5	3.7

Unit: mm

Type	L	W	T	e	Standard quantity [pcs]	
					Paper tape	Embossed tape
FB MJ1608 (0603)	1.6±0.2 (0.063±0.008)	0.8±0.2 (0.031±0.008)	0.8±0.2 (0.031±0.008)	0.3±0.2 (0.012±0.008)	4000	-
FB MJ2125 (0805)	2.0±0.2 (0.079±0.008)	1.25±0.2 (0.049±0.008)	0.85±0.2 (0.033±0.008)	0.5±0.3 (0.020±0.012)	4000	-
FB MJ3216 (1206)	3.2±0.3 (0.126±0.012)	1.6±0.2 (0.063±0.008)	1.1±0.2 (0.043±0.008)	0.5±0.3 (0.020±0.012)	-	2000
FB MJ4516 (1806)	4.5±0.3 (0.177±0.012)	1.6±0.2 (0.063±0.008)	1.1±0.2 (0.043±0.008)	0.5±0.3 (0.020±0.012)	-	2000
FB MH1608 (0603)	1.6±0.1 (0.063±0.004)	0.8±0.1 (0.031±0.004)	0.8±0.1 (0.031±0.004)	0.3±0.15 (0.012±0.006)	4000	-
FB MH2012 (0805)	2.0±0.2 (0.079±0.008)	1.25±0.2 (0.049±0.008)	0.85±0.2 (0.033±0.008)	0.5±0.3 (0.020±0.012)	4000	-
FB MH2016 (0806)	2.0±0.2 (0.079±0.008)	1.6±0.2 (0.063±0.008)	1.6±0.2 (0.063±0.008)	0.5±0.3 (0.020±0.012)	-	2000
FB MH3216 (1206)	3.2±0.3 (0.126±0.012)	1.6±0.2 (0.063±0.008)	1.6±0.2 (0.063±0.008)	0.5±0.3 (0.020±0.012)	-	2000
FB MH3225 (1210)	3.2±0.3 (0.126±0.012)	2.5±0.3 (0.098±0.012)	2.5±0.3 (0.098±0.012)	0.5±0.3 (0.020±0.012)	-	1000
FB MH4516 (1806)	4.5±0.3 (0.177±0.012)	1.6±0.2 (0.063±0.008)	1.6±0.2 (0.063±0.008)	0.5±0.3 (0.020±0.012)	-	2000
FB MH4525 (1810)	4.5±0.4 (0.177±0.016)	2.5±0.3 (0.098±0.012)	2.5±0.3 (0.098±0.012)	0.9±0.6 (0.035±0.024)	-	1000
FB MH4532 (1812)	4.5±0.4 (0.177±0.016)	3.2±0.3 (0.126±0.012)	3.2±0.3 (0.126±0.012)	0.9±0.6 (0.035±0.024)	-	2000

Unit: mm (inch)

▶ This catalog contains the typical specification only due to the limitation of space. When you consider the purchase of our products, please check our specification. For details of each product (characteristics graph, reliability information, precautions for use, and so on), see our Web site (<http://www.ty-top.com/>).

■ PARTS NUMBER

Standard type

● FB MJ1608

Parts number	EHS	Nominal impedance (Ω)	Impedance tolerance	Measuring frequency [MHz]	DC Resistance [Ω] (max.)	Rated current [A] (max.)	Thickness [mm]
FB MJ1608HS280NT	RoHS	28	±30%	100	0.007	4.0	0.8 ±0.2
FB MJ1608HM230NT	RoHS	23	±30%	100	0.007	4.0	0.8 ±0.2

● FB MJ2125

Parts number	EHS	Nominal impedance (Ω)	Impedance tolerance	Measuring frequency [MHz]	DC Resistance [Ω] (max.)	Rated current [A] (max.)	Thickness [mm]
FB MJ2125HS250NT	RoHS	25	±30%	100	0.004	6.0	0.85 ±0.2
FB MJ2125HS420-T	RoHS	42	±25%	100	0.008	4.0	0.85 ±0.2
FB MJ2125HM210NT	RoHS	21	±30%	100	0.004	6.0	0.85 ±0.2
FB MJ2125HM330-T	RoHS	33	±25%	100	0.008	4.0	0.85 ±0.2
FB MJ2125HL8R0NT	RoHS	8	±30%	100	0.008	4.0	0.85 ±0.2

● FB MJ3216

Parts number	EHS	Nominal impedance (Ω)	Impedance tolerance	Measuring frequency [MHz]	DC Resistance [Ω] (max.)	Rated current [A] (max.)	Thickness [mm]
FB MJ3216HS480NT	RoHS	48	±30%	100	0.005	6.0	1.1 ±0.2
FB MJ3216HS800-T	RoHS	80	±25%	100	0.010	4.0	1.1 ±0.2
FB MJ3216HM380NT	RoHS	38	±30%	100	0.005	6.0	1.1 ±0.2
FB MJ3216HM600-T	RoHS	60	±25%	100	0.010	4.0	1.1 ±0.2
FB MJ3216HL160NT	RoHS	16	±30%	100	0.012	4.0	1.1 ±0.2

● FB MJ4516

Parts number	EHS	Nominal impedance (Ω)	Impedance tolerance	Measuring frequency [MHz]	DC Resistance [Ω] (max.)	Rated current [A] (max.)	Thickness [mm]
FB MJ4516HS720NT	RoHS	72	±30%	100	0.007	6.0	1.1 ±0.2
FB MJ4516HS111-T	RoHS	110	±25%	100	0.014	4.0	1.1 ±0.2
FB MJ4516HM560NT	RoHS	56	±30%	100	0.007	6.0	1.1 ±0.2
FB MJ4516HM900-T	RoHS	90	±25%	100	0.014	4.0	1.1 ±0.2
FB MJ4516HL230NT	RoHS	23	±30%	100	0.014	3.5	1.1 ±0.2

High impedance type

● FB MH1608

Parts number	EHS	Nominal impedance (Ω)	Impedance tolerance	Measuring frequency [MHz]	DC Resistance [Ω] (max.)	Rated current [A] (max.)	Thickness [mm]
FB MH1608HM470-T	RoHS	47	±25%	100	0.020	3.5	0.8 ±0.1
FB MH1608HM600-T	RoHS	60	±25%	100	0.025	3.0	0.8 ±0.1
FB MH1608HM101-T	RoHS	100	±25%	100	0.035	2.5	0.8 ±0.1
FB MH1608HM151-T	RoHS	150	±25%	100	0.050	2.1	0.8 ±0.1
FB MH1608HM221-T	RoHS	220	±25%	100	0.070	1.8	0.8 ±0.1
FB MH1608HM331-T	RoHS	330	±25%	100	0.130	1.2	0.8 ±0.1
FB MH1608HM471-T	RoHS	470	±25%	100	0.150	1.0	0.8 ±0.1
FB MH1608HM601-T	RoHS	600	±25%	100	0.170	0.9	0.8 ±0.1
FB MH1608HM102-T	RoHS	1000	±25%	100	0.350	0.6	0.8 ±0.1
FB MH1608HL300-T	RoHS	30	±25%	100	0.028	2.6	0.8 ±0.1
FB MH1608HL600-T	RoHS	60	±25%	100	0.045	2.1	0.8 ±0.1
FB MH1608HL121-T	RoHS	120	±25%	100	0.130	1.2	0.8 ±0.1
FB MH1608HL221-T	RoHS	220	±25%	100	0.170	0.9	0.8 ±0.1
FB MH1608HL331-T	RoHS	330	±25%	100	0.210	0.8	0.8 ±0.1
FB MH1608HL471-T	RoHS	470	±25%	100	0.350	0.6	0.8 ±0.1
FB MH1608HL601-T	RoHS	600	±25%	100	0.450	0.5	0.8 ±0.1

● FB MH2012

Parts number	EHS	Nominal impedance (Ω)	Impedance tolerance	Measuring frequency [MHz]	DC Resistance [Ω] (max.)	Rated current [A] (max.)	Thickness [mm]
FB MH2012HM800-T	RoHS	80	±25%	100	0.025	2.7	0.85 ±0.2
FB MH2012HM121-T	RoHS	120	±25%	100	0.032	2.5	0.85 ±0.2
FB MH2012HM221-T	RoHS	220	±25%	100	0.060	2.0	0.85 ±0.2
FB MH2012HM331-T	RoHS	330	±25%	100	0.080	1.8	0.85 ±0.2

● FB MH2016

Parts number	EHS	Nominal impedance (Ω)	Impedance tolerance	Measuring frequency [MHz]	DC Resistance [Ω] (max.)	Rated current [A] (max.)	Thickness [mm]
FB MH2016HM121NT	RoHS	120	±30%	100	0.015	4.5	1.6 ±0.2
FB MH2016HM251NT	RoHS	250	±30%	100	0.050	2.0	1.6 ±0.2

● FB MH3216

Parts number	EHS	Nominal impedance (Ω)	Impedance tolerance	Measuring frequency [MHz]	DC Resistance [Ω] (max.)	Rated current [A] (max.)	Thickness [mm]
FB MH3216HM221NT	RoHS	220	±30%	100	0.020	4.0	1.6 ±0.2
FB MH3216HM501NT	RoHS	500	±30%	100	0.070	2.0	1.6 ±0.2

● FB MH3225

Parts number	EHS	Nominal impedance (Ω)	Impedance tolerance	Measuring frequency [MHz]	DC Resistance [Ω] (max.)	Rated current [A] (max.)	Thickness [mm]
FB MH3225HM601NT	RoHS	600	±30%	100	0.042	3.0	2.5 ±0.3
FB MH3225HM102NT	RoHS	1000	±30%	100	0.100	2.0	2.5 ±0.3
FB MH3225HM202NT	RoHS	2000	±30%	100	0.130	1.2	2.5 ±0.3

▶ This catalog contains the typical specification only due to the limitation of space. When you consider the purchase of our products, please check our specification. For details of each product (characteristics graph, reliability information, precautions for use, and so on), see our Web site (<http://www.ty-top.com/>).

■ PARTS NUMBER

● FB MH4516

Parts number	EHS	Nominal impedance [Ω]	Impedance tolerance	Measuring frequency [MHz]	DC Resistance [Ω] (max.)	Rated current [A] (max.)	Thickness [mm]
FB MH4516HM851NT	RoHS	850	±30%	100	0.100	1.5	1.6 ±0.2

● FB MH4525

Parts number	EHS	Nominal impedance [Ω]	Impedance tolerance	Measuring frequency [MHz]	DC Resistance [Ω] (max.)	Rated current [A] (max.)	Thickness [mm]
FB MH4525HM102NT	RoHS	1000	±30%	100	0.060	3.0	2.5 ±0.3
FB MH4525HM162NT	RoHS	1600	±30%	100	0.130	2.0	2.5 ±0.3

● FB MH4532

Parts number	EHS	Nominal impedance [Ω]	Impedance tolerance	Measuring frequency [MHz]	DC Resistance [Ω] (max.)	Rated current [A] (max.)	Thickness [mm]
FB MH4532HM681-T	RoHS	680	±25%	100	0.028	4.0	3.2 ±0.3
FB MH4532HM132-T	RoHS	1300	±25%	100	0.060	3.0	3.2 ±0.3
FB MH4532HM202-T	RoHS	2000	±25%	100	0.130	1.3	3.2 ±0.3

● High current type

Parts number	EHS	Nominal impedance [Ω]	Impedance tolerance	Measuring frequency [MHz]	DC Resistance [Ω] (max.)	Rated current [A] (max.)	Thickness [mm]
FB MJ1608HS220NTR	RoHS	22	±30%	100	0.004	7.5	0.8 ±0.2
FB MJ1608HS280NTR	RoHS	28	±30%	100	0.006	6.0	0.8 ±0.2
FB MJ1608HM180NTR	RoHS	18	±30%	100	0.004	7.5	0.8 ±0.2
FB MJ1608HM230NTR	RoHS	23	±30%	100	0.006	6.0	0.8 ±0.2

► This catalog contains the typical specification only due to the limitation of space. When you consider the purchase of our products, please check our specification. For details of each product (characteristics graph, reliability information, precautions for use, and so on), see our Web site (<http://www.ty-top.com/>).

FB MJ1608

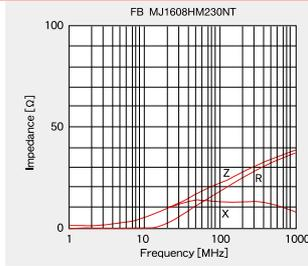
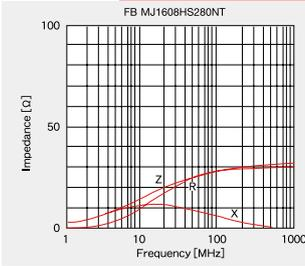

FB MJ2125

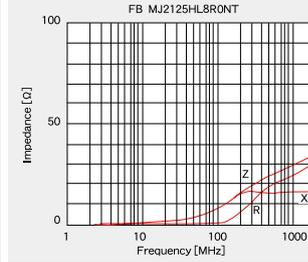
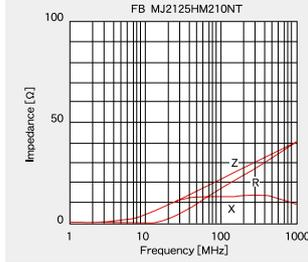
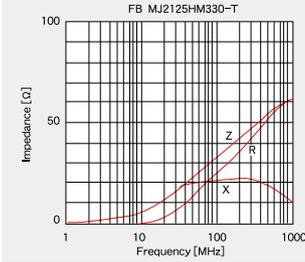
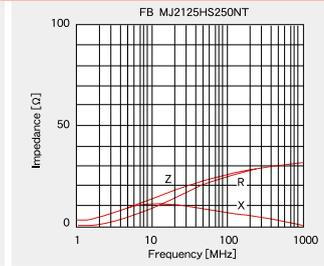
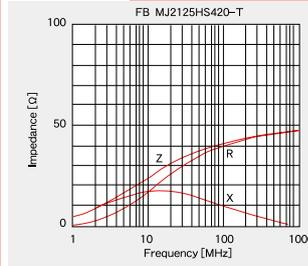

FB MJ3216

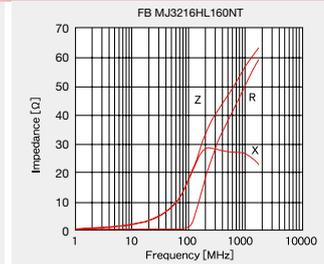
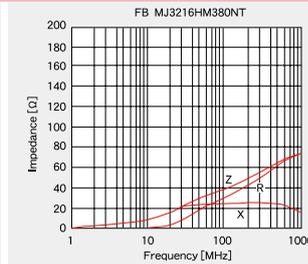
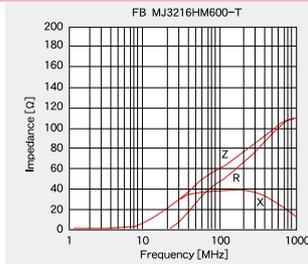
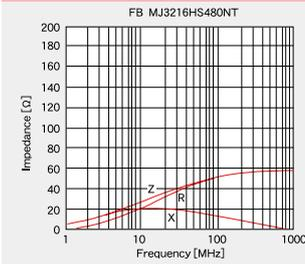
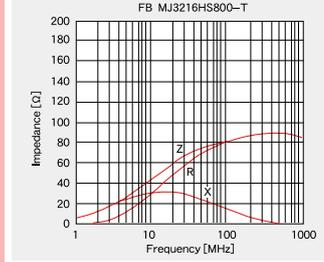

FB MJ4516

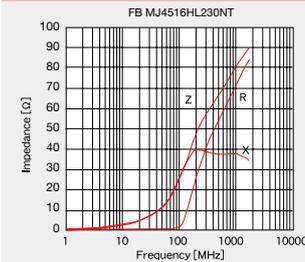
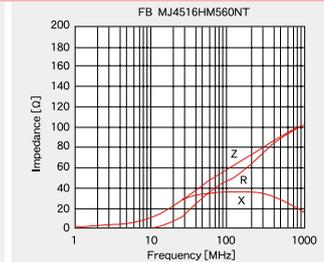
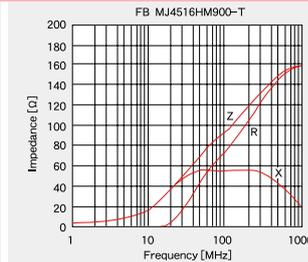
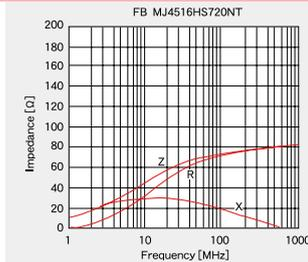
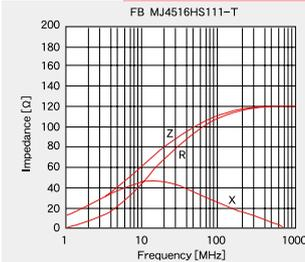

▶ This catalog contains the typical specification only due to the limitation of space. When you consider the purchase of our products, please check our specification. For details of each product (characteristics graph, reliability information, precautions for use, and so on), see our Web site (<http://www.ty-top.com/>).

Standard type

FB MH1608

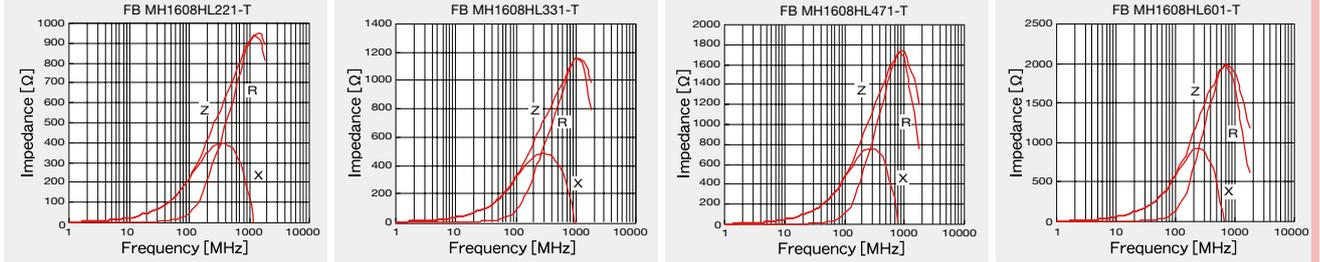
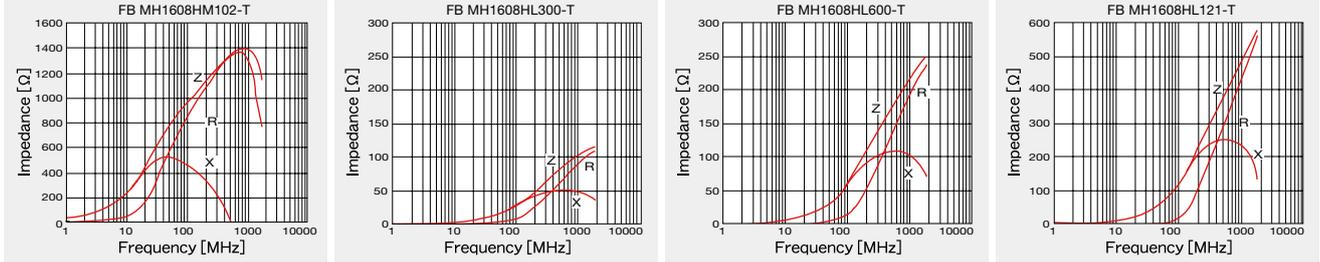
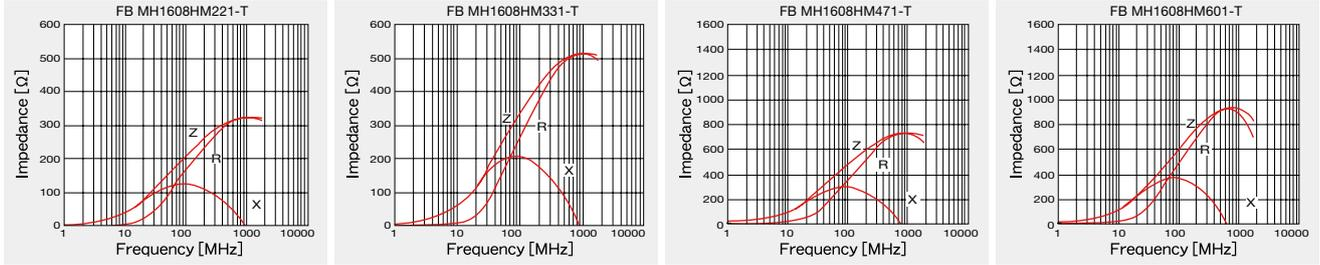
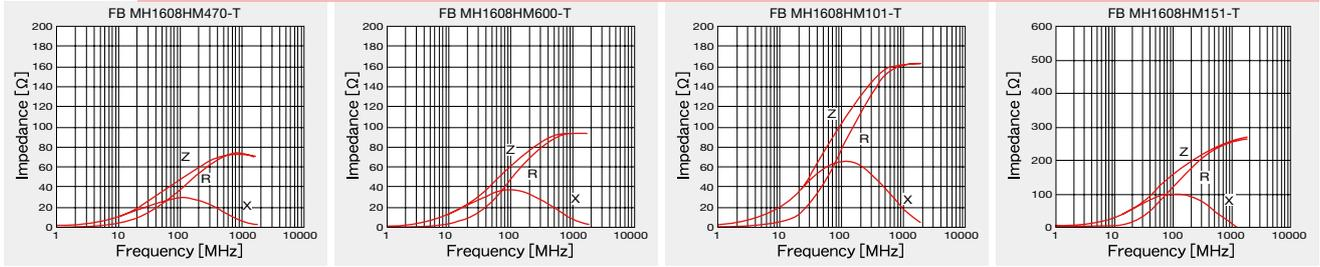

FBMH2012

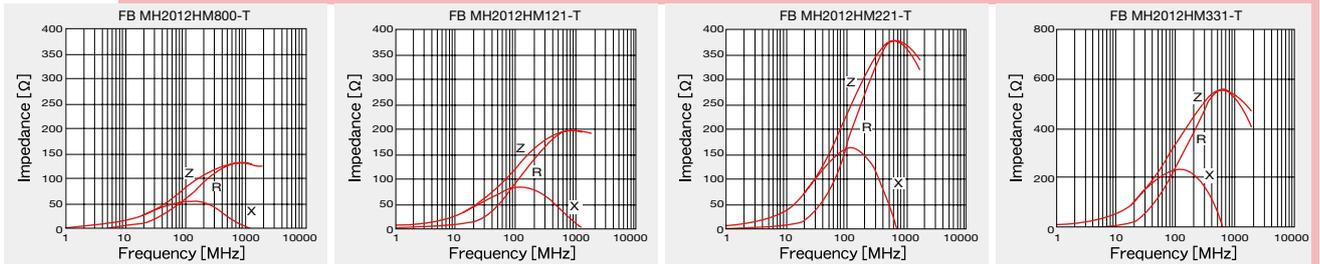

FB MH2016

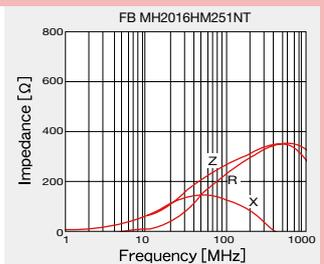
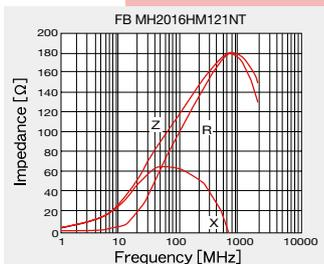

FB MH3216

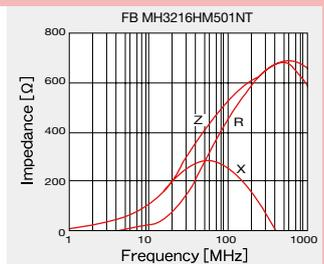
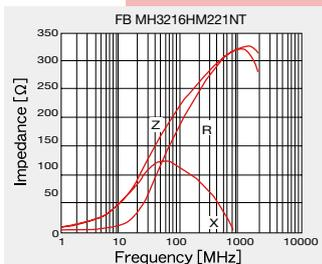

▶ This catalog contains the typical specification only due to the limitation of space. When you consider the purchase of our products, please check our specification. For details of each product (characteristics graph, reliability information, precautions for use, and so on), see our Web site (<http://www.ty-top.com/>).

Standard type

FB MH3225

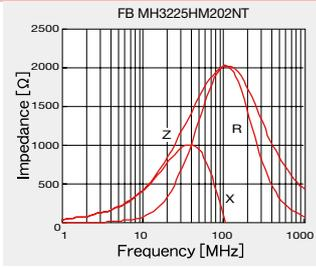
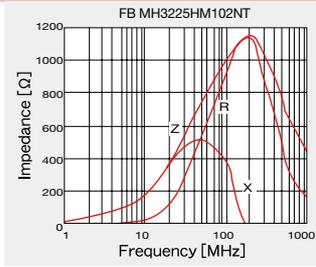
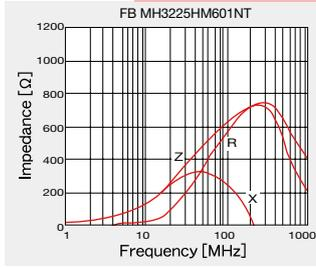

FB MH4516

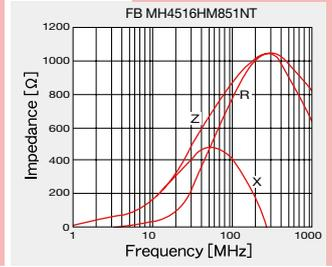

FB MH4525

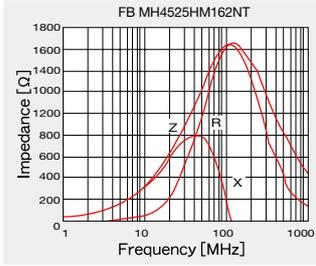
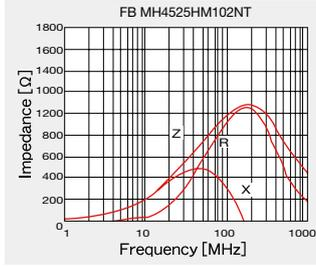

FB MH4532

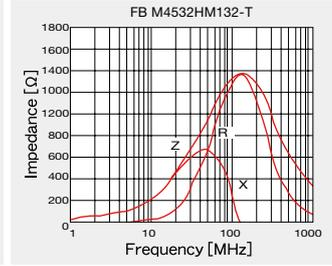
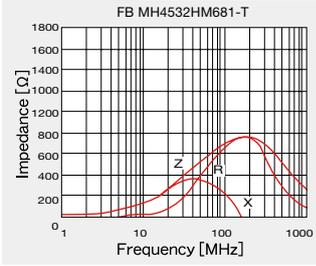

High current type

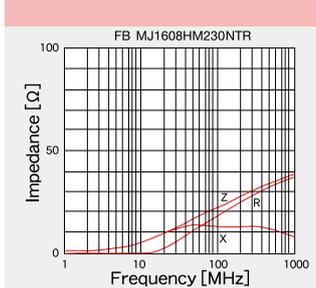
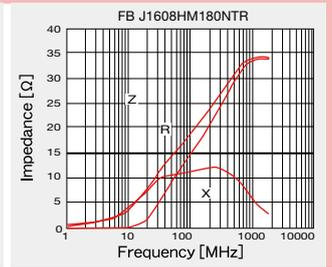
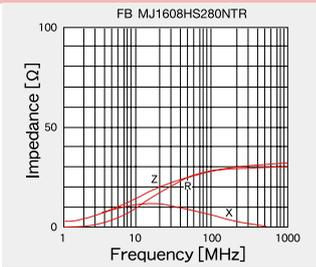
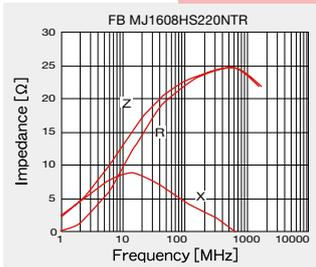
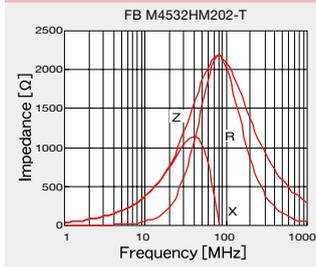

▶ This catalog contains the typical specification only due to the limitation of space. When you consider the purchase of our products, please check our specification. For details of each product (characteristics graph, reliability information, precautions for use, and so on), see our Web site (<http://www.ty-top.com/>).

CHIP BEAD INDUCTORS FOR POWER LINES (FB SERIES M TYPE)

PACKAGING

① Minimum Quantity

Type	Standard Quantity [pcs]	
	Paper Tape	Embossed Tape
1608 (0603)	4000	—
2125 (0805)	4000	—
2012 (0805)	4000	—
2016 (0806)	—	2000
3216 (1206)	—	2000
3225 (1210)	—	1000
4516 (1806)	—	2000
4525 (1810)	—	1000
4532 (1812)	—	2000

② Tape Material

● Card board carrier tape

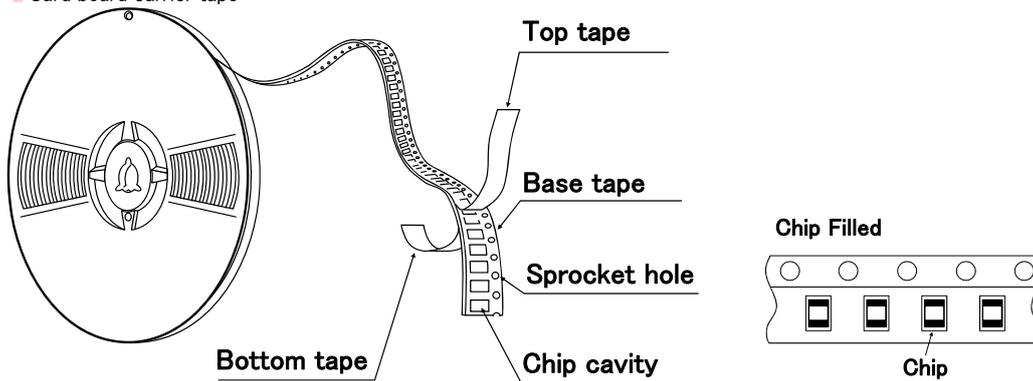

● Embossed tape

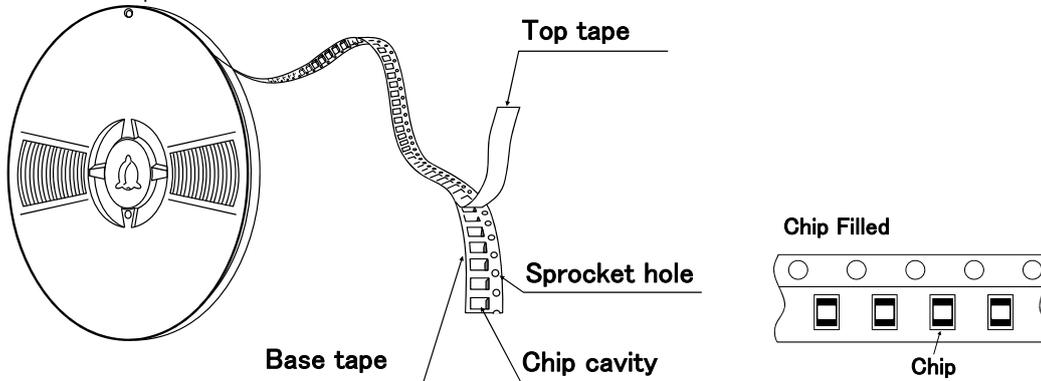

③ Taping Dimensions

● Paper tape (0.315 inches wide)

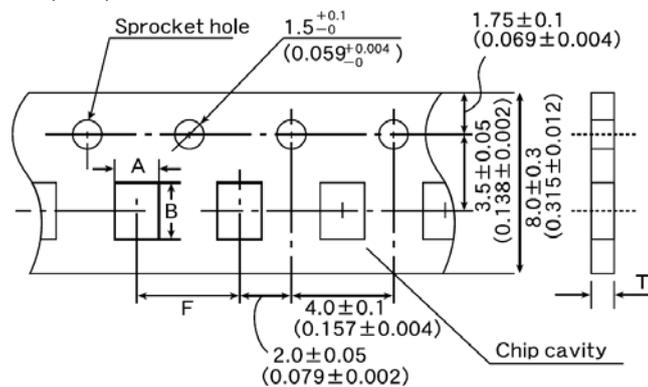

▶ This catalog contains the typical specification only due to the limitation of space. When you consider the purchase of our products, please check our specification. For details of each product (characteristics graph, reliability information, precautions for use, and so on), see our Web site (<http://www.ty-top.com/>).

Type	Chip Cavity		Insertion Pitch	Tape Thickness
	A	B	F	T
FBMJ1608 FBMH1608 (0603)	1.0±0.2 (0.039±0.008)	1.8±0.2 (0.071±0.008)	4.0±0.2 (0.157±0.008)	1.1max (0.043max)
FBMJ2125 FBMH2012 (0805)	1.5±0.2 (0.059±0.008)	2.3±0.2 (0.091±0.008)	4.0±0.2 (0.157±0.008)	1.1max (0.043max)

Unit : mm (inch)

● Embossed tape (0.315 inches wide)

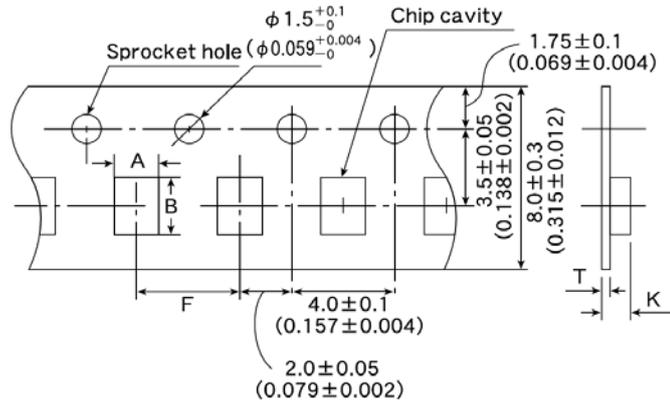

Type	Chip Cavity		Insertion Pitch	Tape Thickness	
	A	B	F	K	T
FBMH2016 (0806)	1.8±0.2 (0.071±0.008)	2.2±0.2 (0.087±0.008)	4.0±0.2 (0.157±0.008)	2.6max (0.102max)	0.6max (0.024max)
FBMJ3216 (1206)	1.9±0.2 (0.075±0.008)	3.5±0.2 (0.138±0.008)	4.0±0.2 (0.157±0.008)	1.5max (0.059max)	0.3max (0.012max)
FBMH3216 (1206)	1.9±0.2 (0.075±0.008)	3.5±0.2 (0.138±0.008)	4.0±0.2 (0.157±0.008)	2.6max (0.102max)	0.6max (0.024max)
FBMH3225 (1210)	2.8±0.2 (0.110±0.008)	3.5±0.2 (0.138±0.008)	4.0±0.2 (0.157±0.008)	4.0max (0.157max)	0.6max (0.024max)

Unit : mm (inch)

● Embossed tape (0.472 inches wide)

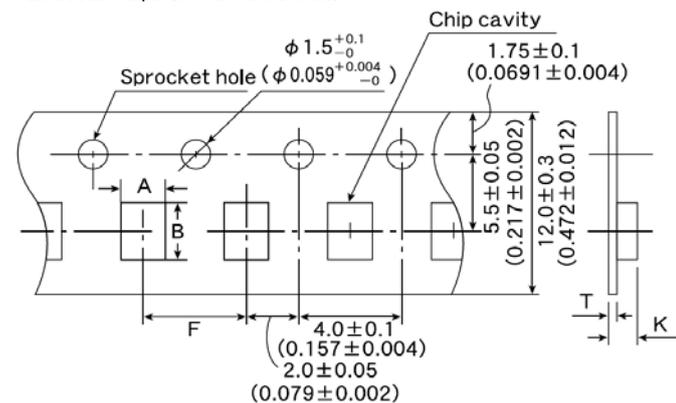

Type	Chip Cavity		Insertion Pitch	Tape Thickness	
	A	B	F	K	T
FBMJ4516 (1806)	1.9±0.2 (0.075±0.008)	4.9±0.2 (0.193±0.008)	4.0±0.2 (0.157±0.008)	1.5max (0.059max)	0.3max (0.012max)
FBMH4516 (1806)	1.9±0.2 (0.075±0.008)	4.9±0.2 (0.193±0.008)	4.0±0.2 (0.157±0.008)	2.6max (0.102max)	0.6max (0.024max)
FBMH4525 (1810)	2.9±0.2 (0.114±0.008)	4.9±0.2 (0.193±0.008)	4.0±0.2 (0.157±0.008)	4.0max (0.157max)	0.6max (0.024max)
FBMH4532 (1812)	3.6±0.2 (0.142±0.008)	4.9±0.2 (0.193±0.008)	8.0±0.2 (0.315±0.008)	4.0max (0.157max)	0.6max (0.024max)

Unit : mm (inch)

▶ This catalog contains the typical specification only due to the limitation of space. When you consider the purchase of our products, please check our specification. For details of each product (characteristics graph, reliability information, precautions for use, and so on), see our Web site (<http://www.ty-top.com/>).

④ Leader and Blank portion

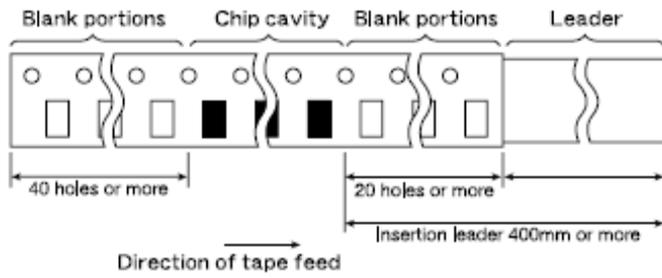

Insertion leader is 400 mm or more (including 20 empty cavities)
Empty cavities at end of reel: 40 holes or more

⑤ Reel size

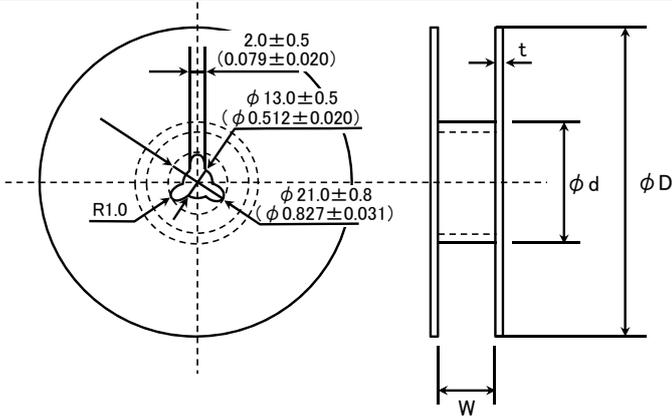

Type	ϕD	ϕd	W	t
FBMJ1608	180+0/-3 (7.09+0/-0.118)	60+1/-0 (2.36+0.039/-0)	10.0±1.5 (0.394±0.059)	2.5max (0.098max)
FBMJ2125			14.0±1.5 (0.551±0.059)	
FBMJ3216				
FBMJ4516			10.0±1.5 (0.394±0.059)	
FBMH1608				
FBMH2012				
FBMH2016				
FBMH3216			14.0±1.5 (0.551±0.059)	
FBMH3225				
FBMH4516			330±2.0 (12.99±0.080)	100±1.0 (3.94±0.039)
FBMH4525				
FBMH4532				

Unit : mm (inch)

⑥ Top tape strength

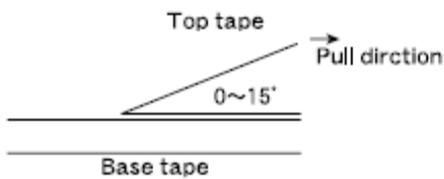

The top tape requires a peel-off force of 0.1 to 0.7N in the direction of the arrow as illustrated below.

CHIP BEAD INDUCTORS FOR POWER LINE (FB SERIES M TYPE)

RELIABILITY DATA

1. Operating Temperature Range	
Specified Value	-40°C ~ +125°C Including self-generated heat
2. Storage Temperature Range	
Specified Value	-40°C ~ +85°C
Test Methods and Remarks	*Note: -5 to +40°C in taped packaging
3. Impedance	
Specified Value	Within the specified tolerance
Test Methods and Remarks	Measuring equipment : Impedance analyzer (HP4291A) or its equivalent Measuring frequency : 100±1 MHz
4. DC Resistance	
Specified Value	Within the specified range
Test Methods and Remarks	Four-terminal method Measuring equipment : Milliohm High-Tester 3226 (Hioki Denki) or its equivalent
5. Rated Current	
Specified Value	Within the specified range
6. Vibration	
Specified Value	Appearance : No significant abnormality Impedance change : Within ±30% of the initial value
Test Methods and Remarks	According to JIS C 0040. Vibration type : A Time : 2 hrs each in X,Y, and Z directions Total: 6 hrs Frequency range : 10 to 55 to 10Hz (/min.) Amplitude : 1.5 mm (shall not exceed acceleration 196m/s ²) Mounting method : Soldering onto PC board
7. Solderability	
Specified Value	90% or more of immersed surface of terminal electrode shall be covered with fresh solder.
Test Methods and Remarks	Solder temperature : 230±5°C Immersion time : 4±1 sec. Preconditioning : Immersion into flux. Immersion and Removal speed : 25mm/sec.
8. Resistance to Soldering Heat	
Specified Value	Appearance : No significant abnormality Impedance change : Within ±30% of the initial value
Test Methods and Remarks	Preheating : 150°C for 3 min. Resistance to Soldering Heat : 260±5°C Duration : 10±0.5 sec. Preconditioning : Immersion into flux. Immersion and Removal speed : 25mm/sec. Recovery : 2 to 3 hrs of recovery under the standard condition after the test.

▶ This catalog contains the typical specification only due to the limitation of space. When you consider the purchase of our products, please check our specification. For details of each product (characteristics graph, reliability information, precautions for use, and so on), see our Web site (<http://www.ty-top.com/>).

9. Thermal Shock															
Specified Value	Appearance : No significant abnormality Impedance change : Within +50/−10% of the initial value														
Test Methods and Remarks	According to JIS C 0025. Conditions for 1 cycle														
	<table border="1"> <thead> <tr> <th>Step</th> <th>Temperature (°C)</th> <th>Duration (min.)</th> </tr> </thead> <tbody> <tr> <td>1</td> <td>−40±3°C</td> <td>30±3</td> </tr> <tr> <td>2</td> <td>Room Temperature</td> <td>Within 3</td> </tr> <tr> <td>3</td> <td>85±2°C</td> <td>30±3</td> </tr> <tr> <td>4</td> <td>Room Temperature</td> <td>Within 3</td> </tr> </tbody> </table>	Step	Temperature (°C)	Duration (min.)	1	−40±3°C	30±3	2	Room Temperature	Within 3	3	85±2°C	30±3	4	Room Temperature
Step	Temperature (°C)	Duration (min.)													
1	−40±3°C	30±3													
2	Room Temperature	Within 3													
3	85±2°C	30±3													
4	Room Temperature	Within 3													
	Number of cycles : 100 Mounting method : Soldering onto PC board Recovery : 2 to 3 hrs of recovery under the standard condition after the removal from test chamber.														

10. Resistance to Humidity (steady state)	
Specified Value	Appearances : No significant abnormality Impedance change : Within ±30% of the initial value
Test Methods and Remarks	Temperature : 40±2°C Humidity : 90 to 95% RH Duration : 500+24/−0 Mounting method : Soldering onto PC board Recovery : 2 to 3 hrs of recovery under the standard condition after the removal from test chamber.

11. Loading under Damp Heat	
Specified Value	Appearance : No significant abnormality Impedance change : Within ±30% of the initial value
Test Methods and Remarks	Temperature : 40±2°C Humidity : 90 to 95%RH Applied current : Rated current Duration : 500+24/−0 hrs Mounting method : Soldering onto PC board Recovery : 2 to 3hrs of recovery under the standard condition after the removal from test chamber.

12. High Temperature Loading Test	
Specified Value	Appearance : No significant abnormality Impedance change : Within ±30% of the initial value
Test Methods and Remarks	Temperature : 85±2°C Duration : 500+24/−0 hrs Applied current : Rated current Mounting method : Soldering onto PC board Recovery : 2 to 3 hrs of recovery under the standard condition after the removal from test chamber.

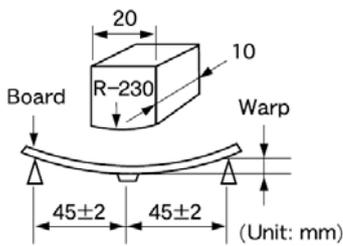
13. Bending Strength	
Specified Value	Appearance : No mechanical damage.
Test Methods and Remarks	<p>Warp : 2mm Testing board : Glass epoxy-resin substrate Thickness : 0.8mm</p>  <p>(Unit: mm)</p>

▶ This catalog contains the typical specification only due to the limitation of space. When you consider the purchase of our products, please check our specification. For details of each product (characteristics graph, reliability information, precautions for use, and so on), see our Web site (<http://www.ty-top.com/>).

14. Adhesion of Electrode

Specified Value No separation or indication of separation of electrode.

Test Methods and Remarks

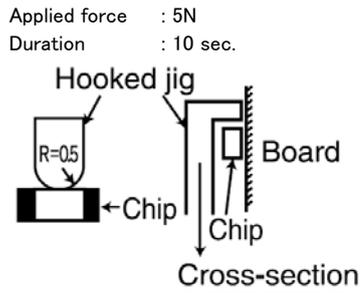

Note on standard condition: "standard condition" referred to herein is defined as follows:
5 to 35°C of temperature, 45 to 85% relative humidity and 86 to 106kPa of air pressure.

When there are questions concerning measurement results:

In order to provide correlation data, the test shall be conducted under condition of $20 \pm 2^\circ\text{C}$ of temperature, 60 to 70% relative humidity and 86 to 106kPa of air pressure. Unless otherwise specified, all the tests are conducted under the "standard condition."

CHIP BEAD INDUCTORS FOR POWER LINE (FB SERIES M TYPE)

PRECAUTIONS

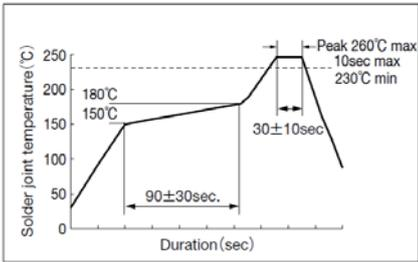
1. Circuit Design	
Precautions	<ul style="list-style-type: none"> ◆ Operating environment <ol style="list-style-type: none"> 1. The products described in this specification are intended for use in general electronic equipment, (office supply equipment, telecommunications systems, measuring equipment, and household equipment). They are not intended for use in mission-critical equipment or systems requiring special quality and high reliability (traffic systems, safety equipment, aerospace systems, nuclear control systems and medical equipment including life-support systems,) where product failure might result in loss of life, injury or damage. For such uses, contact TAIYO YUDEN Sales Department in advance. ◆ Rated current <ol style="list-style-type: none"> 1. Rated current of this product is shown in this catalogue, but please be sure to have the base board designed with adequate inspection in case of the generation of heat becomes high within the rated current range when the base board is in high resistance or in bad heating conditions.
2. PCB Design	
Precautions	<ul style="list-style-type: none"> ◆ Land pattern design <ol style="list-style-type: none"> 1. Please refer to a recommended land pattern.
3. Considerations for automatic placement	
Precautions	<ul style="list-style-type: none"> ◆ Adjustment of mounting machine <ol style="list-style-type: none"> 1. Excessive impact load should not be imposed on the products when mounting onto the PC boards. 2. Mounting and soldering conditions should be checked beforehand.
Technical considerations	<ul style="list-style-type: none"> ◆ Adjustment of mounting machine <ol style="list-style-type: none"> 1. When installing products, care should be taken not to apply distortion stress as it may deform the products.
4. Soldering	
Precautions	<ul style="list-style-type: none"> ◆ Wave soldering <ol style="list-style-type: none"> 1. Please refer to the specifications in the catalog for a wave soldering. ◆ Reflow soldering <ol style="list-style-type: none"> 1. Please contact any of our offices for a reflow soldering, and refer to the recommended condition specified. ◆ Lead free soldering <ol style="list-style-type: none"> 1. When using products with lead free soldering, we request to use them after confirming adhesion, temperature of resistance to soldering heat, etc. sufficiently. ◆ Preheating when soldering <p>Heating : The temperature difference between soldering and remaining heat should not be greater than 150°C.</p> <p>Cooling : The temperature difference between the components and cleaning process should not be greater than 100°C.</p> ◆ Recommended conditions for using a soldering iron <p>Put the soldering iron on the land-pattern.</p> <p>Soldering iron's temperature – Below 350°C</p> <p>Duration – 3 seconds or less</p> <p>The soldering iron should not directly touch the inductor.</p>
Technical considerations	<ul style="list-style-type: none"> ◆ Wave, Reflow, Lead free soldering <ol style="list-style-type: none"> 1. If products are used beyond the range of the recommended conditions, heat stresses may deform the products, and consequently degrade the reliability of the products. <p>【Recommended reflow condition】</p>  ◆ Preheating when soldering <ol style="list-style-type: none"> 1. There is a case that products get damaged by a heat shock. ◆ Recommended conditions for using a soldering iron <ol style="list-style-type: none"> 1. If products are used beyond the range of the recommended conditions, heat stresses may deform the products, and consequently degrade the reliability of the products.

5. Handling	
Precautions	<ul style="list-style-type: none"> ◆ Handling <ol style="list-style-type: none"> 1. Keep the inductors away from all magnets and magnetic objects. ◆ Setting PC boards <ol style="list-style-type: none"> 1. When setting a chip mounted base board, please make sure that there is no residual stress to the chip by distortion in the board or at screw part. ◆ Breakaway PC boards (splitting along perforations) <ol style="list-style-type: none"> 1. When splitting the PC board after mounting inductors, care should be taken not to give any stresses of deflection or twisting to the board. 2. Board separation should not be done manually, but by using the appropriate devices. ◆ Mechanical considerations <ol style="list-style-type: none"> 1. Please do not give the inductors any excessive mechanical shocks.
Technical considerations	<ul style="list-style-type: none"> ◆ Handling <ol style="list-style-type: none"> 1. There is a case that a characteristic varies with magnetic influence. ◆ Setting PC boards <ol style="list-style-type: none"> 1. There is a case that a characteristic varies with residual stress. ◆ Breakaway PC boards (splitting along perforations) <ol style="list-style-type: none"> 1. Planning pattern configurations and the position of products should be carefully performed to minimize stress. ◆ Mechanical considerations <ol style="list-style-type: none"> 1. There is a case to be damaged by a mechanical shock.
6. Storage conditions	
Precautions	<ul style="list-style-type: none"> ◆ Storage <ol style="list-style-type: none"> 1. To maintain the solderability of terminal electrodes and to keep the packing material in good condition, temperature and humidity in the storage area should be controlled. <ul style="list-style-type: none"> • Recommended conditions <ul style="list-style-type: none"> Ambient temperature 0~40°C Humidity Below 70% RH <p>The ambient temperature must be kept below 30°C. Even under ideal storage conditions, solderability of products electrodes may decrease as time passes. For this reason, inductors should be used within 6 months from the time of delivery.</p>
Technical considerations	<ul style="list-style-type: none"> ◆ Storage <ol style="list-style-type: none"> 1. Under a high temperature and humidity environment, problems such as reduced solderability caused by oxidation of terminal electrodes and deterioration of taping/packaging materials may take place.

Данный компонент на территории Российской Федерации

Вы можете приобрести в компании MosChip.

Для оперативного оформления запроса Вам необходимо перейти по данной ссылке:

<http://moschip.ru/get-element>

Вы можете разместить у нас заказ для любого Вашего проекта, будь то серийное производство или разработка единичного прибора.

В нашем ассортименте представлены ведущие мировые производители активных и пассивных электронных компонентов.

Нашей специализацией является поставка электронной компонентной базы двойного назначения, продукции таких производителей как XILINX, Intel (ex.ALTERA), Vicor, Microchip, Texas Instruments, Analog Devices, Mini-Circuits, Amphenol, Glenair.

Сотрудничество с глобальными дистрибьюторами электронных компонентов, предоставляет возможность заказывать и получать с международных складов практически любой перечень компонентов в оптимальные для Вас сроки.

На всех этапах разработки и производства наши партнеры могут получить квалифицированную поддержку опытных инженеров.

Система менеджмента качества компании отвечает требованиям в соответствии с ГОСТ Р ИСО 9001, ГОСТ РВ 0015-002 и ЭС РД 009

Офис по работе с юридическими лицами:

105318, г.Москва, ул.Щербаковская д.3, офис 1107, 1118, ДЦ «Щербаковский»

Телефон: +7 495 668-12-70 (многоканальный)

Факс: +7 495 668-12-70 (доб.304)

E-mail: info@moschip.ru

Skype отдела продаж:

moschip.ru

moschip.ru_4

moschip.ru_6

moschip.ru_9