

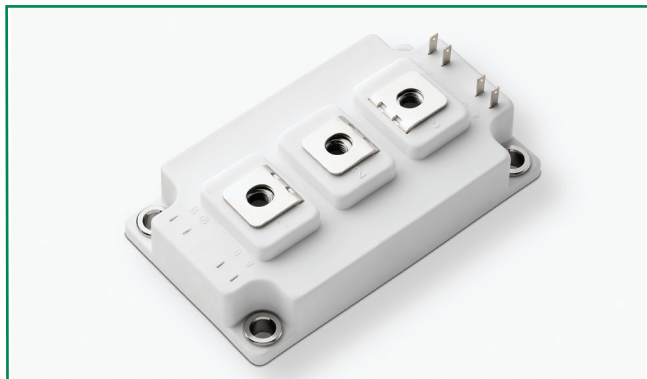

MG17100D-BN4MM



Agency Approvals

AGENCY	AGENCY FILE NUMBER
	E71639

Features

- IGBT³ CHIP(1700V Trench+Field Stop technology)
- Low turn-off losses, short tail current
- $V_{CE(sat)}$ with positive temperature coefficient
- DIODE CHIP(1700V EMCON 3 technology)
- Free wheeling diodes with fast and soft reverse recovery

Applications

- High frequency switching application
- Medical applications
- Motion/servo control
- UPS systems

Module Characteristics ($T_c = 25^\circ\text{C}$, unless otherwise specified)

Symbol	Parameters	Test Conditions	Min	Typ	Max	Unit
$T_{J(max)}$	Max. Junction Temperature				150	$^\circ\text{C}$
$T_{J(op)}$	Operating Temperature		-40		125	$^\circ\text{C}$
T_{stg}	Storage Temperature		-40		125	$^\circ\text{C}$
V_{isol}	Insulation Test Voltage	AC, t=1min		4000		V
CTI	Comparative Tracking Index		350			
Torque	Module-to-Sink	Recommended (M6)	3		5	N·m
Torque	Module Electrodes	Recommended (M6)	2.5		5	N·m
Weight				320		g

Absolute Maximum Ratings ($T_c = 25^\circ\text{C}$, unless otherwise specified)

Symbol	Parameters	Test Conditions	Values	Unit
IGBT				
V_{CES}	Collector - Emitter Voltage	$T_J=25^\circ\text{C}$	1700	V
V_{GES}	Gate - Emitter Voltage		± 20	V
I_C	DC Collector Current	$T_c=25^\circ\text{C}$	150	A
		$T_c=80^\circ\text{C}$	100	A
I_{CM}	Repetitive Peak Collector Current	$t_p=1\text{ms}$	200	A
P_{tot}	Power Dissipation Per IGBT		690	W
Diode				
V_{RRM}	Repetitive Reverse Voltage	$T_J=25^\circ\text{C}$	1700	V
$I_{F(AV)}$	Average Forward Current	$T_c=25^\circ\text{C}$	150	A
		$T_c=80^\circ\text{C}$	100	A
I_{FRM}	Repetitive Peak Forward Current	$t_p=1\text{ms}$	200	A
I^2t		$T_J = 125^\circ\text{C}, t=10\text{ms}, V_R=0\text{V}$	1650	A^2S

Life Support Note:

Not Intended for Use in Life Support or Life Saving Applications

The products shown herein are not designed for use in life sustaining or life saving applications unless otherwise expressly indicated.

Electrical and Thermal Specifications ($T_c = 25^\circ\text{C}$, unless otherwise specified)

Symbol	Parameters	Test Conditions	Min	Typ	Max	Unit
IGBT						
$V_{GE(th)}$	Gate - Emitter Threshold Voltage	$V_{CE}=V_{GE}, I_C=4.0\text{mA}$	5.2	5.8	6.4	V
$V_{CE(sat)}$	Collector - Emitter Saturation Voltage	$I_C=100\text{A}, V_{GE}=15\text{V}, T_J=25^\circ\text{C}$		2.0	2.45	V
		$I_C=100\text{A}, V_{GE}=15\text{V}, T_J=125^\circ\text{C}$		2.4		V
I_{CES}	Collector Leakage Current	$V_{CE}=1700\text{V}, V_{GE}=0\text{V}, T_J=25^\circ\text{C}$			3	mA
		$V_{CE}=1700\text{V}, V_{GE}=0\text{V}, T_J=125^\circ\text{C}$			20	mA
I_{GES}	Gate Leakage Current	$V_{CE}=0\text{V}, V_{GE}=\pm 20\text{V}, T_J=125^\circ\text{C}$	-400		400	nA
R_{Gint}	Intergrated Gate Resistor			4.8		Ω
Q_{ge}	Gate Charge	$V_{CE}=900\text{V}, I_C=100\text{A}, V_{GE}=\pm 15\text{V}$		1.2		μC
C_{ies}	Input Capacitance	$V_{CE}=25\text{V}, V_{GE}=0\text{V}, f=1\text{MHz}$		9		nF
C_{res}	Reverse Transfer Capacitance				0.3	
$t_{d(on)}$	Turn - on Delay Time	$V_{CC}=900\text{V}$ $I_C=100\text{A}$ $R_G=4\Omega$ $V_{GE}=\pm 15\text{V}$ Inductive Load	$T_J=25^\circ\text{C}$		370	ns
			$T_J=125^\circ\text{C}$		400	ns
t_r	Rise Time		$T_J=25^\circ\text{C}$		40	ns
			$T_J=125^\circ\text{C}$		50	ns
$t_{d(off)}$	Turn - off Delay Time		$T_J=25^\circ\text{C}$		650	ns
			$T_J=125^\circ\text{C}$		800	ns
t_f	Fall Time		$T_J=25^\circ\text{C}$		180	ns
			$T_J=125^\circ\text{C}$		300	ns
E_{on}	Turn - on Energy		$T_J=25^\circ\text{C}$		22	mJ
			$T_J=125^\circ\text{C}$		32	mJ
E_{off}	Turn - off Energy	$T_J=25^\circ\text{C}$		21	mJ	
		$T_J=125^\circ\text{C}$		31	mJ	
I_{SC}	Short Circuit Current	$t_{psc}\leq 10\mu\text{S}, V_{GE}=15\text{V}, T_J=125^\circ\text{C}, V_{CC}=1000\text{V}$		400		A
R_{thJC}	Junction-to-Case Thermal Resistance (Per IGBT)				0.18	K/W
Diode						
V_F	Forward Voltage	$I_F=100\text{A}, V_{GE}=0\text{V}, T_J=25^\circ\text{C}$		1.8	2.2	V
		$I_F=100\text{A}, V_{GE}=0\text{V}, T_J=125^\circ\text{C}$		1.9		V
I_{RRM}	Max. Reverse Recovery Current	$I_F=100\text{A}, V_R=900\text{V}$		160		A
Q_{rr}	Reverse Recovery Charge	$di_f/dt=-2400\text{A}/\mu\text{s}$		48		μC
E_{rec}	Reverse Recovery Energy	$T_J=125^\circ\text{C}$		27		mJ
R_{thJCD}	Junction-to-Case Thermal Resistance (Per Diode)				0.26	K/W

Figure 1: Typical Output Characteristics

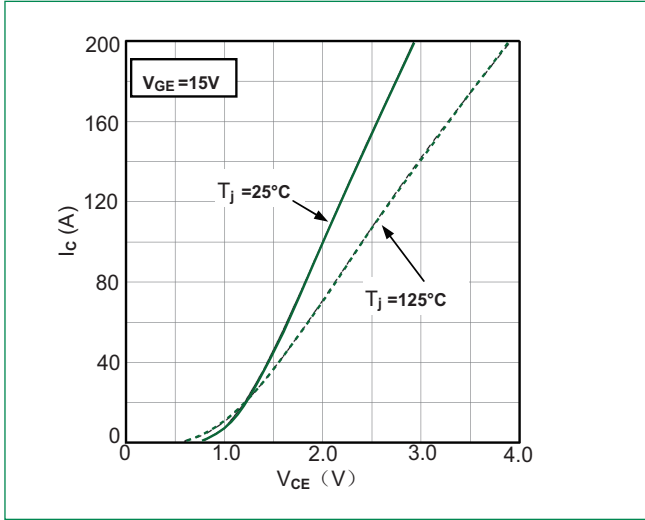

Figure 2: Typical Output Characteristics

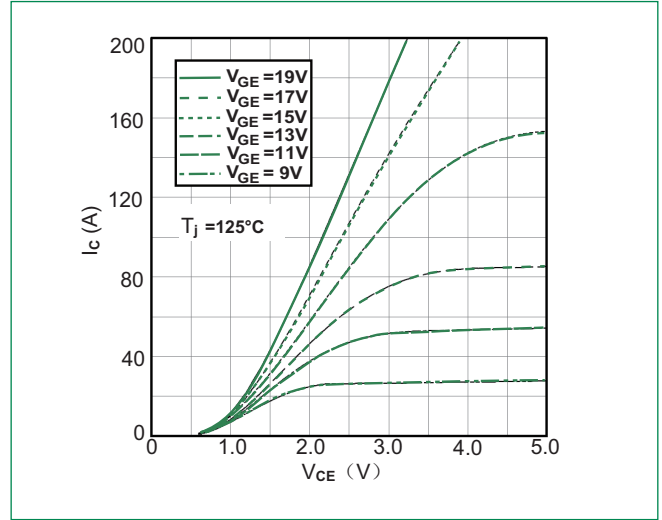

Figure 3: Typical Transfer characteristics

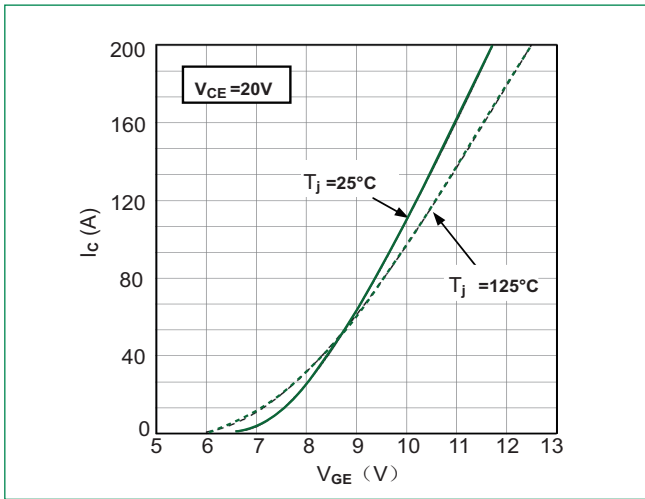

Figure 4: Switching Energy vs. Gate Resistor

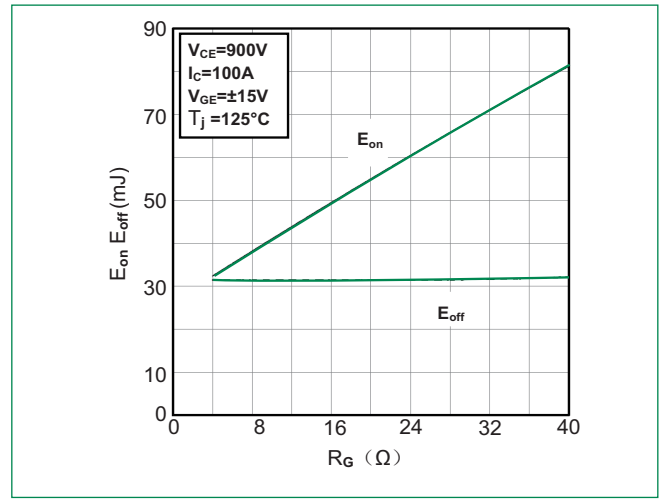

Figure 5: Switching Energy vs. Collector Current

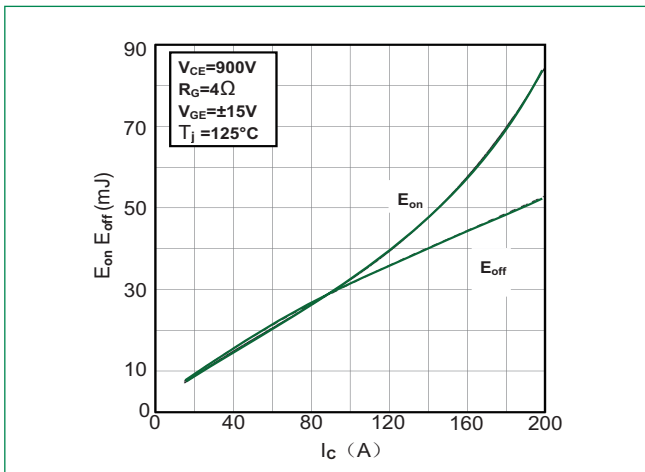

Figure 6: Reverse Biased Safe Operating Area

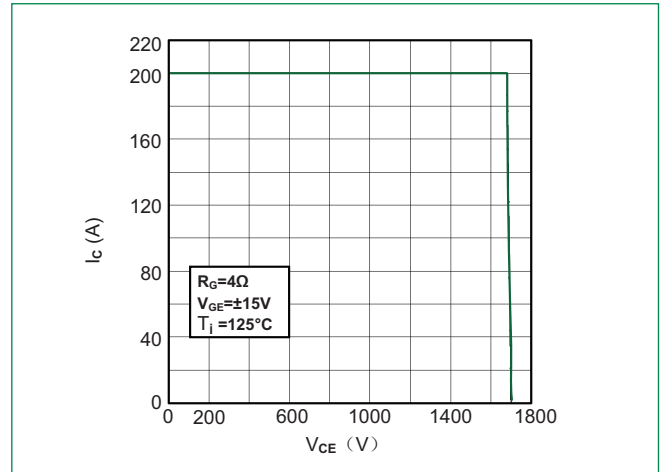

Figure 7: Diode Forward Characteristics

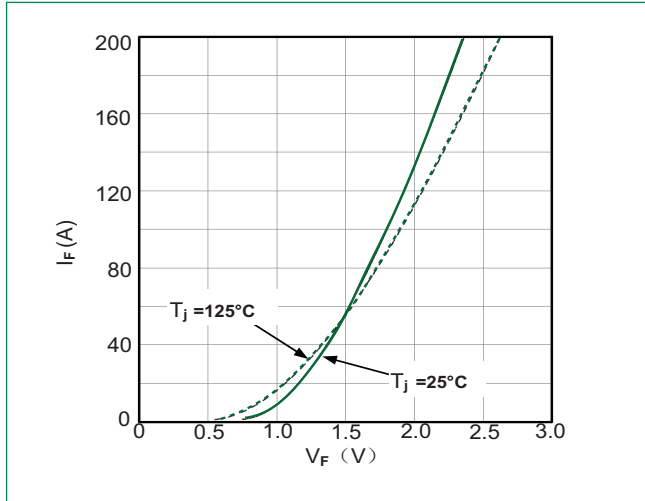

Figure 8: Switching Energy vs. Gate Resistor

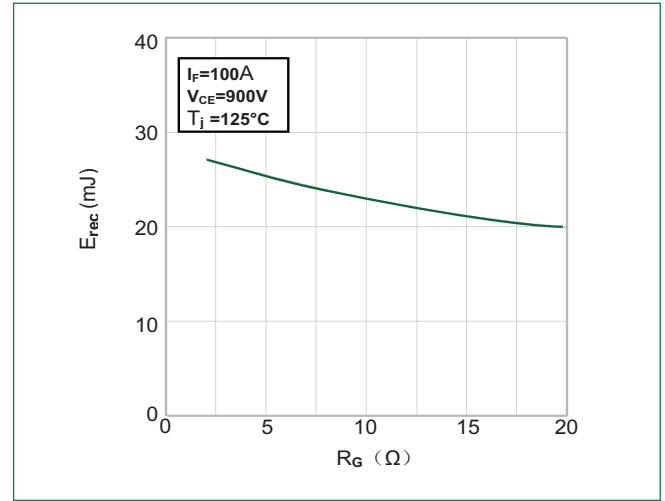

Figure 9: Switching Energy vs. Forward Current

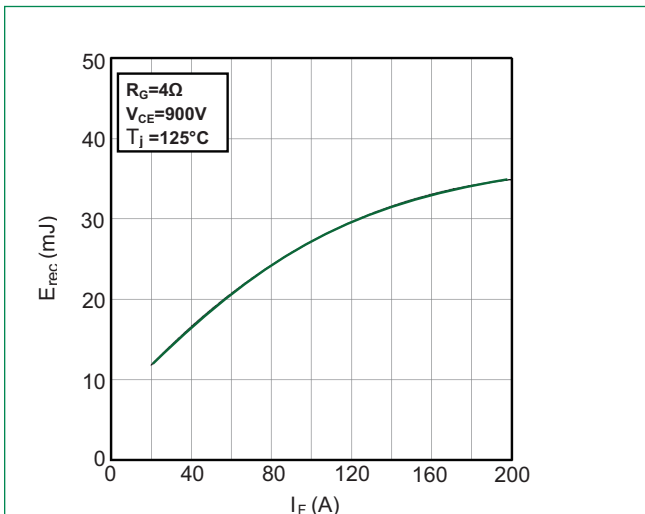
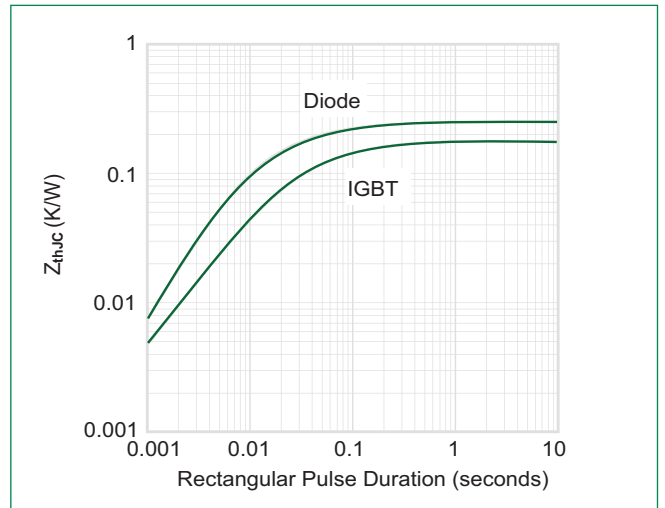
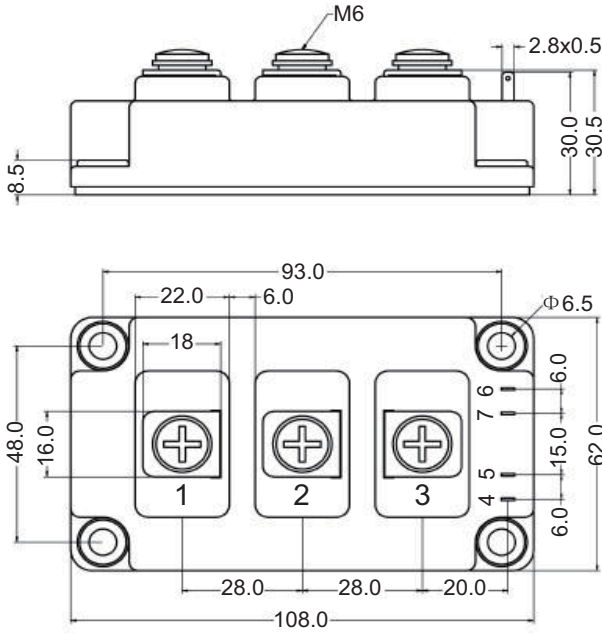

Figure 10: Transient Thermal Impedance of Diode and IGBT



Dimensions-Package D



Dimensions in mm

Circuit Diagram

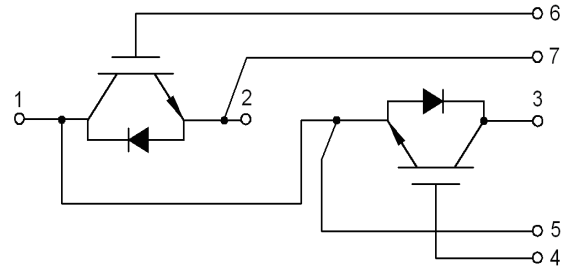

Packing Options

Part Number	Marking	Weight	Packing Mode	M.O.Q
MG17100D-BN4MM	MG17100D-BN4MM	320g	Bulk Pack	30

Part Numbering System

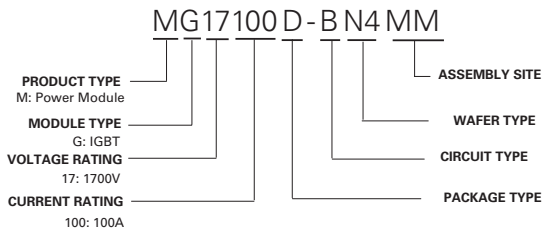

Part Marking System

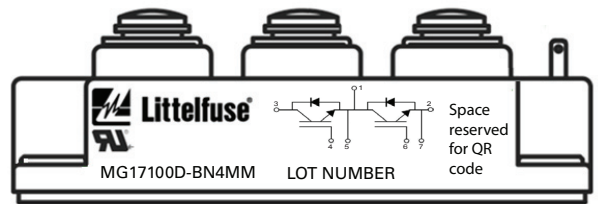

Данный компонент на территории Российской Федерации

Вы можете приобрести в компании MosChip.

Для оперативного оформления запроса Вам необходимо перейти по данной ссылке:

<http://moschip.ru/get-element>

Вы можете разместить у нас заказ для любого Вашего проекта, будь то серийное производство или разработка единичного прибора.

В нашем ассортименте представлены ведущие мировые производители активных и пассивных электронных компонентов.

Нашей специализацией является поставка электронной компонентной базы двойного назначения, продукции таких производителей как XILINX, Intel (ex.ALTERA), Vicor, Microchip, Texas Instruments, Analog Devices, Mini-Circuits, Amphenol, Glenair.

Сотрудничество с глобальными дистрибьюторами электронных компонентов, предоставляет возможность заказывать и получать с международных складов практически любой перечень компонентов в оптимальные для Вас сроки.

На всех этапах разработки и производства наши партнеры могут получить квалифицированную поддержку опытных инженеров.

Система менеджмента качества компании отвечает требованиям в соответствии с ГОСТ Р ИСО 9001, ГОСТ РВ 0015-002 и ЭС РД 009

Офис по работе с юридическими лицами:

105318, г.Москва, ул.Щербаковская д.3, офис 1107, 1118, ДЦ «Щербаковский»

Телефон: +7 495 668-12-70 (многоканальный)

Факс: +7 495 668-12-70 (доб.304)

E-mail: info@moschip.ru

Skype отдела продаж:

moschip.ru

moschip.ru_4

moschip.ru_6

moschip.ru_9