

DATA SHEET



BIPOLAR ANALOG INTEGRATED CIRCUIT

μ PC8211TK

SiGe LOW NOISE AMPLIFIER FOR GPS/MOBILE COMMUNICATIONS

DESCRIPTION

The μ PC8211TK is a silicon germanium (SiGe) monolithic integrated circuit designed as a low noise amplifier for GPS and mobile communications.

The package is 6-pin lead-less minimold, suitable for surface mount.

This IC is manufactured using our 50 GHz f_{max} UHS2 (Ultra High Speed Process) SiGe bipolar process.

★ FEATURES

- Low noise : NF = 1.3 dB TYP. @ $V_{CC} = 3.0$ V
- High gain : GP = 18.5 dB TYP. @ $V_{CC} = 3.0$ V
- Low current consumption : $I_{CC} = 3.5$ mA TYP. @ $V_{CC} = 3.0$ V
- Gain 1 dB compression output power : $P_{O(1\text{ dB})} = -6.0$ dBm @ $V_{CC} = 3.0$ V
- Built-in power-save function
- High-density surface mounting : 6-pin lead-less minimold package (1.5 × 1.3 × 0.55 mm)

APPLICATION

- Low noise amplifier for GPS and mobile communications

ORDERING INFORMATION

Part Number	Order Number	Package	Marking	Supplying Form
μ PC8211TK-E2	μ PC8211TK-E2-A	6-pin lead-less minimold (1511 PKG) (Pb-Free) ^{Note}	6G	• Embossed tape 8 mm wide • Pin 1, 6 face the perforation side of the tape • Qty 5 kpcs/reel

Note With regards to terminal solder (the solder contains lead) plated products (conventionally plated), contact your nearby sales office.

Remark To order evaluation samples, contact your nearby sales office.

Part number for sample order: μ PC8211TK-A

Caution Observe precautions when handling because these devices are sensitive to electrostatic discharge.

The information in this document is subject to change without notice. Before using this document, please confirm that this is the latest version.

PIN CONNECTIONS

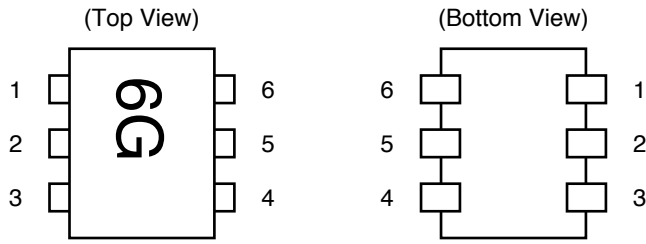

Pin No.	Pin Name
1	INPUT
2	GND
3	PS
4	OUTPUT
5	GND
6	V _{cc}

INTERNAL BLOCK DIAGRAM

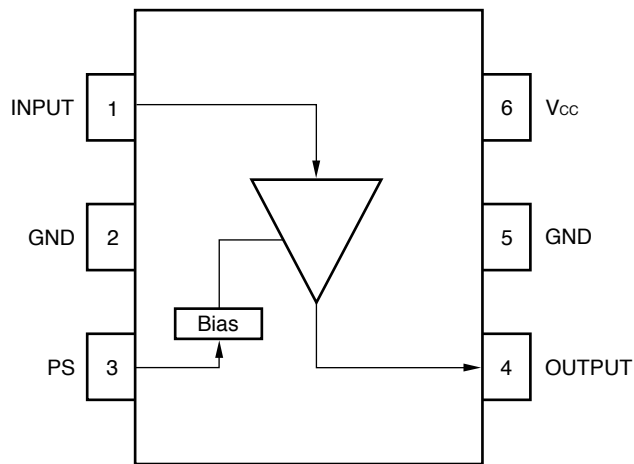

ABSOLUTE MAXIMUM RATINGS

Parameter	Symbol	Test Conditions	Ratings	Unit
Supply Voltage	V _{CC}	T _A = +25°C	4.0	V
Power-Saving Voltage	V _{PS}		-0.3 to V _{CC} +0.3	V
Power Dissipation of Package	P _D	T _A = +85°C Note	232	mW
Operating Ambient Temperature	T _A		-40 to +85	°C
Storage Temperature	T _{stg}		-55 to +150	°C
Input Power	P _{in}		+10	dBm

Note Mounted on double-side copper-clad 50 × 50 × 1.6 mm epoxy glass PWB

RECOMMENDED OPERATING RANGE

Parameter	Symbol	MIN.	TYP.	MAX.	Unit
Supply Voltage	V _{CC}	2.7	3.0	3.3	V
Operating Ambient Temperature	T _A	-25	+25	+85	°C
Operating Frequency Range	f _{in}	-	1 575	-	MHz

★ **ELECTRICAL CHARACTERISTICS** ($T_A = +25^\circ\text{C}$, $V_{CC} = 3.0\text{ V}$, $V_{PS} = 3.0\text{ V}$, $f_{in} = 1\ 575\text{ MHz}$, unless otherwise specified)

Parameter	Symbol	Test Conditions	MIN.	TYP.	MAX.	Unit
Circuit Current	I_{CC}	No Signal	2.5	3.5	4.5	mA
		At Power-Saving Mode	-	-	1	μA
Power Gain	G_P		15.5	18.5	21.5	dB
Noise Figure	NF		-	1.3	1.5	dB
Input 3rd Order Distortion Intercept Point	IIP_3		-	-12	-	dBm
Input Return Loss	RL_{in}		6.0	7.5	-	dB
Output Return Loss	RL_{out}		10	14.5	-	dB
Isolation	ISL		-	33.5	-	dB
Rising Voltage From Power-Saving Mode	V_{PSon}		2.2	-	-	V
Falling Voltage From Power-Saving Mode	V_{PSoff}		-	-	0.8	V
Gain Flatness	Flat	$f_{RF} = \pm 2.5\text{ MHz}$	-	-	0.5	dB
Gain 1 dB Compression Output Power	$P_{O(1\text{ dB})}$		-	-6.0	-	dBm
Output Power	P_O	$P_{in} = -10\text{ dBm}$	-1.5	+2.0	-	dBm

★ **TEST CIRCUIT**

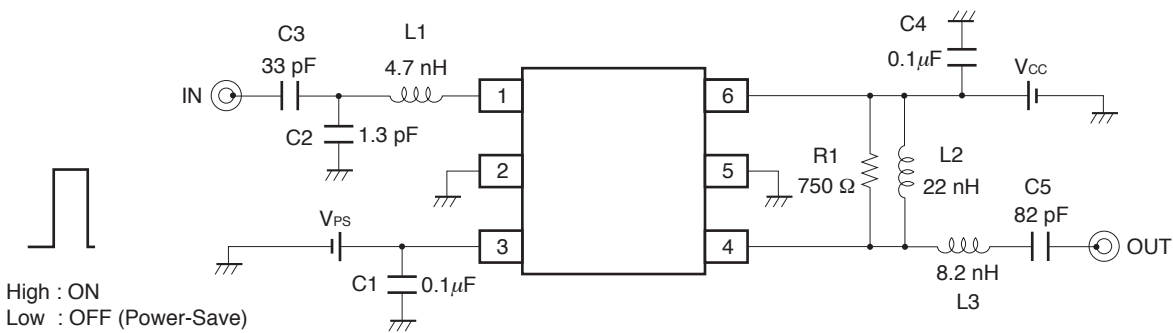

COMPONENTS OF TEST CIRCUIT FOR MEASURING ELECTRICAL CHARACTERISTICS

Symbol	Form	Rating	Part Number	Maker
C ₁ , C ₄	Chip Capacitor	0.1 μF	GRM36	Murata
C ₂	Chip Capacitor	1.3 pF	GRM36	Murata
C ₃	Chip Capacitor	33 pF	GRM36	Murata
C ₅	Chip Capacitor	82 pF	GRM36	Murata
R ₁	Resistor	750 Ω	RR0816	Susumu
L ₁	Inductor	4.7 nH	TFL0510	Susumu
L ₂	Inductor	22 nH	TFL0816 or TFL0510	Susumu
L ₃	Inductor	8.2 nH	TFL0510	Susumu

ILLUSTRATION OF THE TEST CIRCUIT ASSEMBLED ON EVALUATION BOARD

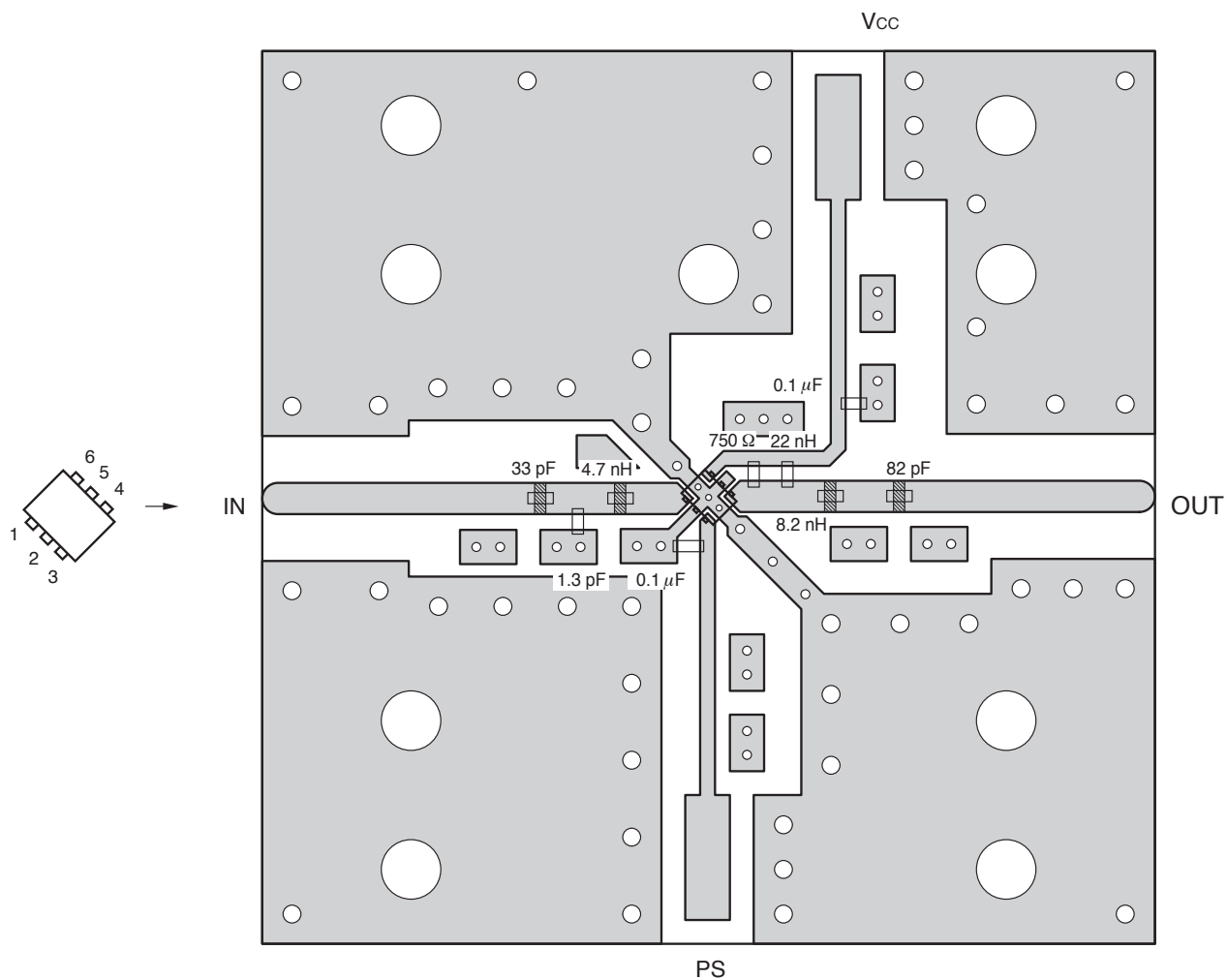

Notes

1. 30 × 30 × 0.51 mm double-side copper-clad hydrocarbon ceramic woven glass PWB (Rogers: R04003, $\epsilon_r = 3.38$).
2. Back side: GND pattern
3. Au plated on pattern
4. represents cutout
5. \circ : Through holes

TYPICAL CHARACTERISTICS ($T_A = +25^\circ\text{C}$, unless otherwise specified)

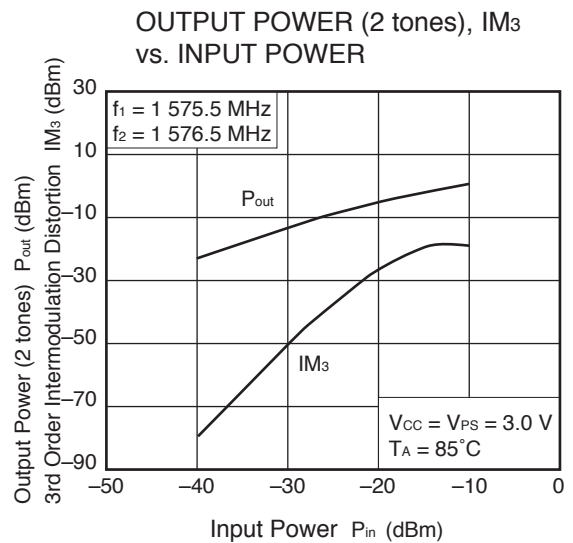
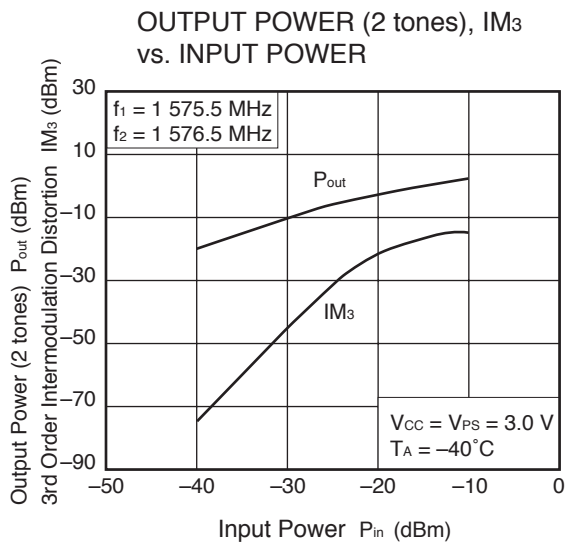
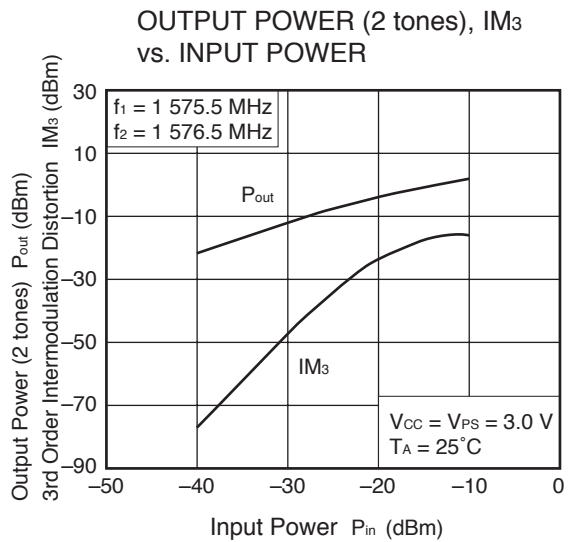
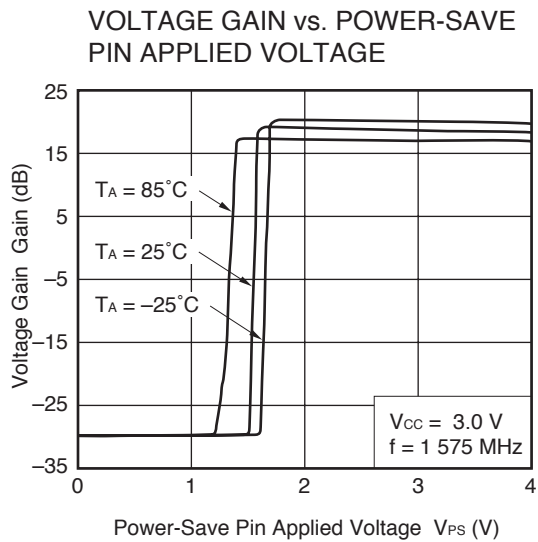
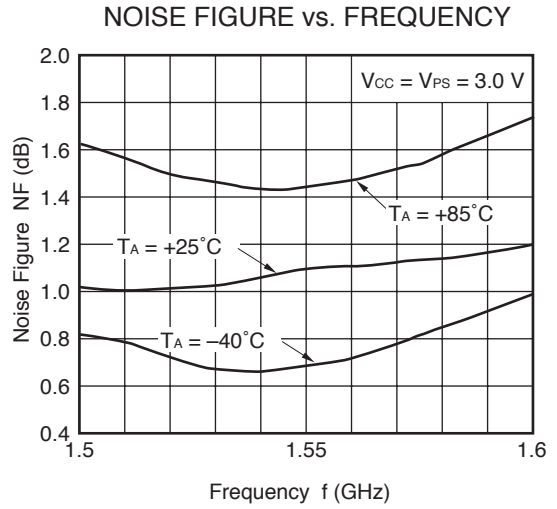
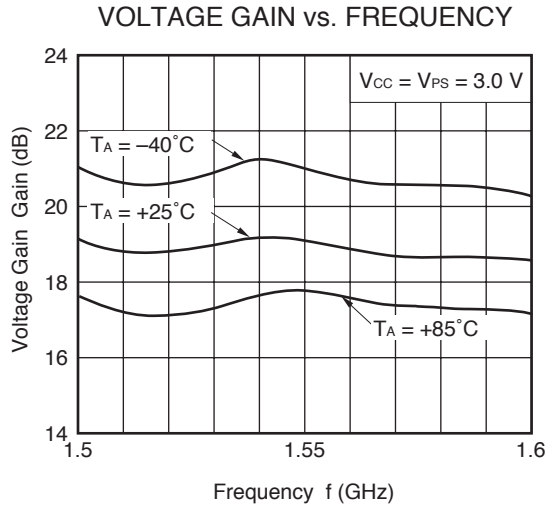

Remark The graphs indicate nominal characteristics.

S-PARAMETERS (T_A = +25°C, V_{CC} = V_{PS} = 3.0 V, monitored at connector on board)

S₁₁-FREQUENCY

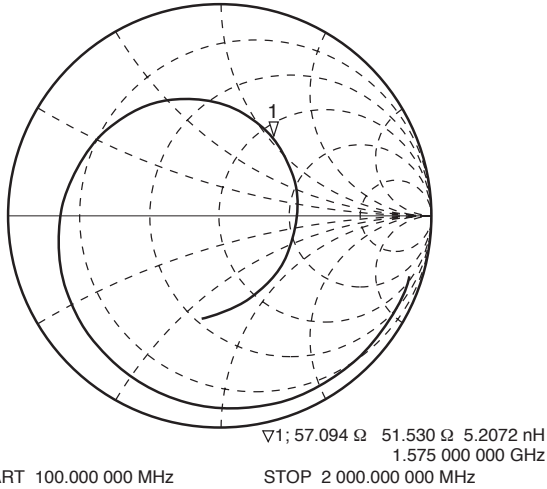

S₂₂-FREQUENCY

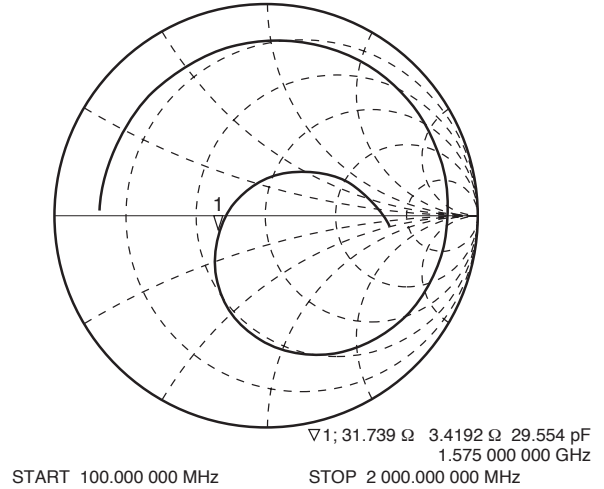

INPUT RETURN LOSS vs. FREQUENCY

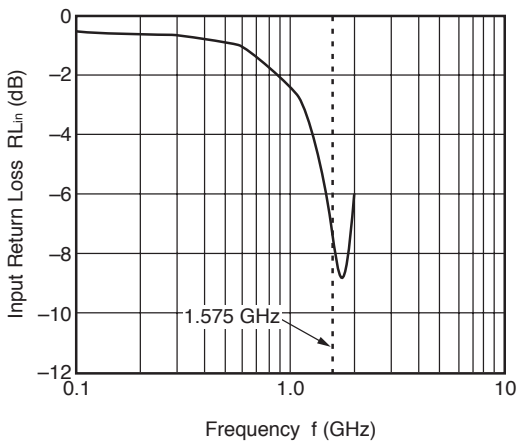

OUTPUT RETURN LOSS vs. FREQUENCY

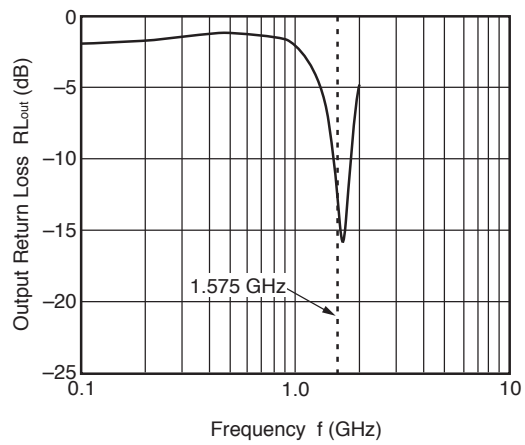

POWER GAIN vs. FREQUENCY

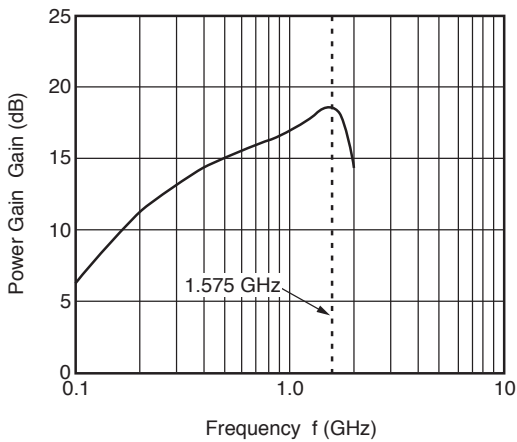

ISOLATION vs. FREQUENCY

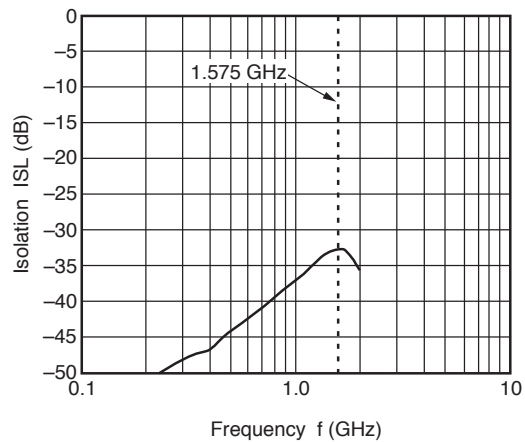

Remark The graphs indicate nominal characteristics.

PACKAGE DIMENSIONS

6-PIN LEAD-LESS MINIMOLD (1511 PKG) (UNIT: mm)

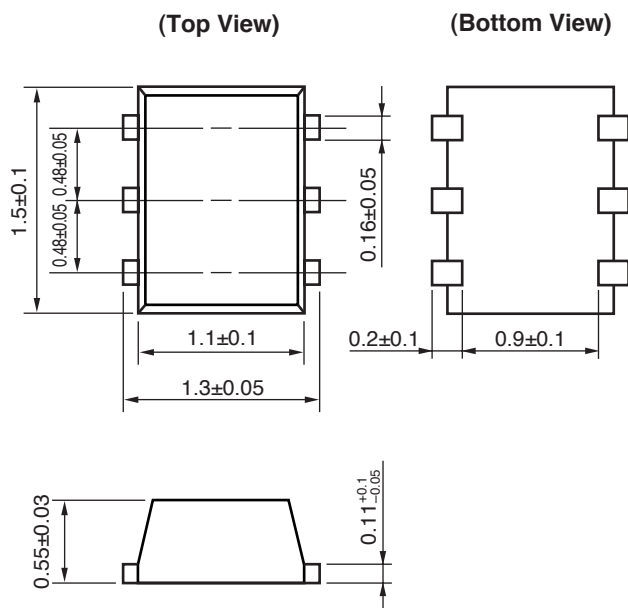

Remark () : Reference value

NOTES ON CORRECT USE

- (1) Observe precautions for handling because of electro-static sensitive devices.
- (2) Form a ground pattern as widely as possible to minimize ground impedance (to prevent undesired oscillation).
All the ground terminals must be connected together with wide ground pattern to decrease impedance difference.
- (3) The bypass capacitor should be attached to Vcc line.

RECOMMENDED SOLDERING CONDITIONS

This product should be soldered and mounted under the following recommended conditions. For soldering methods and conditions other than those recommended below, contact your nearby sales office.

Soldering Method	Soldering Conditions	Condition Symbol
Infrared Reflow	Peak temperature (package surface temperature) : 260°C or below Time at peak temperature : 10 seconds or less Time at temperature of 220°C or higher : 60 seconds or less Preheating time at 120 to 180°C : 120±30 seconds Maximum number of reflow processes : 3 times Maximum chlorine content of rosin flux (% mass) : 0.2%(Wt.) or below	IR260
Wave Soldering	Peak temperature (molten solder temperature) : 260°C or below Time at peak temperature : 10 seconds or less Preheating temperature (package surface temperature) : 120°C or below Maximum number of flow processes : 1 time Maximum chlorine content of rosin flux (% mass) : 0.2%(Wt.) or below	WS260
Partial Heating	Peak temperature (terminal temperature) : 350°C or below Soldering time (per side of device) : 3 seconds or less Maximum chlorine content of rosin flux (% mass) : 0.2%(Wt.) or below	HS350

Caution Do not use different soldering methods together (except for partial heating).

Данный компонент на территории Российской Федерации

Вы можете приобрести в компании MosChip.

Для оперативного оформления запроса Вам необходимо перейти по данной ссылке:

<http://moschip.ru/get-element>

Вы можете разместить у нас заказ для любого Вашего проекта, будь то серийное производство или разработка единичного прибора.

В нашем ассортименте представлены ведущие мировые производители активных и пассивных электронных компонентов.

Нашей специализацией является поставка электронной компонентной базы двойного назначения, продукции таких производителей как XILINX, Intel (ex.ALTERA), Vicor, Microchip, Texas Instruments, Analog Devices, Mini-Circuits, Amphenol, Glenair.

Сотрудничество с глобальными дистрибьюторами электронных компонентов, предоставляет возможность заказывать и получать с международных складов практически любой перечень компонентов в оптимальные для Вас сроки.

На всех этапах разработки и производства наши партнеры могут получить квалифицированную поддержку опытных инженеров.

Система менеджмента качества компании отвечает требованиям в соответствии с ГОСТ Р ИСО 9001, ГОСТ РВ 0015-002 и ЭС РД 009

Офис по работе с юридическими лицами:

105318, г.Москва, ул.Щербаковская д.3, офис 1107, 1118, ДЦ «Щербаковский»

Телефон: +7 495 668-12-70 (многоканальный)

Факс: +7 495 668-12-70 (доб.304)

E-mail: info@moschip.ru

Skype отдела продаж:

moschip.ru

moschip.ru_4

moschip.ru_6

moschip.ru_9