

# NCP690, NCP691, NCP692

## 1 A, Low $I_{GND}$ , Very Low Dropout Regulator (VLDO) with/without Enable

The NCP690, NCP691, NCP692 CMOS LDO family provides 1 A of output current with enhanced ESD in either fixed voltage options or an adjustable output voltage from 5.0 V down to 1.25 V. This device is designed for space constrained and portable battery powered applications and offer additional features such as high PSRR, low Quiescent and Ground current consumption, low noise operation, short circuit and thermal protection. The device is designed to be used with low cost ceramic capacitors and is packaged in the 6-Lead DFN3x3 package.

### Features

- Output Voltage Options: Adjustable, 1.5 V, 1.8 V, 2.5 V, 3.3 V, 5.0 V – Other Options Possible
- Adjustable Output by External Resistors from 5.0 V down to 1.25 V
- Guaranteed 1 A Output Current
- $\pm 1.5\%$  Output Voltage Tolerance over All Operating Conditions (Adjustable)
- $\pm 2\%$  Output Voltage Tolerance over All Operating Conditions (Fixed)
- Typical Noise Voltage of 50  $\mu$ Vrms without a Bypass Capacitor
- Typical Dropout Voltage of 190 mV at 1 A ( $V_{out} = 2.5$  V,  $T_J = 25^\circ$ C)
- Active Output Discharge
- Active Low Enable Pin (NCP691 Device)
- Active High Enable Pin (NCP692 device)
- Enhanced ESD: 4 kV and 200 V
- These are Pb-Free Devices

### Applications

- Laptops and PCI Cards
- Modem Banks and Telecom Boards
- DSP, FPGA, Microprocessor Boards
- Portable, Battery-Power Applications
- Hard Disk Drives



**ON Semiconductor®**

<http://onsemi.com>



**DFN6 3x3  
MN SUFFIX  
CASE 506AH**

### MARKING DIAGRAM

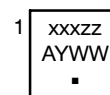

**Pb-Free**

xxx	= 690, 691, 692
zz	= 15, 18, 25, 33, 50, AD
A	= Assembly Location
Y	= Year
WW	= Work Week
▪	= Pb-Free Package

### PIN ASSIGNMENT

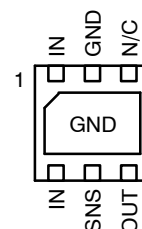

**NCP690 – 6 PIN DFN**  
Fixed Version  
(Bottom View)

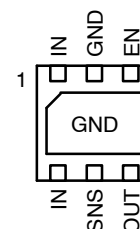

**NCP691, NCP692 – 6 PIN DFN**  
Fixed Version  
(Bottom View)

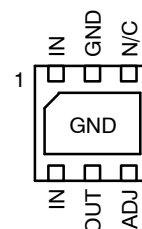

**NCP690 – 6 PIN DFN**  
Adjustable Version  
(Bottom View)

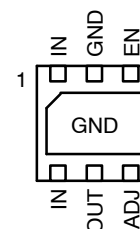

**NCP691, NCP692 – 6 PIN DFN**  
Adjustable Version  
(Bottom View)

### ORDERING INFORMATION

See detailed ordering and shipping information in the package dimensions section on page 13 of this data sheet.

## NCP690, NCP691, NCP692

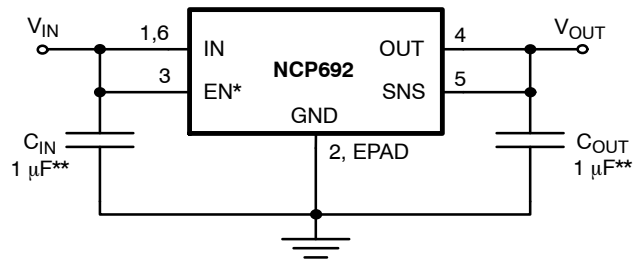

Note: \* NCP692 device has EN active high  
 \*\* Minimum value required for stability

**Figure 1. NCP692 Typical Application Circuit for Fixed Version**  
 (Output voltage versions: 1.5 V, 1.8 V, 2.5 V, 5.0 V)

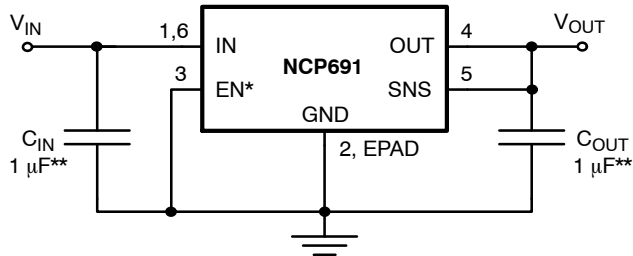

Note: \* NCP691 device has EN active low  
 \*\* Minimum value required for stability

**Figure 2. NCP691 Typical Application Circuit for Fixed Version**  
 (Output voltage versions: 1.5 V, 1.8 V, 2.5 V, 5.0 V)

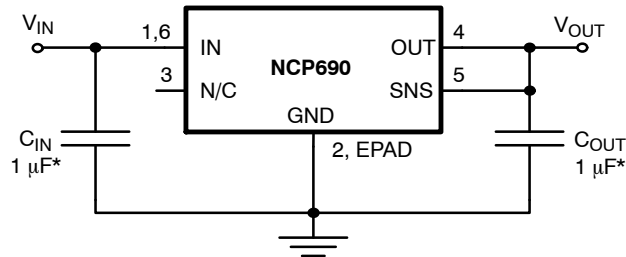

Note: \* Minimum value required for stability

**Figure 3. NCP690 Typical Application Circuit for Fixed Version**  
 (Output voltage versions: 1.5 V, 1.8 V, 2.5 V, 5.0 V)

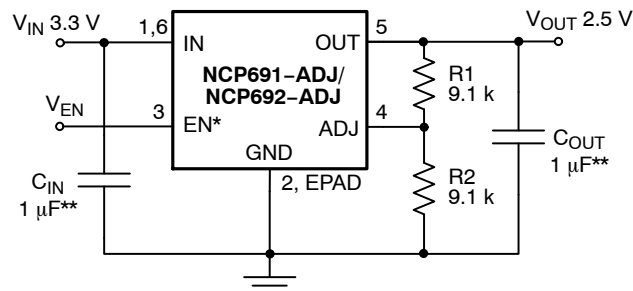

Note: \* NCP691-ADJ device has EN active low and  
 NCP692-ADJ device has EN active high  
 \*\* Minimum value required for stability

**Figure 4. NCP692 Typical Application Circuit for Adjustable Version**  
 (Adjustable version for  $1.25 \text{ V} < V_{\text{OUT}} \leq 5.0 \text{ V}$ )

## NCP690, NCP691, NCP692

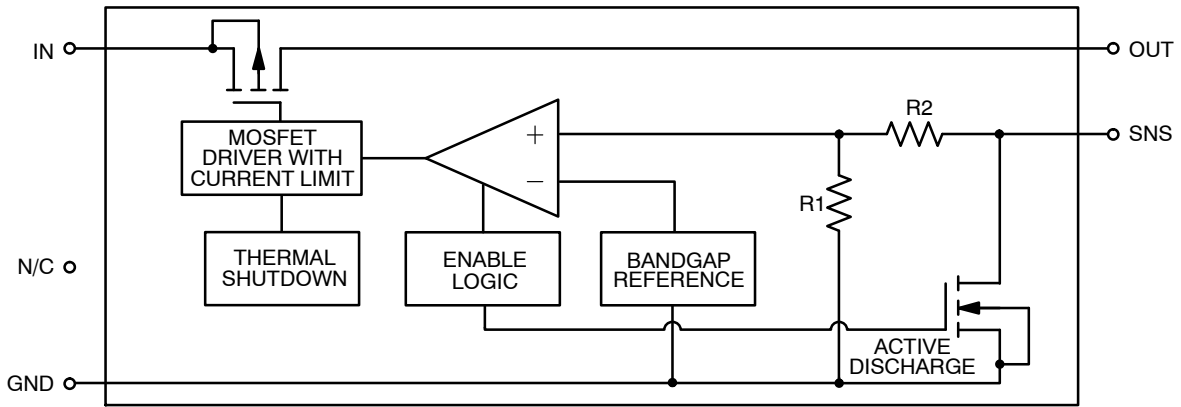

**Figure 5. NCP690 Block Diagram (Fixed Version)**

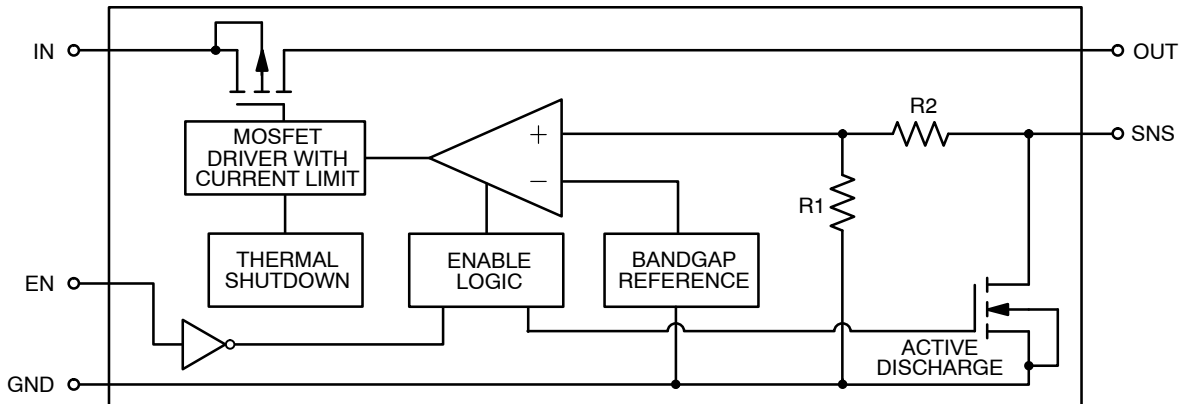

**Figure 6. NCP691 Block Diagram (Fixed Version)**

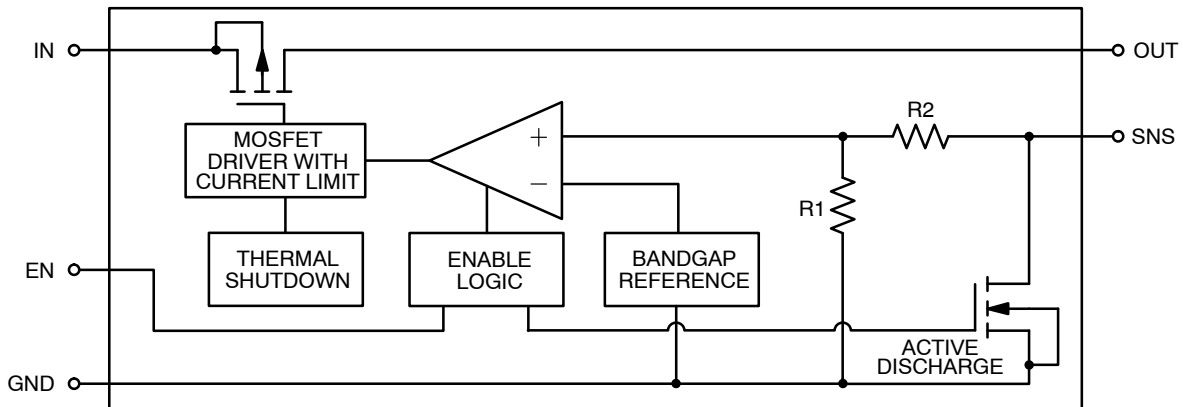
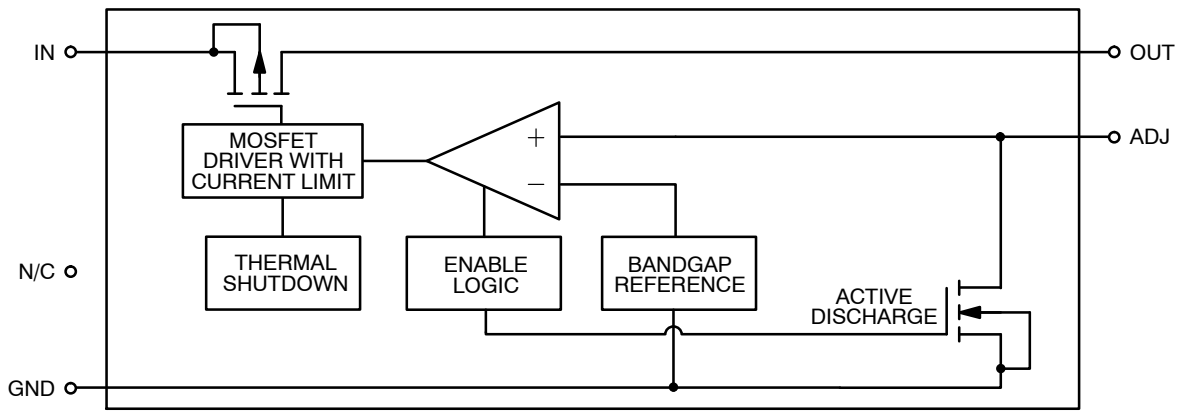

**Figure 7. NCP692 Block Diagram (Fixed Version)**

**Table 1. PIN FUNCTION DESCRIPTION FOR FIXED VERSION**

Pin No.	Pin Name	Description
1, 6	IN	Voltage inputs which supplies the current to the regulator. Both of these pins should be connected together for full output current capability
2	GND	Power supply ground of the regulator. Connected to the die through the lead frame. Soldered to the copper plane allows for effective heat removal.
3	EN	For NCP691 and NCP692 this pin functions as Enable Active Low and Enable Active High respectively. For NCP690 this pin has no special meaning and should be left disconnected.
4	OUT	Regulated output voltage
5	SNS	Sense input. This pin should be connected directly to OUT pin.

## NCP690, NCP691, NCP692



**Figure 8. NCP690 Block Diagram (Adjustable Version)**

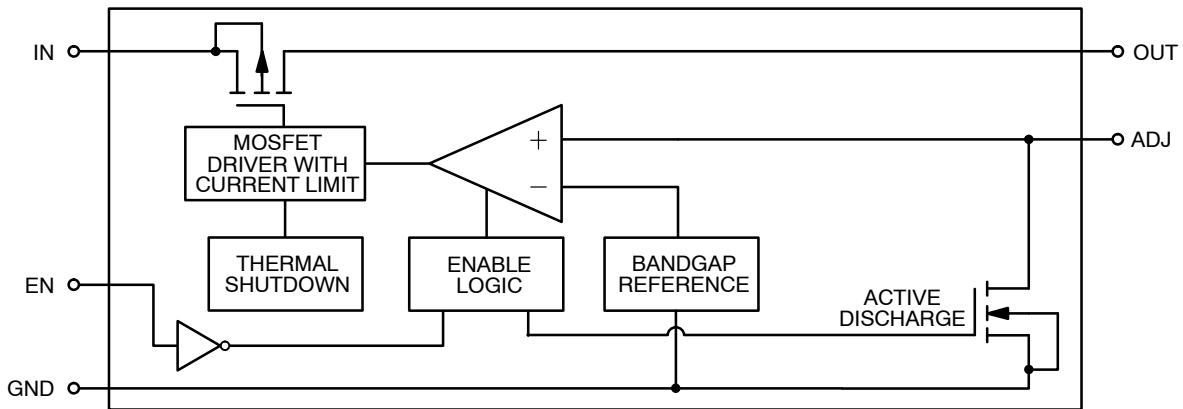

**Figure 9. NCP691 Block Diagram (Adjustable Version)**

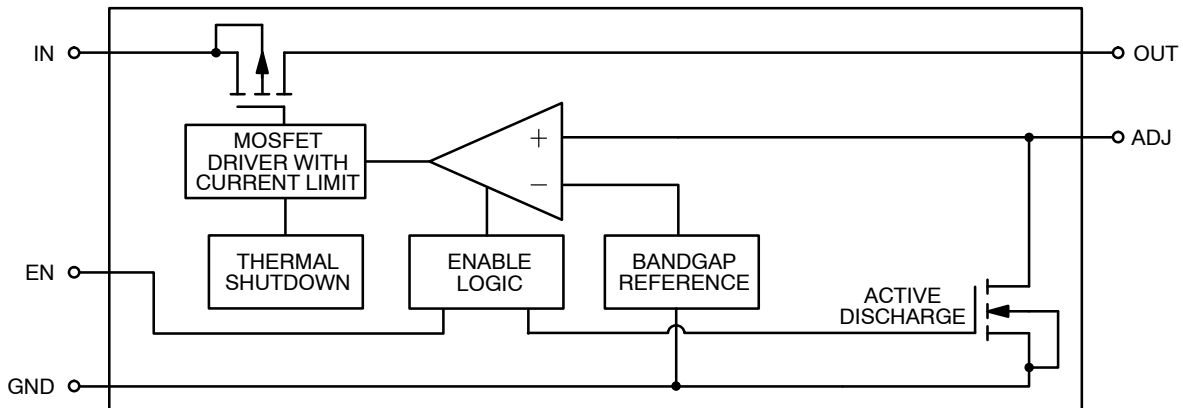

**Figure 10. NCP692 Block Diagram (Adjustable Version)**

**Table 2. PIN FUNCTION DESCRIPTION FOR ADJUSTABLE VERSION**

Pin No.	Pin Name	Description
1, 6	IN	Voltage inputs which supplies the current to the regulator. Both of these pins should be connected together for full output current capability
2	GND	Power supply ground of the regulator. Connected to the die through the lead frame. Soldered to the copper plane allows for effective heat removal.
3	EN	For NCP691 and NCP692 this pin functions as Enable Active Low and Enable Active High respectively. For NCP690 this pin has no special meaning and should be left disconnected.
4	ADJ	Feedback input. Connect to middle point of resistor divider for Adjustable version.
5	OUT	Regulated output voltage

# NCP690, NCP691, NCP692

**Table 3. ABSOLUTE MAXIMUM RATINGS**

Rating		Symbol	Value	Unit
Input Voltage (Note 1)		$V_{IN}$	-0.3 to 6.5	V
Chip Enable Voltage		$V_{EN}$	-0.3 to 6.5	V
Output Voltage		$V_{OUT}$	-0.3 to 6.5	V
Output Voltage / Sense Input, (SNS pin)		$V_{SNS}$	-0.3 to 6.5	V
Electrostatic Discharge	Human Body Model	ESD	4000	V
	Machine Model		200	
Maximum Junction Temperature		$T_{J\_MAX}$	150	°C
Storage Temperature Range		$T_{STG}$	-65 to 150	°C

Stresses exceeding Maximum Ratings may damage the device. Maximum Ratings are stress ratings only. Functional operation above the Recommended Operating Conditions is not implied. Extended exposure to stresses above the Recommended Operating Conditions may affect device reliability.

NOTE: This device series contains ESD protection and exceeds the following tests:  
 ESD HBM tested per JEDEC standard: JESD22-A114  
 ESD MM tested per JEDEC standard: JESD22-A115  
 Latch-up Current Maximum Rating:  $\leq 150$  mA per JEDEC standard: JESD78

**Table 4. PACKAGE THERMAL CHARACTERISTICS**

Rating		Condition	Symbol	Value	Unit
Thermal Resistance, Junction-to-Ambient (Note 2)	DFN6 3x3, 1 oz Cu	64 mm <sup>2</sup> Cu 645 mm <sup>2</sup> Cu	$R_{\theta JA}$	169 70	°C/W
	DFN6 3x3, 2 oz Cu	64 mm <sup>2</sup> Cu 645 mm <sup>2</sup> Cu	$R_{\theta JA}$	151 62	°C/W
Thermal Resistance, Junction-to-Pin			$R_{\theta JL}$	15	°C/W

**Table 5. OPERATING RANGES**

Rating	Symbol	Value	Unit
Operating Input Voltage (Notes 3 and 4)	$V_{IN}$	1.5 to 6.0	V
Operating Junction Temperature Range	$T_J$	-40 to 125	°C
Operating Ambient Temperature Range	$T_A$	-40 to 85	°C

1. Minimum  $V_{IN} = (V_{OUT} + V_{DO})$  or 1.5 V, whichever is higher.
2. Soldered on FR4 copper area, please refer to Applications Section for Safe Operating Area.
3. Minimum  $V_{IN} = (V_{OUT} + V_{DO})$  or 1.5 V, whichever is higher.
4. Refer to Electrical Characteristics and Application Information for Safe Operating Area.

## NCP690, NCP691, NCP692

**Table 6. ELECTRICAL CHARACTERISTICS**  $V_{IN} = (V_{OUT} + 1\text{ V})$ ,  $V_{EN} = V_{IN}$ ,  $I_{OUT} = 1\text{ mA}$ ,  $C_{IN} = 10\text{ }\mu\text{F}$ ,  $C_{OUT} = 10\text{ }\mu\text{F}$ , for typical values  $T_J = 25^\circ\text{C}$ , for Min/Max values  $T_J = -40^\circ\text{C}$  to  $125^\circ\text{C}$ ; unless otherwise noted. (Note 5)

Parameter	Test Conditions		Symbol	Min	Typ	Max	Unit
Output voltage (Adjustable Version)	$V_{IN} = 1.75\text{ V}$ to $6.0\text{ V}$ $I_{OUT} = 100\text{ }\mu\text{A}$ to $1\text{ A}$		$V_{OUT}$	1.231 (-1.5%)	1.250	1.269 (+1.5%)	V
Output voltage (Fixed Version)	$V_{IN} = (V_{OUT} + 1\text{ V})$ to $6.0\text{ V}$ $I_{OUT} = 100\text{ }\mu\text{A}$ to $1\text{ A}$	$V_{OUT} = 1.5\text{ V}$ $V_{OUT} = 1.8\text{ V}$ $V_{OUT} = 2.5\text{ V}$ $V_{OUT} = 3.3\text{ V}$ $V_{OUT} = 5.0\text{ V}$	$V_{OUT}$	1.470 1.764 2.450 3.234 4.900 (-2%)	1.5 1.8 2.5 3.3 5.0	1.530 1.836 2.550 3.366 5.100 (+2%)	V
Line regulation	$V_{IN} = (V_{OUT} + 1\text{ V})$ to $6.0\text{ V}$		$Reg_{LINE}$	-	3.2	8	mV
Load regulation	$I_{OUT} = 100\text{ }\mu\text{A}$ to $1\text{ A}$	$V_{OUT} = 1.5\text{ V}$ $V_{OUT} = 1.8\text{ V}$ $V_{OUT} = 2.5\text{ V}$ $V_{OUT} = 3.3\text{ V}$ $V_{OUT} = 5.0\text{ V}$	$Reg_{LOAD}$	- - - - -	10 10 10 10 10	30 30 35 35 40	mV
Dropout voltage (Adjustable Version, Note 6)	$V_{DO} = V_{IN} - V_{OUT}$ $V_{OUT} = 1.25\text{ V}$ $I_{OUT} = 1\text{ A}$		$V_{DO}$	-	450	470	mV
Dropout voltage (Fixed Version, Note 9)	$I_{OUT} = 1\text{ A}$	$V_{OUT} = 1.5\text{ V}$ $V_{OUT} = 1.8\text{ V}$ $V_{OUT} = 2.5\text{ V}$ $V_{OUT} = 3.3\text{ V}$ $V_{OUT} = 5.0\text{ V}$	$V_{DO}$	- - - - -	290 240 190 180 120	410 380 300 250 210	mV
Ground current	$V_{IN} = V_{OUT} + 1\text{ V}$ , $V_{OUT} = 1.5\text{ V}, 1.8\text{ V},$ $2.5\text{ V}, 3.3\text{ V}$	$I_{OUT} = 1\text{ A}$ $I_{OUT} = 10\text{ }\mu\text{A}$ $I_{OUT} = 100\text{ }\mu\text{A}$	$I_{GND}$	- - -	145 145 145	200 200 200	$\mu\text{A}$
	$V_{IN} = V_{OUT} + 1\text{ V}$ , $V_{OUT} = 5.0\text{ V}$	$I_{OUT} = 1\text{ A}$ $I_{OUT} = 10\text{ }\mu\text{A}$ $I_{OUT} = 100\text{ }\mu\text{A}$		- - -	145 145 145	240 240 240	
Disable current (NCP692 only, Notes 5 and 7)	$V_{EN} < 0.4\text{ V}$		$I_{DIS}$	-	0.1	1	$\mu\text{A}$
Output Current Limit	$V_{IN} = V_{OUT} + 1\text{ V}$ , $V_{OUT} = 85\% V_{OUT\_NOM}$		$I_{LIM}$	1.1	1.6	2.4	A
Short Circuit Current	$V_{OUT} = 0\text{ V}$		$I_{SC}$	1.2	-	-	A
Enable High Level Threshold	$V_{EN}$ increasing from low to high logic level		$V_{EN\_HI}$	0.9	-	-	V
Enable Low Level Threshold (NCP691 and NCP692)	$V_{EN}$ decreasing from high to low logic level		$V_{EN\_LO}$	-	-	0.4	V
Enable Input Current (Enable Active Low) (NCP691 only, Note 8)	$V_{EN} = 0.9\text{ V}$ to $V_{IN}$		$I_{EN\_HI}$	-	0.01	250	nA
Enable Input Current (NCP692 only, Note 8)	$V_{EN} = 0\text{ V}$		$I_{EN\_LO}$	-	0.01	100	nA
Feedback Current	$V_{FB} = 1.25$ (Adjustable version only)		$I_{IFB}$	-	210	320	nA
Turn-on Time (Note 8)	$V_{IN} = 0\text{ V}$ to $(V_{OUT} + 1\text{ V})$ or $1.75\text{ V}$ $V_{OUT} = 0\text{ V}$ to $90\% V_{OUT\_NOM}$		$t_{ON}$	-	50	-	$\mu\text{s}$

5. Performance guaranteed over the indicated operating temperature range by design and/or characterization tested at  $T_J = T_A = 25^\circ\text{C}$ . Low duty cycle pulse techniques are used during testing to maintain the junction temperature as close to ambient as possible.
6. Maximum dropout voltage is limited by minimum input voltage.  $V_{IN} = 1.7\text{ V}$  recommended for guaranteed operation at maximum output current.
7. Refer to the Applications Information Section.
8. Values based on design and/or characterization.
9. Dropout voltage is defined as the differential voltage between  $V_{OUT}$  and  $V_{IN}$ , when  $V_{OUT}$  drops 100 mV below its nominal value.

# NCP690, NCP691, NCP692

**Table 6. ELECTRICAL CHARACTERISTICS**  $V_{IN} = (V_{OUT} + 1\text{ V})$ ,  $V_{EN} = V_{IN}$ ,  $I_{OUT} = 1\text{ mA}$ ,  $C_{IN} = 10\text{ }\mu\text{F}$ ,  $C_{OUT} = 10\text{ }\mu\text{F}$ , for typical values  $T_J = 25^\circ\text{C}$ , for Min/Max values  $T_J = -40^\circ\text{C}$  to  $125^\circ\text{C}$ ; unless otherwise noted. (Note 5) (continued)

Parameter	Test Conditions		Symbol	Min	Typ	Max	Unit
Power supply ripple rejection (Note 8)	$V_{OUT} = 1.25\text{ V}$ $V_{IN} = V_{OUT} + 1\text{ V}$ , with $V_{PP} = 0.5\text{ V}$ , $C_{OUT} = 1\text{ }\mu\text{F}$	$f = 120\text{ Hz}$ $f = 1\text{ kHz}$ $f = 10\text{ kHz}$	PSRR	-	62	-	dB
Output noise voltage (Note 8)	$BW = 200\text{ Hz to }100\text{ kHz}$ , $C_{IN} = 1\text{ }\mu\text{F}$ , $C_{OUT} = 10\text{ }\mu\text{F}$ , $T_A = 25^\circ\text{C}$		$V_N$	-	50	-	$\mu\text{V}_{\text{rms}}$
Thermal Shutdown Temperature (Note 8)			$T_{SD}$	-	175	-	$^\circ\text{C}$
Thermal Shutdown Hysteresis (Note 8)			$T_{SH}$	-	10	-	$^\circ\text{C}$

5. Performance guaranteed over the indicated operating temperature range by design and/or characterization tested at  $T_J = T_A = 25^\circ\text{C}$ . Low duty cycle pulse techniques are used during testing to maintain the junction temperature as close to ambient as possible.
6. Maximum dropout voltage is limited by minimum input voltage.  $V_{IN} = 1.7\text{ V}$  recommended for guaranteed operation at maximum output current.
7. Refer to the Applications Information Section.
8. Values based on design and/or characterization.
9. Dropout voltage is defined as the differential voltage between  $V_{OUT}$  and  $V_{IN}$ , when  $V_{OUT}$  drops 100 mV below its nominal value.

## TYPICAL CHARACTERISTICS

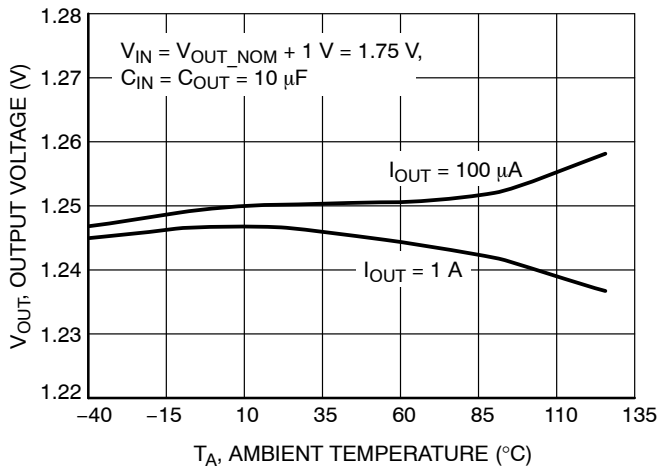

**Figure 11. Output Voltage vs. Temperature**  
( $V_{out} = 1.25\text{ V}$ )

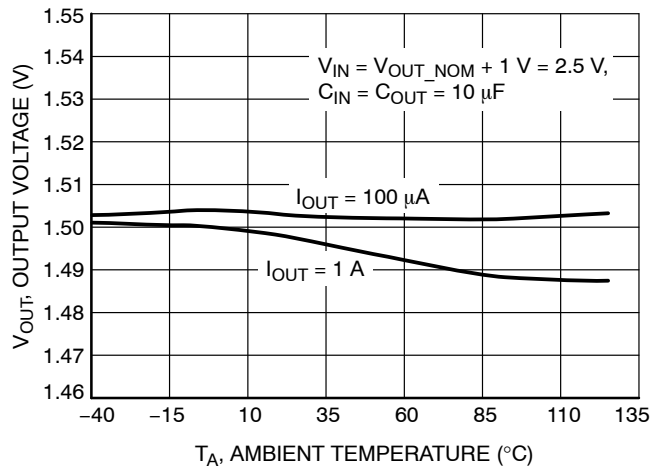

**Figure 12. Output Voltage vs. Temperature**  
( $V_{out} = 1.5\text{ V}$ )

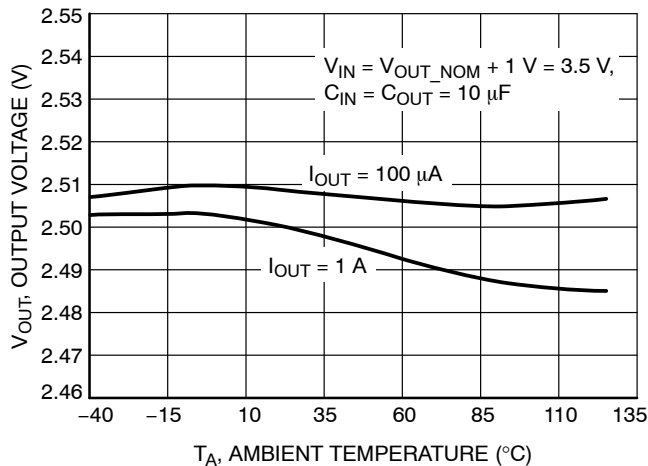

**Figure 13. Output Voltage vs. Temperature**  
( $V_{out} = 2.5\text{ V}$ )

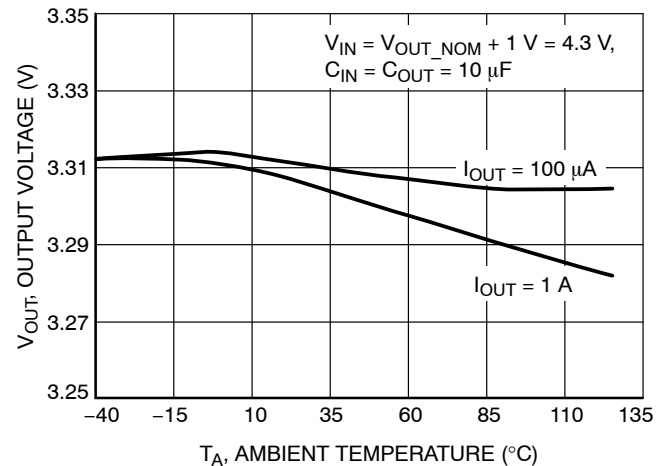

**Figure 14. Output Voltage vs. Temperature**  
( $V_{out} = 3.3\text{ V}$ )

# NCP690, NCP691, NCP692

## TYPICAL CHARACTERISTICS

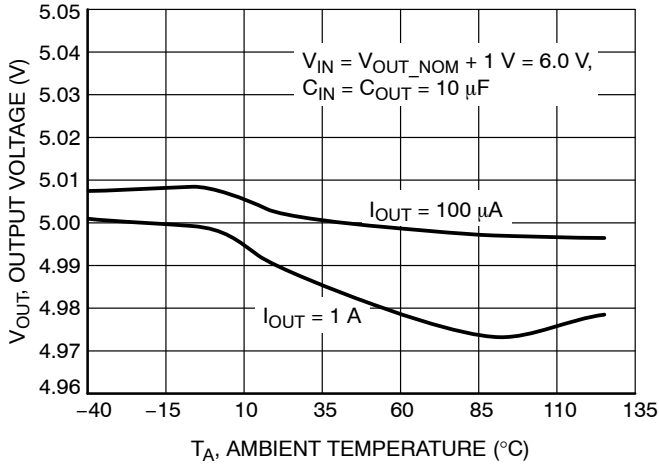

**Figure 15. Output Voltage vs. Temperature**  
( $V_{out} = 5.0\text{ V}$ )

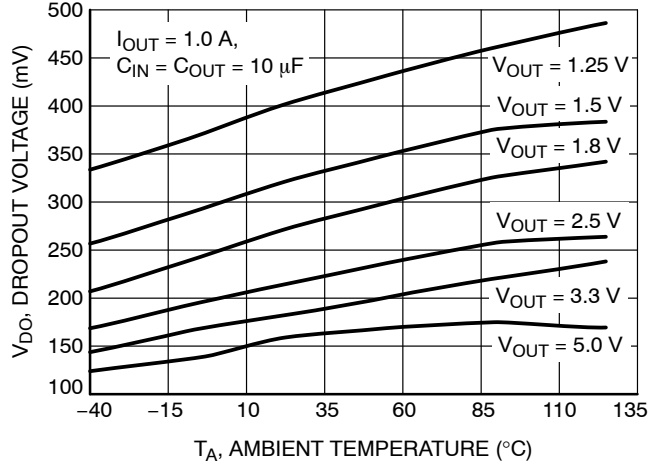

**Figure 16. Dropout Voltage vs. Temperature**  
( $V_{out} = 1.25\text{ V}, 1.5\text{ V}, 1.8\text{ V}, 2.5\text{ V}, 3.3\text{ V}, 5.0\text{ V}$ )

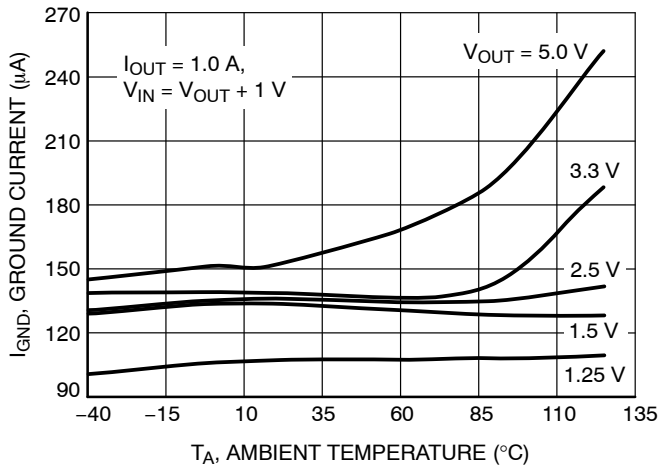

**Figure 17. Ground Current vs. Temperature**  
( $V_{out} = 1.25\text{ V}, 1.5\text{ V}, 2.5\text{ V}, 3.3\text{ V}, 5.0\text{ V}$ )

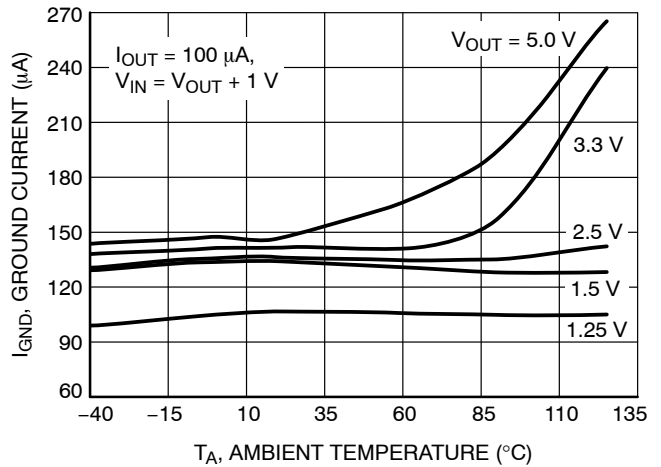

**Figure 18. Ground Current vs. Temperature**  
( $V_{out} = 1.25\text{ V}, 1.5\text{ V}, 2.5\text{ V}, 3.3\text{ V}, 5.0\text{ V}$ )

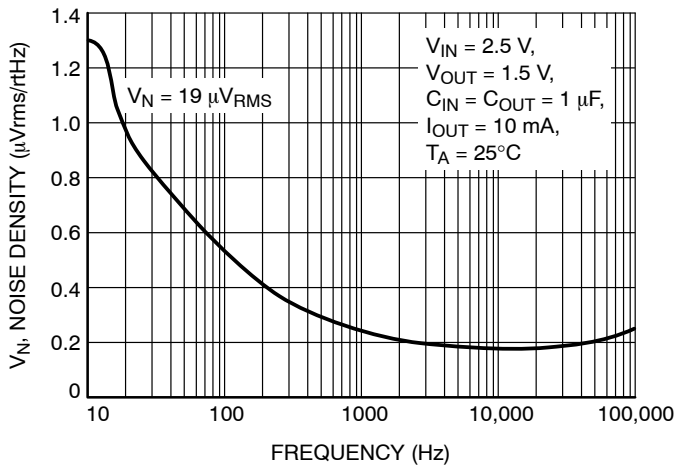

**Figure 19. Noise Density vs. Frequency**  
( $V_{out} = 1.5\text{ V}$ )

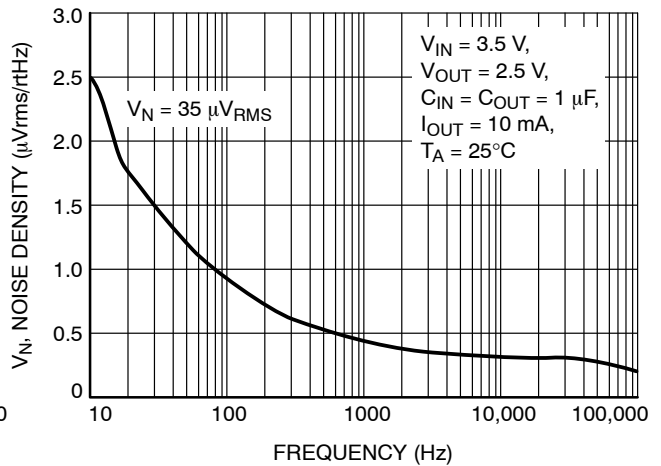
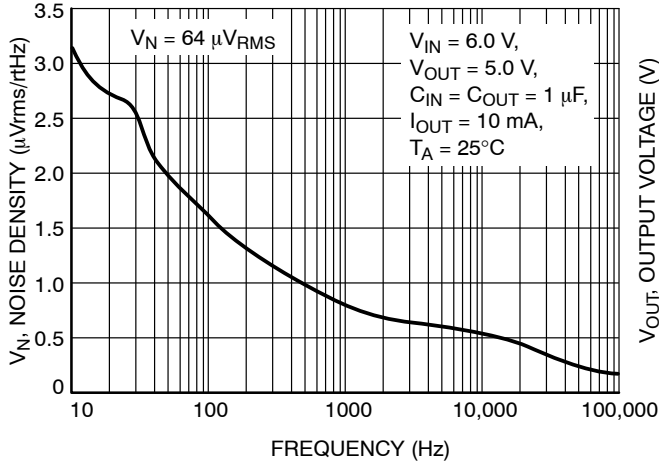

**Figure 20. Noise Density vs. Frequency**  
( $V_{out} = 2.5\text{ V}$ )



# NCP690, NCP691, NCP692

## TYPICAL CHARACTERISTICS



**Figure 21. Noise Density vs. Frequency**  
( $V_{out} = 5.0\text{ V}$ )

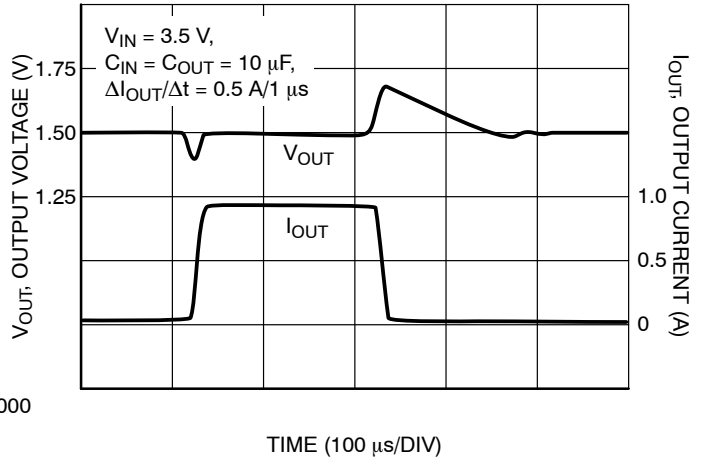

**Figure 22. Load Transient**  
( $V_{out} = 1.5\text{ V}$ )

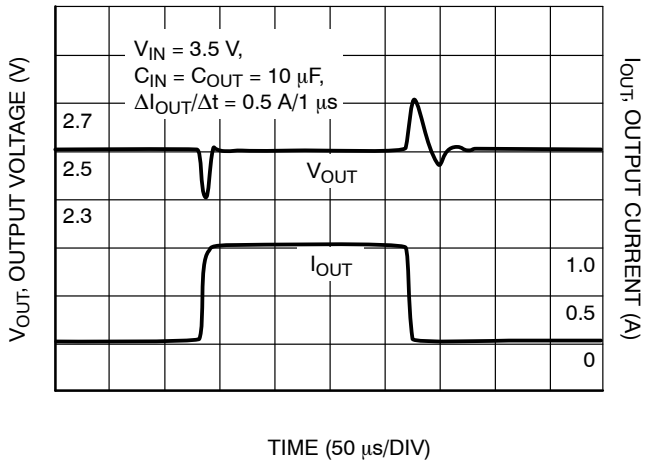

**Figure 23. Load Transient**  
( $V_{out} = 2.5\text{ V}$ )

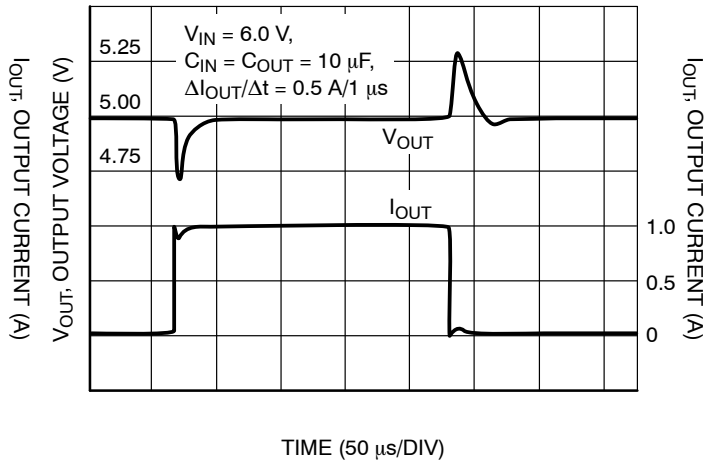

**Figure 24. Load Transient**  
( $V_{out} = 5.0\text{ V}$ )

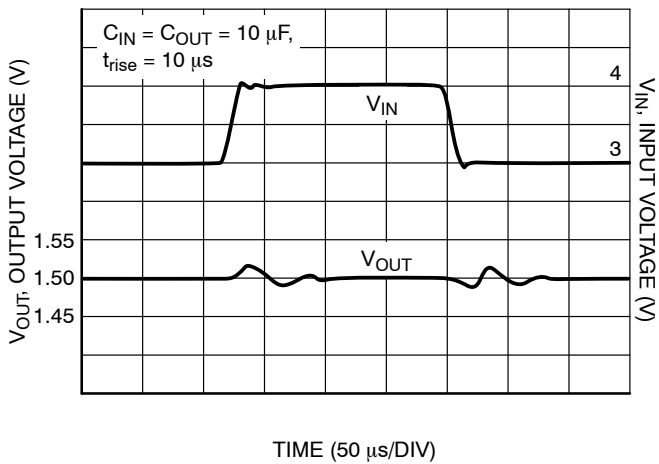

**Figure 25. Line Transient**  
( $V_{out} = 1.5\text{ V}$ )

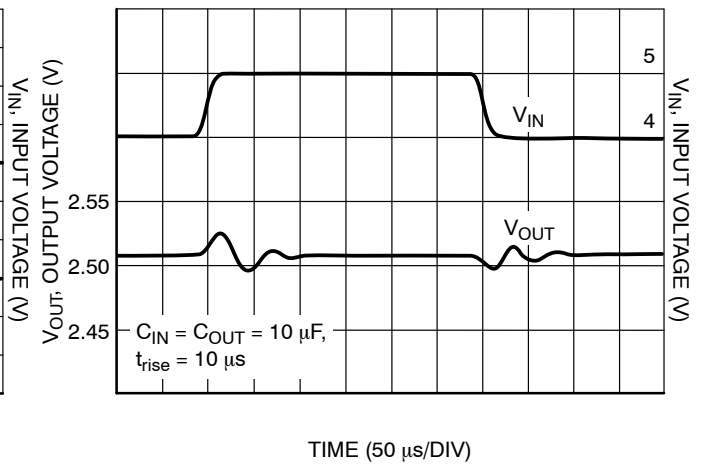

**Figure 26. Line Transient**  
( $V_{out} = 2.5\text{ V}$ )

# NCP690, NCP691, NCP692

## TYPICAL CHARACTERISTICS

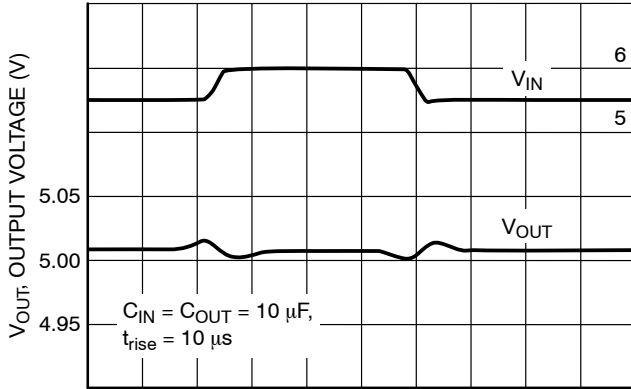

**Figure 27. Line Transient**  
( $V_{out} = 5.0 V$ )

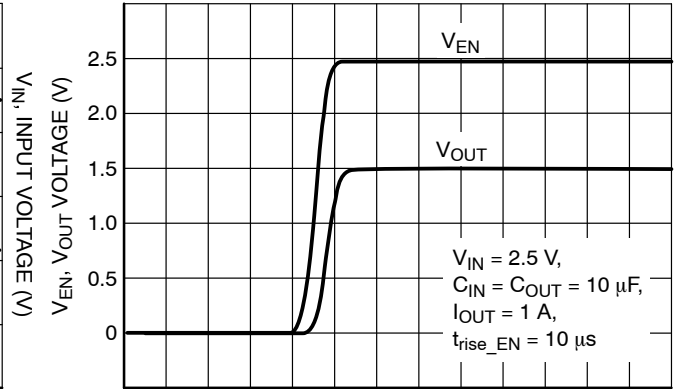

**Figure 28. Start-Up Transient**  
( $V_{out} = 1.5 V$ )

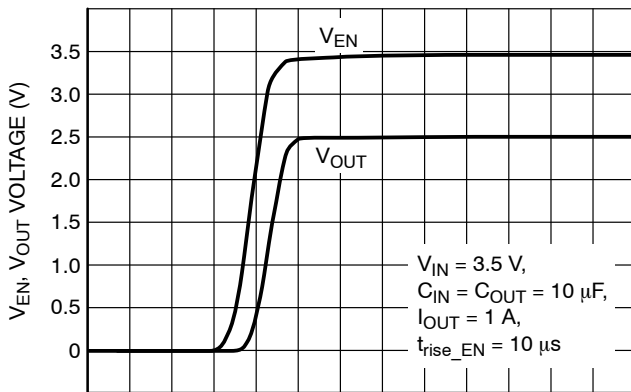

**Figure 29. Start-Up Transient**  
( $V_{out} = 2.5 V$ )

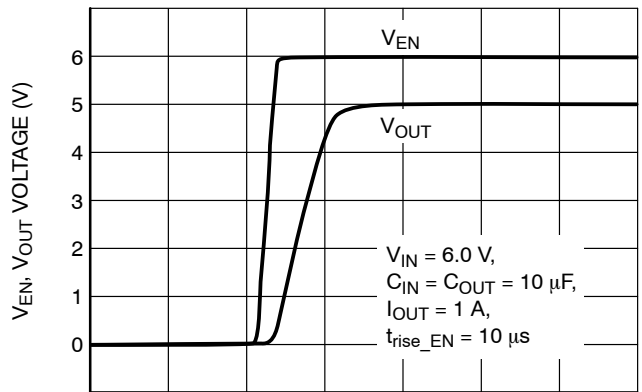

**Figure 30. Start-Up Transient**  
( $V_{out} = 5.0 V$ )

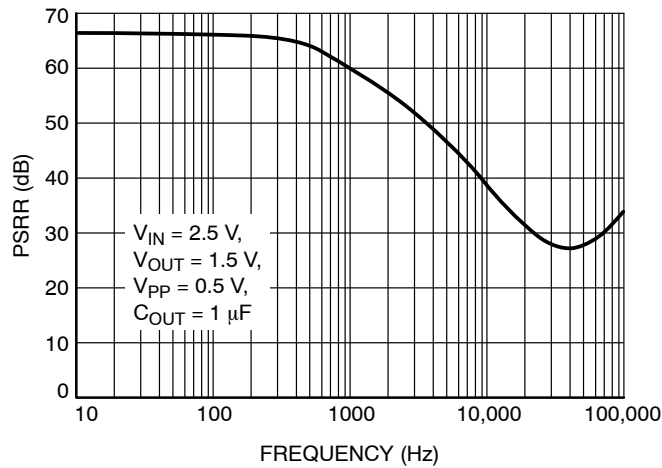

**Figure 31. PSRR vs. Frequency**  
( $V_{out} = 1.5 V$ )

## DEFINITIONS

**Load Regulation**

The change in output voltage for a change in output load current at a constant temperature.

**Dropout Voltage**

The input/output differential at which the regulator output no longer maintains regulation against further reductions in input voltage. Measured, when the output drops 100 mV below its nominal value. The junction temperature, load current, and minimum input supply requirements affect the dropout level.

**Output Noise Voltage**

This is the integrated value of the output noise over a specified frequency range. Input voltage and output load current are kept constant during the measurement. Results are expressed in  $\mu\text{V}_{\text{rms}}$  or  $\text{nV}/\sqrt{\text{Hz}}$ .

**Ground Current**

Ground Current is the current that flows through the ground pin when the regulator operates without a load on its output ( $I_{\text{GND}}$ ). This consists of internal IC operation, bias, etc. It is actually the difference between the input current (measured through the LDO input pin) and the output load current. If the regulator has an input pin that reduces its internal bias and shuts off the output (enable/disable function), this term is called the disable current ( $I_{\text{DIS}}$ ).

**Line Regulation**

The change in output voltage for a change in input voltage. The measurement is made under conditions of low dissipation or by using pulse techniques such that the average junction temperature is not significantly affected.

**Line Transient Response**

Typical output voltage overshoot and undershoot response when the input voltage is excited with a given slope.

**Load Transient Response**

Typical output voltage overshoot and undershoot response when the output current is excited with a given slope between no-load and full-load conditions.

**Thermal Protection**

Internal thermal shutdown circuitry is provided to protect the integrated circuit in the event that the maximum junction temperature is exceeded. When activated at typically  $175^{\circ}\text{C}$ , the regulator turns off. This feature is provided to prevent failures from accidental overheating.

**Maximum Package Power Dissipation**

The power dissipation level at which the junction temperature reaches its maximum operating value.

## APPLICATIONS INFORMATION

The NCP690 regulator is self-protected with internal thermal shutdown and internal current limit. Typical application circuit is shown in Figure 1.

**Input Decoupling ( $C_{\text{IN}}$ )**

A ceramic 10  $\mu\text{F}$  capacitor is recommended and should be connected close to the NCP690 package. Higher capacitance and lower ESR will improve the overall line transient response.

**Output Decoupling ( $C_{\text{OUT}}$ )**

The NCP690 does not require a minimum Equivalent Series Resistance (ESR) for the output capacitor. The minimum output decoupling capacitor required for stability is 1  $\mu\text{F}$ . In order to improve the load transient response and start up performance 10  $\mu\text{F}$  capacitor is recommended. The regulator is stable with ceramic chip as well as tantalum capacitors. Larger values improve noise rejection and load transient response.

**No-Load Regulation Considerations**

The required minimum 100  $\mu\text{A}$  load current is assured by the internal resistor divider network.

The NCP690 contain an overshoot clamp circuit to improve transient response during a load current step release. When output voltage exceeds the nominal by

approximately 20 mV, this circuit becomes active and clamps the output from further voltage increase. Tying the ENABLE pin to VIN will ensure that the part is active whenever the supply voltage is present,

**Noise Decoupling**

The NCP690 is a low noise regulator and needs no external noise reduction capacitor. Unlike other low noise regulators which require an external capacitor and have slow startup times, the NCP690 operates without a noise reduction capacitor, has a typical 50  $\mu\text{s}$  turn-on time and achieves a 50  $\mu\text{V}_{\text{rms}}$  overall noise level between 10 Hz and 100 kHz.

**Enable Operation**

The enable pin will turn the regulator on or off. The threshold limits are covered in the electrical characteristics table in this data sheet. The turn-on/turn-off transient voltage being supplied to the enable pin should exceed a slew rate of 10  $\text{mV}/\mu\text{s}$  to ensure correct operation. If the enable function is not to be used then the pin should be connected to VIN.

**Adjustable Operation**

The output voltage can be adjusted from 1 to 4 times the typical 1.250 V regulation voltage by the use of resistor

## NCP690, NCP691, NCP692

divider network as shown on Figure 4. The output voltage and resistors should be chosen using Equations 1 and 2.

$$V_{OUT} = 1.250 \left( 1 + \frac{R_1}{R_2} \right) + (I_{ADJ} \cdot R_1) \quad (\text{eq. 1})$$

$$R_2 \cong R_1 \frac{1}{\frac{V_{OUT}}{1.25} - 1} \quad (\text{eq. 2})$$

Input bias current  $I_{ADJ}$  is typically less than 210 nA. Choose  $R_1$  arbitrarily to minimize errors due to the bias current and to minimize noise contribution to the output voltage. Use Equation 2 to find the required value for  $R_2$ . If an output voltage of 1.25 V is desired, the adjustable pin should be connected directly to the output pin.

### Thermal Characteristics

As power dissipated in the NCP690 increases, it might become necessary to provide some thermal relief. The maximum power dissipation supported by the device is dependent upon board design and layout. Mounting pad configuration on the PCB, the board material, and the ambient temperature affect the rate of junction temperature rise for the part. When the NCP690 has good thermal conductivity through the PCB, the junction temperature will be relatively low with high power applications. The maximum dissipation the NCP690 can handle is given by:

$$P_{D(MAX)} = \frac{[T_{J(MAX)} - T_A]}{R_{\theta JA}} \quad (\text{eq. 3})$$

Since  $T_J$  is not recommended to exceed 125°C ( $T_{J(MAX)}$ ), then the NCP690 can dissipate up to 1 W when the ambient temperature ( $T_A$ ) is 25°C.

The power dissipated by the NCP690 can be calculated from the following equations:

$$P_D \approx V_{IN}(I_{GND} @ I_{OUT}) + I_{OUT}(V_{IN} - V_{OUT}) \quad (\text{eq. 4})$$

or

$$V_{IN(MAX)} \approx \frac{P_{D(MAX)} + (V_{OUT} \times I_{OUT})}{I_{OUT} + I_{GND}} \quad (\text{eq. 5})$$

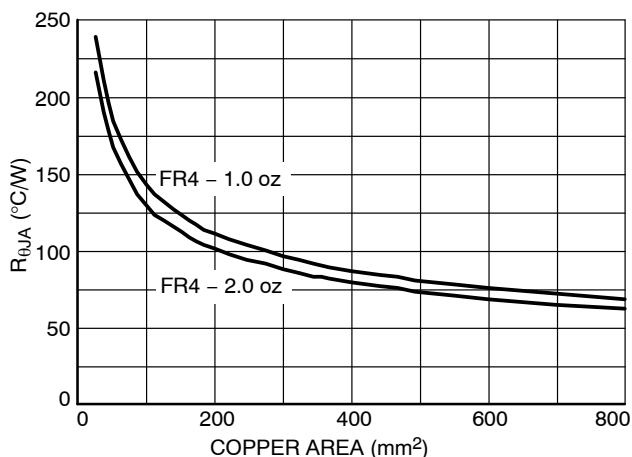

Figure 32. Thermal Resistance vs. Copper Area

### Hints

$V_{IN}$  and GND printed circuit board traces should be as wide as possible. When the impedance of these traces is high, there is a chance to pick up noise or cause the regulator to malfunction. Place external components, especially the output capacitor, as close as possible to the NCP690, and make traces as short as possible.

## NCP690, NCP691, NCP692

### DEVICE ORDERING INFORMATION

Device	Nominal Output Voltage	Marking	Package	Shipping <sup>†</sup>
NCP690MN15T2G	1.5 V	69015	DFN6 (Pb-Free)	3000 / Tape & Reel
NCP690MN18T2G	1.8 V	69018	DFN6 (Pb-Free)	3000 / Tape & Reel
NCP690MN25T2G	2.5 V	69025	DFN6 (Pb-Free)	3000 / Tape & Reel
NCP690MN33T2G	3.3 V	69033	DFN6 (Pb-Free)	3000 / Tape & Reel
NCP690MN50T2G	5.0 V	69050	DFN6 (Pb-Free)	3000 / Tape & Reel
NCP690MNADJT2G	ADJ	690AD	DFN6 (Pb-Free)	3000 / Tape & Reel
NCP691MN15T2G	1.5 V	69115	DFN6 (Pb-Free)	3000 / Tape & Reel
NCP691MN18T2G	1.8 V	69118	DFN6 (Pb-Free)	3000 / Tape & Reel
NCP691MN25T2G	2.5 V	69125	DFN6 (Pb-Free)	3000 / Tape & Reel
NCP691MN33T2G	3.3 V	69133	DFN6 (Pb-Free)	3000 / Tape & Reel
NCP691MN50T2G	5.0 V	69150	DFN6 (Pb-Free)	3000 / Tape & Reel
NCP691MNADJT2G	ADJ	691AD	DFN6 (Pb-Free)	3000 / Tape & Reel
NCP692MN15T2G	1.5 V	69215	DFN6 (Pb-Free)	3000 / Tape & Reel
NCP692MN18T2G	1.8 V	69218	DFN6 (Pb-Free)	3000 / Tape & Reel
NCP692MN25T2G	2.5 V	69225	DFN6 (Pb-Free)	3000 / Tape & Reel
NCP692MN33T2G	3.3 V	69233	DFN6 (Pb-Free)	3000 / Tape & Reel
NCP692MN50T2G	5.0 V	69250	DFN6 (Pb-Free)	3000 / Tape & Reel
NCP692MNADJT2G	ADJ	692AD	DFN6 (Pb-Free)	3000 / Tape & Reel

<sup>†</sup>For information on tape and reel specifications, including part orientation and tape sizes, please refer to our Tape and Reel Packaging Specifications Brochure, BRD8011/D.

# NCP690, NCP691, NCP692

## PACKAGE DIMENSIONS

DFN6 3\*3 MM, 0.95 PITCH  
CASE 506AH-01  
ISSUE O

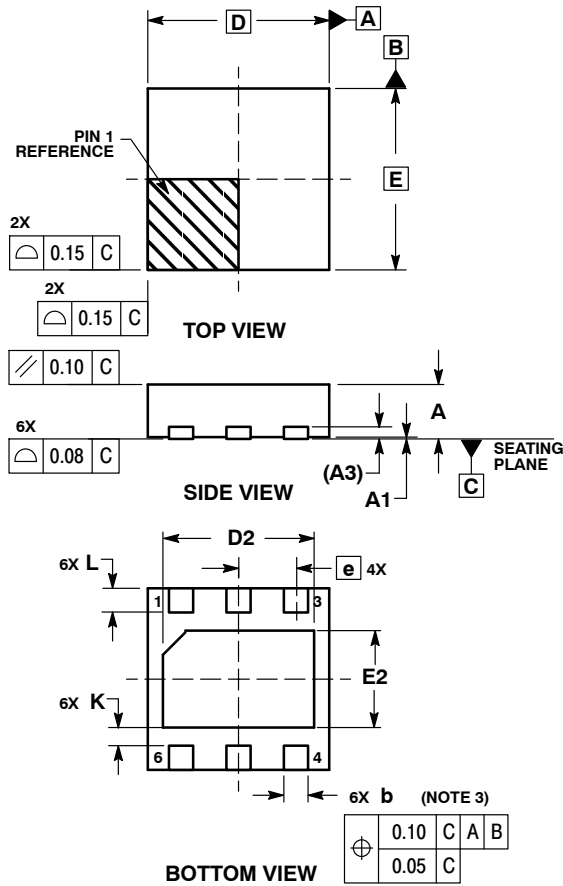

**NOTES:**

1. DIMENSIONS AND TOLERANCING PER ASME Y14.5M, 1994.
2. CONTROLLING DIMENSION: MILLIMETERS.
3. DIMENSION b APPLIES TO PLATED TERMINAL AND IS MEASURED BETWEEN 0.25 AND 0.30 MM FROM TERMINAL.
4. COPLANARITY APPLIES TO THE EXPOSED PAD AS WELL AS THE TERMINALS.

MILLIMETERS			
DIM	MIN	NOM	MAX
A	0.80	0.90	1.00
A1	0.00	0.03	0.05
A3	0.20 REF		
b	0.35	0.40	0.45
D	3.00 BSC		
D2	2.40	2.50	2.60
E	3.00 BSC		
E2	1.50	1.60	1.70
e	0.95 BSC		
K	0.21	---	---
L	0.30	0.40	0.50

### SOLDERING FOOTPRINT\*

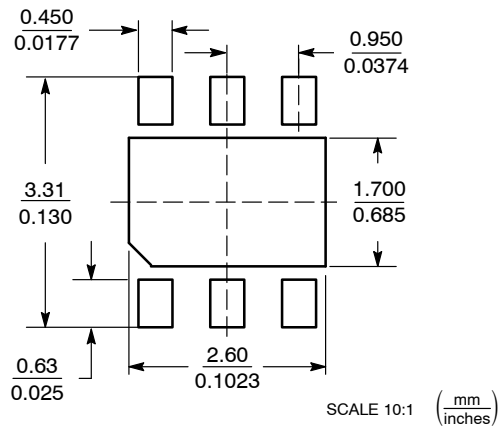

\*For additional information on our Pb-Free strategy and soldering details, please download the ON Semiconductor Soldering and Mounting Techniques Reference Manual, SOLDERRM/D.

ON Semiconductor and are registered trademarks of Semiconductor Components Industries, LLC (SCILLC). SCILLC owns the rights to a number of patents, trademarks, copyrights, trade secrets, and other intellectual property. A listing of SCILLC's product/patent coverage may be accessed at [www.onsemi.com/site/pdf/Patent-Marking.pdf](http://www.onsemi.com/site/pdf/Patent-Marking.pdf). SCILLC reserves the right to make changes without further notice to any products herein. SCILLC makes no warranty, representation or guarantee regarding the suitability of its products for any particular purpose, nor does SCILLC assume any liability arising out of the application or use of any product or circuit, and specifically disclaims any and all liability, including without limitation special, consequential or incidental damages. "Typical" parameters which may be provided in SCILLC data sheets and/or specifications can and do vary in different applications and actual performance may vary over time. All operating parameters, including "Typicals" must be validated for each customer application by customer's technical experts. SCILLC does not convey any license under its patent rights nor the rights of others. SCILLC products are not designed, intended, or authorized for use as components in systems intended for surgical implant into the body, or other applications intended to support or sustain life, or for any other application in which the failure of the SCILLC product could create a situation where personal injury or death may occur. Should Buyer purchase or use SCILLC products for any such unintended or unauthorized application, Buyer shall indemnify and hold SCILLC and its officers, employees, subsidiaries, affiliates, and distributors harmless against all claims, costs, damages, and expenses, and reasonable attorney fees arising out of, directly or indirectly, any claim of personal injury or death associated with such unintended or unauthorized use, even if such claim alleges that SCILLC was negligent regarding the design or manufacture of the part. SCILLC is an Equal Opportunity/Affirmative Action Employer. This literature is subject to all applicable copyright laws and is not for resale in any manner.

### PUBLICATION ORDERING INFORMATION

**LITERATURE FULFILLMENT:**

Literature Distribution Center for ON Semiconductor  
P.O. Box 5163, Denver, Colorado 80217 USA  
Phone: 303-675-2175 or 800-344-3860 Toll Free USA/Canada  
Fax: 303-675-2176 or 800-344-3867 Toll Free USA/Canada  
Email: [orderlit@onsemi.com](mailto:orderlit@onsemi.com)

**N. American Technical Support:** 800-282-9855 Toll Free  
USA/Canada  
**Europe, Middle East and Africa Technical Support:**  
Phone: 421 33 790 2910  
**Japan Customer Focus Center**  
Phone: 81-3-5817-1050

**ON Semiconductor Website:** [www.onsemi.com](http://www.onsemi.com)  
**Order Literature:** <http://www.onsemi.com/orderlit>  
For additional information, please contact your local Sales Representative

## Данный компонент на территории Российской Федерации

### Вы можете приобрести в компании MosChip.

Для оперативного оформления запроса Вам необходимо перейти по данной ссылке:

<http://moschip.ru/get-element>

Вы можете разместить у нас заказ для любого Вашего проекта, будь то серийное производство или разработка единичного прибора.

В нашем ассортименте представлены ведущие мировые производители активных и пассивных электронных компонентов.

Нашей специализацией является поставка электронной компонентной базы двойного назначения, продукции таких производителей как XILINX, Intel (ex.ALTERA), Vicor, Microchip, Texas Instruments, Analog Devices, Mini-Circuits, Amphenol, Glenair.

Сотрудничество с глобальными дистрибьюторами электронных компонентов, предоставляет возможность заказывать и получать с международных складов практически любой перечень компонентов в оптимальные для Вас сроки.

На всех этапах разработки и производства наши партнеры могут получить квалифицированную поддержку опытных инженеров.

Система менеджмента качества компании отвечает требованиям в соответствии с ГОСТ Р ИСО 9001, ГОСТ РВ 0015-002 и ЭС РД 009

### Офис по работе с юридическими лицами:

105318, г.Москва, ул.Щербаковская д.3, офис 1107, 1118, ДЦ «Щербаковский»

Телефон: +7 495 668-12-70 (многоканальный)

Факс: +7 495 668-12-70 (доб.304)

E-mail: [info@moschip.ru](mailto:info@moschip.ru)

Skype отдела продаж:

moschip.ru

moschip.ru\_4

moschip.ru\_6

moschip.ru\_9