

HPUSB, USB, and HPPCI Emulators User's Guide

Revision 3.2, July 2012

Part Number
82-000760-01

Analog Devices, Inc.
One Technology Way
Norwood, Mass. 02062-9106



Copyright Information

© 2012 Analog Devices, Inc., ALL RIGHTS RESERVED. This document may not be reproduced in any form without prior, express written consent from Analog Devices, Inc.

Printed in the USA.

Disclaimer

Analog Devices, Inc. reserves the right to make changes to or to discontinue any product or service identified in this publication without notice.

Analog Devices assumes no liability for Analog Devices applications assistance, customer product design, customer software performance, or infringement of patents or services described herein. In addition, Analog Devices shall not be held liable for special, collateral, incidental or consequential damages in connection with or arising out of the furnishing, performance, or use of this product.

Analog Devices products are not intended for use in life-support applications, devices, or systems. Use of an Analog Devices product in such applications without the written consent of the appropriate Analog Devices officer is prohibited.

Users are restricted from copying, modifying, distributing, reverse engineering and reverse assembling or reverse compiling the Analog Devices emulator operational software (one copy may be made for back-up purposes only).

Trademark and Service Mark Notice

The Analog Devices logo, Blackfin, CrossCore, EngineerZone, EZ-Board, EZ-KIT Lite, SHARC, and VisualDSP++ are registered trademarks of Analog Devices, Inc.

All other brand and product names are trademarks or service marks of their respective owners.

Regulatory Compliance

The USB- and PCI-based emulators are designed to be used solely in a laboratory environment. The emulators are not intended for use as a consumer end product or as a portion of a consumer end product. The emulator board is an open system design which does not include a shielded enclosure and therefore may cause interference to other electrical devices in close proximity. This board should not be used in or near any medical equipment or RF devices.

The USB- and PCI-based emulators have been certified to comply with the essential requirements of the European EMC directive 2004/108/EC and therefore carries the “CE” mark.

The USB- and PCI-based emulators have been appended to Analog Devices, Inc. EMC Technical File (EMC TF) referenced **DSPTOOLS1**, issue 2, dated June 4, 2008 and were declared CE compliant by an appointed Notified Body (No.0673) as listed below.

Notified Body Statement of Compliance: Z600ANA1.015 and Z600ANA1.014 dated September 30, 2003.

Issued by: Technology International (Europe) Limited
56 Shrivenham Hundred Business Park
Shrivenham, Swindon, SN6 8TY, UK



The USB- and PCI-based emulators contain ESD (electrostatic discharge) sensitive devices. Electrostatic charges readily accumulate on the human body and equipment and can discharge without detection. Permanent damage may occur on devices subjected to high-energy discharges. Proper ESD precautions are recommended to avoid performance degradation or loss of functionality. Store unused emulators in the protective shipping package.



CONTENTS

PREFACE

Purpose of This Manual	ix
Intended Audience	ix
Manual Contents	ix
Technical Support	x
Product Information	xi
Analog Devices Web Site	xi
EngineerZone	xii
Notation Conventions	xii

GETTING STARTED

Contents of Emulator Package	1-2
PC Configuration	1-2
USB- and PCI-based Emulator Installation Tasks	1-3
Installing a USB-Based Emulator	1-3
Installing a PCI-Based Emulator	1-4
Verifying Driver Installation and Attaching to an Emulation Target	1-5
Applying Power to the Emulator	1-6
Configurator Software	1-7

Contents

JTAG Frequency Selection	1-8
HPPCI JTAG I/O Voltage Detection	1-11
HPUSB/USB Legacy Mode	1-11
HPPCI-ICE Legacy/Auto Detection Mode	1-12
Legacy Mode (Factory Default Setting)	1-13
Auto Detection Mode	1-14
Troubleshooting and Warranty	1-16

HARDWARE DESCRIPTION

LEDs	2-1
HPUSB-ICE/USB-ICE LEDs	2-1
HPPCI-ICE LEDs	2-2
Pod LEDs	2-2
Board LEDs	2-4
Custom Processor Boards	2-5
HPPCI-ICE	2-5

SUPPORT

Technical Support	3-1
Quality Assurance	3-2

REFERENCES

INDEX

PREFACE

Thank you for purchasing an Analog Devices USB- or PCI-based JTAG emulator. The USB-based emulator family consists of the High-Performance USB JTAG emulator and the USB JTAG emulator.

The USB-based emulators are used in conjunction with the CrossCore[®] Embedded Studio and VisualDSP++[®] development environments to create, test, and debug advanced processor application software on Analog Devices fixed- and floating-point JTAG-based processors. The PCI-based emulators are used in conjunction with VisualDSP++.

The HPUSB-ICE system provides state-of-the-art support for JTAG-compliant Analog Devices processors. Key features of the HPUSB-ICE include:

- Plug-n-Play, USB 2.0 compliant
- High-speed USB device
- Windows[®] 2000, Windows XP, Windows Vista, or Windows 7 operation
- Multiple processor I/O voltage support
 - 1.8V, 2.5V, and 3.3V compliance
 - 5V tolerant in all ranges
- Multiprocessor support
- JTAG clock operation up to 50 MHz

The HPPCI-ICE system provides state-of-the-art support for JTAG-compliant Analog Devices processors. Key features of the HPPCI-ICE include:

- Plug-n-Play, PCI 2.2 compliant
- Windows 2000, Windows XP, Windows Vista, or Windows 7 operation
- Multiple processor I/O voltage support:
 - 1.8V, 2.5V, and 3.3V compliance
 - 5V tolerant in all ranges
- Multiprocessor support
- JTAG clock operation up to 50 MHz



The JTAG clock frequency is dependent on the delay characteristics of the JTAG interface and processor on the target board.

The USB-ICE system provides state-of-the-art support for selected processors. Key features of the USB-ICE include:

- Plug-n-Play, USB 2.0 compliant
- High-speed USB device
- Windows 2000, Windows XP, Windows Vista, or Windows 7 operation
- Multiple processor I/O voltage support:
 - 1.8V, 2.5V, and 3.3V compliance
 - 5V tolerant in all ranges
- Multiprocessor support
- JTAG clock operation up to 50 MHz

Analog Devices carries a wide range of in-circuit emulation products. To learn more about Analog Devices emulators, go to:
http://www.analog.com/en/processors-dsp/software-and-reference-designs/content/tools_product_overview/fca.html.

Purpose of This Manual

The *HPUSB, USB, and HPPCI Emulators User's Guide* provides directions for installing the high-performance USB-ICE, USB ICE, and high-performance HPPCI-ICE hardware and software on your PC. The manual also describes how to configure and use the components of the USB- and PCI-based emulators.

Intended Audience

This manual is intended to help the customer understand the features and operation of the HPUSB-ICE, HPPCI-ICE, and USB-ICE so they start using CrossCore Embedded Studio or VisualDSP++.

Manual Contents

The manual consists of:

- Chapter 1, “[Getting Started](#)” on page 1-1
Provides software and hardware installation procedures, PC system requirements, and basic board information.
- Chapter 2, “[Hardware Description](#)” on page 2-1
Provides information on hardware aspects of the USB-based emulators.

Technical Support

- Chapter 3, “Support” on page 3-1
Provides technical support contact information.
- Chapter 4, “References” on page 4-1
Provides information about different resources available for developing an application based on an Analog Devices processor.

Technical Support

You can reach Analog Devices processors and DSP technical support in the following ways:

- Post your questions in the processors and DSP support community at EngineerZone[®]:
<http://ez.analog.com/community/dsp>
- Submit your questions to technical support directly at:
<http://www.analog.com/support>
- E-mail your questions about processors, DSPs, and tools development software from **CrossCore Embedded Studio** or **VisualDSP++[®]**:

Choose **Help > Email Support**. This creates an e-mail to processor.tools.support@analog.com and automatically attaches your **CrossCore Embedded Studio** or **VisualDSP++** version information and `license.dat` file.

- E-mail your questions about processors and processor applications to:
processor.support@analog.com or
processor.china@analog.com (Greater China support)
- In the **USA only**, call **1-800-ANALOGD** (1-800-262-5643)

- Contact your Analog Devices sales office or authorized distributor.
Locate one at:
www.analog.com/adi-sales
- Send questions by mail to:
Processors and DSP Technical Support
Analog Devices, Inc.
Three Technology Way
P.O. Box 9106
Norwood, MA 02062-9106
USA

Product Information

Product information can be obtained from the Analog Devices Web site and the CCES online help.

Analog Devices Web Site

The Analog Devices Web site, www.analog.com, provides information about a broad range of products—analogue integrated circuits, amplifiers, converters, and digital signal processors.

To access a complete technical library for each processor family, go to http://www.analog.com/processors/technical_library. The manuals selection opens a list of current manuals related to the product as well as a link to the previous revisions of the manuals. When locating your manual title, note a possible errata check mark next to the title that leads to the current correction report against the manual.

Also note, [myAnalog](#) is a free feature of the Analog Devices Web site that allows customization of a Web page to display only the latest information about products you are interested in. You can choose to receive weekly e-mail notifications containing updates to the Web pages that meet your

Notation Conventions

interests, including documentation errata against all manuals. [myAnalog](#) provides access to books, application notes, data sheets, code examples, and more.

Visit [myAnalog](#) to sign up. If you are a registered user, just log on. Your user name is your e-mail address.

EngineerZone



EngineerZone is a technical support forum from Analog Devices. It allows you direct access to ADI technical support engineers. You can search FAQs and technical information to get quick answers to your embedded processing and DSP design questions.

Use EngineerZone to connect with other DSP developers who face similar design challenges. You can also use this open forum to share knowledge and collaborate with the ADI support team and your peers. Visit <http://ez.analog.com> to sign up.

Notation Conventions

Text conventions used in this manual are identified and described as follows.

Example	Description
Close command (File menu)	Titles in in bold style reference sections indicate the location of an item within the CrossCore Embedded Studio's menu system (for example, the Close command appears on the File menu).
{this that}	Alternative required items in syntax descriptions appear within curly brackets and separated by vertical bars; read the example as <i>this</i> or <i>that</i> . One or the other is required.
[this that]	Optional items in syntax descriptions appear within brackets and separated by vertical bars; read the example as an optional <i>this</i> or <i>that</i> .

Example	Description
[this,...]	Optional item lists in syntax descriptions appear within brackets delimited by commas and terminated with an ellipsis; read the example as an optional comma-separated list of <i>this</i> .
.SECTION	Commands, directives, keywords, and feature names are in text with letter gothic font.
<i>filename</i>	Non-keyword placeholders appear in text with italic style format.
	<p>Note: For correct operation, ...</p> <p>A Note provides supplementary information on a related topic. In the online version of this book, the word Note appears instead of this symbol.</p>
	<p>Caution: Incorrect device operation may result if ...</p> <p>Caution: Device damage may result if ...</p> <p>A Caution identifies conditions or inappropriate usage of the product that could lead to undesirable results or product damage. In the online version of this book, the word Caution appears instead of this symbol.</p>
	<p>Warning: Injury to device users may result if ...</p> <p>A Warning identifies conditions or inappropriate usage of the product that could lead to conditions that are potentially hazardous for devices users. In the online version of this book, the word Warning appears instead of this symbol.</p>

Notation Conventions

1 GETTING STARTED

This chapter provides the information needed to begin using Analog Devices USB- and PCI-based emulators.

 Analog Devices emulators are not intended to be used in a production environment.

This chapter includes the following sections.

- [“Contents of Emulator Package” on page 1-2](#)
Provides a list of components shipped with USB- and PCI-based emulators.
- [“PC Configuration” on page 1-2](#)
Describes the minimal PC requirements.
- [“USB- and PCI-based Emulator Installation Tasks” on page 1-3](#)
Provides a step-by-step procedure for setting up the emulator hardware and software.
- [“Configurator Software” on page 1-7](#)
Describes the target configurator utility.
- [“JTAG Frequency Selection” on page 1-8](#)
Provides information on JTAG frequency limitations.

Contents of Emulator Package

- [“HPPCI JTAG I/O Voltage Detection” on page 1-11](#)
Describes the JTAG I/O voltage detection feature of HPPCI emulators.
- [“Troubleshooting and Warranty” on page 1-16](#)
Points to an Engineer-to-Engineer Note for troubleshooting advice and warranty information.

Contents of Emulator Package

Your USB-based emulator package contains the following items.

- HPUSB-ICE or USB-ICE assembly
- 5-volt power supply
- 3-meter USB type-A to mini-B cable

Your High-Performance PCI emulator package contains the following items.

- HPPCI-ICE or JTAG daughter card
- HPPCI-ICE pod assembly

PC Configuration

For correct operation of a USB- or PCI-based emulator, your PC must meet the minimum requirements.

PC Configuration	USB-Based Emulators	PCI-Based Emulators
Operating system	Windows 2000, Windows XP SP2, Windows Vista, or Windows 7	
Development software	CrossCore Embedded Studio (CCES) or VisualDSP++	VisualDSP++
I/O port	One available USB full- or high-speed port	One available PCI slot

USB- and PCI-based Emulator Installation Tasks

Perform the following tasks to install your USB- or PCI-based emulator safely. Follow the instructions in presented order to ensure correct operation of your software and hardware.

1. [Installing a USB-Based Emulator](#) or [Installing a PCI-Based Emulator](#)
2. [Verifying Driver Installation and Attaching to an Emulation Target](#)
3. [Applying Power to the Emulator](#)

Installing a USB-Based Emulator

1. Install CCES or VisualDSP++ on your computer. The installation includes a USB driver required for your USB-based emulator.

If CCES or VisualDSP++ is installed already, you do not need to install it again.

USB- and PCI-based Emulator Installation Tasks

Note: If you connect the emulator first (before installing CCES or VisualDSP++) to the PC, the Windows driver wizard will not find the drivers for the emulator.

2. Connect one side of the provided USB cable to the USB assembly of the emulator and the other side to an open USB port of your computer.

[Verifying Driver Installation and Attaching to an Emulation Target](#) is next.

Installing a PCI-Based Emulator



The driver must be installed before you start the HPPCI-ICE for the first time.

1. Install the HPPCI-ICE hardware. For instructions on installing a PCI card into your computer, consult documentation provided by the computer manufacturer.
2. Install VisualDSP++. VisualDSP++ includes the HPPCI driver needed for your PCI emulation hardware. Refer to the *VisualDSP++ Installation Quick Reference Card* for details.

[Verifying Driver Installation and Attaching to an Emulation Target](#) is next.

Verifying Driver Installation and Attaching to an Emulation Target

Before using your USB- or PCI-based emulator, verify that the driver software is installed properly.

1. Open the Windows **Device Manager** and verify that the HPUSB-ICE, HPPCI-ICE or USB-ICE appears under **ADI Development Tools** as shown in [Figure 1-1](#).

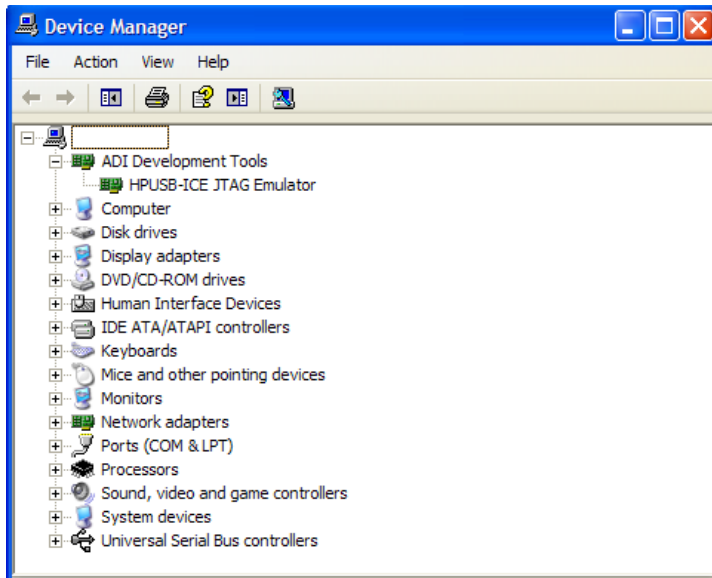



Figure 1-1. Verifying Driver Installation

2. Connect the 14-pin header side of the pod cable to the target board via the debug interface. The 14-pin connector is keyed at pin 3 on the pod cable to ensure that the cable sits correctly on the 14-pin target emulation header. The target board should also have pin 3 keyed.

USB- and PCI-based Emulator Installation Tasks

-  Do not connect or disconnect a USB emulator JTAG header, whether powered up or not, to/from a powered target.

[Applying Power to the Emulator](#) is next.

Applying Power to the Emulator

The final step is to power up the emulator.

The following procedures apply to HP-USB and USB emulators only.

Powering up a USB-based emulator:

1. Apply power to target board.
2. Apply power to the emulator
3. If the emulator is not connected to the PC, connect the devices with the USB cable as described in [Verifying Driver Installation and Attaching to an Emulation Target](#).
4. Invoke CrossCore Embedded Studio or VisualDSP++.

Powering down a USB-based emulator:

1. Shut down (exit) CrossCore Embedded Studio or VisualDSP++.
 2. Disconnect the USB cable from the emulator and PC.
 3. Power down the emulator.
 4. Power down the target board.
-  If the emulator has an “Enable/Power” LED, the power LED lights green when power is applied. The power LED lights amber when connected to a session or when the ICE Test utility is used. If the emulator has an “Enable” LED only, the LED lights amber

when connected to a session or when the ICE Test utility is used.

At all other times, the LED should be off.

For custom processor boards still in design, refer to the Engineer-to-Engineer Note, *Analog Devices JTAG Emulation Technical Reference (EE-68)*, available from the Analog Devices Web site. This document is a technical reference for implementing the JTAG interface on your target.

Now the emulator hardware is ready to be used in conjunction with CCES or VisualDSP++ to debug a processor target system. See [“Configurator Software”](#).

Configurator Software

CrossCore Embedded Studio and VisualDSP++ development software require a description of your *platform* (JTAG chain). The platform definition is necessary for the software to communicate with the hardware through the emulator.

The VisualDSP++ and CCES include the target configurator utility to configure and test your emulator hardware. The target configurator provides emulator detection, JTAG I/O voltage selection, and JTAG frequency selection. Use the ICE Test (part of the target configurator) to test the target. If any errors are encountered, the errors are reported immediately and the test ends. Each error message recommends a solution to the problem.

Refer to the online help for information about “target configurator”, “JTAG frequency”, and “ICE test”.

JTAG Frequency Selection

USB-ICE emulators, high-performance PCI-ICE, and high-performance USB-ICE emulators support a JTAG clock operation up to 50 MHz.

 Not all frequencies listed above are supported for all processor families. The displayed frequencies depend upon the processor family.

There is a relationship between the JTAG frequency and core clock frequency of the processor. Typically, the core clock runs at a frequency that is more than 2x the JTAG clock's frequency. On newer Analog Devices processors, the core clock is a variable that sometimes is set by switches or software.

 If the core/JTAG clock relation is not followed, scan failures can prevent the emulator from connecting to the processor.

Use the **JTAG Frequency Selection** dialog box to test and change the rate at which the JTAG Test Clock signal (TCK) runs. To access the dialog box:

- CrossCore Embedded Studio users choose **Target > Settings > JTAG Frequency Selection** after launching a debug configuration.
- VisualDSP++ users choose **Settings > JTAG Frequency Selection** after creating a debug session.

Figure 1-2 and Figure 1-3 show the JTAG Frequency Selection dialog box.

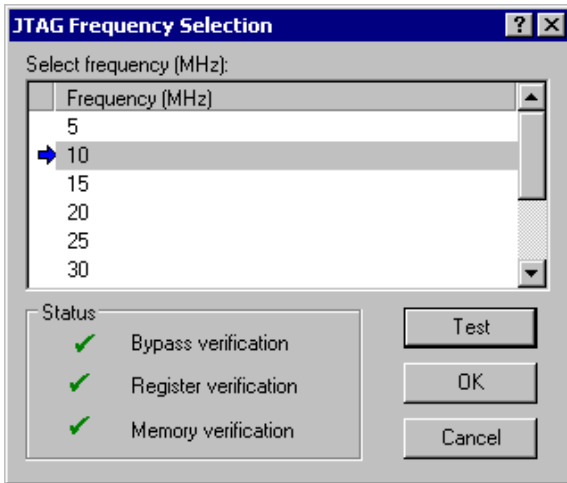

Figure 1-2. HPUSB-ICE JTAG Frequency Selection Dialog Box

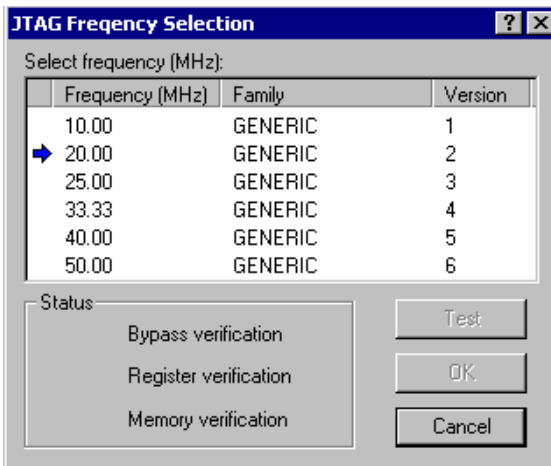

Figure 1-3. HPPCI-ICE JTAG Frequency Selection Dialog Box

JTAG Frequency Selection

The tests listed in the **Status** box are run when you click **Test** in the **JTAG Frequency Selection** dialog box. The blue arrow points to the current frequency. The arrow does not change after you run the tests because **Cancel** goes back to using the frequency pointed to by the blue arrow. To use a different frequency, select the appropriate frequency from the list and click **Test**. Click **OK** to use the frequency that is highlighted and tested already.

Table 1-1 describes the **JTAG Frequency Selection** dialog box.

Table 1-1. JTAG Frequency Selection Dialog Box

Item	Description
Select frequency (MHz)	Selects the frequency to run TCK.
Status	Updates status of the tests indicated within the test group. The test status indicator can show a “running” icon, “not running” icon, “pass” icon, or “fail” icon, depending on the test status.
Test	Tests the selected frequency by running the tests in the Status group. NOTE: If tests fail, you may have to shut down the IDE and restart your session.
OK	Saves the selected frequency. This should only be highlighted if all the tests have passed.
Cancel	Continues using the frequency pointed to by the blue arrow.



If you encounter a problem launching the CCES or VisualDSP++ at a certain frequency, delete your debug configuration/session and create a new debug configuration/session. This sets TCK back to the default value.

HPPCI JTAG I/O Voltage Detection

The mode of operation supported by the PCI emulator is dependent on the connection method used for the 14-pin JTAG header on your target. [Table 1-2](#) shows how the target JTAG header connects for legacy and auto detection modes.

Table 1-2. HPPCI JTAG Legacy and Auto Detection Modes

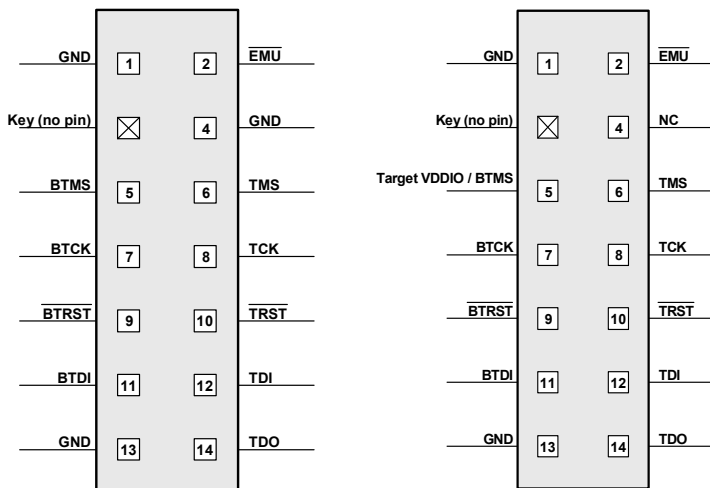

HPPCI JTAG I/O -- Legacy Pinout HPPCI JTAG I/O -- Auto Detection Pinout

HPUSB/USB Legacy Mode

Legacy mode is used for older targets that do not provide a target VDDIO input for automatic voltage detection by the emulator. In this mode, the voltage at which the JTAG signals run is set manually through the Configurator utility. The configurator utility provides a voltage selection setting when configuring the target.



HPUSB-ICE and USB-ICE emulators do not support auto voltage detection mode.

HPPCI-ICE Legacy/Auto Detection Mode

The factory default for the pod shown in [Figure 1-4](#) is legacy mode. For more information about available modes, refer to [“Auto Detection Mode” on page 1-14](#).

In order to modify the factory default setting, remove the four screws on the bottom of the plastic enclosure. When opening the case, first remove the top of the enclosure with the top facing up. This must be done to ensure that the four light pipes used for the LEDs are not damaged. The default pod setting is shown in [Figure 1-5](#). To determine whether the default setting of your HPPCI-ICE needs to be modified, refer to [“Legacy Mode \(Factory Default Setting\)”](#).

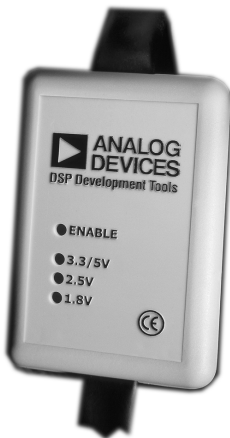

Figure 1-4. HPPCI-ICE Pod

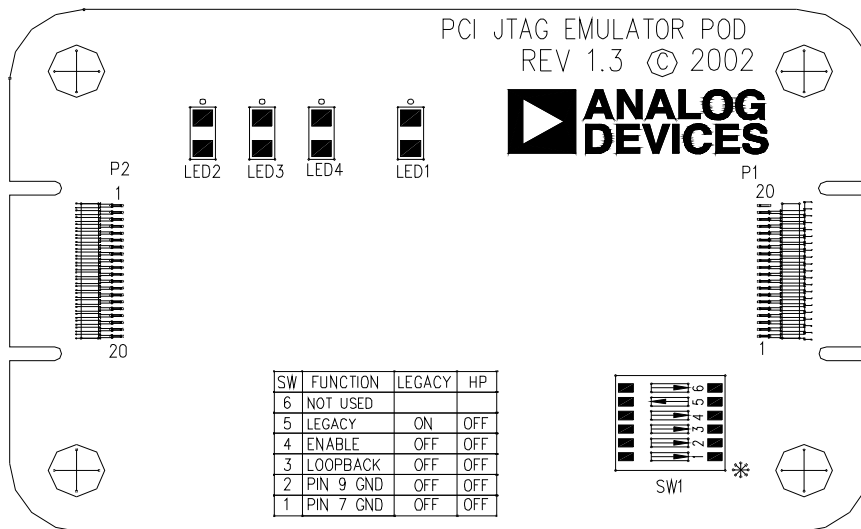

Figure 1-5. Default Switch Setting for HPPCI-ICE Pod

Legacy Mode (Factory Default Setting)

Legacy mode is used for older targets that do not support voltages less than 3.3V and do not provide an IOVDD input for automatic voltage detection by the pod. Consequently, the emulator in legacy mode is used for all previously designed 3.3V and 5V target boards. The HPPCI-ICE is 3.3V compliant and 5.0V tolerant in this mode and accepts both 3.3V and 5.0V signals but only drives 3.3V CMOS level signals. In legacy mode, the LED labeled 3.3/5V is lit.

The emulator is set to Legacy mode before leaving the factory. The switch must be set in the manner shown in [Figure 1-6](#) to verify that the emulator is in legacy mode, or to change the emulator to legacy mode.

HPPCI JTAG I/O Voltage Detection

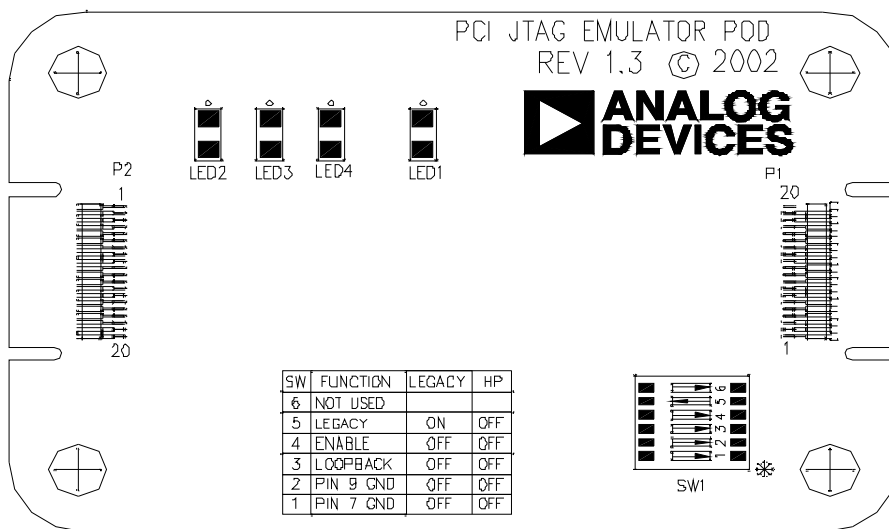

Figure 1-6. Legacy Switch Setting for HPPCI-ICE Pod

Auto Detection Mode

Auto detection mode is recommended for all newly designed target boards. This mode supports 1.8V, 2.5V, 3.3V, and 5V target boards. PCI-based emulators are 1.8V, 2.5V, and 3.3V-compliant in auto detection mode. This means that the emulator can accept 1.8V, 2.5V, and 3.3V signals and can also drive the respective 1.8V, 2.5V, and 3.3V CMOS level signals. The emulator is also 5V tolerant. Consequently, the emulator accepts 5V signals and drives 3.3V signals to the target.

In auto detection mode, the emulator samples the target VDDIO signal (pin 5 on the JTAG header) and drives the JTAG signals from the emulator at the sampled voltage. The respective 1.8V, 2.5V, or 3.3V/5V LED also lights up to indicate the voltage at which the JTAG signals are driven.

The emulator is set to legacy mode before leaving the factory. The switch must be set in the manner shown in [Figure 1-7](#) to verify that the emulator

is in auto detection mode, or to change the emulator to auto detection mode.

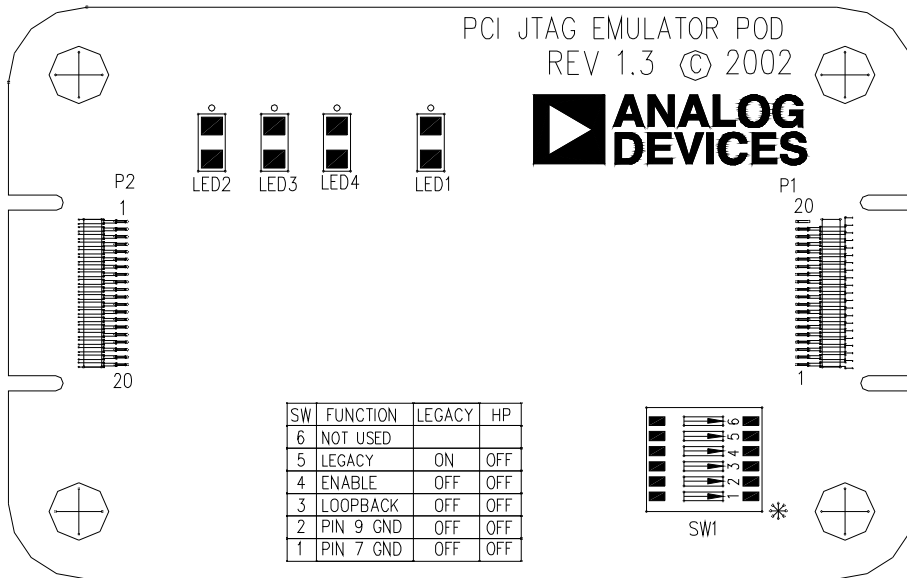

Figure 1-7. Auto Detection Switch Setting for HPPCI-ICE Pod

Troubleshooting and Warranty

To provide comprehensive troubleshooting advice and warranty information for all emulator and EZ-KIT Lite products, Analog Devices maintains an Engineer-to-Engineer Note. *Emulator and EZ-KIT Lite Evaluation System Troubleshooting Guide (EE-175)* is available online at: <http://www.analog.com>.

This EE-Note can be used to resolve most installation, connection, and software issues affecting the use of Analog Devices in-circuit emulators (ICEs) and EZ-KIT Lite evaluation systems, avoiding the need to return the suspected faulty emulator or EZ-KIT Lite board. Please carry out all troubleshooting steps outlined in this document before contacting Analog Devices Processor Tools Support.

Also included in the EE-Note, complete warranty and return material authorization (RMA) information for emulators and EZ-KIT Lite products. In general, emulators less than one year old are within warranty, and repairs within that period are free of charge, but there are some limitations to this warranty coverage. For details, see the note.

2 HARDWARE DESCRIPTION

This chapter describes the hardware design of the USB- and PCI-based emulators.

LEDs

This section describes the following LEDs:

- “HPUSB-ICE/USB-ICE LEDs”
- “HPPCI-ICE LEDs” on page 2-2
- “Pod LEDs” on page 2-2
- “Board LEDs” on page 2-4

HPUSB-ICE/USB-ICE LEDs

Four LEDs are located on the enclosure:

- 1.8V LED – Signifies that the ICE drives all signals at 1.8V compliant levels.
- 2.5V LED – Signifies that the ICE drives all signals at 2.5V compliant levels.

LEDs

- 3.3/5V LED – Signifies that the ICE drives all signals at 3.3V compliant levels.
- ENABLE – This LED is amber when the debugger is enabled. This means that the emulator is driving the JTAG signals, and the connector must not remove or plug onto a target when the light is amber. When the LED is green, the JTAG signals are not being driven, and it is safe to connect to a target. The green LED indicates that the board is powered up but not in emulation mode.

HPPCI-ICE LEDs

Four LEDs are located on the pod enclosure (Figure 2-1), and five LEDs are located on the daughter board (Figure 2-2).

Pod LEDs

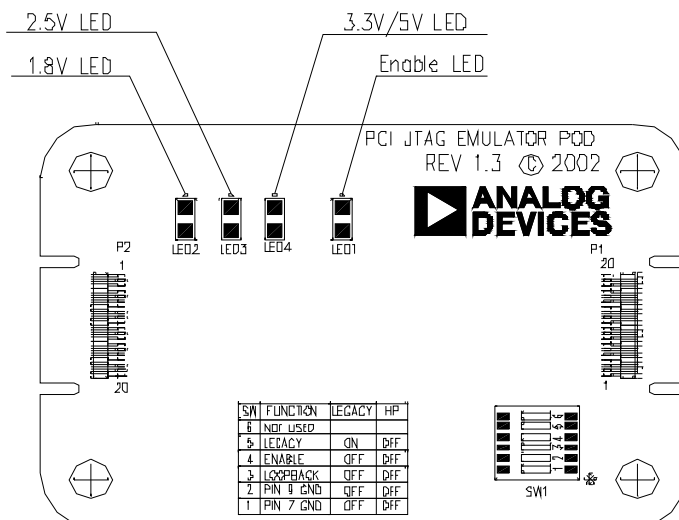

Figure 2-1. Pod LEDs

- 1.8V LED – In auto detection mode, this LED signifies that a target VDDIO of 1.8V has been detected on the JTAG header (pin 5) on the processor target board, and the HPPCI-ICE drives all signals at 1.8V compliant levels.
- 2.5V LED – In auto detection mode, this LED signifies that a target VDDIO of 2.5V has been detected on the JTAG header (pin 5) on the processor target board, and the HPPCI-ICE drives all signals at 2.5V compliant levels.
- 3.3/5V LED – In auto detection mode, this LED signifies that a target VDDIO of 3.3V or 5V has been detected on the JTAG header (pin 5) on the processor target board, and the HPPCI-ICE drives all signals at 3.3V compliant levels. In legacy mode, this LED is powered automatically, and pin 5 of the JTAG header on the target board is not used to detect the target VDDIO voltage.
- ENABLE – This LED is turned on when a CrossCore Embedded Studio (CCES) or VisualDSP++ debug session is running. This LED shuts off every time the session is closed. When this LED is off, it signifies all outputs of the pod logic connected to the target have been three-stated. Three-stating the outputs of the pod when the IDE is inactive prevents the target processor from entering an unknown state during the target power up sequencing.

Board LEDs

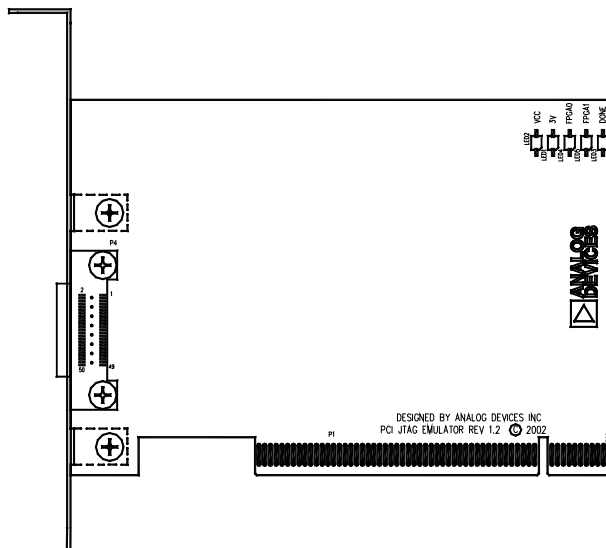

Figure 2-2. Board LEDs

- VCC – This LED signifies that the board is receiving 5V power. If this LED is not active, the HPPCI-ICE does not function properly.
- 3V – This LED signifies that the board is receiving 3.3V power. If this LED is not active, the HPPCI-ICE does not function properly.
- FPGA[1:0] – These two LEDs are used for factory purposes only.
- DONE – This LED is activated when a a CrossCore Embedded Studio or VisualDSP++ debug session is started. The LED should remain active even after the respective session has been terminated. The LED shuts off and re-activates at the beginning of every new session.

Custom Processor Boards

When designing a custom processor board using Analog Devices processors and DSPs, special care must be taken to ensure that the JTAG interface is designed and laid out correctly. If the board is not designed correctly, communication via the JTAG port may not work. Another side effect may be that the interface works, but you are not able to run at the highest possible JTAG clock frequency. The JTAG clock frequency is dependant on the particular Analog Devices processor, as well as the delay characteristics of the custom processor board.

To ensure that the custom board's JTAG interface is designed and laid out correctly, refer to Engineer-to-Engineer Note, *Analog Devices JTAG Emulation Technical Reference (EE-68)*, available from the Analog Devices Web site. This document is a technical reference for implementing the JTAG interface on your target.

HPPCI-ICE

The HPPCI-ICE consists of a daughter board and a pod cable. The system is compliant with revision 2.2 of the PCI specification and plugs into 5V-only motherboards. It uses only the 5 volts from the PC's PCI slot. The pod cable consists of a small PCB that has a multi-conductor cable soldered at each end. The multi-conductor cable is constructed with individual coaxial cables that are encapsulated by shield ground. The PCB in the pod is fully enclosed in a copper-sprayed plastic enclosure. The multi-conductor cables and copper spray reduce system noise and electromagnetic interference.

HPPCI-ICE

The mechanical dimensions of the daughter board, pod cable assembly, and pod enclosure are shown in [Figure 2-3](#), [Figure 2-4](#), and [Figure 2-5](#), respectively. Unless specified, all dimensions are in inches.

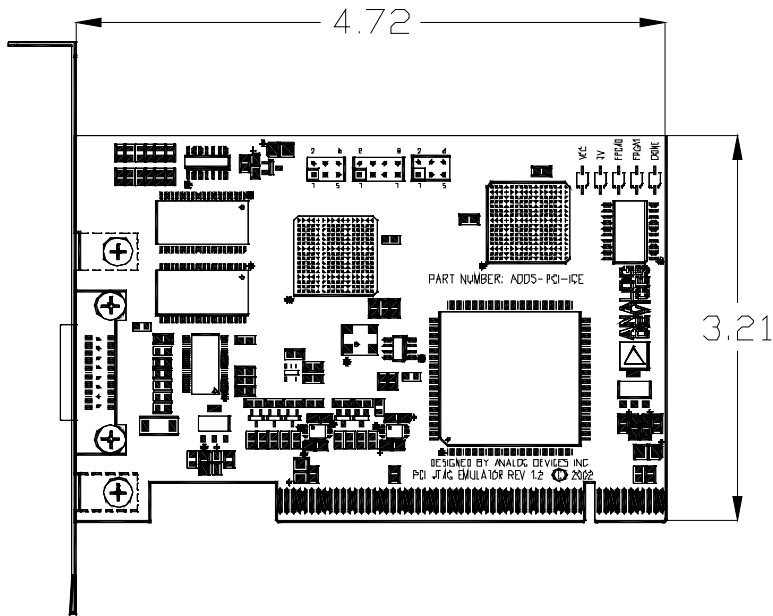

Figure 2-3. Daughter Board Dimensions (in inches)

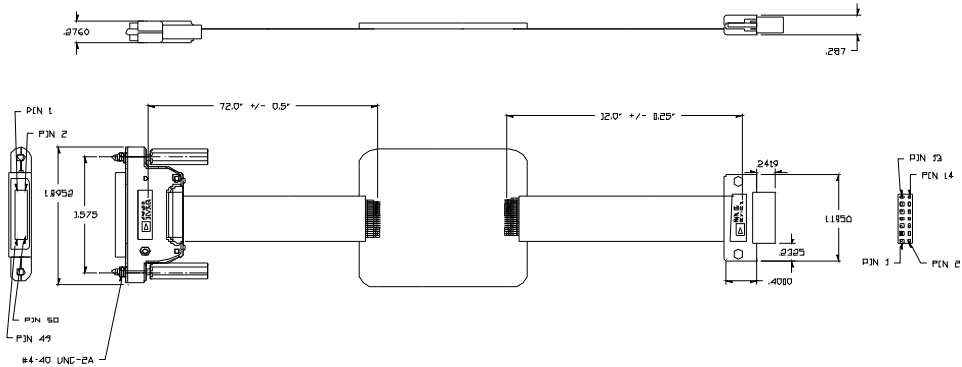

Figure 2-4. Pod Cable Dimensions (in inches)

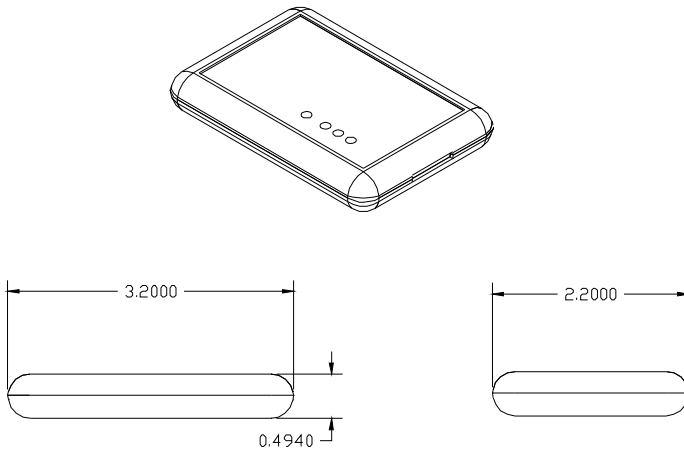

Figure 2-5. Pod Box Dimensions (in inches)

3 SUPPORT

Analog Devices provides free technical support.

Technical Support

For technical support, visit the Analog Devices Worldwide Technical Support page at:

<http://www.analog.com/support>.

From there you can:

- Access the EngineerZone DSP Support Forum where Analog Devices support team members and other designers exchange ideas and answer questions
- Search our vast Knowledge Base containing application notes, data sheets, code examples, manuals, and more
- Contact our Technical Support team directly by filling out the support form

Alternately, you can contact Technical Support directly as follows:

- For tools issues, send a description of the problem by e-mail to processor.tools.support@analog.com
- For processor issues, send a description of the problem by e-mail to the Application Engineering group at processor.support@analog.com

Quality Assurance

Analog Devices is committed to providing quality products and services. To continually provide this quality, please contact our Quality Assurance Department directly if you have any concerns at (603) 883-2430, Monday through Friday during normal business hours, or via e-mail at processor.tools.support@analog.com. Our Quality Assurance manager will listen to your concerns and provide a timely and effective solution.

4 REFERENCES

This section describes documentation resources helpful in your application development.

- For information on designing the interface between an Analog Devices SHARC processor and the emulation header on your custom processor target board, refer to Engineer-to-Engineer Note, *Analog Devices JTAG Emulation Technical Reference (EE-68)*, available from the Analog Devices Web site.
- For information on the architecture and system interface of the Analog Devices processor, refer to the appropriate Analog Devices processor's hardware reference manual.
- For processor timing specification and other hardware design information, refer to the appropriate processor's data sheet.
- For complete information on software development tools (assembler, compiler, linker, and so on), refer to documentation included with CrossCore Embedded Studio or VisualDSP++. This information also is available in the online help and PDF format in the `Docs` folder.

- For information about your development platform, refer to your operating system manuals and hardware system manuals.
- For information about digital signal processing theory and applications, consult:
 - Higgins. *Digital Signal Processing In VLSI*. Prentice-Hall, 1990.
 - Oppenheim and Schaffer. *Digital Signal Processing*. Prentice-Hall, 1975.

I INDEX

Numerics

1.8V LED, [2-1](#), [2-3](#)
2.5V LED, [2-1](#), [2-3](#)
3.3/5V LED, [2-2](#), [2-3](#)

A

assembly, [1-2](#)
auto detection mode, [1-14](#)

B

board LEDs, [2-4](#)

C

cables, [1-2](#)
CMOS signals, [1-14](#)
Configurator utility, [1-11](#)
connecting USB cable, [1-4](#)
contents, emulator package, [1-2](#)
custom processor boards, [2-5](#)

D

data sheets, [4-1](#)
default setting, [1-12](#)
designing custom boards, [2-5](#)
Device Manager window, [1-5](#)
digital signal processing theory, [4-2](#)
documentation resources, [4-1](#)
drivers, [1-5](#)

E

EE-175, [1-2](#), [1-16](#)
EE-68, [1-7](#), [2-5](#), [4-1](#)
emulator troubleshooting, [1-2](#), [1-16](#)
enable LED, [2-2](#), [2-3](#)

F

factory default setting, [1-12](#), [1-13](#)
frequency, [2-5](#)
full/high speed USB port, [-viii](#), [1-3](#)

H

hardware
 description, [2-1](#)
 references, [4-1](#)
high-speed USB device, [vii](#)
HPPCI-ICE
 installation, [1-4](#)
 JTAG I/O voltage detection, [1-11](#)
 LEDs, [2-2](#)
 legacy mode, [1-12](#)
 mechanical specifications, [2-5](#)
 voltage support, [viii](#)

I

installation tasks, [1-3](#)
IOVDD input, [1-13](#)
I/O voltage, [vii](#), [viii](#)

Index

J

JTAG

- clock frequency, [viii](#), [2-5](#)
 - See also* TCK
 - daughter card, [1-2](#)
 - frequency selection, [1-8](#)
 - header, [1-11](#), [1-14](#), [2-5](#)
 - port, [2-5](#)
 - signals, [1-11](#), [1-14](#)
 - voltage I/O detection, [1-11](#)
- JTAG Frequency Selection dialog box, [1-7](#), [1-10](#)

L

LEDs

- 1.8V LED, [2-1](#), [2-3](#)
 - 2.5V LED, [2-1](#), [2-3](#)
 - 3.3/5V LED, [2-2](#), [2-3](#)
 - enable LED, [2-2](#)
 - HPPCI-ICE, [2-2](#)
 - HPUSB/USB ICE, [2-1](#)
- legacy mode, [1-13](#)

M

- multiprocessor support, [vii](#), [viii](#)

O

- operating systems, [1-3](#)

P

- PC configuration, [1-2](#)
- PCI based emulators, *See* HPPCI-ICE
- PCI slot, [1-3](#)
- plug-n-play, [vii](#), [viii](#)

pod

- assembly, [1-2](#)
- cable, [1-5](#)
- LEDs, [2-2](#)

Q

- quality assurance, [3-2](#)

S

- saving selected frequency, [1-10](#)
- session restarting, [1-10](#)
- status, [1-10](#)

T

- technical support, [x](#), [3-1](#)
- Test Clock signal (TCK), [1-8](#), [1-10](#)
- testing JTAG frequency, [1-10](#)

U

USB based emulators

- installing, [1-3](#)
 - LEDs, [2-1](#)
 - legacy mode, [1-11](#)
 - USB port, [1-3](#)
 - voltage support, [viii](#)
- USB port, [1-4](#)

V

- VDDIO signal, [1-11](#), [1-14](#)
- verifying driver installation, [1-5](#)
- voltage
 - compliance, [1-14](#)
 - compliance levels, [viii](#), [1-14](#)

Данный компонент на территории Российской Федерации

Вы можете приобрести в компании MosChip.

Для оперативного оформления запроса Вам необходимо перейти по данной ссылке:

<http://moschip.ru/get-element>

Вы можете разместить у нас заказ для любого Вашего проекта, будь то серийное производство или разработка единичного прибора.

В нашем ассортименте представлены ведущие мировые производители активных и пассивных электронных компонентов.

Нашей специализацией является поставка электронной компонентной базы двойного назначения, продукции таких производителей как XILINX, Intel (ex.ALTERA), Vicor, Microchip, Texas Instruments, Analog Devices, Mini-Circuits, Amphenol, Glenair.

Сотрудничество с глобальными дистрибьюторами электронных компонентов, предоставляет возможность заказывать и получать с международных складов практически любой перечень компонентов в оптимальные для Вас сроки.

На всех этапах разработки и производства наши партнеры могут получить квалифицированную поддержку опытных инженеров.

Система менеджмента качества компании отвечает требованиям в соответствии с ГОСТ Р ИСО 9001, ГОСТ РВ 0015-002 и ЭС РД 009

Офис по работе с юридическими лицами:

105318, г.Москва, ул.Щербаковская д.3, офис 1107, 1118, ДЦ «Щербаковский»

Телефон: +7 495 668-12-70 (многоканальный)

Факс: +7 495 668-12-70 (доб.304)

E-mail: info@moschip.ru

Skype отдела продаж:

moschip.ru

moschip.ru_4

moschip.ru_6

moschip.ru_9