

Applications

- Military radar
- Civilian radar
- Professional and military radio communications
- Test instrumentation
- Wideband or narrowband amplifiers
- GPS Communications
- Avionics



Product Features

- Frequency: DC to 2.0 GHz
- Output Power (P_{3dB}): 260 W at 1.2 GHz
- Linear Gain: 18 dB at 1.2 GHz
- Operating Voltage: 36 V
- Low thermal resistance package

Functional Block Diagram

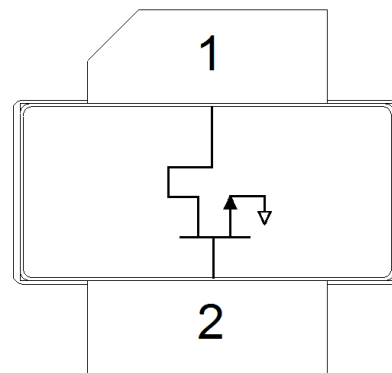

General Description

The TriQuint T1G2028536-FS is a 285 W (P_{3dB}) discrete GaN on SiC HEMT which operates from DC to 2 GHz. The device is constructed with TriQuint's proven TQGaN25HV process, which features advanced field plate techniques to optimize power and efficiency at high drain bias operating conditions. This optimization can potentially lower system costs in terms of fewer amplifier line-ups and lower thermal management costs.

Lead-free and ROHS compliant

Evaluation boards are available upon request.

Pin Configuration

| Pin No. | Label |
|---------|----------------|
| 1 | V_D / RF OUT |
| 2 | V_G / RF IN |
| Flange | Source |

Ordering Information

| Part | ECCN | Description |
|--------------------|-------|-----------------------------------|
| T1G2028536-FS | EAR99 | Packaged part Flangeless |
| T1G2028536-FS-EVB1 | EAR99 | 1.2 – 1.4 GHz Evaluation Board |

Absolute Maximum Ratings

| Parameter | Value |
|---|-----------------------------|
| Breakdown Voltage (V_{DG}) | 145 V (Min.) |
| Drain Gate Voltage (V_{DG}) | 48 V |
| Gate Voltage Range (V_G) | -7 to 0 V |
| Drain Current (I_D) | 24 A |
| Gate Current (I_G) | -57 to 67 mA |
| Power Dissipation (P_D) | 260 W |
| RF Input Power, CW, $T = 25^\circ\text{C}$ (P_{IN}) | 47 dBm |
| Channel Temperature (T_{CH}) | 275 $^\circ\text{C}$ |
| Mounting Temperature (30 Seconds) | 320 $^\circ\text{C}$ |
| Storage Temperature | -40 to 150 $^\circ\text{C}$ |

Operation of this device outside the parameter ranges given above may cause permanent damage. These are stress ratings only, and functional operation of the device at these conditions is not implied.

Recommended Operating Conditions

| Parameter | Value |
|--------------------------------------|----------------------------|
| Drain Voltage (V_D) | 36 V (Typ.) |
| Drain Quiescent Current (I_{DQ}) | 576 mA (Typ.) |
| Peak Drain Current (I_D) | 13.3 A (Typ.) |
| Gate Voltage (V_G) | -3.0 V (Typ.) |
| Channel Temperature (T_{CH}) | 250 $^\circ\text{C}$ (Max) |
| Power Dissipation, CW (P_D) | 226 W |
| Power Dissipation, Pulse (P_D) | 288 W |

Electrical specifications are measured at specified test conditions. Specifications are not guaranteed over all recommended operating conditions.

RF Characterization – Load Pull Performance at 1.0 GHz ⁽¹⁾

Test conditions unless otherwise noted: $T_A = 25^\circ\text{C}$, $V_D = 36\text{ V}$, $I_{DQ} = 576\text{ mA}$

| Symbol | Parameter | Min | Typical | Max | Units |
|-------------|---|-----|---------|-----|-------|
| G_{LIN} | Linear Gain | | 20.8 | | dB |
| P_{3dB} | Output Power at 3 dB Gain Compression | | 316.0 | | W |
| DE_{3dB} | Drain Efficiency at 3 dB Gain Compression | | 66.7 | | % |
| PAE_{3dB} | Power-Added Efficiency at 3 dB Gain | | 65.6 | | % |
| G_{3dB} | Gain at 3 dB Compression | | 17.8 | | dB |

Notes:

- $V_{DS} = 36\text{ V}$, $I_{DQ} = 576\text{ mA}$; Pulse: 300 μs , 10%

RF Characterization – Load Pull Performance at 2.0 GHz ⁽¹⁾

Test conditions unless otherwise noted: $T_A = 25^\circ\text{C}$, $V_D = 36\text{ V}$, $I_{DQ} = 576\text{ mA}$

| Symbol | Parameter | Min | Typical | Max | Units |
|-------------|---|-----|---------|-----|-------|
| G_{LIN} | Linear Gain | | 19.4 | | dB |
| P_{3dB} | Output Power at 3 dB Gain Compression | | 268.9 | | W |
| DE_{3dB} | Drain Efficiency at 3 dB Gain Compression | | 56.3 | | % |
| PAE_{3dB} | Power-Added Efficiency at 3 dB Gain | | 55.1 | | % |
| G_{3dB} | Gain at 3 dB Compression | | 16.4 | | dB |

Notes:

- $V_{DS} = 36\text{ V}$, $I_{DQ} = 576\text{ mA}$; Pulse: 300 μs , 10%

RF Characterization – Performance at 1.2 GHz ^(1, 2)

Test conditions unless otherwise noted: $T_A = 25\text{ }^\circ\text{C}$, $V_D = 36\text{ V}$, $I_{DQ} = 576\text{ mA}$

| Symbol | Parameter | Min | Typical | Max | Units |
|------------|---|-------|---------|-----|-------|
| G_{LIN} | Linear Gain | 17.0 | 18.7 | | dB |
| P_{3dB} | Output Power at 3 dB Gain Compression | 230.0 | 264.5 | | W |
| DE_{3dB} | Drain Efficiency at 3 dB Gain Compression | 49.0 | 54.0 | | % |
| G_{3dB} | Gain at 3 dB Compression | 14.0 | 15.7 | | dB |

Notes:

1. Performance at 1.2 GHz in the 1.2 to 1.4 GHz Evaluation Board
2. $V_{DS} = 36\text{ V}$, $I_{DQ} = 576\text{ mA}$; Pulse: 300 μs , 10%

RF Characterization – Impedance Mismatch Ruggedness at 1.2 GHz ⁽¹⁾

Test conditions unless otherwise noted: $T_A = 25\text{ }^\circ\text{C}$, $V_D = 36\text{ V}$, $I_{DQ} = 576\text{ mA}$

| Symbol | Parameter | Typical |
|--------|-------------------------------|---------|
| VSWR | Impedance Mismatch Ruggedness | 10:1 |

Notes:

1. $V_{DS} = 36\text{ V}$, $I_{DQ} = 576\text{ mA}$, CW at P_{1dB}

Thermal and Reliability Information

| Parameter | Test Conditions | Value | Units |
|--------------------------------------|------------------|-------|-------|
| Thermal Resistance (θ_{JC}) | DC at 85 °C Case | 0.73 | °C/W |
| Channel Temperature (T_{CH}) | | 250 | °C |

Notes:

Thermal resistance measured to bottom of package

Median Lifetime

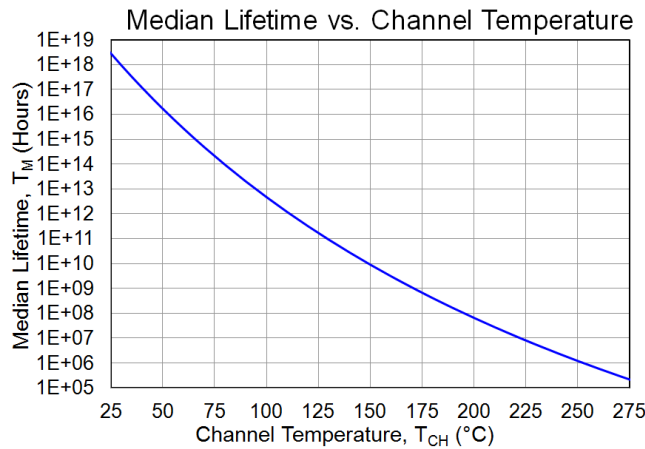

Maximum Channel Temperature

$T_{BASE} = 85^\circ\text{C}$, $P_D = 288\text{ W}$

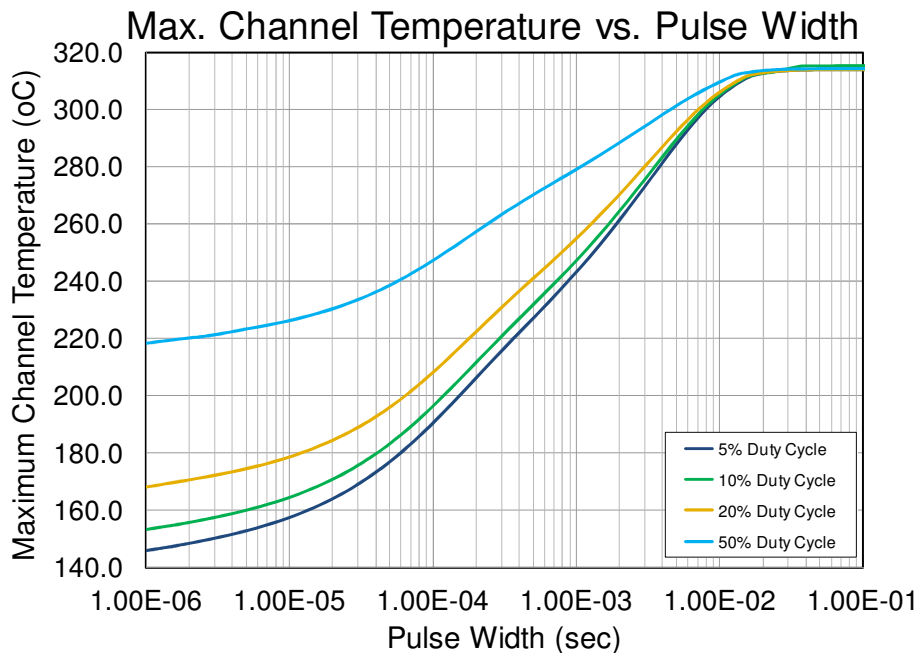

Load Pull Smith Charts (1, 2)

RF performance that the device typically exhibits when placed in the specified impedance environment. The impedances are not the impedances of the device, they are the impedances presented to the device via an RF circuit or load-pull system. The impedances listed follow an optimized trajectory to maintain high power and high efficiency.

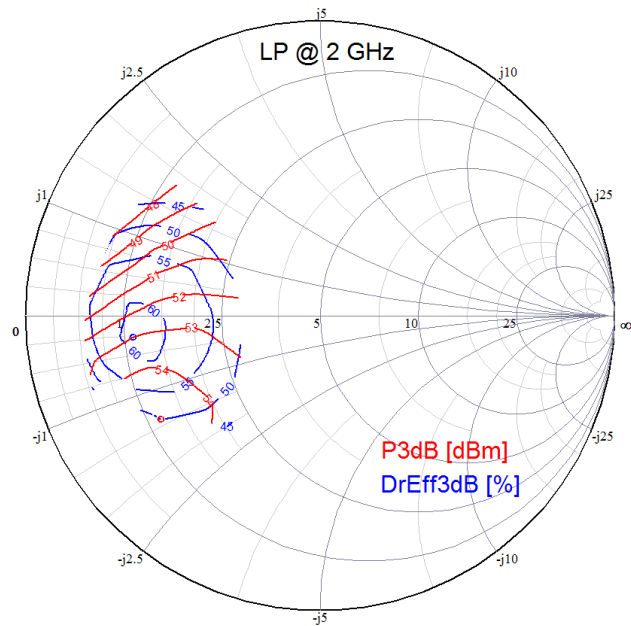
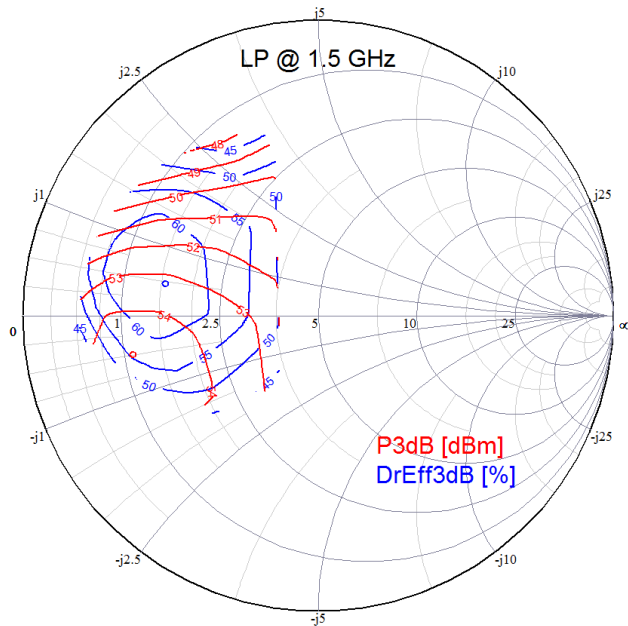
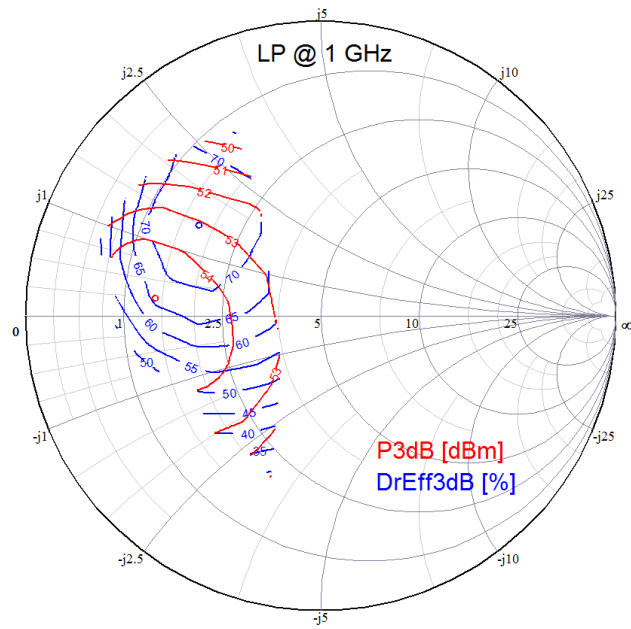
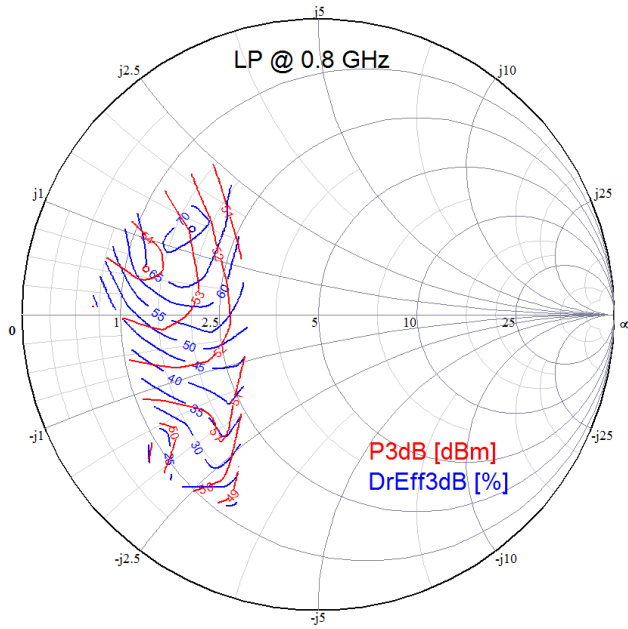

Notes:

1. Test Conditions: $V_{DS} = 36\text{ V}$, $I_{DQ} = 576\text{ mA}$
2. Test Signal: Pulse Width = 100 μsec , Duty Cycle = 20%

Typical Performance

Performance is based on compromised impedance point and measured at DUT reference plane.

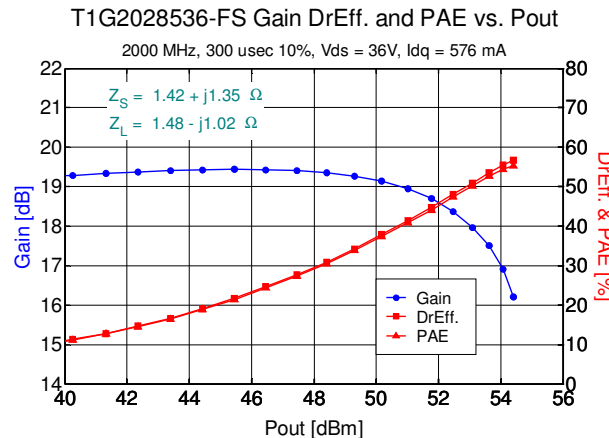
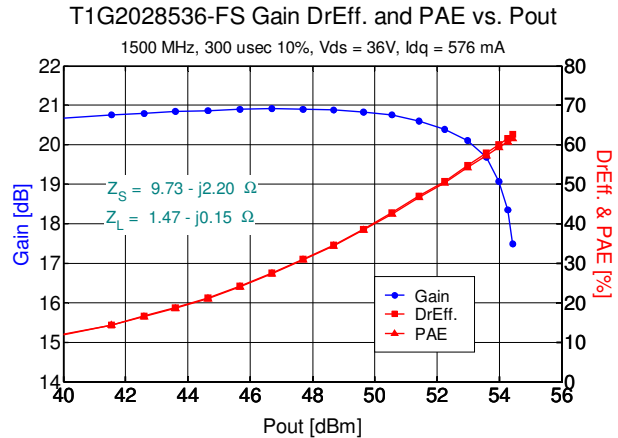
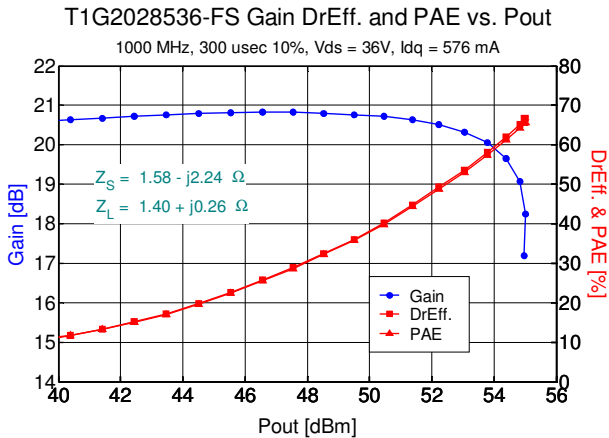
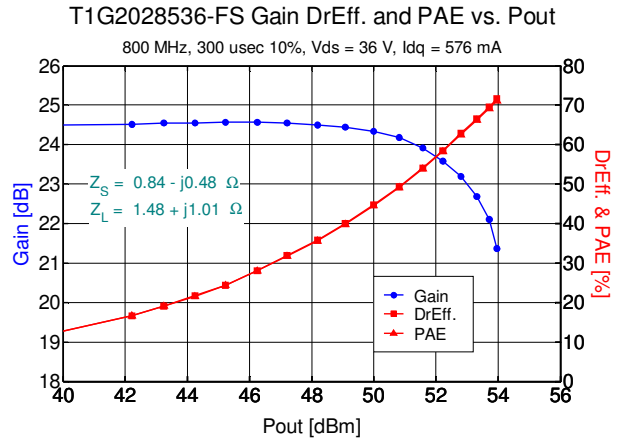
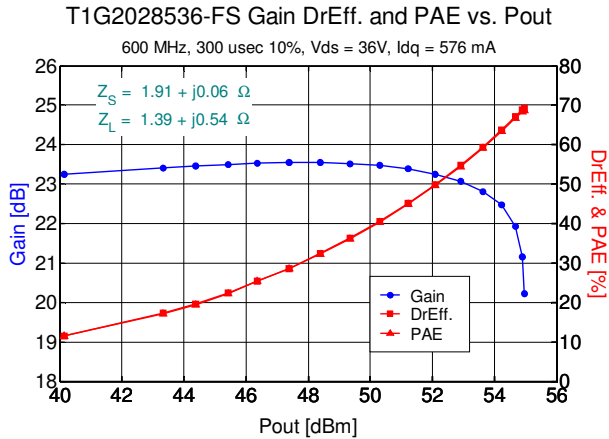

Performance Over Temperature (1, 2)

Performance measured in TriQuint's 1.2 GHz to 1.4 GHz Evaluation Board at 3 dB compression.

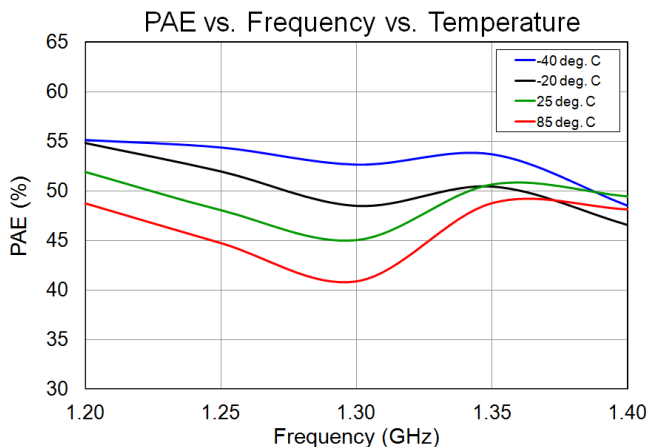
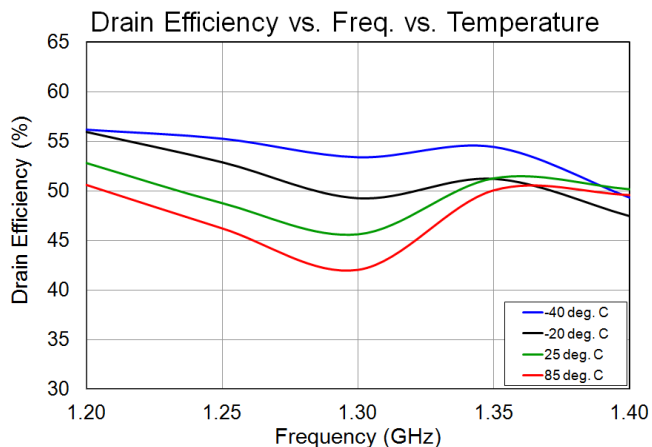
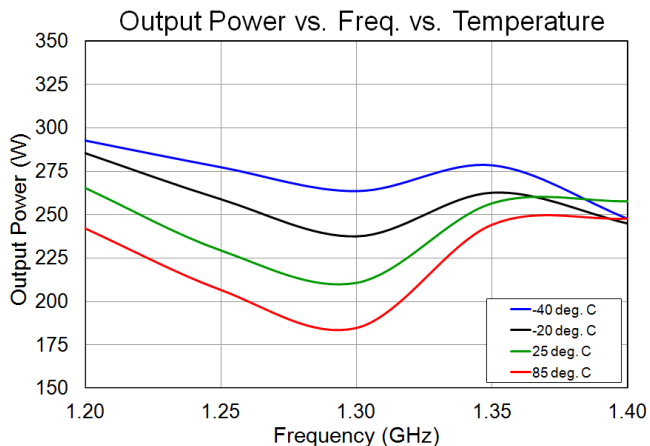
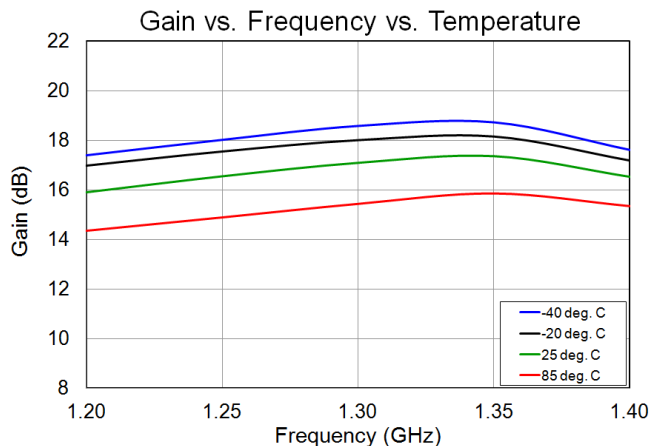

Notes:

1. Test Conditions: $V_{DS} = 36\text{ V}$, $I_{DQ} = 576\text{ mA}$
2. Test Signal: Pulse Width = 300 μs , Duty Cycle = 10%

Evaluation Board Performance ^(1, 2)

Performance at 3 dB Compression

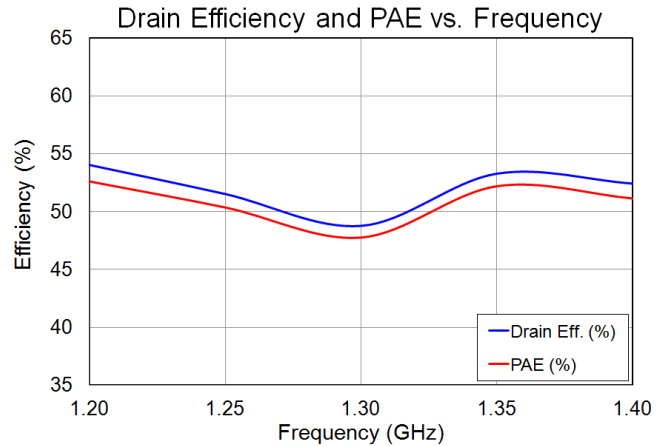
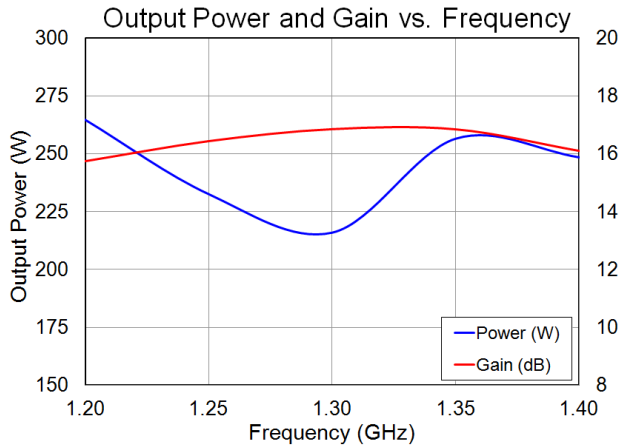

Notes:

1. Test Conditions: $V_{DS} = 36\text{ V}$, $I_{DQ} = 576\text{ mA}$
2. Test Signal: Pulse Width = 300 μs , Duty Cycle = 10 %

Application Circuit

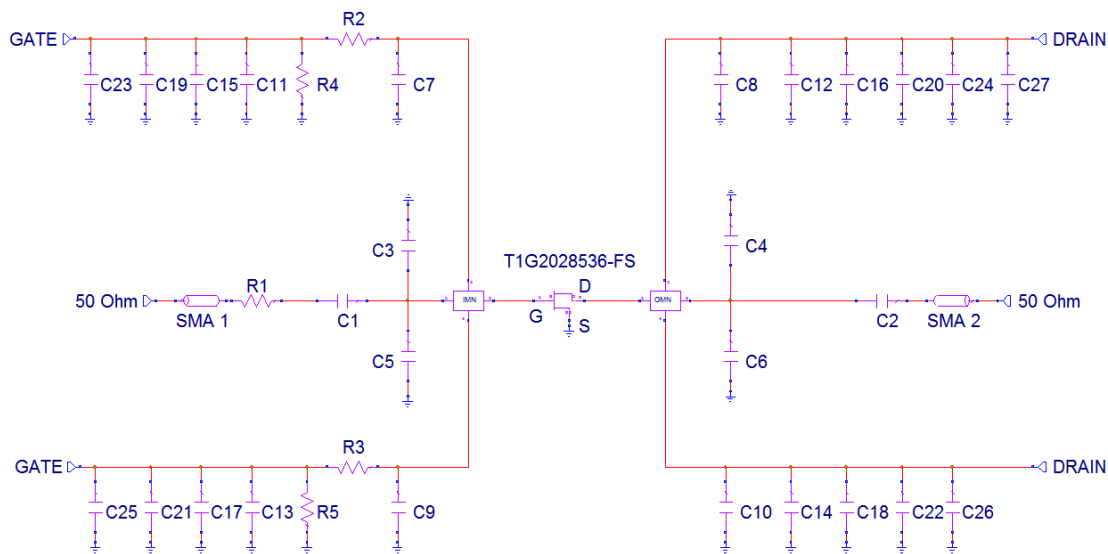

Bias-up Procedure

- Set gate voltage (V_G) to -5.0V
- Set drain voltage (V_D) to 36 V
- Slowly increase V_G until quiescent I_D is 576 mA.
- Apply RF signal

Bias-down Procedure

- Turn off RF signal
- Turn off V_D and wait 1 second to allow drain capacitor dissipation
- Turn off V_G

Evaluation Board Layout

Top RF layer is 0.020" thick Rogers RO4350, $\epsilon_r = 3.48$. The pad pattern shown has been developed and tested for optimized assembly at TriQuint Semiconductor. The PCB land pattern has been developed to accommodate lead and package tolerances.

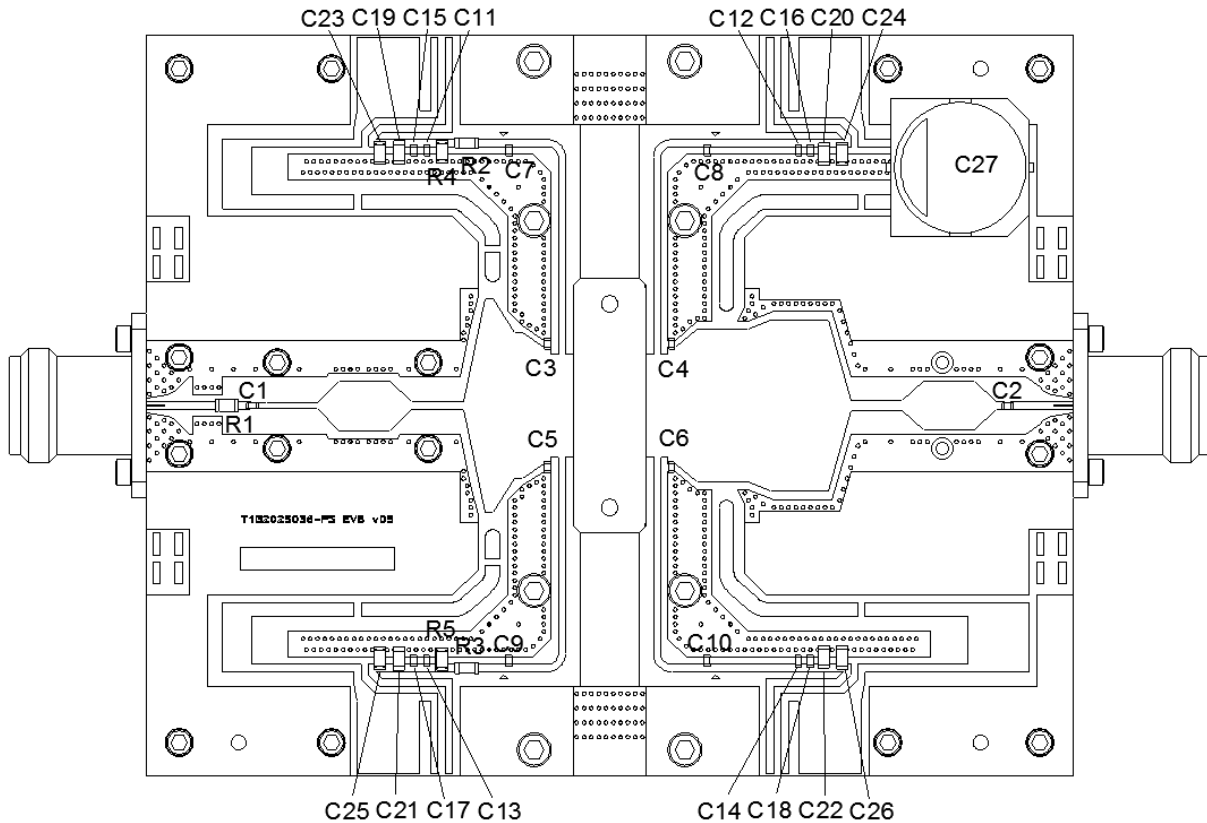

Bill of Materials

| Reference Design | Value | Qty | Manufacturer | Part Number |
|-------------------------|-----------|-----|------------------|-------------------|
| C1, C2, C7, C8, C9, C10 | 27 pF | 6 | ATC | 600S270FW250XT |
| C3, C5 | 3.9 pF | 2 | ATC | 600S3R9AW250XT |
| C4, C6 | 4.7 pF | 2 | ATC | 600S4R7AW250XT |
| C11, C12, C13, C14 | 2400 pF | 4 | Murata | C08BL242X-5UN-X0T |
| C15, C16, C17, C18 | 100 pF | 4 | ATC | 600S101FW250XT |
| C19, C20, C21, C22 | 0.01 uF | 4 | Kemet | C1206C103KRAC7800 |
| C23, C24, C25, C26 | 1 uF | 4 | Allied | 18121C105KAT2A |
| C27 | 330 uF | 1 | Cornell Dubilier | AFK337M2AR44T-F |
| R1, R2, R3 | 12.1 ohms | 3 | Vishay Dale | CRCW120612R1FKTA |
| R4, R5 | 1000 ohms | 2 | Vishay Dale | CRCW12061K00FKTA |

Pin Layout

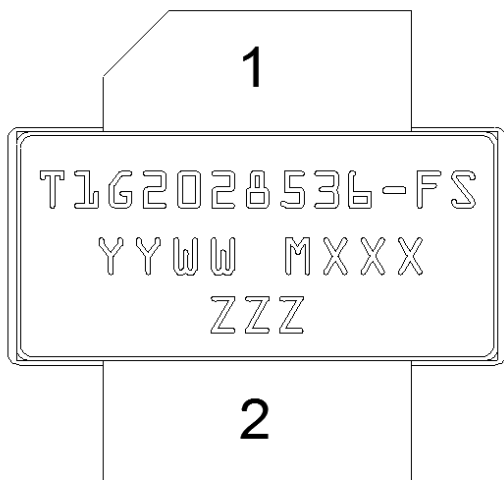

TOP VIEW

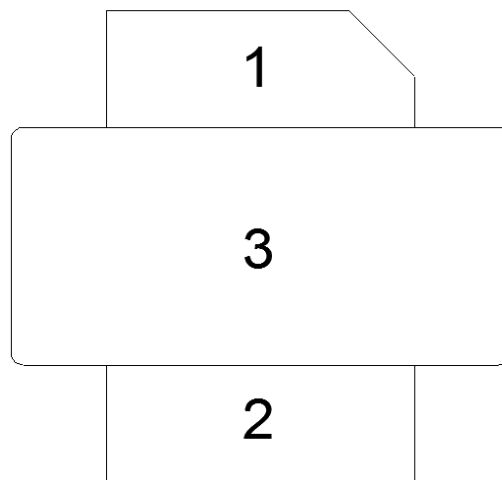

BOTTOM VIEW

Note:

The T1G2028536-FS will be marked with the “T1G2028536-FS” designator and a lot code marked below the part designator. The “YY” represents the last two digits of the calendar year the part was manufactured, the “WW” is the work week of the assembly lot start, the “MXXX” is the production lot number, and the “ZZZ” is an auto-generated serial number.

Pin Description

| Pin | Symbol | Description |
|-----|----------------|---|
| 1 | V_D / RF OUT | Drain voltage / RF Output matched to 50 ohms; see EVB Layout on page 9 as an example. |
| 2 | V_G / RF IN | Gate voltage / RF Input matched to 50 ohms; see EVB Layout on page 9 as an example. |
| 3 | Flange | Source connected to ground; see EVB Layout on page 9 as an example. |

Notes:

Thermal resistance measured to bottom of package

Mechanical Information

All dimensions are in millimeters.

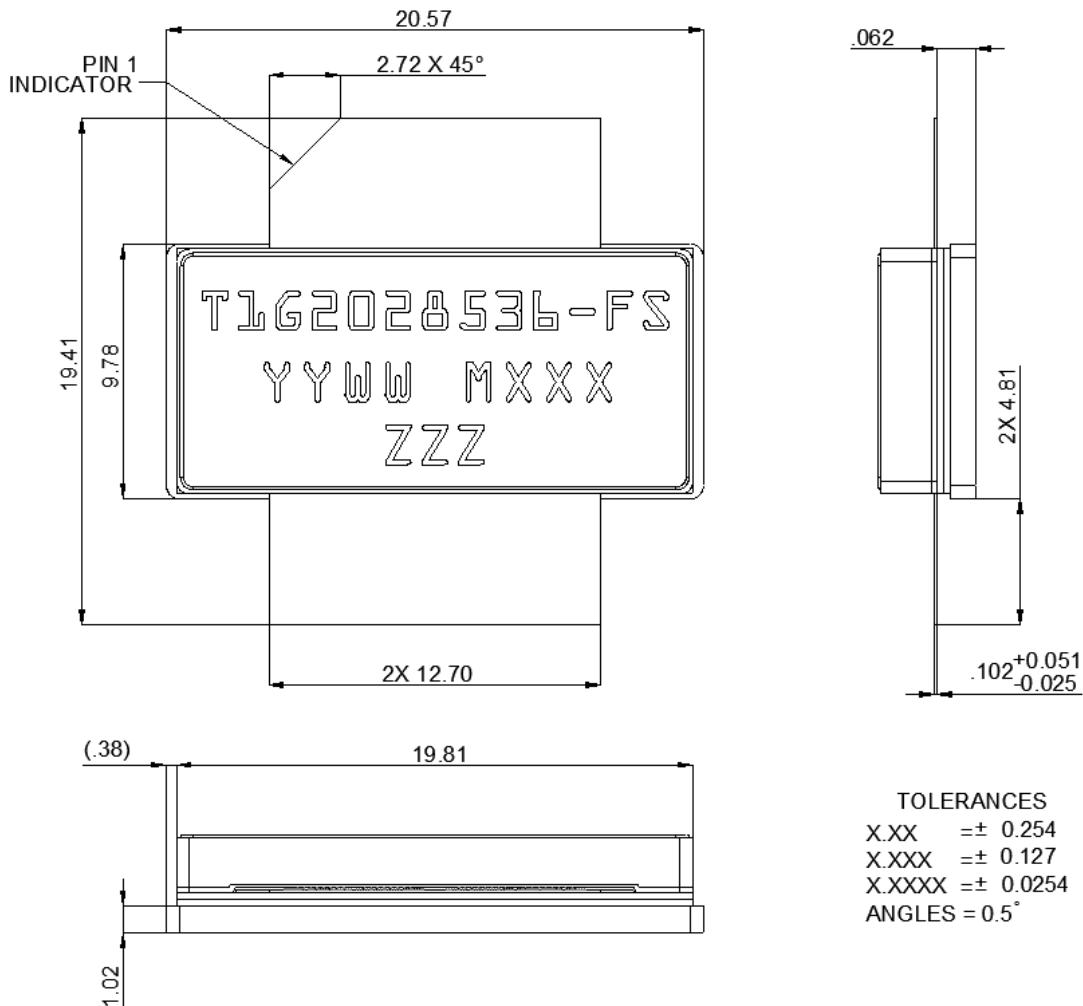

Note:

This package is lead-free/RoHS-compliant. The plating material on the leads is NiAu. It is compatible with both lead-free (maximum 260 °C reflow temperature) and tin-lead (maximum 245 °C reflow temperature) soldering processes.

Product Compliance Information

ESD Sensitivity Ratings



Caution! ESD-Sensitive Device

ESD Rating: TBD
 Value: TBD
 Test: Human Body Model (HBM)
 Standard: JEDEC Standard JESD22-A114

MSL Rating

Level 3 at +260 °C convection reflow
 The part is rated Moisture Sensitivity Level 3 at 260°C per JEDEC standard IPC/JEDEC J-STD-020.

ECCN

US Department of Commerce EAR99

Solderability

Compatible with the latest version of J-STD-020, Lead free solder, 260° C

RoHS Compliance

This part is compliant with EU 2002/95/EC RoHS directive (Restrictions on the Use of Certain Hazardous Substances in Electrical and Electronic Equipment).

This product also has the following attributes:

- Lead Free
- Halogen Free (Chlorine, Bromine)
- Antimony Free
- TBBP-A (C₁₅H₁₂Br₄O₂) Free
- PFOS Free
- SVHC Free

Recommended Soldering Temperature Profile

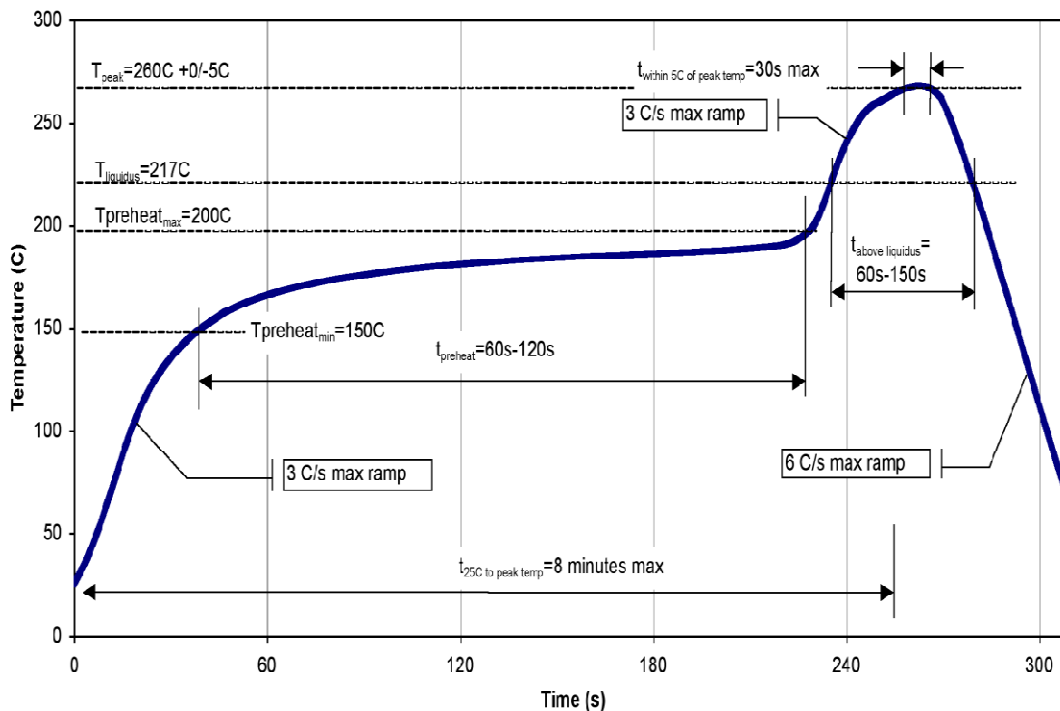

Contact Information

For the latest specifications, additional product information, worldwide sales and distribution locations, and information about TriQuint:

Web: www.triquint.com

Tel: +1.972.994.8465

Email: info-sales@triquint.com

Fax: +1.972.994.8504

For technical questions and application information:

Email: info-products@triquint.com

Important Notice

The information contained herein is believed to be reliable. TriQuint makes no warranties regarding the information contained herein. TriQuint assumes no responsibility or liability whatsoever for any of the information contained herein. TriQuint assumes no responsibility or liability whatsoever for the use of the information contained herein. The information contained herein is provided "AS IS, WHERE IS" and with all faults, and the entire risk associated with such information is entirely with the user. All information contained herein is subject to change without notice. Customers should obtain and verify the latest relevant information before placing orders for TriQuint products. The information contained herein or any use of such information does not grant, explicitly or implicitly, to any party any patent rights, licenses, or any other intellectual property rights, whether with regard to such information itself or anything described by such information.

TriQuint products are not warranted or authorized for use as critical components in medical, life-saving, or life-sustaining applications, or other applications where a failure would reasonably be expected to cause severe personal injury or death.

Данный компонент на территории Российской Федерации

Вы можете приобрести в компании MosChip.

Для оперативного оформления запроса Вам необходимо перейти по данной ссылке:

<http://moschip.ru/get-element>

Вы можете разместить у нас заказ для любого Вашего проекта, будь то серийное производство или разработка единичного прибора.

В нашем ассортименте представлены ведущие мировые производители активных и пассивных электронных компонентов.

Нашей специализацией является поставка электронной компонентной базы двойного назначения, продукции таких производителей как XILINX, Intel (ex.ALTERA), Vicor, Microchip, Texas Instruments, Analog Devices, Mini-Circuits, Amphenol, Glenair.

Сотрудничество с глобальными дистрибьюторами электронных компонентов, предоставляет возможность заказывать и получать с международных складов практически любой перечень компонентов в оптимальные для Вас сроки.

На всех этапах разработки и производства наши партнеры могут получить квалифицированную поддержку опытных инженеров.

Система менеджмента качества компании отвечает требованиям в соответствии с ГОСТ Р ИСО 9001, ГОСТ РВ 0015-002 и ЭС РД 009

Офис по работе с юридическими лицами:

105318, г.Москва, ул.Щербаковская д.3, офис 1107, 1118, ДЦ «Щербаковский»

Телефон: +7 495 668-12-70 (многоканальный)

Факс: +7 495 668-12-70 (доб.304)

E-mail: info@moschip.ru

Skype отдела продаж:

moschip.ru

moschip.ru_4

moschip.ru_6

moschip.ru_9