

spec ref	-	dr	Chris Gieski	2010/08/27	projection	MM	size	A2	scale	4:1
tolerance std	ASME Y14.5	eng	De-Ming Lu	2014/06/05			ecn no	ELX-DG-17838-1		
TOLERANCES UNLESS OTHERWISE SPECIFIED		chr	-	rel level			Released			
surface	linear	appr	Pei-Ming Zheng	2014/06/05	product family	HPCE	rel level	Blue		
ASME Y14.5	angular	0°	±0°	0.X ±0.3	0.XX ±0.10	0.XXX ±0.050	dwg no	10115859		
		www.fci.com		cat. no.	-		Product - Customer Drw	sheet 1 of 4		

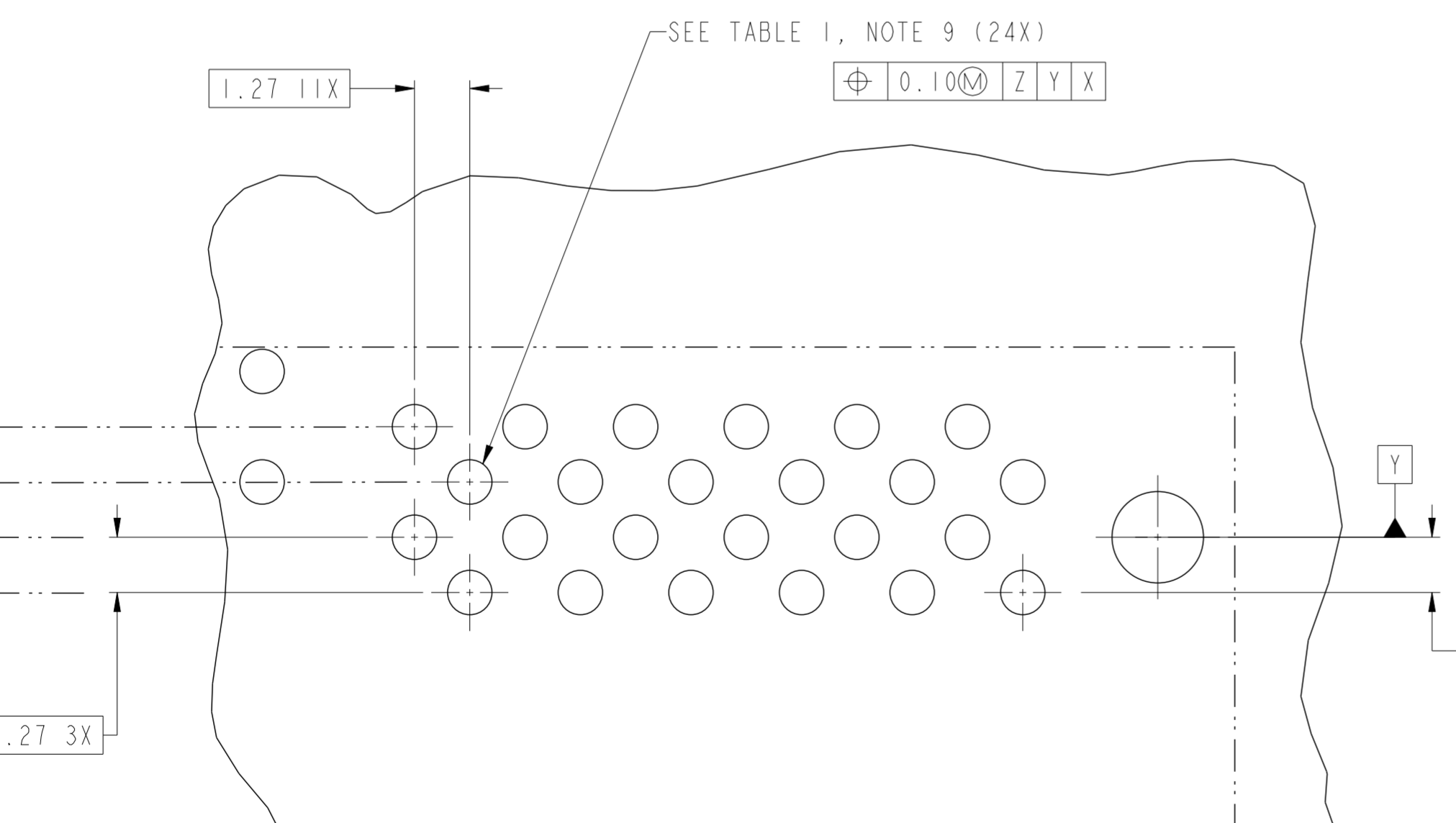

**RECOMMENDED PCB LAYOUT  
VIEWED FROM CONNECTOR SIDE**

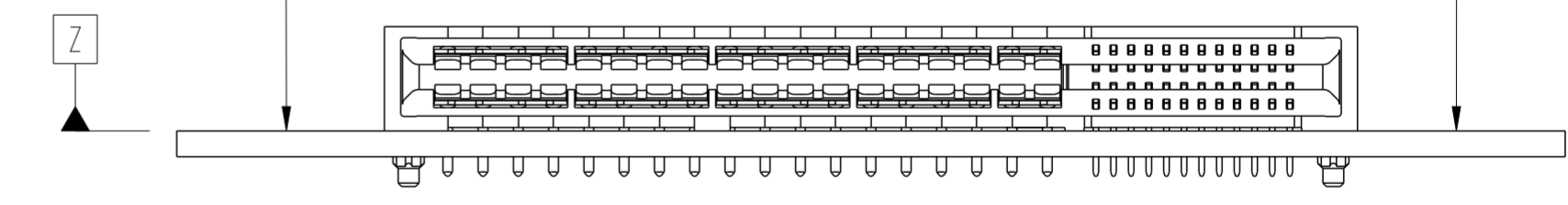

**DETAIL K  
SCALE 8:1**

spec ref	-	dr	Chris Gieski	2010/08/27	projection	MM	size	A2	scale	4:1
tolerance std	ASME Y14.5	eng	De-Ming Lu	2014/06/05			ecn no	ELX-DG-17838-1	rel level	Released
TOLERANCES UNLESS OTHERWISE SPECIFIED		chr	-	product family						
surface	linear	0.X	±0.3		<b>FCI</b> R/A RECT (36P-24S) HIGH POWER CARD EDGE	cat. no.	Product - Customer Drw	sheet 2 of 4	rev D	
	0.XX	±0.10	www.fci.com							
	0.XXX	±0.050								
ASME Y14.5	angular	0°	±°							

Copyright FCI. FCI



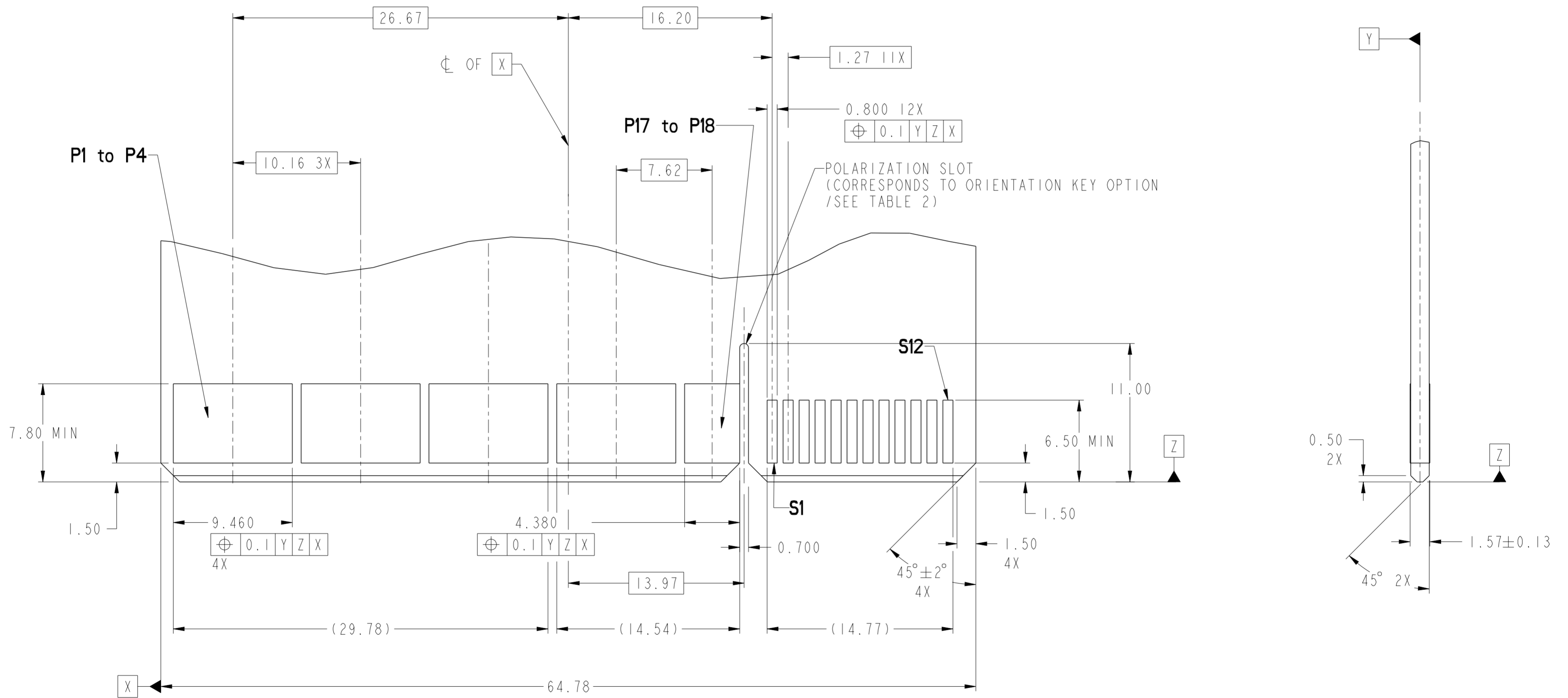

CONTACT TYPE	TOP LAYER DESCRIPTION	TABLE 1 (HPCE / SOLDER TAILS) PLATED THROUGH-HOLE REQUIREMENTS				
		DRILLED HOLE DIAMETER	COPPER THICKNESS	TIN-LEAD THICKNESS	TIN THICKNESS	FINISHED HOLE DIAMETER
POWER & SIGNAL	TIN-LEAD	1.10-1.16 (1.15 DRILL)	0.025 - 0.050	0.005 - 0.015	--	0.94 - 1.10
	IMMERSION TIN	1.10-1.16 (1.15 DRILL)	0.025 - 0.050	--	0.9 - 1.5um	0.94 - 1.10
	COPPER (SEE NOTE 8)	1.10-1.16 (1.15 DRILL)	0.025 - 0.050	--	--	0.94 - 1.10



### RECOMMENDED MATING BOARD FOOTPRINT



spec ref	-	dr	Chris Gieski	2010/08/27	projection	MM	size	A2	scale	4:1
tolerance std	ASME Y14.5	eng	De-Ming Lu	2014/06/05	chr	-	ecn no	ELX-DG-17838-1	rel level	Released
surface	linear	appr	Pei-Ming Zheng	2014/06/05	product family	HPCE	dwg no	10115859	rev	D
ASME Y14.5	angular	0°	±°	0.X	±0.3	0.XX	±0.10	0.XXX	±0.050	

HPCE PART NUMBER (TABLE 2)

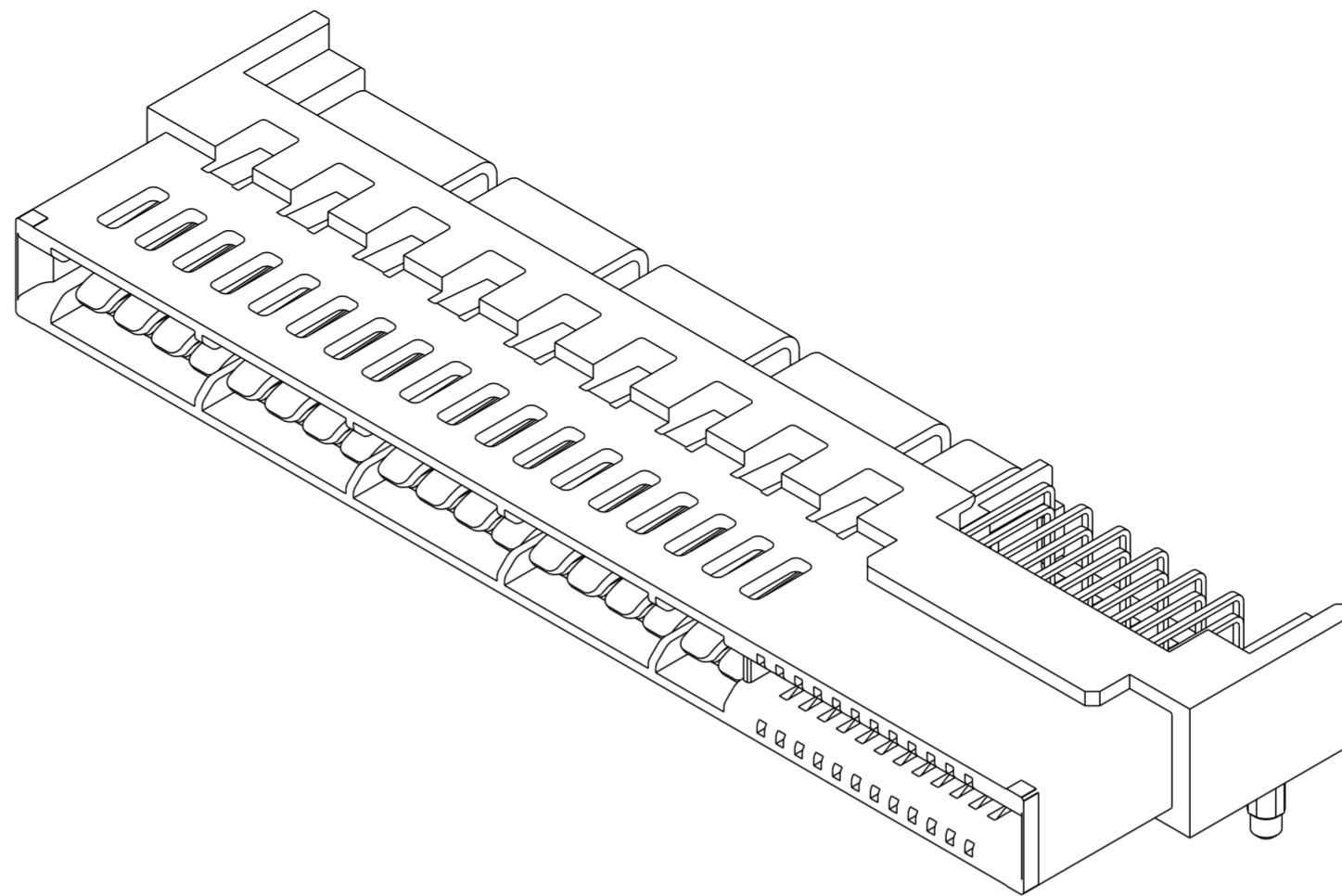
PART NUMBER	TAIL TYPE	HOLD-DOWN OPTION	ORIENTATION KEY	DIM "A" TYPICAL TAIL LENGTH	
10115859-001LF	SOLDER TAIL	NO	YES	3.25±0.25	
10115859-002LF			NO		
10115859-003LF		YES	YES		
10115859-004LF			NO		
10115859-005LF		NO	YES		4.05±0.25
10115859-006LF			NO		
10115859-007LF		YES	YES		
10115859-008LF			NO		
10115859-009LF		NO	YES	4.85±0.25	
10115859-010LF			NO		
10115859-011LF		YES	YES		
10115859-012LF			NO		
10115859-013LF 		NO	YES		2.60±0.25
10115859-014LF 			NO		
10115859-015LF 			YES		
10115859-016LF 			NO		



NOTES:

- CONNECTOR MATERIALS:  
HOUSING: HIGH TEMPERATURE THERMAL PLASTIC, BLACK  
UL 94V-0 COMPLIANT  
CONTACTS: HIGH PERFORMANCE COPPER ALLOY.
- CONTACT FINISH REF. GS-12-604 SECTION 5.2.
- PRODUCT SPECIFICATION: GS-12-604.
- APPLICATION SPECIFICATION: GS-20-128.
- PRODUCT MARKING (FCI - PART NUMBER & DATE CODE) ON HOUSING IN AREA SHOWN.
- PACKAGING MEETS FCI SPECIFICATION GS-14-937.
- HOUSING COMPONENT WILL WITHSTAND EXPOSURE TO 260°C PEAK TEMPERATURE FOR 60 SECONDS IN A CONVECTION, INFRA-RED, OR VAPOR PHASE REFLOW OVEN.
- COPPER PLATING THICKNESS IN CENTER OF VIA-HOLE CAN BE NO MORE THAN 0.003 LESS THAN OTHER AREAS.
- ALL HOLE SIZES ARE FINISHED HOLE SIZES.
- MOUNTING HOLES ARE UNPLATED  
Ø 2.10 +/- 0.1 FOR SOLDER TAILS
-  A  SYMBOL WILL BE NEXT TO ANY DIMENSION, VIEW, OR NOTE WHICH HAS BEEN MODIFIED WITH THE CURRENT DRAWING REVISION.

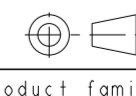

Copyright FCI.

spec ref	-	dr	Chris Gieski	2010/08/27	projection	MM	size	A2	scale	4:1
tolerance std	ASME Y14.5	eng	De-Ming Lu	2014/06/05		←	ecn no	ELX-DG-17838-1		
TOLERANCES UNLESS OTHERWISE SPECIFIED		chr	-	rel level				Released		
surface	linear	appr	Pei-Ming Zheng	2014/06/05	product family	HPCE	dwg no	10115859		
ASME Y14.5	angular	www.fci.com		cat. no.	Product - Customer Drw		rev	D		

## Данный компонент на территории Российской Федерации

### Вы можете приобрести в компании MosChip.

Для оперативного оформления запроса Вам необходимо перейти по данной ссылке:

<http://moschip.ru/get-element>

Вы можете разместить у нас заказ для любого Вашего проекта, будь то серийное производство или разработка единичного прибора.

В нашем ассортименте представлены ведущие мировые производители активных и пассивных электронных компонентов.

Нашей специализацией является поставка электронной компонентной базы двойного назначения, продукции таких производителей как XILINX, Intel (ex.ALTERA), Vicor, Microchip, Texas Instruments, Analog Devices, Mini-Circuits, Amphenol, Glenair.

Сотрудничество с глобальными дистрибьюторами электронных компонентов, предоставляет возможность заказывать и получать с международных складов практически любой перечень компонентов в оптимальные для Вас сроки.

На всех этапах разработки и производства наши партнеры могут получить квалифицированную поддержку опытных инженеров.

Система менеджмента качества компании отвечает требованиям в соответствии с ГОСТ Р ИСО 9001, ГОСТ РВ 0015-002 и ЭС РД 009

### Офис по работе с юридическими лицами:

105318, г.Москва, ул.Щербаковская д.3, офис 1107, 1118, ДЦ «Щербаковский»

Телефон: +7 495 668-12-70 (многоканальный)

Факс: +7 495 668-12-70 (доб.304)

E-mail: [info@moschip.ru](mailto:info@moschip.ru)

Skype отдела продаж:

moschip.ru

moschip.ru\_4

moschip.ru\_6

moschip.ru\_9