

# MULTILAYER FERRITE CHIP BEAD

ACML-0603



RoHS/RoHS II Compliant



1.00 x 0.80 x 0.80mm

## FEATURES:

- Magnetic shielded structure designed to minimize crosstalk
- Multilayer monolithic structure yields high reliability
- Substantial EMI suppression from dozens of MHz to hundreds of MHz
- Wide range of impedance values available

## APPLICATIONS:

- Noise suppression in digital equipment such as computer and its peripheral devices, DVD player, digital camera, TV and communication equipments.

## STANDARD SPECIFICATIONS:

### PARAMETERS

ABRACON P/N:	ACML-0603
Operating temperature:	-55°C to +125°C
Storage temperature:	-55°C to +125°C

Part Number ACML-0603- Impedance Code	Impedance	Frequency	DC resistance	Rated Current
Units	$\Omega \pm 25\%$	MHz	$\Omega$ max	mA max
Symbol	Z	F	R <sub>DC</sub>	I <sub>R</sub>
ACML-0603-060	6	100	0.05	1000
ACML-0603-110	11	100	0.05	1000
ACML-0603-190	19	100	0.05	1000
ACML-0603-220	22	100	0.20	800
ACML-0603-310	31	100	0.05	500
ACML-0603-500	50	100	0.08	500
ACML-0603-600	60	100	0.30	600
ACML-0603-800	80	100	0.16	200
ACML-0603-101	100	100	0.20	200
ACML-0603-121	120	100	0.40	600
ACML-0603-181	180	100	0.30	200
ACML-0603-221	220	100	0.45	500
ACML-0603-301	300	100	0.35	200
ACML-0603-331	330	100	0.50	500
ACML-0603-471	470	100	0.55	400
ACML-0603-501	500	100	0.45	200
ACML-0603-601	600	100	0.45	200
ACML-0603-102	1000	100	0.80	200
ACML-0603-152	1500	100	0.80	200
ACML-0603-202	2000	100	1.00	200

## Test Conditions and Equipments

**I<sub>R</sub>:** Rated current applied when the chip surface temperature rise just 20°C against chip surface temperature.

**Electric power supplier, Electric current meter, Thermometer.**

**Z:** Impedance Analyzer HP4291 or equivalent, 50mV.

**DCR:** LCR Meter HP4263A or equivalent



# MULTILAYER FERRITE CHIP BEAD

ACML-0603



RoHS/RoHS II Compliant

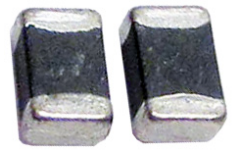

1.00 x 0.80 x 0.80mm

## FREQUENCY CHARACTERISTICS

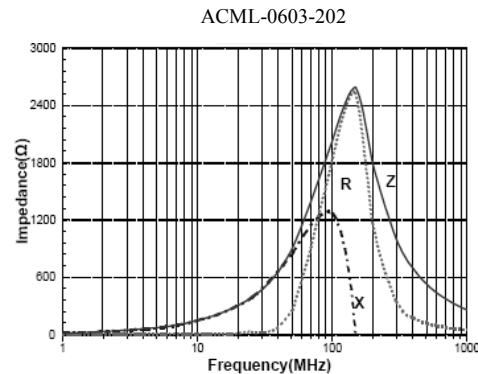
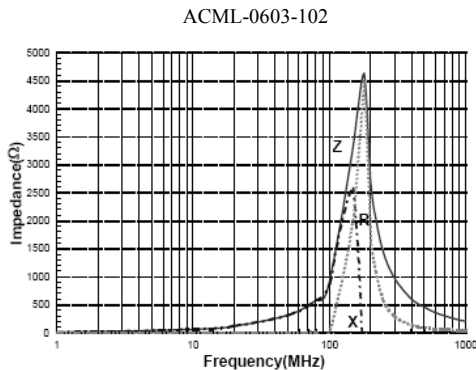
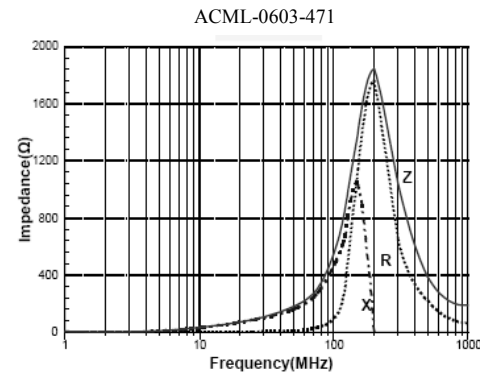
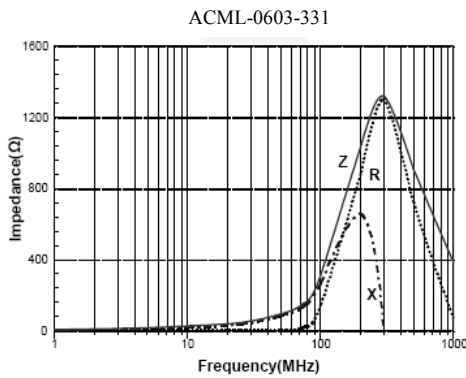
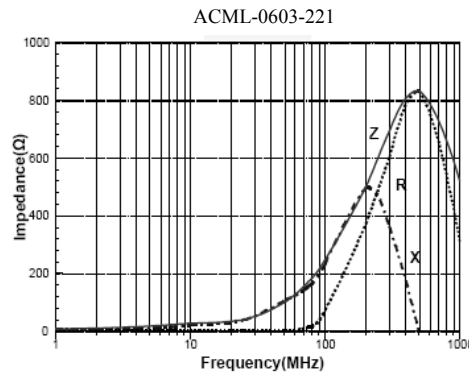
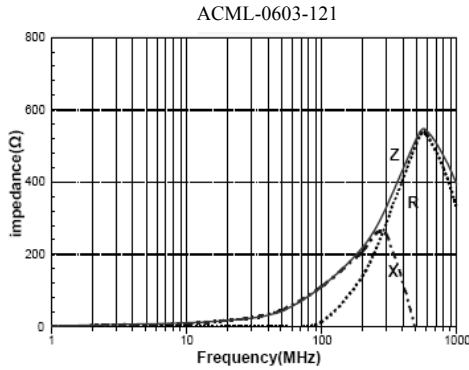
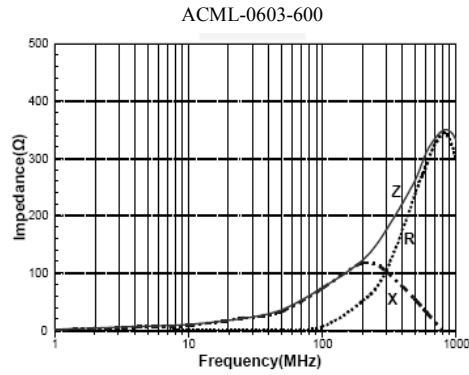
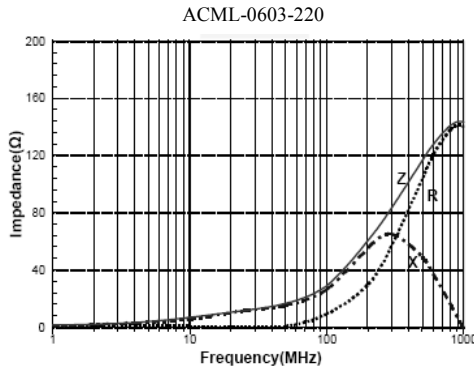

ABRACON IS  
ISO 9001:2008  
CERTIFIED



**ABRACON**  
CORPORATION

Visit [www.abracon.com](http://www.abracon.com) for Terms & Conditions of Sale **Revised: 01.19.14**  
30332 Esperanza, Rancho Santa Margarita, California 92688  
tel 949-546-8000 | fax 949-546-8001 | [www.abracon.com](http://www.abracon.com)

# MULTILAYER FERRITE CHIP BEAD

ACML-0603



RoHS/RoHS II Compliant



1.00 x 0.80 x 0.80mm

## PART NUMBER IDENTIFICATION

ACML-0603-  -

### Impedance Code

Please refer to the Electrical Specification table

### Packaging

T: Tape and Reel  
(4kpcs / reel)

## OUTLINE DIMENSION:

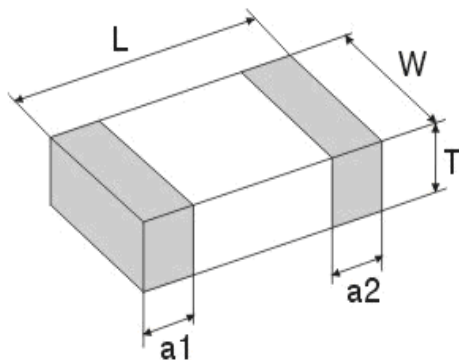

L	W	T	a1, a2
1.60±0.15	0.80±0.15	0.80±0.15	0.30±0.20

## Materials

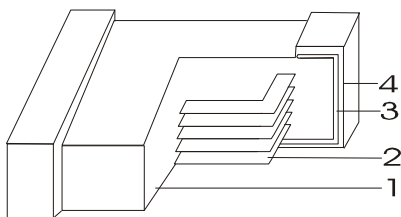

	Part Name	Material
1	Base Material	Ferrite
2	Internal Conductor	Ag
3	Terminal Electrode	Ag
4	Terminal Electrode	Ni-Sn

Dimension: mm

# MULTILAYER FERRITE CHIP BEAD

ACML-0603



RoHS/RoHS II Compliant

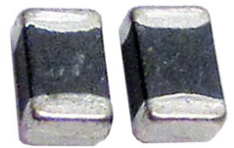

1.00 x 0.80 x 0.80mm

## REFLOW PROFILE:

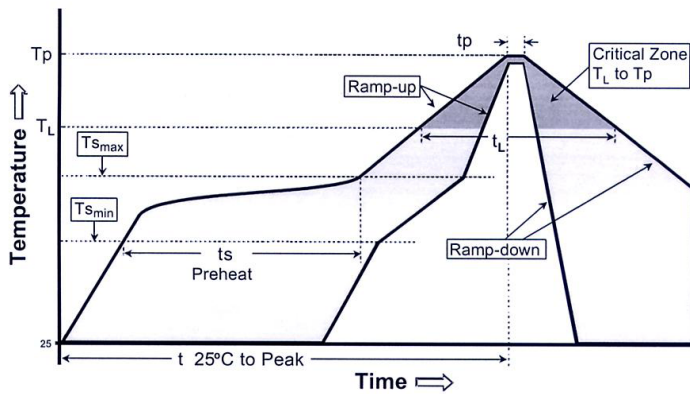

Profile Feature	Lead-Free Assembly
Average Ramp-Up Rate (T <sub>Smax</sub> to T <sub>p</sub> )	3°C/second max.
Preheat - Temperature Min (T <sub>Smin</sub> ) - Temperature Max (T <sub>Smax</sub> ) - Time (t <sub>Smin</sub> to t <sub>Smax</sub> )	150 °C 200 °C 60-180 seconds
Time maintained above: - Temperature (T <sub>L</sub> ) - Time (t <sub>L</sub> )	217 °C 60-150 seconds
Peak/Classification Temperature (T <sub>p</sub> ) Peak/Classification Time (t <sub>p</sub> )	260 °C 3-4 seconds
Time within 5 °C of actual Peak Temperature (t <sub>p</sub> )	20-40 seconds
Ramp-Down Rate	6°C/second max.
Time 25 °C to Peak Temperature	8 minutes max.

## TAPE & REEL:

### Packing

T= tape and reel (4,000 pcs/reel)

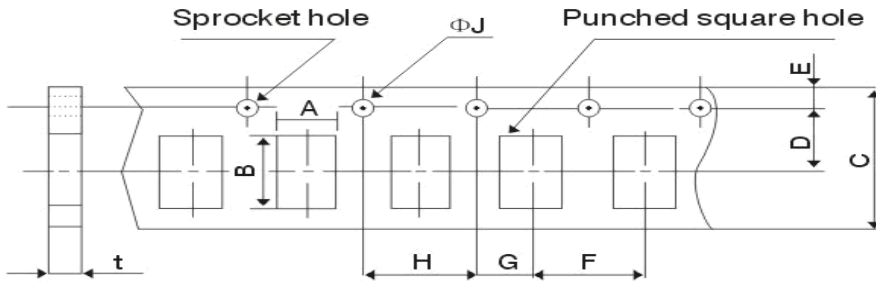

A	1.05±0.15
B	1.9±0.15
C	8.0±0.3
D	3.5±0.05
E	1.75±0.1
F	4.0±0.1
G	2.0±0.05
H	4.0±0.1
ΦJ	1.5+0.1/-0
t(max)	1.0±0.05

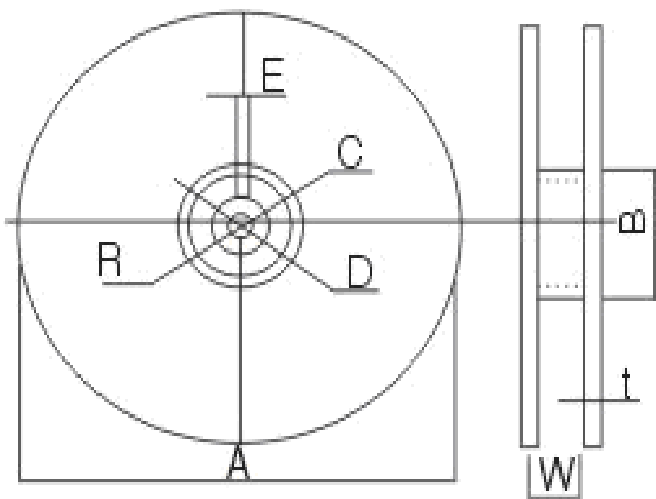

A	178±2
B	60±2
C	13.0±0.5
D	21.0±0.8
E	2.0±0.5
W	10.0±1.15
t	1.2±0.2
R	1.0±0.25

Dimension: mm

**ATTENTION:** Abracon Corporation's products are COTS – Commercial-Off-The-Shelf products; suitable for Commercial, Industrial and, where designated, Automotive Applications. Abracon's products are not specifically designed for Military, Aviation, Aerospace, Life-dependant Medical applications or any application requiring high reliability where component failure could result in loss of life and/or property. For applications requiring high reliability and/or presenting an extreme operating environment, written consent and authorization from Abracon Corporation is required. Please contact Abracon Corporation for more information.

ABRACON IS  
ISO 9001:2008  
CERTIFIED



Visit [www.abracon.com](http://www.abracon.com) for Terms & Conditions of Sale **Revised: 01.19.14**  
30332 Esperanza, Rancho Santa Margarita, California 92688  
tel 949-546-8000 | fax 949-546-8001 | [www.abracon.com](http://www.abracon.com)

## Данный компонент на территории Российской Федерации

### Вы можете приобрести в компании MosChip.

Для оперативного оформления запроса Вам необходимо перейти по данной ссылке:

<http://moschip.ru/get-element>

Вы можете разместить у нас заказ для любого Вашего проекта, будь то серийное производство или разработка единичного прибора.

В нашем ассортименте представлены ведущие мировые производители активных и пассивных электронных компонентов.

Нашей специализацией является поставка электронной компонентной базы двойного назначения, продукции таких производителей как XILINX, Intel (ex.ALTERA), Vicor, Microchip, Texas Instruments, Analog Devices, Mini-Circuits, Amphenol, Glenair.

Сотрудничество с глобальными дистрибьюторами электронных компонентов, предоставляет возможность заказывать и получать с международных складов практически любой перечень компонентов в оптимальные для Вас сроки.

На всех этапах разработки и производства наши партнеры могут получить квалифицированную поддержку опытных инженеров.

Система менеджмента качества компании отвечает требованиям в соответствии с ГОСТ Р ИСО 9001, ГОСТ РВ 0015-002 и ЭС РД 009

### Офис по работе с юридическими лицами:

105318, г.Москва, ул.Щербаковская д.3, офис 1107, 1118, ДЦ «Щербаковский»

Телефон: +7 495 668-12-70 (многоканальный)

Факс: +7 495 668-12-70 (доб.304)

E-mail: [info@moschip.ru](mailto:info@moschip.ru)

Skype отдела продаж:

moschip.ru

moschip.ru\_4

moschip.ru\_6

moschip.ru\_9