

Features

- 75 Ohm
- SMT unit
- RoHS Compliant and Pb free

Description

MAFL-011056 is a Low Cost, surface mount Diplex Filter unit designed for CATV applications, DTV and DBS applications.

Functional Schematic

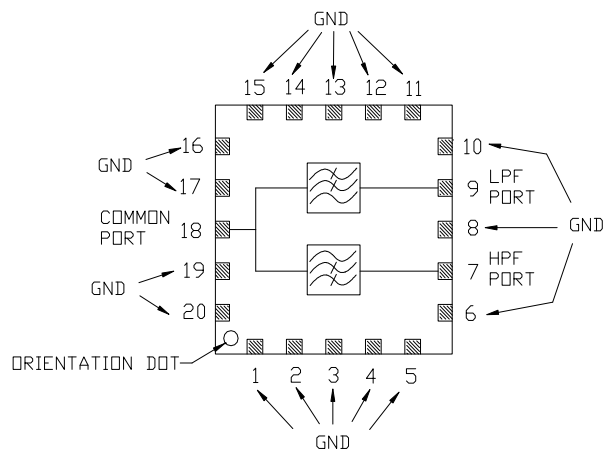

Ordering Information

Part Number	Package
MAFL-011056	200

Pin Configuration

Function	Pin Number
Common Port	18
Low Pass Port	9
High Pass Port	7
Ground	1 - 6, 8, 10-17, 19, 20
Not connected	-

Electrical Specifications: $T_A = 25^\circ\text{C}$, $Z_0 = 75\Omega$

Parameter	Units	Min	Typ	Max
Insertion Loss 5 - 65 MHz	dB	-	0.5	1.3
	dB		0.5	1.3
Insertion Loss Flatness 5 - 65 MHz	dB	-	-	0.5
Filter Rejection 5 - 65 MHz	dB	43	50	-
	dB	43	50	-
Filter Return Loss (all ports) 5 - 65 MHz	dB	18	20	-
	dB	17	20	-
Group Delay 61.5 - 65 MHz	nSec	-	-	20
	nSec	-	-	20

Recommended Maximum Ratings

Parameter	Value
Storage Temperature	-40°C to +85°C
Operating Temperature	-40°C to +85°C
DC Current	30mA
RF Power	250mW

Outline Drawing

TOP VIEW

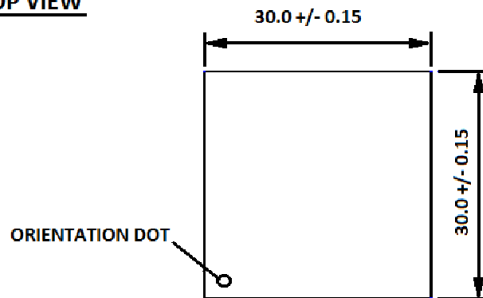

SIDE VIEW

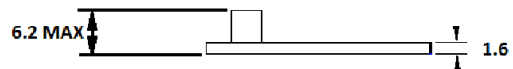

PCB TOP VIEW

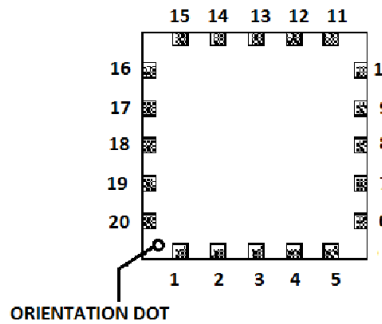

PCB BOTTOM VIEW

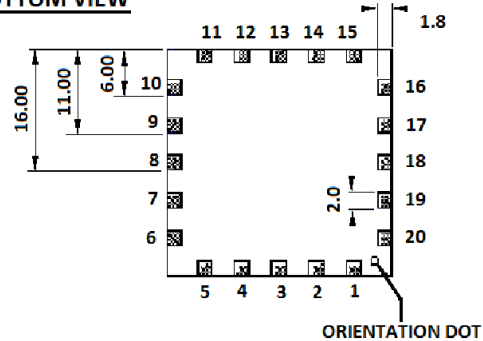

Dimensions in mm. Tolerance: .x ± 0.1, .xx ± 0.05

Recommended PCB Configuration

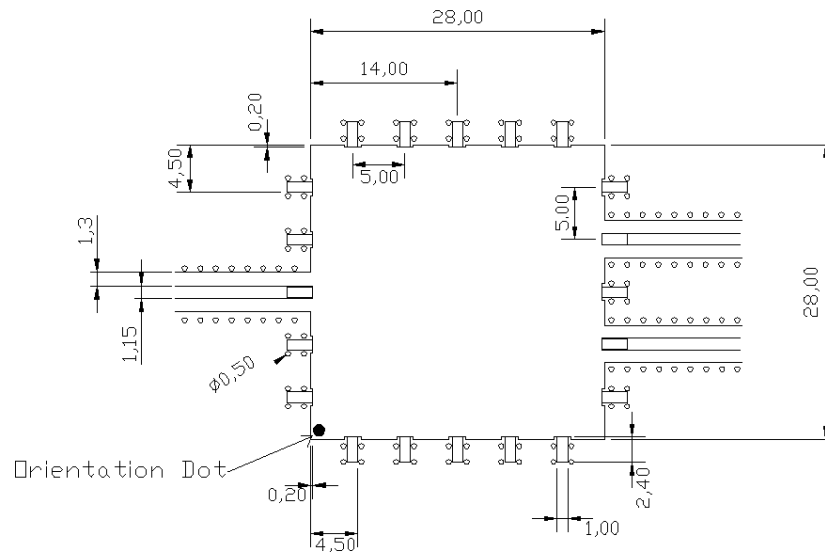

Dimensions in mm. Tolerance: .x ± 0.1, .xx ± 0.05

CATV Duplex Filter 5-65 / 88-1218MHz

Rev. V1

Typical Performance: $T_A = 25^\circ\text{C}$, $Z_0 = 75\Omega$

Input Port Return Loss

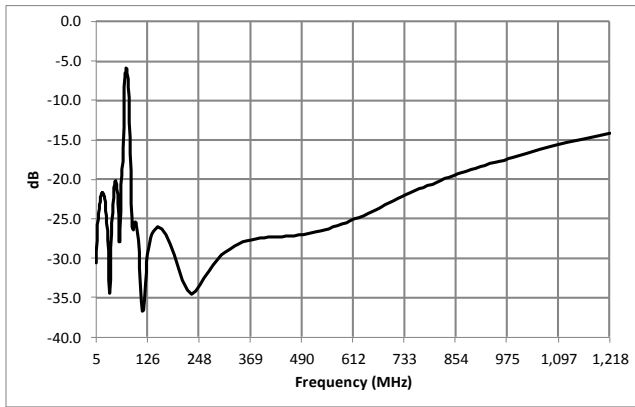

Low Pass Filter Insertion Loss

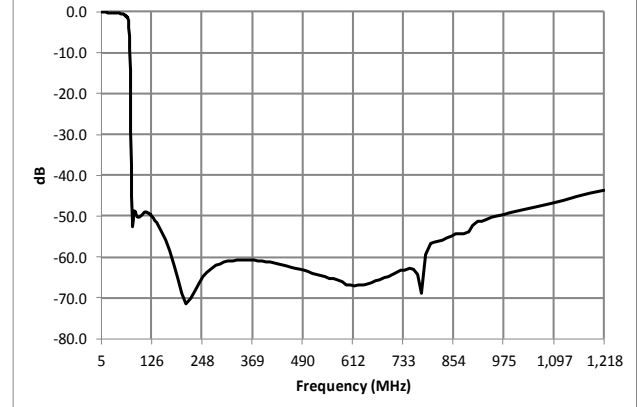

High Pass Filter Insertion Loss

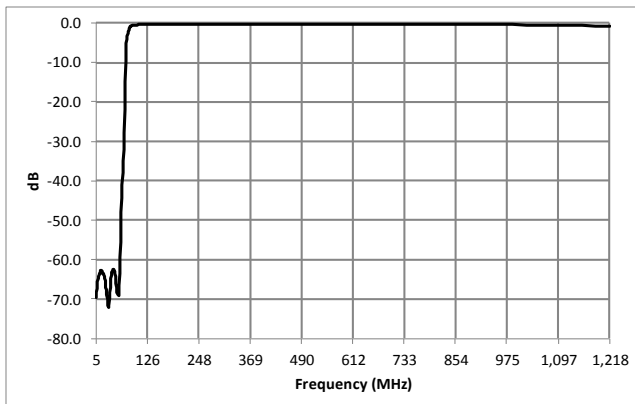

Filter Isolation

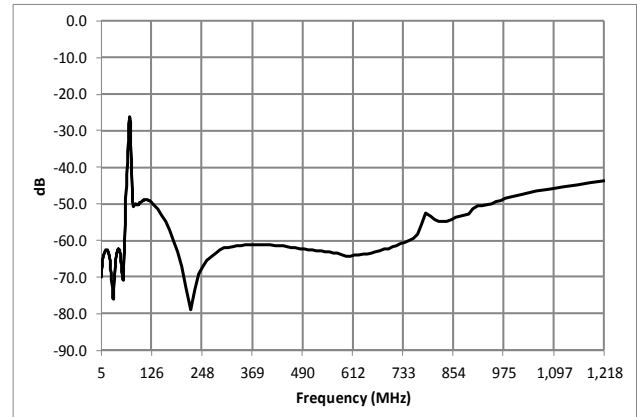

Low Pass port Return Loss

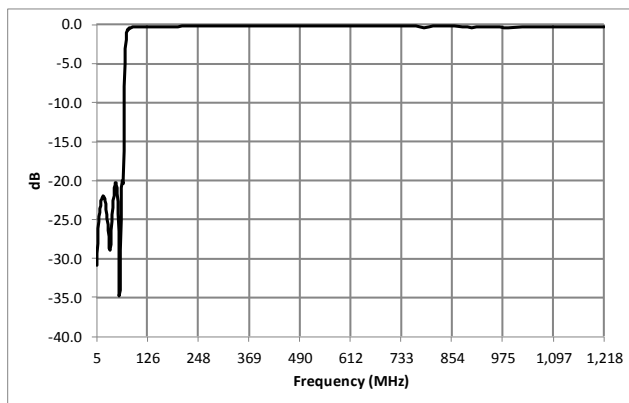

High Pass port Return Loss

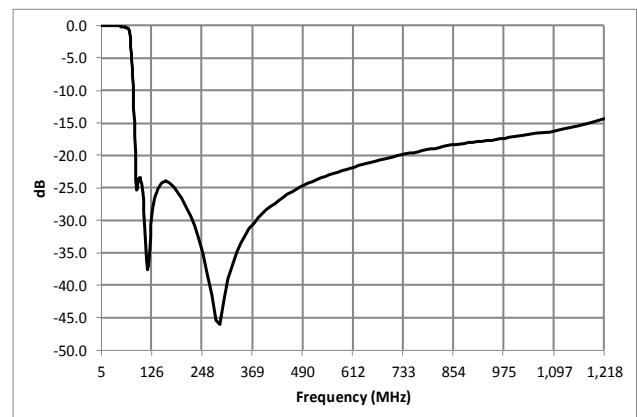

Tape & Reel Information

Parameter	Units	Value
Qty per reel	-	200
Reel Size	mm	330
Tape Width	mm	56.00
Pitch	mm	40.00
Ao	mm	30.3
Bo	mm	30.3
Ko	mm	6.4
Orientation	-	F30
Reference Application Note ANI-019 for orientation		

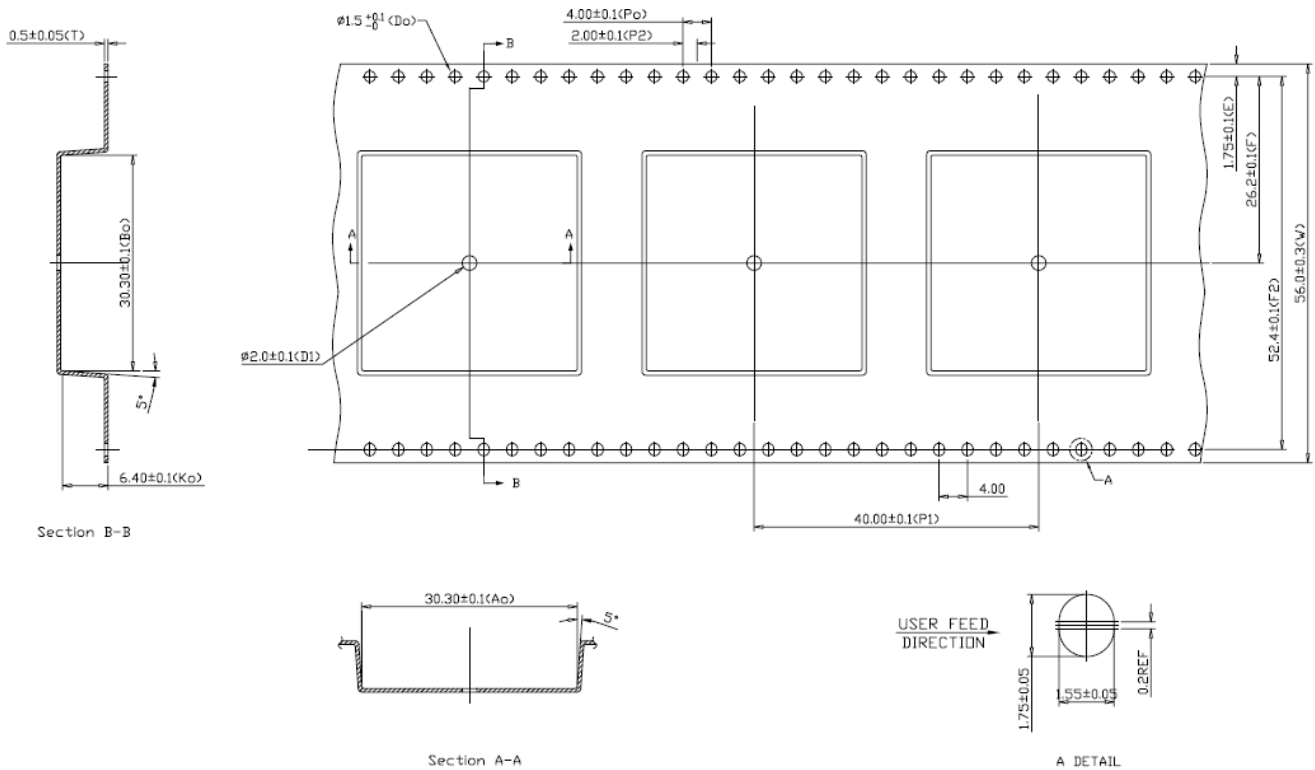

M/A-COM Technology Solutions Inc. All rights reserved.

Information in this document is provided in connection with M/A-COM Technology Solutions Inc ("MACOM") products. These materials are provided by MACOM as a service to its customers and may be used for informational purposes only. Except as provided in MACOM's Terms and Conditions of Sale for such products or in any separate agreement related to this document, MACOM assumes no liability whatsoever. MACOM assumes no responsibility for errors or omissions in these materials. MACOM may make changes to specifications and product descriptions at any time, without notice. MACOM makes no commitment to update the information and shall have no responsibility whatsoever for conflicts or incompatibilities arising from future changes to its specifications and product descriptions. No license, express or implied, by estoppel or otherwise, to any intellectual property rights is granted by this document.

THESE MATERIALS ARE PROVIDED "AS IS" WITHOUT WARRANTY OF ANY KIND, EITHER EXPRESS OR IMPLIED, RELATING TO SALE AND/OR USE OF MACOM PRODUCTS INCLUDING LIABILITY OR WARRANTIES RELATING TO FITNESS FOR A PARTICULAR PURPOSE, CONSEQUENTIAL OR INCIDENTAL DAMAGES, MERCHANTABILITY, OR INFRINGEMENT OF ANY PATENT, COPYRIGHT OR OTHER INTELLECTUAL PROPERTY RIGHT. MACOM FURTHER DOES NOT WARRANT THE ACCURACY OR COMPLETENESS OF THE INFORMATION, TEXT, GRAPHICS OR OTHER ITEMS CONTAINED WITHIN THESE MATERIALS. MACOM SHALL NOT BE LIABLE FOR ANY SPECIAL, INDIRECT, INCIDENTAL, OR CONSEQUENTIAL DAMAGES, INCLUDING WITHOUT LIMITATION, LOST REVENUES OR LOST PROFITS, WHICH MAY RESULT FROM THE USE OF THESE MATERIALS.

MACOM products are not intended for use in medical, lifesaving or life sustaining applications. MACOM customers using or selling MACOM products for use in such applications do so at their own risk and agree to fully indemnify MACOM for any damages resulting from such improper use or sale.

Данный компонент на территории Российской Федерации

Вы можете приобрести в компании MosChip.

Для оперативного оформления запроса Вам необходимо перейти по данной ссылке:

<http://moschip.ru/get-element>

Вы можете разместить у нас заказ для любого Вашего проекта, будь то серийное производство или разработка единичного прибора.

В нашем ассортименте представлены ведущие мировые производители активных и пассивных электронных компонентов.

Нашей специализацией является поставка электронной компонентной базы двойного назначения, продукции таких производителей как XILINX, Intel (ex.ALTERA), Vicor, Microchip, Texas Instruments, Analog Devices, Mini-Circuits, Amphenol, Glenair.

Сотрудничество с глобальными дистрибьюторами электронных компонентов, предоставляет возможность заказывать и получать с международных складов практически любой перечень компонентов в оптимальные для Вас сроки.

На всех этапах разработки и производства наши партнеры могут получить квалифицированную поддержку опытных инженеров.

Система менеджмента качества компании отвечает требованиям в соответствии с ГОСТ Р ИСО 9001, ГОСТ РВ 0015-002 и ЭС РД 009

Офис по работе с юридическими лицами:

105318, г.Москва, ул.Щербаковская д.3, офис 1107, 1118, ДЦ «Щербаковский»

Телефон: +7 495 668-12-70 (многоканальный)

Факс: +7 495 668-12-70 (доб.304)

E-mail: info@moschip.ru

Skype отдела продаж:

moschip.ru

moschip.ru_4

moschip.ru_6

moschip.ru_9