

Dynamic NFC/RFID tag IC with 4-Kbit EEPROM, NFC Forum Type 4 Tag and I²C interface

Datasheet - production data

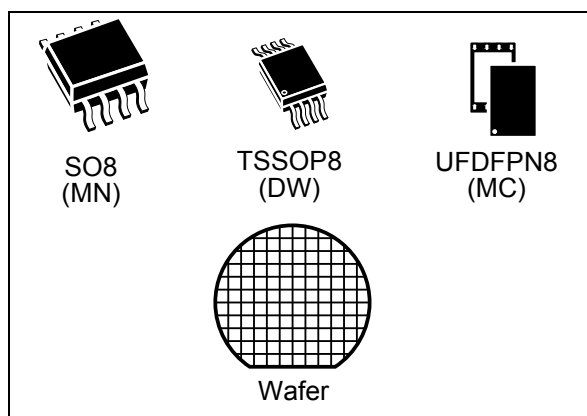

- 7 bytes unique identifier (UID)
- 128 bits passwords protection

Package

- 8-lead small-outline package (SO8) ECOPACK2[®]
- TSSOP8 ECOPACK2[®]
- UFDFPN8 ECOPACK2[®]

Digital pad

- GPO: configurable General Purpose Output
- RF disable: activation/deactivation of RF commands

Temperature range

- From - 40 °C up to 85 °C

Description

M24SR04 belongs to the ST25 family which includes all STMicroelectronics NFC/RFID tag and reader products.

The M24SR04 devices is a dynamic NFC/RFID tag IC with a dual interface. It embeds an EEPROM memory. It can be operated from an I²C interface or by a 13.56 MHz RFID reader or an NFC phone.

The I²C interface uses a two-wire serial interface, consisting of a bidirectional data line and a clock line. It behaves as a slave in the I²C protocol.

The RF protocol is compatible with ISO/IEC 14443 Type A and NFC Forum Type 4 Tag.

Features

I²C interface

- Two-wire I²C serial interface supports 1 MHz protocol
- Single supply voltage:
 - 2.7 V to 5.5 V for grade Y
 - 2.4 V to 5.5 V for grade G (Limited temperature range -25 to 85 °C)

Contactless interface

- NFC Forum Type 4 Tag
- ISO/IEC 14443 Type A
- 106 Kbps data rate
- Internal tuning capacitance: 25 pF

Memory

- 512-byte (4-kbit) EEPROM
- Support of NDEF data structure
- Data retention: 200 years
- Write cycle endurance:
 - 1 million Write cycles at 25 °C
 - 600k Write cycles at 85 °C
- Read up to 246 bytes in a single command
- Write up to 246 bytes in a single command

Contents

1	Functional description	9
1.1	Functional modes	10
1.1.1	I2C mode	10
1.1.2	Tag mode	10
1.1.3	Dual interface mode	11
2	Signal descriptions	12
2.1	Serial clock (SCL)	12
2.2	Serial data (SDA)	12
2.3	Antenna coil (AC0, AC1)	12
2.4	Ground (VSS)	12
2.5	Supply voltage (V_{CC})	12
2.5.1	Operating supply voltage V_{CC}	12
2.5.2	Power-up conditions	13
2.5.3	Device reset in I ² C mode	13
2.5.4	Power-down conditions	13
2.6	RF disable	13
2.7	General purpose output (GPO)	13
2.7.1	Session Open configuration (GPO field = 0xX1 or 0x1X)	14
2.7.2	WIP Writing in Progress configuration (GPO field = 0xX2 or 0x2X)	15
2.7.3	I ² C answer ready configuration (GPO field = 0xX3)	16
2.7.4	MIP NDEF Message writing in Progress configuration (GPO field = 0x3X)	17
2.7.5	INT Interrupt configuration (GPO field = 0xX4 or 0x4X)	18
2.7.6	State Control configuration (GPO field = 0xX5 or 0x5X)	19
2.7.7	RF busy configuration (GPO field = 0x6X)	20
3	M24SR04 memory management	21
3.1	Memory structure	21
3.1.1	File identifier	21
3.1.2	CC file layout	21
3.1.3	NDEF file layout	22
3.1.4	System file layout	23
3.2	Read and write access rights to the memory	25

3.2.1	State of the Read and Write access rights	25
3.2.2	Changing the read access right to NDEF files	26
3.2.3	Changing the write access right to NDEF files	27
3.3	Access right life time	27
3.4	NDEF file passwords	27
3.5	I2C password	28
3.5.1	I ² C password and I ² C protect field of the System file	28
4	Communication mechanism	29
4.1	Master and slave	29
4.2	M24SR04 session mechanism	29
4.2.1	RF token	29
4.2.2	I ² C token	29
5	I²C and RF command sets	30
5.1	Structure of the command sets	31
5.2	I-Block format	31
5.2.1	C-APDU: payload format of a command	32
5.2.2	R-APDU: payload format of a response	33
5.3	R-Block format	33
5.4	S-Block format	34
5.5	CRC of the I2C and RF frame	35
5.6	NFC Forum Type 4 Tag protocol	36
5.6.1	Commands set	36
5.6.2	Status and error codes	36
5.6.3	NDEF Tag Application Select command	38
5.6.4	Capability Container Select command	38
5.6.5	NDEF Select command	39
5.6.6	System File Select command	40
5.6.7	ReadBinary command	41
5.6.8	UpdateBinary command	42
5.7	ISO/IEC 7816-4 commands	43
5.7.1	Verify command	43
5.7.2	Change Reference Data command	44
5.7.3	Enable Verification Requirement command	45
5.7.4	Disable Verification Requirement command	46

5.8	ST Proprietary command set	47
5.8.1	ExtendedReadBinary command	47
5.8.2	EnablePermanentState command	48
5.8.3	DisablePermanentState command	49
5.8.4	UpdateFileType command	50
5.8.5	SendInterrupt command	51
5.8.6	StateControl command	51
5.9	Specific RF command set	52
5.9.1	Anticollision command set	52
5.9.2	RATS command and ATS response	52
5.9.3	PPS command & response	54
5.10	Specific I ² C command set	55
5.10.1	GetI2Csession command	55
5.10.2	KillRFsession command	55
6	RF device operation	56
6.1	Anticollision and Device Activation command set for the RF interface	56
6.2	Open an RFsession	56
6.3	Close an RFsession	56
6.4	Applicative command set	56
7	I²C device operation	57
7.1	I ² C communication protocol	57
7.2	Start condition	58
7.3	Stop condition	58
7.4	I ² C token release sequence	58
7.5	I ² C timeout on clock period	59
7.6	Acknowledge bit (ACK)	59
7.7	Data input	59
7.8	I ² C device address	59
7.9	I ² C frame format	60
7.9.1	Example of I ² C frame commands	60
7.10	Open an I ² C session	62
7.11	Close the I ² C session	62

8	Functional procedures	63
8.1	Selection of an NDEF message	63
8.2	Reading of an NDEF message	63
8.3	Reading a locked NDEF file	63
8.4	Locking an NDEF file	64
8.5	Unlocking an NDEF file	64
8.6	Reaching the read-only state for an NDEF file	64
8.7	Changing an NDEF password procedure	64
8.8	Changing a File type Procedure	65
8.9	Updating a NDEF file	65
9	UID: Unique identifier	66
10	Maximum ratings	67
11	I2C DC and AC parameters	68
11.1	I2C timing measurement condition	73
12	GPO parameters	75
13	Write cycle definition	77
14	RF electrical parameters	78
15	Package information	79
15.1	SO8N package information	79
15.2	TSSOP8 package information	81
15.3	UFDFPN8 package information	82
16	Ordering information	84
17	Revision history	85

List of tables

Table 1.	Signal names	10
Table 2.	Functional mode	10
Table 3.	File identifier	21
Table 4.	CC file layout for 1 NDEF file	22
Table 5.	NDEF file layout	23
Table 6.	Field list.	23
Table 7.	Details about I2C watchdog	23
Table 8.	Details about the GPO field	24
Table 9.	Details about the RF Session field	24
Table 10.	Details about the ST reserved field.	25
Table 11.	Details about the RF enable field	25
Table 12.	Read access right	26
Table 13.	Write access right	26
Table 14.	RF and I ² C command sets	30
Table 15.	I-Block format	31
Table 16.	PCB field of the I-Block format	32
Table 17.	C-APDU format	32
Table 18.	R-APDU format	33
Table 19.	R-Block format	33
Table 20.	R-Block detailed format	34
Table 21.	S-Block format	34
Table 22.	S-Block detailed format.	35
Table 23.	Command set overview	36
Table 24.	Status code of the M24SR04	36
Table 25.	Error code of the M24SR04	36
Table 26.	C-APDU of the NDEF Tag Application Select command	38
Table 27.	R-APDU of the NDEF Tag Application Select command	38
Table 28.	C-APDU of the Capability Container Select command	39
Table 29.	R-APDU of the Capability Container Select command	39
Table 30.	C-APDU of the NDEF Select command	39
Table 31.	R-APDU of the NDEF Select command	40
Table 32.	C-APDU of the System File Select command.	40
Table 33.	R-APDU of the System File Select command.	40
Table 34.	C-APDU of the ReadBinary command	41
Table 35.	R-APDU of the ReadBinary command	41
Table 36.	C-APDU of the UpdateBinary command	42
Table 37.	R-APDU of the UpdateBinary command	42
Table 38.	Verify command format.	43
Table 39.	R-APDU of the Verify command	44
Table 40.	Change reference data command format	44
Table 41.	R-APDU of the Change Reference Data command	45
Table 42.	Enable Verification Requirement command format	45
Table 43.	R-APDU of the Enable Verification Requirement command.	46
Table 44.	Disable Verification Requirement command format	46
Table 45.	R-APDU of the Disable Verification Requirement command	47
Table 46.	C-APDU of the ExtendedReadBinary command	47
Table 47.	R-APDU of the ExtendedReadBinary command	48
Table 48.	EnablePermanentState command format.	48

Table 49.	R-APDU table of the EnablePermanentState command	48
Table 50.	DisablePermanentState command format	49
Table 51.	R-APDU of the DisablePermanentState command	49
Table 52.	UpdateFileType command format	50
Table 53.	R-APDU of the UpdateFileType command	50
Table 54.	SendInterrupt command format	51
Table 55.	R-APDU of the SendInterrupt command	51
Table 56.	StateControl command format	52
Table 57.	R-APDU of the StateControl command	52
Table 58.	Commands issues by the RF host	52
Table 59.	RATS command	53
Table 60.	Conversion from FDSI to FSD	53
Table 61.	ATS response	53
Table 62.	PPS command	54
Table 63.	Ascending and descending data rate coding	54
Table 64.	PPS response	54
Table 65.	Specific I ² C commands	55
Table 66.	GetI2Csession command format	55
Table 67.	KillRFsession command format	55
Table 68.	I ² C device address format	59
Table 69.	I ² C frame format	60
Table 70.	I ² C host to M24SR04	60
Table 71.	M24SR04 to I ² C host	61
Table 72.	UID format	66
Table 73.	Absolute maximum ratings	67
Table 74.	I ² C operating conditions	68
Table 75.	AC test measurement conditions	68
Table 76.	Input parameters	68
Table 77.	I ² C DC characteristics	69
Table 78.	I ² C AC characteristics (400 kHz)	70
Table 79.	I ² C AC characteristics (1 MHz)	71
Table 80.	Device select code	74
Table 81.	GPO timings measurement	75
Table 82.	Write cycle definition	77
Table 83.	Default operating conditions	78
Table 84.	RF characteristics	78
Table 85.	SO8N - 8-lead plastic small outline, 150 mils body width, package data	79
Table 86.	TSSOP8 – 8-lead thin shrink small outline, 3 x 6.4 mm, 0.65 mm pitch, package mechanical data	81
Table 87.	UFDFPN8 - 8- lead, 2 x 3 mm, 0.5 mm pitch ultra thin profile fine pitch dual flat package mechanical data	83
Table 88.	Ordering information scheme for packaged devices	84
Table 89.	Document revision history	85

List of figures

Figure 1.	M24SR04 block diagram	9
Figure 2.	8-pin package connections	10
Figure 3.	GPO configured as Session Open (GPO field = 0xX1 or 0x1X)	14
Figure 4.	GPO configured as WIP (GPO field = 0xX2 or 0x2X)	15
Figure 5.	GPO configured as I ² C answer ready (GPO field = 0xX3)	16
Figure 6.	GPO configured as MIP (GPO field = 0xX3)	17
Figure 7.	GPO configured as INT (GPO field = 0xX4 or 0x4X)	18
Figure 8.	GPO configured as State Control (GPO field = 0xX5 or 0x5X)	19
Figure 9.	GPO configured as RF busy (GPO field = 0xX6)	20
Figure 10.	Changing the read access right to an NDEF file	26
Figure 11.	Changing the write access right to an NDEF file	27
Figure 12.	Command and response exchange	57
Figure 13.	I ² C token release sequence	58
Figure 14.	NDEF tag Application Select command	61
Figure 15.	AC test measurement I/O waveform	68
Figure 16.	I ² C AC waveforms	72
Figure 17.	Maximum Rbus value with f _C = 400 kHz	73
Figure 18.	Maximum Rbus value with f _C = 1 MHz	73
Figure 19.	I2C bus protocol	74
Figure 20.	SO8N - 8-lead plastic small outline, 150 mils body width, package outline	79
Figure 21.	SO8N - 8-lead plastic small outline, 150 mils body width, package recommended footprint	80
Figure 22.	TSSOP8 – 8-lead thin shrink small outline, 3 x 6.4 mm, 0.65 mm pitch, package outline	81
Figure 23.	UFDFPN8 - 8-lead, 2 x 3 mm, 0.5 mm pitch ultra thin profile fine pitch dual flat package outline	82

1 Functional description

The M24SR04 device is a dynamic NFC/RFID tag that can be accessed either from the I²C or the RF interface. The RF and I²C host can read or write to the same memory, that is why only one host can communicate at a time with the M24SR04. The management of the interface selection is controlled by the M24SR04 device itself.

The RF interface is based on the ISO/IEC 14443 Type A standard. The M24SR04 is compatible with the NFC Forum Type 4 Tag specifications and supports all corresponding commands.

The I²C interface uses a two-wire serial interface consisting of a bidirectional data line and a clock line. The devices carry a built-in 4-bit device type identifier code in accordance with the I²C bus definition.

The device behaves as a slave in the I²C protocol.

Figure 1 displays the block diagram of the M24SR04 device.

Figure 1. M24SR04 block diagram

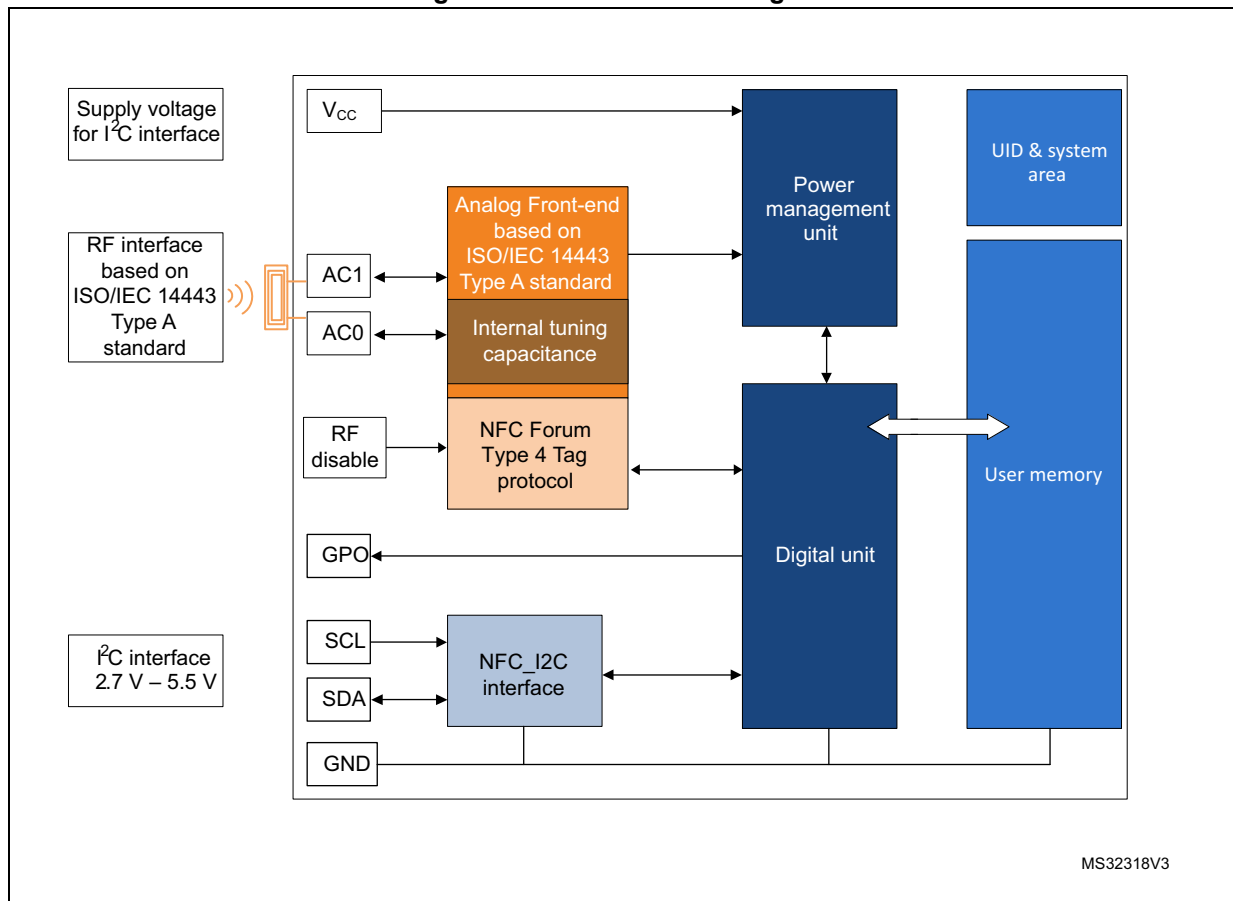

Table 1. Signal names

Signal name	Function	Direction
SDA	Serial data	I/O
SCL	Serial clock	Input
AC0, AC1	Antenna coils	-
V _{CC}	Supply voltage	-
V _{SS}	Ground	-
GPO	Interrupt output ⁽¹⁾	Open drain output
RF disable	Disable the RF communication ⁽²⁾	Input

1. An external pull-up > 4.7 kΩ is required.
2. An external pull-down is required when the voltage on V_{CC} is above its POR level.

Figure 2. 8-pin package connections



1. See Package mechanical data section for package dimensions, and how to identify pin 1.

1.1 Functional modes

The M24SR04 has two functional modes available. The difference between the modes lies in the power supply source (see [Table 2](#)).

Table 2. Functional mode

Mode	Supply source	Comments
I ² C mode	V _{CC}	The I ² C interface is available
Tag mode	RF field only	The I ² C interface is disconnected
Dual interface mode	RF field or V _{CC}	Both I ² C and RF interfaces are available

1.1.1 I²C mode

M24SR04 is powered by V_{CC}. The I²C interface is connected to the M24SR04. The I²C host can communicate with the M24SR04 device.

1.1.2 Tag mode

The M24SR04 is supplied by the RF field and can communicate with an RF host (RFID reader or an NFC phone). The User memory can only be accessed by the RF commands.

1.1.3 Dual interface mode

Both interfaces, RF and I²C, are connected to the M24SR04 and both RF or I²C host can communicate with the M24SR04 device. The power supply and the access management are carried out by the M24SR04 itself. For further details, please refer to the token mechanism chapter.

2 Signal descriptions

2.1 Serial clock (SCL)

This input signal is used to strobe all data in and out of the device. In applications where this signal is used by slave devices to synchronize the bus to a slower clock, the bus master must have an open drain output, and a pull-up resistor must be connected from Serial clock (SCL) to V_{CC} . (Figure 17 indicates how the value of the pull-up resistor can be calculated).

In most applications, though, this method of synchronization is not employed, and so the pull-up resistor is not necessary, provided that the bus master has a push-pull (rather than open drain) output.

2.2 Serial data (SDA)

This bidirectional signal is used to transfer data in or out of the device. It is an open drain output that may be wire-OR'ed with other open drain or open collector signals on the bus. A pull-up resistor must be connected from Serial data (SDA) to V_{CC} . (Figure 17 indicates how the value of the pull-up resistor can be calculated).

2.3 Antenna coil (AC0, AC1)

These inputs are used to connect the device to an external coil exclusively. It is advised not to connect any other DC or AC path to AC0 or AC1.

When correctly tuned, the coil is used to access the device using NFC Forum Type 4 commands.

2.4 Ground (V_{SS})

V_{SS} , when connected, is the reference for the V_{CC} supply voltage for all pads, even AC0 and AC1.

2.5 Supply voltage (V_{CC})

This pin can be connected to an external DC supply voltage.

Note: An internal voltage regulator allows the external voltage applied on V_{CC} to supply the M24SR04.

2.5.1 Operating supply voltage V_{CC}

Prior to selecting the M24SR04 and issuing instructions to it, a valid and stable V_{CC} voltage within the specified [$V_{CC}(\min)$, $V_{CC}(\max)$] range must be applied. To maintain a stable DC supply voltage, it is recommended to decouple the V_{CC} line with suitable capacitors (usually of the order of 10 nF and 100 pF) close to the V_{CC}/V_{SS} package pins.

This voltage must remain stable and valid until the end of the transmission of the instruction and, for a writing instruction (UpdateBinary, ChangeReferenceData,

EnableVerificationRequirement, DisableVerificationRequirement, EnablePermanentState, DisablePermanentState, until the completion of the internal I²C write cycle (t_W).

2.5.2 Power-up conditions

When the power supply is turned on, V_{CC} rises from V_{SS} to V_{CC} . The V_{CC} rise time must not vary faster than $1V/\mu s$.

2.5.3 Device reset in I²C mode

In order to prevent inadvertent write operations during power-up, a power-on reset (POR) circuit is included. At power-up (continuous rise of V_{CC}), the M24SR04 does not respond to any I²C instruction until V_{CC} has reached the power-on reset threshold voltage (this threshold is lower than the minimum V_{CC} operating voltage defined). When V_{CC} passes over the POR threshold, the device is reset and enters the Standby power mode. However, the device must not be accessed until V_{CC} has reached a valid and stable V_{CC} voltage within the specified [$V_{CC}(\min)$, $V_{CC}(\max)$] range.

In a similar way, during power-down (continuous decrease in V_{CC}), as soon as V_{CC} drops below the power-on reset threshold voltage, the M24SR04 stops responding to any instruction sent to it.

2.5.4 Power-down conditions

During power-down (continuous decay of V_{CC}), the M24SR04 must be in Standby power mode (mode reached after decoding a Stop condition, assuming that there is no internal operation in progress).

2.6 RF disable

This input signal is used to disable the RF communication. When the voltage on the V_{CC} pin is below the POR level or not connected, an internal pull-down resistor is connected on this pad. Thus, the RF disable pad is maintained to the low level and the RF analog front end is activated. When the voltage on the V_{CC} pin is higher than the POR level, the I²C host shall set this pin to enable or disable the RF communication. In Dual interface mode, RF disable must not be left floating.

2.7 General purpose output (GPO)

The GPO pad is an open drain pad and an external pull-up resistor shall be connected to it. This pad is a configurable output signal. On delivery, GPO is configured as Session opened. Its behavior is consistent with the I²C or RF session activated and with the mode chosen by the user. The GPO pad is enable when an RF or an I²C session is open. When neither an RF nor an I²C session is open, the GPO is high impedance.

The user can select one of these configurations⁽¹⁾:

- SessionOpen: an RF or I²C session is ongoing.
- MIP (NDEF Message updating In Progress): the RF host is writing an NDEF length different from 0x0000. This mode can be used to detect when the RF host changes the NDEF message as defined by the NFC Forum.
- WIP (Writing In Progress): the M24SR04 is executing a writing operation.
- INT (interrupt): the I²C or RF host can force the M24SR04 to send a negative pulse on the GPO pin.
- I²C ready response: an I²C response is ready to be read by the I²C host.
- State mode: the I²C or RF host can control the state of the GPO pad during the RF session.
- RF busy: an RF host is communicating with the M24SR04.

2.7.1 Session Open configuration (GPO field = 0xX1 or 0x1X)

When the GPO is configured as "Session Open", it goes to the Low state when an RF or I²C session is ongoing (see [Figure 3](#)).

An RF session is taken when M24SR04 receives a valid Select Application. The session is released after M24SR04 has received a valid Deselect command, if M24SR04 has received a Kill RF session command in I²C or when the RF field became OFF.

An I²C session is taken when M24SR04 receives a valid Get session command or a valid Kill RF session command. The session is released after M24SR04 has received I²C token release sequence or after a Power Off.

GPO is driven low after a delay (1) or (3) when the session is open.

GPO is released after a delay (2) or (4) when the session is released.

Figure 3. GPO configured as Session Open (GPO field = 0xX1 or 0x1X)

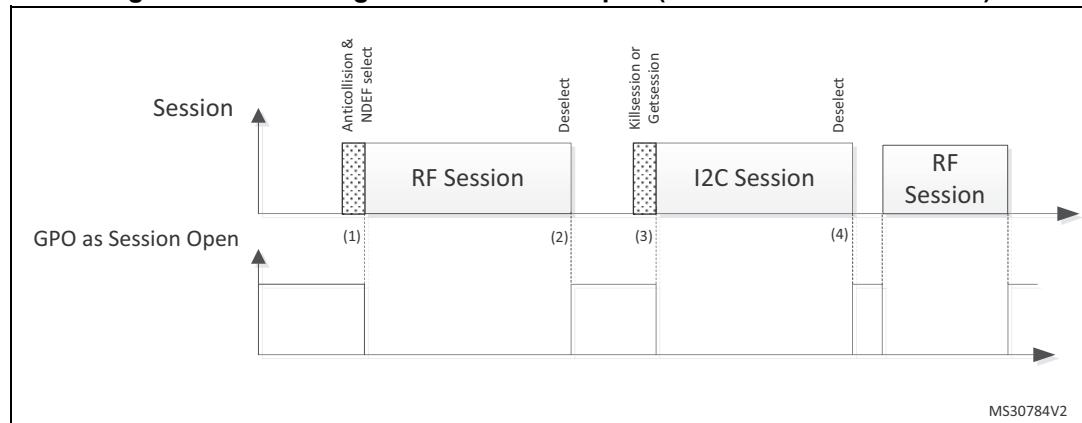

1. CmdEOFtoGPlow (RF command End of frame to GPORF Session pad low)
2. CmdEOFtoGPHZ (RF command End of frame to GPORF Session pad HZ)
3. CmdSTPtoGPlow (I2C command stop to GPO low)
4. AnswerlLBtoGPHZ (I2C answer last bit of last byte to GPO HZ)

1. See [Table 81](#) for more details.

2.7.2 WIP Writing in Progress configuration (GPO field = 0xX2 or 0x2X)

When the GPO is configured as "WIP", it goes to the Low state during an I²C or RF writing operation.

During an RF or I²C session, when M24SR04 updates a file, GPO is driven low after a delay (1) or (3) following the beginning of the correspondent UpdateBinary command execution.

GPO will remain low during the writing time (2) or (4), before being released.

Figure 4. GPO configured as WIP (GPO field = 0xX2 or 0x2X)

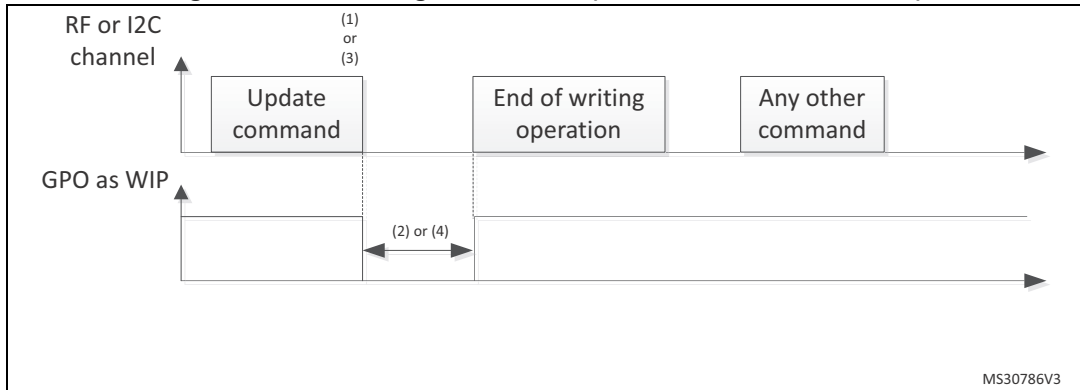

1. CmdSTPtoGPlow (I2C Command Stop to GPO low)
2. Writing time duration
3. CmdEOFtoGPlow (RF Command End of frame to GPO low)
4. Writing time duration

2.7.3 I²C answer ready configuration (GPO field = 0xX3)

When the GPO is configured as I²C answer ready, it goes to the Low state when the M24SR04 has finished to treat the I²C command and is ready to send the I²C response.

During an I²C session, after receiving a valid I²C command, GPO pin is driven low after a delay when M24SR04 is ready to deliver a response on the I²C bus.

GPO is released when M24SR04 receives a new command.

Figure 5. GPO configured as I²C answer ready (GPO field = 0xX3)



2.7.4 MIP NDEF Message writing in Progress configuration (GPO field = 0x3X)

When the GPO is configured as MIP, its state goes to the low state when the RF host writes the NDEF length to another value than 0x0000.

During an RF session, when M24SR04 changes an NDEF file and updates the NDEF length with a value different from 0x0000, GPO is driven low after a delay (1) following the beginning of the correspondent UpdateBinary command execution.

GPO will remain low during the writing time (2), before being released.

Figure 6. GPO configured as MIP (GPO field = 0x3X)



1. CmdEOFToGPlow (RF command End of frame to GPO low)
2. Writing time duration

2.7.5 INT Interrupt configuration (GPO field = 0xX4 or 0x4X)

The I²C or RF host can send a negative pulse on the GPO pad. The GPO pad goes to the low state at the end of the command and goes to the high state at the end of the M24SR04 response.

During an RF or I²C session, when M24SR04 receives a valid Interrupt command, M24SR04 GPO pin is driven low after (1) or (3) for a duration of (4) in RF, or after responding in I2C (2). Then GPO pin is released.

Figure 7. GPO configured as INT (GPO field = 0xX4 or 0x4X)



1. CmdSTPtoGPlow (I2C command Stop to GPO low)
2. After NewCmdIbFB (new I2C command last bit of first byte) or after AnswerIbFB (I2C answer last bit of first byte)
3. CmdEOFtoGPlow (RF command End of frame to GPO low)
4. GPO pulse duration

2.7.6 State Control configuration (GPO field = 0xX5 or 0x5X)

When the GPO is configured as State Control, the I²C or RF host can control the state of the GPO by sending a dedicated command.

During an RF or I²C session, the M24SR04 can control the GPO pin. After receiving a valid Set GPO command, GPO pin is driven low after a delay (1) or (3). GPO will be released after a valid Reset command or after a Power off or upon closing the RF session.

Figure 8. GPO configured as State Control (GPO field = 0xX5 or 0x5X)

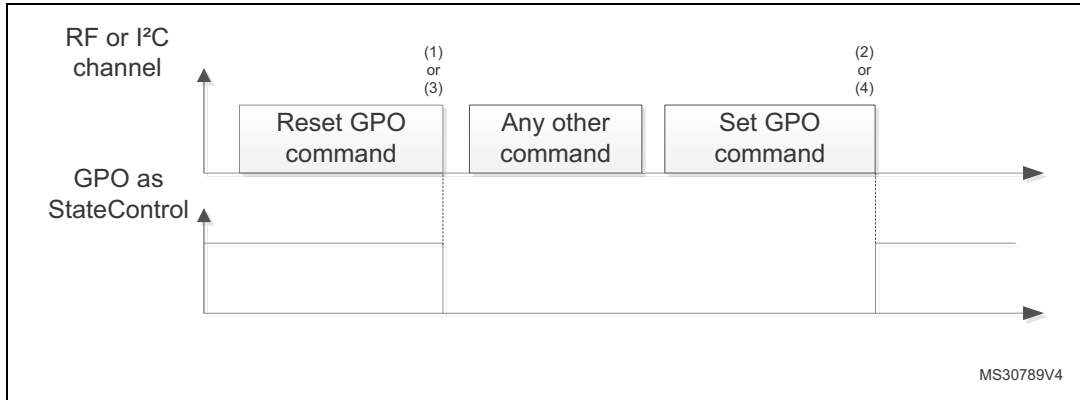

1. CmdSTPtoGPlow (I2C Set GPO command Stop to GPO low)
2. CmdSTPtoGPHZ (I2C Reset GPO command Stop to GPO HZ)
3. CmdEOFtoGPlow (RF Set GPO command End of frame to GPO low)
4. CmdEOFtoGPHZ (RF Reset GPO command End of frame to GPO HZ)

2.7.7 RF busy configuration (GPO field = 0x6X)

When the GPO is configured as RF busy, the GPO goes to the low state when the M24SR04 is processing an RF command or when an RF session is ongoing.

When an RF field is present, GPO is driven low after a delay (1) when M24SR04 detects the first command. If the RF session is ongoing and M24SR04 receives a not-supported command, GPO remains low. It will be released only at the end of the RF session, after (2).

Figure 9. GPO configured as RF busy (GPO field = 0x6X)



1. CmdSOFtoGPIow (RF command Start of frame to GPO low)
2. CmdEOFtoGPHZ (RF command End of frame to GPO HZ)

3 M24SR04 memory management

3.1 Memory structure

The M24SR04 supports the NDEF Tag Application as defined in the NFC Forum Type 4 Tag. The M24SR04 is composed of three files:

- One Capability Container file
- One NDEF file
- One System file: this is an ST-proprietary file

The System file contains some information on the configuration of the M24SR04 device. The CC file gives some information about the M24SR04 itself and the NDEF file. The NDEF file contains the User data.

3.1.1 File identifier

The file identifier is the value used in the Select command to select a file.

Table 3. File identifier

File identifier	Meaning
0xE101	System file
0xE103	CC file
0x0001	NDEF file

3.1.2 CC file layout

The CC file gives some information about the M24SR04 and the NDEF file. This file is a read-only file for the RF or I²C host and cannot be modified by issuing a write command.

The T field, Read Access and Write Access fields can be changed by the RF or I²C host by issuing a specific process (refer to [Section 8: Functional procedures](#)).

Table 4. CC file layout for 1 NDEF file

File offset	Meaning	Value	Comments
0x0000	Number of bytes of CC file	0x000F	15 bytes
0x0002	Mapping version ⁽¹⁾	0x20 or 0x10	V 2.0 or V 1.0
0x0003	Maximum number of bytes that can be read	0x00F6	246 bytes
0x0005	Maximum number of bytes that can be written	0x00F6	246 bytes
0x0007	NDEF file control TLV	0x04 ⁽²⁾	T field
0x0008		0x06	L field
0x0009		0x0001	FileID
0x000B		0x0200	Maximum NDEF file size
0x000D		0x00 ⁽²⁾	Read access
0x000E		0x00 ⁽²⁾	Write access

1. According to the reader.

2. Delivery state.

3.1.3 NDEF file layout

The NDEF file contains the NDEF message which contains the User data. The RF host or the I²C host can read and write data inside the file. The first two bytes named NDEF Message Length define the size of the NDEF message. The NDEF Message Length shall be managed by the application and the M24SR04 device does not check if its value is relevant vs the data written by the RF or I²C host. The M24SR04 device uses the NDEF Message Length, e. g. the standard read can be processed only inside the NDEF message; otherwise, the M24SR04 device returns an error code. For more details about the read command, refer to [Section 5.6.7: ReadBinary command](#).

Table 5. NDEF file layout

File offset	Byte 0	Byte 1	Byte 2	Byte 3
0x0000	NDEF message length		User data	User data
0x0004	User data	User data	User data	User data
...
...
...
0x01FC	User data

3.1.4 System file layout

The system file specifies the configuration of the M24SR04. [Table 6](#) lists the different fields.

Table 6. Field list

File offset	Field name	Number of bytes	Read access	Write access	Delivery state ⁽¹⁾
0x0000	Length system file	2	I ² C or RF	-	0x0012
0x0002	I ² C protect	1	I ² C or RF	I ² C ⁽²⁾	0x01
0x0003	I ² C watchdog	1	I ² C or RF	I ² C ⁽²⁾	0x00
0x0004	GPO	1	I ² C or RF	I ² C ⁽²⁾	0x11
0x0005	ST reserved	1	I ² C or RF	I ² C ⁽²⁾	0x00
0x0006	RF enable	1	I ² C or RF	I ² C ⁽²⁾	0x xxxx xxx1 ⁽³⁾
0x0007	NDEF File number (RFU)	1	I ² C or RF	none	0x00
0x0008	UID	7	I ² C or RF	none	0x0286 xx xx xx xx xx
0x000F	Memory Size	2	I ² C or RF	none	0x01FF
0x0011	Product Code	1	I ² C or RF	none	0x86 or 0x8E

1. The delivery state for all passwords = 0x00000000000000000000000000000000.
2. The access is granted when the field I²C protect is set to the state Unprotected or when the right I²C password was correctly received (see [Section 3.5: I2C password](#)).
3. Refer [Table 11](#).

Table 7. Details about I2C watchdog

File offset	b7- b0
0x0003	<p>The “I²C Watchdog” ensures the I²C host will not keep the session open, while there is no more activity on the I²C bus (between the stop bit of the previous transaction and the start bit of the next one)</p> <ul style="list-style-type: none"> – 0x00 (default value): the Watchdog is off – Other values: If programmed to a non null value N, the Watchdog is enabled and counts N*30 ms (30 ms is approximate) before releasing the I²C session.

Table 8. Details about the GPO field

File offset	b7	b6-b4	b3	b2-b0
0x0004				
RFU				
When an RF session is open:				
0b000: High impedance				
0b001: Session opened				
0b010: WIP				
0b011: MIP				
0b100: Interrupt				
0b101: State Control				
0b110: RF Busy				
0b111: RFU				
RFU				
When an I ² C session is open:				
0b000: High impedance				
0b001: Session opened				
0b010: WIP				
0b011: I ² C Answer Ready				
0b100: Interrupt				
0b101: State Control				
0b110: RFU				
0b111: RFU				

Table 9. Details about the RF Session field

File offset	b7	b6-b4	b3-b0
0x0004			
RFU			
When an RF session is open:			
0b001: Session opened			
RFU			

Table 10 gives some details about the ST reserved field.

Table 10. Details about the ST reserved field

File offset	b7-b0
0x0005	
0x00	

Table 11 gives some details about the RF enable field.

Table 11. Details about the RF enable field

File offset	b7	b6-b4	b3	b2-b1	b0
0x0006					
	0: the RF field is off ⁽¹⁾ 1: the RF field is on ⁽¹⁾				
	RFU				
	0: the RF disable pad is at low state ⁽¹⁾ 1: the RF disable pad is at high state ⁽¹⁾				
	RFU				
	0: the M24SR04 does not decode the command received from the RF interface 1: the M24SR04 decodes the command received from the RF interface				

1. this field is written by the M24SR04.

3.2 Read and write access rights to the memory

An NDEF file can be locked for read or write accesses. It is also protected by a 128-bit password that the host shall present before accessing the NDEF file. There are two 128-bit passwords, one for the read access and the other one for the write access.

An NDEF file can be permanently locked for read or write accesses. Thus, the host cannot access the NDEF file.

The read password shall be sent to the M24SR04 device before reading a read-locked NDEF file.

The write password shall be present on the M24SR04 device before writing a write-locked NDEF file. The write password shall be sent to change the read or write access. The read or write access right is defined for the NDEF file.

3.2.1 State of the Read and Write access rights

Two bytes in the CC file are used to define the Read and Write access rights to the NDEF file. For more details, refer to [Section 3.1.2: CC file layout](#).

Table 12. Read access right

Value	Meaning
0x00	Read access without any security
0x80	Locked ⁽¹⁾
0xFE	Read not authorized

1. The read password shall be sent before reading in the NDEF file.

Table 13. Write access right

Value	Meaning
0x00	Write access without any security
0x80	Locked ⁽¹⁾
0xFF	Write not authorized

1. The write password shall be sent before writing in the NDEF file.

The state 0xFF and 0xFE cannot be changed by using the Read or Write passwords.

3.2.2 Changing the read access right to NDEF files

The state diagram on [Figure 10](#) shows how to change the access right to read an NDEF file.

Figure 10. Changing the read access right to an NDEF file

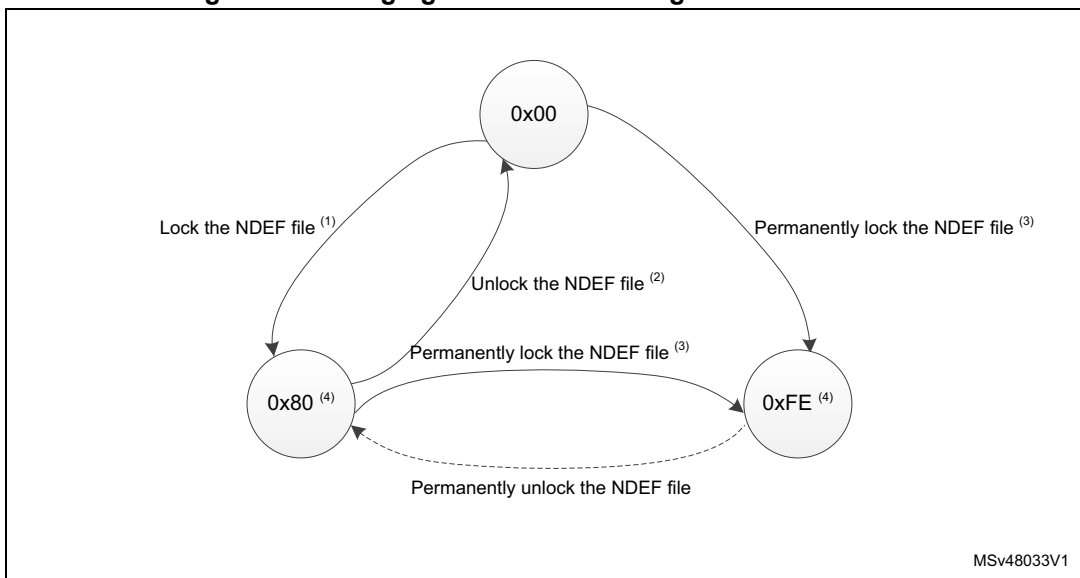

1. See the procedure to lock the read access ([Section 8.4: Locking an NDEF file](#)).
2. See the procedure to unlock the read access ([Section 8.5: Unlocking an NDEF file](#)).
3. See the procedure to permanently lock the read access ([Section 8.6: Reaching the read-only state for an NDEF file](#)).
4. Proprietary state, not defined by NFC Forum Type 4 Tag. For NFC Forum compatible tags, the only possible value of the read access rights are 0x00 (no restrictions on reads).

3.2.3 Changing the write access right to NDEF files

The state diagram on [Figure 11](#) shows how to change the write access right to an NDEF file.

Figure 11. Changing the write access right to an NDEF file



1. See the procedure to lock the write access.
2. See the procedure to unlock the write access.
3. See the procedure to permanently lock the write access ([Section 8.6: Reaching the read-only state for an NDEF file](#)).
4. Proprietary state, not defined by NFC Forum Type 4 Tag. For NFC Forum compatible tags, it is mandatory that the write access rights are set to either 0x00 (no restrictions on writes) or 0xFF (permanently locked). 0x80 might not be fully decoded with some smart phones.

3.3 Access right life time

The access right life time is validated while the NDEF file is selected or until the end of the RF or I²C session. Once the read or write access right is granted, the host can send one or more ReadBinary or UpdateBinary commands.

At the end of a session or when the host selects another file, the read and write access rights are initialized.

3.4 NDEF file passwords

The NDEF file passwords protect the read or write access from an RF or I²C interface from/to an NDEF file.

Two NDEF file passwords are available for each NDEF file:

- Read password
- Write password

The length of a password is 128 bits (16 bytes).

3.5 I²C password

The I²C password can be sent only by the I²C host. It activates the SuperUser rights. The I²C host with the SuperUser rights can:

- Access the NDEF file regardless of the right access and without sending the NDEF file passwords.
- Change the access rights regardless of the current state.

The length of the I²C password is 128 bits (16 bytes).

3.5.1 I²C password and I²C protect field of the System file

The I²C protect field in the system file can be set to:

- 0x00: the I²C host has the SuperUser right access without sending the I²C password
- 0x01: the I²C host has the SuperUser right access after sending the I²C password

For more details about the system file layout, refer to [Section 3.1.4: System file layout](#).

4 Communication mechanism

This chapter describes the principle of communication between an RF or an I²C host and the M24SR04 device.

4.1 Master and slave

The M24SR04 acts as a slave device on either the I²C-bus or the RF channel and therefore waits for a command from the I²C master or the RF host before sending its response.

The RF host shall generate the RF field and the RF commands.

The I²C host shall supply the M24SR04 through the V_{CC} pin and shall generate the I²C clock on the SCL pad.

4.2 M24SR04 session mechanism

The M24SR04 is a dynamic NFC/RFID tag which can be accessed either from the RF or I²C interface. The M24SR04 implements a token system. This token has two possible values, RF or I²C. When the token exists and is assigned to one interface (RF or I²C), the M24SR04 cannot communicate with the other host.

4.2.1 RF token

The token is given to the RF interface once the anticollision is done. The release condition can be either an RF field cut-off, or the reception of the command deselect, or when the I²C host sends the KillRFsession.

4.2.2 I²C token

The token is given to the I²C interface when the I²C host has sent the correct device Select. The release condition can be either a power down condition on V_{CC} pin or the reception of a I²C token release sequence from the I²C host, after which M24SR04 goes in Standby power mode.

5 I²C and RF command sets

The command sets of the M24SR04 can be split in different command families. Most commands are common between the RF and the I²C interface. Some commands are specific to the RF interface and some others are specific to the I²C interface. This section describes the M24SR04 command sets that can be issued by the RF or the I²C host.

There are three command families:

- the NFC Forum Type 4 Tag command set
- the ISO/IEC 7816-4 command set
- the proprietary command set

The NFC Forum Type 4 Tag command set and the ISO/IEC 7816-4 command set use the I-Block format. For more details about the I-Block format, refer to [Section 5.2: I-Block format](#).

Two other command formats exist:

- the commands using the R-Block format
- the commands using the S-Block format

For more details about these formats, refer to the corresponding sections: [Section 5.3: R-Block format](#) and [Section 5.4: S-Block format](#).

This section gives a brief description of the RF and I²C host common commands. The format of these command sets is the I-Block format.

[Table 14](#) lists the RF and I²C command sets.

Table 14. RF and I²C command sets

Family command set	Command name	Class byte	Instruction code	Brief description
NFC Forum Type 4 Tag	NDEF Tag Application Select	0x00	0xA4	NDEF Tag Application Select
	CC select	0x00	0xA4	Select the CC file
	NDEF select	0x00	0xA4	Select the NDEF file
	System select	0x00	0xA4	Select the system file
	ReadBinary	0x00	0xB0	Read data from file
	UpdateBinary	0x00	0xD6	Write or erase data to a NDEF file
ISO/IEC 7816-4	Verify	0x00	0x20	Checks the right access of a NDEF file or sends a password
	ChangeReferenceData	0x00	0x24	Change a Read or write password
	EnableVerificationRequirement	0x00	0x28	Activate the password security
	DisableVerificationRequirement	0x00	0x26	Disable the password security

Table 14. RF and I²C command sets (continued)

Family command set	Command name	Class byte	Instruction code	Brief description
ST Proprietary	EnablePermanentState	0xA2	0x28	Enables the Read Only or Write Only security state
ST Proprietary	ExtendedReadBinary	0xA2	0xB0	Read data from file

5.1 Structure of the command sets

The exchange of data between the RF or the I²C host and the M24SR04 uses three kinds of data formats, called blocks:

- I-Block: to exchange the command and the response
- R-Block: to exchange positive or negative acknowledgment
- S-Block: to use either the Deselect command or the Frame Waiting eXtension (WTX) command or response

Note: *max WTX value = 0x0B*

This section describes the structure of the I-Block, R-block and S-Block. This format is used for the application command set.

5.2 I-Block format

The I-Block is used to exchange data between the RF or the I²C host and the M24SR04. It is composed of three fields. [Table 15](#) details the I-Block format.

Table 15. I-Block format

Name	SoD		Payload	EoD
	PCB	DID	0	CRC
Length	1 byte	1 byte	1 to 251 bytes	2 bytes
PCB field				
DID field (optional)				
RF or I ² C host to M24SR04: C-APDU M24SR04 to RF or I ² C host: R-APDU				
2 CRC bytes				

Table 16. PCB field of the I-Block format

	b7-b6	b5	b4	b3	b2	b1	b0
	0b00	0	0	X	0	1	X
I-Block							
RFU							
Must be set to 0							
DID field, if bit is set							
Must be set to 0							
Must be set to 1							
Block number							

When the RF or I²C host sends a command to the M24SR04 the format of the payload is the C-APDU.

When the M24SR04 sends a command to the RF or I²C host, the format of the payload is the R-APDU.

5.2.1 C-APDU: payload format of a command

The C-APDU format is used by the RF or the I²C host to send a command to the M24SR04. [Table 17](#) describes its format.

Table 17. C-APDU format

Name	Payload field						
	CLA	INS	P1	P2	LC	Data	Le
Length	1 byte	1 byte	1 byte	1 byte	1 byte	Lc byte	1 byte
Class byte 0x00: standard command 0xA2: ST command							
Instruction byte							
Param Byte 1							
Param Byte 2							
Number of bytes of the Data field							
Data bytes							
Number of bytes to be read in the M24SR04 memory							

5.2.2 R-APDU: payload format of a response

the M24SR04 uses the I-Block format to reply to a command which used the I-Block format. This format is described in [Table 18](#).

Table 18. R-APDU format

Name	Payload field		
	Data (optional)	SW1	SW2
Length	Le byte	1 byte	1 byte
Data			
Status byte 1			
Status byte 2			

5.3 R-Block format

The R-Block is used to convey positive or negative acknowledgment between the RF or I²C host and the M24SR04.

Table 19. R-Block format

PCB	CRC
R(ACK) without the DID field: 0xA2 or 0xA3 R(ACK) with the DID field: 0xAA or 0xAB R(NAK) without the DID field: 0xB2 0xB3 R(NAK) with the DID field: 0xBA 0xBB	2 CRC bytes

There are two kinds of R-Blocks:

- R(ACK): the acknowledgment block sent by the RF or I²C host or by the M24SR04.
- R(NAK): the non-acknowledgment block sent by the RF or I²C host or by the M24SR04.

Table 20. R-Block detailed format

	b7-b6	b5	b4	b3	b2	b1	b0
	0b10	1	X	X	0	1	X
R-Block							
RFU							
1: NAK 0: ACK							
0: DID field is not present 1: DID field is present							
Must be set to 0							
Must be set to 1							
Block number							

5.4 S-Block format

The S-Block is used to exchange control information between a reader and a contactless tag.

Table 21. S-Block format

NFC frame	SoD			EoD
	PCB	DID	Payload	CRC
Length	1 byte	1 byte	0 to 1 bytes	2 bytes
0xC2: for S(DES) when the DID field is not present 0xCA: for S(DES) when the DID field is present 0xF2: for S(WTX) when the DID field is not present 0xFA: for S(WTX) when the DID field is present				
DID field (optional)				
WTX field ⁽¹⁾				
2 CRC bytes				

1. This field is present when b5-b4 bits are set to 0b11 (S-Block is a WTX). see [Table 22: S-Block detailed format](#).

There are two requests using the S-Block format:

- S(DES): the deselect command
- S(DES) is only applicable to RF
- S(WTX): the Waiting Frame eXtension command or response.

A Waiting Time eXtension request occurs, in RF or I²C, when the operating time needed by M24SRxx is greater than 9.6 ms.

The WTX field indicates the increase time factor to be used in this command execution (FDTtemp = WTX * 9.6 ms). The max WTX value is equal 0x0B.

Table 22. S-Block detailed format

	b7-b6	b5-b4	b3	b2	b1	b0
	0b11	X	X	0	1	0
S-Block						
0b00: Deselect 0b11: WTX						
0: DID field is not present 1: DID field is present						
-						
RFU						
RFU						

Note: After receiving the deselect command, the session is released and M24SR04 enters the Standby power mode. In I²C, the session is released after executing the I2C token release sequence.

In response to a RATS command, M24SR04 returns FWI parameter (default frame waiting time used); when M24SR04 needs more time for a command execution, it requests a frame waiting time extension by responding 0xF2 0xWTX (Request waiting time = FWI * WTX). If the reader accepts M24SR04 request, it acknowledges by sending the command 0xF2 0xWTX. The frame waiting time becomes FWI * WTX for the current command only.

5.5 CRC of the I²C and RF frame

The two CRC bytes check the data transmission between the RF host or I²C host and the M24SR04. For the RF frame, the CRC is computed on all the data bits in the frame, excluding parity bits, SOF and EOF, and the CRC itself.

For the I²C frames, the CRC is computed on all data bits of the frame excluding Device select and the CRC itself.

The CRC is as defined in ISO/IEC 13239. The initial register content shall be 0x6363 and the register content shall not be inverted after calculation.

5.6 NFC Forum Type 4 Tag protocol

5.6.1 Commands set

With the NFC Forum Type 4 Tag protocol, the commands are common to RF and I²C.

Table 23. Command set overview

Command name	Brief description
NDEF Tag Application Select	Select the NDEF Tag Application
Capability Container Select	Select the capability container (CC) file using the Select command
NDEF Select	Select the NDEF file
System File Select	Select the system file
ReadBinary	Read data from a file
UpdateBinary	Write new data to a file

5.6.2 Status and error codes

This section lists the status and the error code of the M24SR04.

Table 24. Status code of the M24SR04

	SW1	SW2	Comment
Value	0x90	0x00	Command completed successfully

Table 25. Error code of the M24SR04

	SW1	SW2	Comment
Length	1 byte	1 byte	
Value	0x62	0x80	File overflow (Le error)
Value	0x62	0x82	End of file or record reached before reading Le bytes
Value	0x63	0x00	Password is required
Value	0x63	0xCX	Password is incorrect, X further retries allowed (X can take value 0,1, 2)
Value	0x65	0x81	Unsuccessful updating
Value	0x67	0x00	Wrong length
Value	0x69	0x81	Cmd is incompatible with the file structure
Value	0x69	0x82	Security status not satisfied
Value	0x69	0x84	Reference data not usable

Table 25. Error code of the M24SR04 (continued)

	SW1	SW2	Comment
Length	1 byte	1 byte	
Value	0x6A	0x80	Incorrect parameters Le or Lc
Value	0x6A	0x82	File or application not found
Value	0x6A	0x84	File overflow (Lc error)
Value	0x6A	0x86	Incorrect P1 or P2 values
Value	0x6D	0x00	INS field not supported
Value	0x6E	0x00	Class not supported

5.6.3 NDEF Tag Application Select command

the RF or the I²C host shall send this command to activate the NDEF Tag Application.

To activate the NDEF Tag Application, the RF host sends the Select command (see [Table 26](#)) in addition to the sequence defined in the NFC Forum digital protocol.

To activate the NDEF Tag Application, the I²C host sends the Select command (see [Table 26](#)) in addition to the GetSession or the Kill RF session command.

[Table 26](#) defines the C-APDU of the Select command to select the NDEF Tag Application (called NDEF Tag Application Select).

Table 26. C-APDU of the NDEF Tag Application Select command

Name	CLA	INS	P1	P2	Lc	Data	Le
Value	0x00	0xA4	0x04	0x00	0x07	0xD27600 00850101	0x00
Class byte							
Select instruction code							
P1 field							
P2 field							
Number of bytes of data							
Application ID							
Le field							

[Table 27](#) defines the R-APDU of the NDEF Tag Application Select command.

Table 27. R-APDU of the NDEF Tag Application Select command

	Data	SW1	SW2	Comment
Length	-	1 byte	1 byte	-
Value	-	0x90	0x00	Command completed
Value	-	0x6A	0x82	NDEF Tag Application not found
Value	-	0x6D	0x00	Class not supported

5.6.4 Capability Container Select command

The RF or I²C host uses the Capability Container Select procedure to select the capability container (CC) file.

The CC file is selected when this command returns "command completed" in the R-APDU. [Table 28](#) defines the C-APDU of the Select command to select the CC file (called Capability Container Select).

Table 28. C-APDU of the Capability Container Select command

Name	CLA	INS	P1	P2	Lc	Data	Le
Value	0x00	0xA4	0x00	0x0C	0x02	0xE103	-
Class byte							
Select instruction code							
P1 field							
P2 field							
Number of bytes of data							
CC file ID							
-							

Table 29 defines the R-APDU of the CC Select command.

Table 29. R-APDU of the Capability Container Select command

	Data	SW1	SW2	Comment
Length	-	1 byte	1 byte	-
Value	-	0x90	0x00	Command completed
Value	-	0x6A	0x82	File or application not found
Value	-	0x6D	0x00	Class not supported

5.6.5 NDEF Select command

The RF or I²C host uses the NDEF Select command to select the NDEF file.

The NDEF file is selected when this command returns “command completed” in the R-APDU. Table 30 defines the C-APDU of the Select command to select the NDEF file (called NDEF Select).

In case of a password is required to access the NDEF file, the NDEF Select command will disable any previously granted access rights to this file. The Verify command might be required to access the file.

Table 30. C-APDU of the NDEF Select command

Name	CLA	INS	P1	P2	Lc	Data	Le
Value	0x00	0xA4	0x00	0x0C	0x02	0x000X	-
Class byte							
Select instruction code							
P1 field							
P2 field							
Number of bytes of data							
0x0001: first NDEF file							
-							

Table 31 defines the R-APDU of the NDEF Select command.

Table 31. R-APDU of the NDEF Select command

	Data	SW1	SW2	Comment
Length	-	1 byte	1 byte	-
Value	-	0x90	0x00	Command completed
Value	-	0x6A	0x82	File or application not found

5.6.6 System File Select command

The RF or I²C host uses this command to select the system file.

The System file is selected when this command returns "command completed" in the R-APDU.

Table 32 defines the C-APDU of the command to select the System file (called System Select).

Table 32. C-APDU of the System File Select command

Name	CLA	INS	P1	P2	Lc	Data	Le
	0x00	0xA4	0x00	0x0C	0x02	0xE101	-
Class byte							
Select instruction code							
P1 field							
P2 field							
Number of bytes of data							
System file ID							
-							

Table 33 defines the R-APDU of the System File Select command.

Table 33. R-APDU of the System File Select command

	Data	SW1	SW2	Comment
Length	-	1 byte	1 byte	-
Value	-	0x90	0x00	Command completed
Value	-	0x6A	0x82	Capability container not found, no data is returned

5.6.7 ReadBinary command

On receiving the ReadBinary command, the M24SR04 reads the requested memory field and sends back its value in the R-APDU response.

Before sending a ReadBinary command, a file shall be selected by using a Select command.

The Response of the ReadBinary command is successful when the data to be read is within the selected file ⁽¹⁾; in other words, when the sum of P1-P2 and Le fields is equal to or lower than the selected file length.

[Table 34](#) defines the ReadBinary command.

Table 34. C-APDU of the ReadBinary command

Name	CLA	INS	P1 & P2	Lc	Data	Le
	0x00	0xB0	2 bytes	-	-	1 byte
Class byte						
Read instruction code						
Offset in the file selected						
-						
-						
Number of bytes to read between 0x01 ≤ Le ≤ max(Selected File length, 0xF6)						

[Table 35](#) defines the R-APDU of the ReadBinary command.

Table 35. R-APDU of the ReadBinary command

	Data	SW1	SW2	Comment
Length	-	1 byte	1 byte	-
Value	Content read	0x90	Don't care ⁽¹⁾	Command completed
Value	-	0x67	0x00	Wrong length
Value	-	0x69	0x82	Security status not satisfied
Value	-	0x6A	0x82	File or application not found
Value	-	0x6E	0x00	Class not supported

1. For more information, please contact your local ST support.

1. For more details about CC file, refer to [Section 3.1.2: CC file layout](#).
 For more details about NDEF file, refer to [Section 3.1.3: NDEF file layout](#).
 For more details about System file, refer to [Section 3.1.4: System file layout](#).

5.6.8 UpdateBinary command

On receiving the UpdateBinary command, the M24SR04 writes the data field into the selected file and sends back a status in the R-APDU response. If needed, M24SRxx will request a timing extension (see [Section 5.4](#)).

Before sending an UpdateBinary command, a file shall be selected by issuing a Select command.

[Table 36](#) defines the UpdateBinary command.

Table 36. C-APDU of the UpdateBinary command

Name	CLA	INS	P1 & P2	Lc	Data	Le
	0x00	0xD6	2 bytes	1 byte	Lc bytes	-
Class byte						
Write instruction code						
Offset in the file selected						
Number of bytes of data (0x01 ≤ Lc ≤ 0xF6)						
Data to write in the M24SR04 memory						
-						

[Table 37](#) defines the R-APDU of the UpdateBinary command.

Table 37. R-APDU of the UpdateBinary command

	Data	SW1	SW2	Comment
Length	-	1 byte	1 byte	-
Value	-	0x90	0x00	Command completed
Value	-	0x65	0x81	Unsuccessful updating
Value	-	0x67	0x00	Wrong length
Value	-	0x69	0x82	Security status not satisfied
Value	-	0x6A	0x82	File or application not found
Value	-	0x6E	0x00	Class not supported

Note: Chaining is not supported on “UpdateBinay” command.
 For further return codes and definitions, refer to [Status and error codes](#).

5.7 ISO/IEC 7816-4 commands

The ISO/IEC 7816-4 command set offers some extended features such as the protection of the NDEF file. This command set is used to manage the right access of the NDEF file.

5.7.1 Verify command

The Verify command has two functions:

1. Check if a password is required to access to the NDEF file (the LC field = 0x00).
2. Check that the password embedded in the Verify command allows the access to the memory (the Lc field = 0x10 and the password is present).

When the Lc field is equal to 0x00, the verify command returns a success code (0x90 00) provided that the access to the NDEF file does not require a password. When the access to the NDEF file is protected, the response to the Verify command returns an error code (0x63 00).

When the Lc field equals 0x10, on receiving the Verify command, the M24SR04 compares the requested password with the data contained in the request and reports whether the operation has been successful in the response.

Before sending this command, an NDEF file shall be selected by issuing the NDEF Select command. Thus, this command checks the right access condition of the last NDEF file selected.

After a successful command, an access is granted for the whole NDEF file.

[Table 38](#) defines the Verify command.

Table 38. Verify command format

Name	CLA	INS	P1 & P2	Lc	Data	Le
	0x00	0x20	2 bytes	1 byte	Lc bytes	-
Class byte						
Instruction code						
Password identification 0x0001: Read NDEF password transmit 0x0002: Write NDEF password transmit 0x0003: I ² C password transmit ⁽¹⁾ Other: RFU						
0x00: the password is not present 0x10: the password is present in the data field						
Password -						

1. This code can only be issued by the I²C host.

Table 39 defines the R-APDU of the Verify command.

Table 39. R-APDU of the Verify command

	Data	SW1	SW2	Comment
Length	-	1 byte	1 byte	-
Value	-	0x90	0x00	Command completed, the password is correct
Value	-	0x69	0x85	The conditions of use are not satisfied (e.g. no NDEF file was selected)
Value	-	0x69	0x81	Cmd incompatible with file structure
Value	-	0x69	0x82	Security status not satisfied
Value	-	0x6A	0x80	Incorrect parameter in cmd data field
Value	-	0x63	0x00	A password is required
Value	-	0x63	0xCX ⁽¹⁾	The password transmitted is incorrect and X encodes the number of further allowed retries.
Value	-	0x6E	0x00	Class not supported

1. At each session, the RF or I²C host can check a password 3 times.

5.7.2 Change Reference Data command

The Change Reference Data command replaces the read or write password related to the NDEF files previously selected. It can be performed only if the security status satisfies the security attributes for this command.

Before sending this command, the verify command with the correct NDEF write password shall be issued. Thus, this command changes the reference data of the NDEF file.

Table 40 defines the Change Reference Data command.

Table 40. Change reference data command format

Name	CLA	INS	P1 & P2	Lc	Data	Le
	0x00	0x24	2 bytes	1 byte	Lc bytes	-
Class byte						
Instruction code						
Password identification 0x0001: Read password transmit 0x0002: Write password transmit 0x0003: I ² C password transmit ⁽¹⁾ Other: RFU						
0x10: the password is present in the data field						
NDEF file or I ² C Password						
-						

1. This code can only be issued by the I²C host.

Table 41 defines the R-APDU of the Change Reference Data command.

Table 41. R-APDU of the Change Reference Data command

	Data	SW1	SW2	Comment
Length	0	1 byte	1 byte	-
Value	-	0x90	0x00	Command completed, the access right has been changed
Value	-	0x69	0x81	Cmd is incompatible with the file structure
Value	-	0x65	0x81	Unsuccessful updating
Value	-	0x69	0x82	Security status not satisfied
Value	-	0x6A	0x80	CC file or System file selected
Value	-	0x6A	0x82	File or application not found
Value	-	0x6A	0x86	Incorrect P1 or P2 values
Value	-	0x6E	0x00	Class not supported

5.7.3 Enable Verification Requirement command

The Enable Verification Requirement command activates the protection by password of the NDEF file. When this command is successful, the read or write access to the NDEF file is protected by a 128-bit password. It can be performed only if the security status satisfies the security attributes for this command.

This command can update the right access of the NDEF file by writing into the EEPROM. In this case, the response timing will be around 5 ms.

Before sending this command, the verify command with the correct NDEF write password shall be issued. Thus, this command changes the access right of the NDEF file.

Table 42 defines the Enable Verification requirement command.

Table 42. Enable Verification Requirement command format

Name	CLA	INS	P1 & P2	Lc	Data	Le
	0x00	0x28	2 bytes	-	-	-
Class byte						
Instruction code						
New security attributes						
0x0001: Enable the read protection of the NDEF file						
0x0002: Enable the write protection of the NDEF file						
Other: RFU						
-						
-						
-						

The last five bits identify the password sent in the Verify command.

Table 43 defines the R-APDU of the Enable Verification Requirement command.

Table 43. R-APDU of the Enable Verification Requirement command

	Data	SW1	SW2	Comment
Length	0	1 byte	1 byte	-
Value	-	0x90	0x00	Command completed, the password is correct
Value	-	0x69	0x81	Cmd is incompatible with the file structure
Value	-	0x69	0x82	Security status not satisfied
Value	-	0x6A	0x80	CC file or System file selected
Value	-	0x6A	0x82	File or application not found
Value	-	0x6A	0x86	Incorrect P1 or P2 values

5.7.4 Disable Verification Requirement command

The Disable Requirement command deactivates the protection by password of the NDEF file. When this command is successful, the read or write access to the NDEF file is granted without security requirements. It can be performed only if the security status satisfies the security attributes for this command.

Before sending this command, the verify command with the correct NDEF write password shall be issued. Thus, this command changes the access right of the NDEF file.

This command can update the right access of the NDEF file by writing into the EEPROM. In this case, the response timing will be around 6 ms.

Table 44 defines the Disable Verification Requirement command.

Table 44. Disable Verification Requirement command format

Name	CLA	INS	P1 & P2	Lc	Data	Le
	0x00	0x26	2 bytes	-	-	-
Class byte						
Instruction code						
New security attributes 0x0001: Disable the read protection of the NDEF file 0x0002: Disable the write protection of the NDEF file Other: RFU						
-						
-						
-						

Table 45 defines the R-APDU of the Disable Verification Requirement command.

Table 45. R-APDU of the Disable Verification Requirement command

	Data	SW1	SW2	Comment
Length	0	1 byte	1 byte	-
Value	-	0x90	0x00	Command completed, the password is correct
Value	-	0x69	0x81	Cmd is incompatible with the file structure
Value	-	0x69	0x82	Security status not satisfied
Value	-	0x6A	0x80	CC file or System file selected
Value	-	0x6A	0x82	File or application not found
Value	-	0x6A	0x86	Incorrect P1 or P2 values
Value	-	0x6E	0x00	Class not supported
Value	-	0x65	0x81	Update failed

5.8 ST Proprietary command set

The RF or I²C host can be issued with the command set described in this chapter.

5.8.1 ExtendedReadBinary command

On receiving the ExtendedReadBinary command, the M24SR04 reads the requested memory field and sends back its value in the R-APDU response.

Before sending an ExtendedReadBinary command, a file shall be selected by issuing an NDEF select command.

The response of the ExtendedReadBinary command will be successful even if the data to be read is beyond the NDEF message. The command returns an error code if the data to be read goes beyond the end of the file.

Table 46. C-APDU of the ExtendedReadBinary command

Name	CLA	INS	P1 & P2	Lc	Data	Le
Length	0xA2	0xB0	2 bytes	-	-	1 byte
ST Class byte						
Read instruction code						
Offset in the file selected						
-						
-						
-						
Number of bytes to read between $0x01 \leq Le \leq 0xF6$						

[Table 47](#) defines the R-APDU of the read binary command.

Table 47. R-APDU of the ExtendedReadBinary command

	Data	SW1	SW2	comment
Length	Le bytes	1 byte	1 byte	-
Value	Content read	0x90	Don't care ⁽¹⁾	Command completed
Value	-	0x67	0x00	Wrong length
Value	-	0x69	0x82	Security status not satisfied
Value	-	0x6A	0x82	File or application not found
Value	-	0x6A	0x86	Incorrect P1 or P2 values
Value	-	0x6E	0x00	Class not supported

1. For more information, please contact your local ST support.

5.8.2 EnablePermanentState command

The command configures the NDEF file to the ReadOnly or to the WriteOnly State.

This command can update the right access to the NDEF file by writing into the EEPROM. In this case, the response timing will be around 6 ms.

[Table 48](#) defines the EnablePermanentState requirement command.

Table 48. EnablePermanentState command format

Name	CLA	INS	P1 & P2	Lc	Data	Le
Length	0xA2	0x28	2 bytes	-	-	-
Class byte						
Instruction code						
New security attributes 0x0001: Enable the read protection of the NDEF file 0x0002: Enable the write protection of the NDEF file Other: RFU						
-						
-						
-						
-						

[Table 49](#) defines the R-APDU of the EnablePermanentState command.

Table 49. R-APDU table of the EnablePermanentState command

	Data	SW1	SW2	comment
Length	-	1 byte	1 byte	-
Value	-	0x90	0x00	Command completed
Value	-	0x65	0x81	Update failed
Value	-	0x67	0x00	Wrong length

Table 49. R-APDU table of the EnablePermanentState command (continued)

	Data	SW1	SW2	comment
Value	-	0x69	0x82	Security status not satisfied
Value	-	0x6A	0x80	CC file or System file selected
Value	-	0x6A	0x82	File or application not found
Value	-	0x6A	0x86	Incorrect P1 or P2 values
Value	-	0x6E	0x00	Class not supported

5.8.3 DisablePermanentState command

The command configures the NDEF file to the Lock state.

This command can update the right access of the NDEF file by writing into the EEPROM. In this case, the response timing will be around 6 ms. This command is only valid in I²C. The SuperUser rights must have been granted to execute the command.

Before sending this command, an NDEF file shall be selected by issuing the NDEF Select command.

[Table 50](#) defines the DisablePermanentState requirement command.

Table 50. DisablePermanentState command format

Name	CLA	INS	P1 & P2	Lc	Data	Le
Length	0xA2	0x26	2 bytes	-	-	-
Class byte						
Instruction code						
New security attributes						
0x0001: Disable the read protection of the NDEF file						
0x0002: Disable the write protection of the NDEF file						
Other: RFU						
-						
-						
-						

[Table 51](#) defines the R-APDU of the DisablePermanentState command.

Table 51. R-APDU of the DisablePermanentState command

	Data	SW1	SW2	comment
Length	-	1 byte	1 byte	-
Value	-	0x90	0x00	Command completed
Value	-	0x65	0x81	Update failed
Value	-	0x67	0x00	Wrong length
Value	-	0x69	0x82	Security status not satisfied

Table 51. R-APDU of the DisablePermanentState command (continued)

	Data	SW1	SW2	comment
Value	-	0x6A	0x80	CC file or System file selected
Value	-	0x6A	0x82	File or application not found
Value	-	0x6A	0x86	Incorrect P1 or P2 values
Value	-	0x6E	0x00	Class not supported

5.8.4 UpdateFileType command

This command allows to modify the file type of a selected file to Proprietary file (0x05) or NDEF file (0x04).

NFC Forum compatible tags must configure the file as NDEF file (0x04).

This command is granted only, when application and file are selected and if the file length and access right have previously been set to 0X00h (message invalid, all access rights granted).

This command will update the file type located in the CC file by writing into the EEPROM. In this case, the response timing will be around 6 ms.

[Table 52](#) defines the UpdateFileType command.

Table 52. UpdateFileType command format

Name	CLA	INS	P1	P2	Lc	Data	Le
Value	0xA2	0xD6	0x00	0x00	0x01	0x04 or 0x05	-
Class byte							
Select instruction code							
P1 field							
P2 field							
Number of bytes of data							
File type							
-							

[Table 53](#) describes the R-APDU of the UpdateFileType command.

Table 53. R-APDU of the UpdateFileType command

	Data	SW1	SW2	Comment
Length	-	1 byte	1 byte	-
Value	-	0x90	0x00	Command completed
Value	-	0x69	0x82	Security status not satisfied
Value	-	0x6A	0x80	CC file or System file selected

Table 53. R-APDU of the UpdateFileType command (continued)

	Data	SW1	SW2	Comment
Value	-	0x6A	0x82	File or application not found
Value	-	0x6A	0x86	Incorrect P1 or P2 values

5.8.5 SendInterrupt command

On receiving the SendInterrupt command, the M24SR04 generates a negative pulse on the GPO pin. It starts at the end of the command and ends at the end of the RF response.

Before sending this command, the system file shall be selected by issuing the System Select command.

[Table 54](#) defines the SendInterrupt command.

Table 54. SendInterrupt command format

	CLA	INS	P1&P2	Lc	Data	Le
Length	1 byte	1 byte	2 bytes	1 byte	-	-
Value	0xA2	0xD6	0x001E	0x00	-	-

[Table 55](#) describes the R-APDU of the SendInterrupt command.

Table 55. R-APDU of the SendInterrupt command

	Data	SW1	SW2	Comment
Length	-	1 byte	1 byte	-
Value	-	0x90	0x00	The interrupt has been sent
Value	-	0x6A	0x80	The GPO is not configured as an interrupt mode
Value	-	0x6A	0x82	File or application not found
Value	-	0x6A	0x86	Incorrect P1 or P2 values
Value	-	0x6E	0x00	Class not supported

5.8.6 StateControl command

On receiving the StateControl command with reset value: data 0x00, the M24SR04 drives the GPO pin low. On receiving the StateControl command with set value: data 0x01, the M24SR04 releases the GPO pin which returns to HZ.

Before sending this command, the system file shall be selected by issuing the System Select command.

[Table 56](#) defines the State Control command.

Table 56. StateControl command format

	CLA	INS	P1&P2	Lc	Data	Le
Length	1 byte	1 byte	2 bytes	1 byte	-	-
Reset value	0xA2	0xD6	0x001F	0x01	0x00	-
Set value	0xA2	0xD6	0x001F	0x01	0x01	-

Table 57. R-APDU of the StateControl command

	Data	SW1	SW2	Comment
Length	-	1 byte	1 byte	-
Value	-	0x90	0x00	The set or reset has been sent
Value	-	0x6A	0x80	The GPO is not configured in StateControl mode
Value	-	0x6A	0x82	File or application not found
Value	-	0x6A	0x86	Incorrect P1 or P2 values
Value	-	0x6E	0x00	Class not supported

5.9 Specific RF command set

This section describes the command set that can be issued only by the RF host.

5.9.1 Anticollision command set

[Table 58](#) lists the commands that can be issued only by the RF host. The format of these commands is described in the NFC Forum Digital Protocol specification.

Table 58. Commands issues by the RF host

Family command set	Command name	Instruction code
NFC-A technology	ALL_REQ	0x52 ⁽¹⁾
	SENS_REQ	0x26 ⁽¹⁾
	SDD_REQ	0x93 or 0x95 or 0x97
	SEL_REQ	0x93 or 0x95 or 0x97
	SLP_REQ	0x50

1. Code on 7 bits.

5.9.2 RATS command and ATS response

RATS command and ATS response are used for NFC Forum Type 4A Tag Platform Device Activation (as defined in NFC Forum Digital Protocol specification).

[Table 59](#) details the RATS command. This command shall be sent after the anticollision process.

Table 59. RATS command

Name	INS	Param		CRC
Byte field	0xE0	1 byte		2 bytes
Bit field		b7-b4	b3-b0	
Instruction code				
FSDI				
DID (0 ≤ DID ≤ 14)				
2 CRC bytes				

The FSDI field codes the FSD that defines the maximum size that an RF or I²C host is able to receive. [Table 60](#) gives the conversion from FSDI to FSD.

Table 60. Conversion from FSDI to FSD

FSDI	0x0	0x1	0x2	0x3	0x4	0x5	0x6	0x7	0x8	0x9h-0xE	0xF
FSD	16	24	32	40	48	64	96	128	256	RFU	256

The DID field defines the value of the addressed M24SR04.

Table 61. ATS response

Name	TL	T0	TA(1)	TB(1)		TC(1)	CRC
Byte field	0x05	0x78	1 byte	1 byte		0x02	2 bytes
Bit field				b8-b5	b4-b1		
Length of the ATS response							
FSCI = 256 bytes							
The maximum ascending data rate is 106 kbps The maximum descending data rate is 106 kbps							
FWI field (9.6 ms when TB = 0x50)							
SFGI field (302 μs when TB = 0x50)							
The DID is supported							
2 CRC bytes							

The FSCI codes the FSC which stands for the maximum frame size that the M24SR04 is able to receive. The M24SR04 is able to receive up to 256 bytes of command. If the RF or I²C host sends a command with more than 256 bytes, the M24SR04 will not be able to treat the command and will not reply.

The FWI which stands for the Frame Waiting time Integer codes the FWT. This time corresponds to the maximum duration while an RF or I²C host shall send before sending the next command.

The SFGI which stands for the Start-up Frame Guard Time is the minimum time that the reader shall wait after receiving the response of the M24SR04.

5.9.3 PPS command & response

PPS (Protocol and Parameter Selection) command and response are defined in ISO/IEC 14443-4, in the Protocol Activation of PICC Type A.

The PPS command allows to change the data rates of the ascending (RF host to M24SR04) and descending (M24SR04 to RF host) data rates.

Table 62. PPS command

-	Name	INS		PPS0	PPS1			CRC
	Byte field	0xDX		0x11	1 byte			2 bytes
	Bit field	b7-b4	b3-b0		0b0000	b3-b2	b1-b0	
INS	Instruction code							
	DID							
	PPS1 is present							
PPS1	RFU							
	Descending data rate							
	Ascending data rate							
	2 CRC bytes							

The ascending and descending data rates shall be coded as described in [Table 63](#).

Table 63. Ascending and descending data rate coding

Value	0b00	0b01	0b10	0b11
Data rate	106 kbps	RFU	RFU	RFU

When the M24SR04 is able to change both data rates, it returns the following response. The data rate of this response is 106 kbps; then, the M24SR04 changes the ascending and descending data rates.

[Table 64](#) gives the details of the PPS response.

Table 64. PPS response

Name	INS	-	PPS0
Byte field	0xDX	-	0x11
Bit field	b8-b5	b4-b1	
Response code			
DID field			
2 CRC bytes			

5.10 Specific I²C command set

[Table 65](#) lists the commands that can only be issued by the I²C host.

Table 65. Specific I²C commands

Command name	Format	Class byte	Instruction code	Brief description
GetI2Csession	-	-	0x26	Open an I ² C session when the RF session is not ongoing
KillRFsession	-	-	0x52	Kill the RF session and open an I ² C session

5.10.1 GetI2Csession command

The GetI2Csession command opens an I²C session if an RF session is not ongoing.

[Table 66](#) defines the GetI2Csession command.

Table 66. GetI2Csession command format

	INS
Length	1 byte
Value	0x26

The GetI2Csession command does not create a reply.

When an RF session is ongoing, the M24SRxx will not acknowledge the command.

When no RF session is ongoing, the M24SRxx will acknowledge the command and open an I²C session.

5.10.2 KillRFsession command

The KillRF session command closes the RF session and opens an I²C session.

[Table 67](#) defines the KillRFsession command.

Table 67. KillRFsession command format

	INS
Length	1 byte
Value	0x52

The KillRFsession command does not create a reply. The RF session is closed when the device acknowledges the command.

Caution: A successful completion of the RF command is not certain.

6 RF device operation

6.1 Anticollision and Device Activation command set for the RF interface

The M24SR04 device supports the command set defined in the NFC-A Technology and the Type 4A Tag Platform chapters of the NFC Digital Protocol V1.0 specification.

6.2 Open an RFsession

Once the RF host has terminated the anticollision procedure and retrieve the ATS response, it shall send the SelectApplication command. The M24SR04 will open an RF session. At this point, the RF host can send the applicative command set and the I²C cannot communicate with the M24SR04 without closing first the RF session using the I²C KillRFsession command.

6.3 Close an RFsession

The RF host can close the RF session by issuing one of these methods:

- send an S(DES) command
- turn off the RF field

6.4 Applicative command set

The applicative command set is composed of the following command sets:

- the NFC Forum Type 4 Tag command set
- the ISO/IEC 7816-4 command set
- the proprietary command set

7 I²C device operation

The M24SR04 device supports the I²C protocol. The device that controls the data transfer is known as the bus master, and the other one as the slave device. A data transfer can only be initiated by the bus master, which also provides the serial clock for synchronization. The M24SR04 device is a slave in all communications.

7.1 I²C communication protocol

The I²C communication is built on a system of command and reply exchange. The I²C host starts the communication by sending a request. Once a valid request is received by the M24SR04 device, it carries out an internal operation and creates its answer.

As defined in this document, and except for the GetI2C session and Kill RF session commands, the definition of a valid request is a command with a right CRC value.

Figure 12 shows an exchange of a command and a response between the I²C host and the M24SR04. Once the I²C session is open, the I²C host can send a command. The command is composed of:

- a Device Select field with the R/W bit set to 0.
- the command field.

The M24SR04 acknowledges on the reception of each byte.

Once the M24SR04 is ready to send the answer, the I²C host shall:

- send a Device Select field with the R/W bit set to 1.
- release the SDA line and send an SCL clock.

The I²C host shall acknowledge on the reception of each byte.

Figure 12. Command and response exchange



Legend:

S is the I²C Start bit sequence

P is the I²C Stop bit sequence

R/W is the 8th bit of Device Select.

Note: A restart during a command and response exchange is not supported by the M24SR04.

After a command, the I²C host can execute a Polling sequence to determine when the response is available.

Polling sequence: Loop on < START (S) + DeviceSelect with RW=0 + read NACK/ACK + STOP (P) >

The response is available as soon as the M24SR04 sends an ACK (host read will a '0').

7.2 Start condition

A Start condition is identified by a falling edge of serial data (SDA) while the serial clock (SCL) is stable in the high state. A Start condition must precede any data transfer command. The device continuously monitors (except during an instruction processing) the SDA and the SCL for a Start condition, and does not respond unless one is given.

7.3 Stop condition

A Stop condition is identified by a rising edge of serial data (SDA) while the serial clock (SCL) is stable and driven high. A Stop condition terminates a command between the device and the bus master.

7.4 I²C token release sequence

As explained in the M24SR04-Y M24SR04-G session mechanism, the I²C communication is reserved to the I²C host when the session token has the I²C value.

The following sequence explains how to release the I²C value of the session token.

I²C communication with the M24SR04 starts with a valid Start condition, followed by a device select code.

If the delay between the Start condition and the following rising edge of the Serial Clock (SCL) that samples the most significant of the Device Select exceeds the $t_{START_OUT_MAX}$ time (see [Table 78](#)), the I²C logic block is reset and further incoming data transfer is ignored until the next valid Start condition.

Figure 13. I²C token release sequence



Note: *If the above delay is below $t_{START_OUT_min}$ (see [Table 78](#)), I²C session token stays unmodified.
If the delay is between $t_{START_OUT_min}$ and $t_{START_OUT_max}$, I²C session token might or not be released. This range of delay is not authorized for safe operation.*

7.5 I²C timeout on clock period

During a data transfer on the I²C bus, if the serial clock high pulse or serial clock low pulse exceeds t_{CL_RESET} value that is the maximum value specified in [Table 78](#), the I²C logic block is reset and any further incoming data transfer is ignored until the next valid Start condition.

If the serial clock high pulse is under the maximum value of t_{CHCL} and the serial clock low pulse is under the maximum value of t_{CLCH} in [Table 78](#), the I²C logic block is not reset.

For proper operation, the serial clock high pulse should not be higher than t_{CHCL} and lesser than t_{CL_RESET} , and the serial clock low pulse should not be higher than t_{CHCH} and lesser t_{CL_RESET} .

7.6 Acknowledge bit (ACK)

The acknowledge bit is used to indicate a successful byte transfer. The bus transmitter, whether a bus master or a slave device, releases the serial data (SDA) after sending eight bits of data. During the 9th clock pulse period, the receiver pulls the SDA low to acknowledge the receipt of the eight data bits.

7.7 Data input

During data input, the device samples serial data (SDA) on the rising edge of the serial clock (SCL). For a correct device operation, the SDA must be stable during the rising edge of the SCL, and the SDA signal must change only when the SCL is driven low.

7.8 I²C device address

The device address is the concatenation of the group number coded on 4 bits and the I²C address coded on 3 bits, as shown in [Table 68](#).

Table 68. I²C device address format

	b7-b4	b3	b2	b1	b0
	0b1010	1	1	0	0bx
Group number					
E2 bit					
E1 bit					
E0 bit					
0 = Request 1 = Answer					

7.9 I²C frame format

The I²C frame is composed of three fields:

1. SOD field: contains the device select and the PCB. The PCB field is detailed in [Section 5.2](#).
2. Payload field: contains the command and its parameter, as defined in the I²C command set.
3. EOD field: contains the two CRC bytes computed on the SOD but excluding the device select byte field.

[Table 69](#) shows the format of an I²C frame.

Table 69. I²C frame format

I ² C frame	SOD		Payload	EOD
	0xAC or 0xAD	1 byte	1 to 251 bytes	2 bytes
Device select 0xAC: to send a request to the M24SR04 0xAD: to read a response of the M24SR04				
PCB field				
I ² C command or I ² C answer				
2 CRC bytes				

7.9.1 Example of I²C frame commands

NDEF Tag Application command

This example presents the I²C frame of an NDEF Tag Application Select command. The I²C frame is detailed in [Table 70](#).

Table 70. I²C host to M24SR04

Field	SOD		Payload	EOD
Value	0xAC	0x02 or 0x03	Command field	35 C0 or DF BE
Device select				
PCB field				
0x00 A4 04 00 07 D2 76 00 00 85 01 01 00				
2 CRC bytes				

Before sending a new command, the I²C host can send an I²C frame to read the M24SR04 answer to the NDEF tag Application Select command.

Table 71. M24SR04 to I²C host

Field	SOD	Payload	EOD
	I ² C host to M24SR04	M24SR04 to I ² C host	
Value	0xAD	0x02 or 0x03	0x90 00
Device select			
PCB field			
I ² C command			
2 CRC bytes			

Figure 14 shows the I²C frame of the NDEF tag Application Select command.

Figure 14. NDEF tag Application Select command

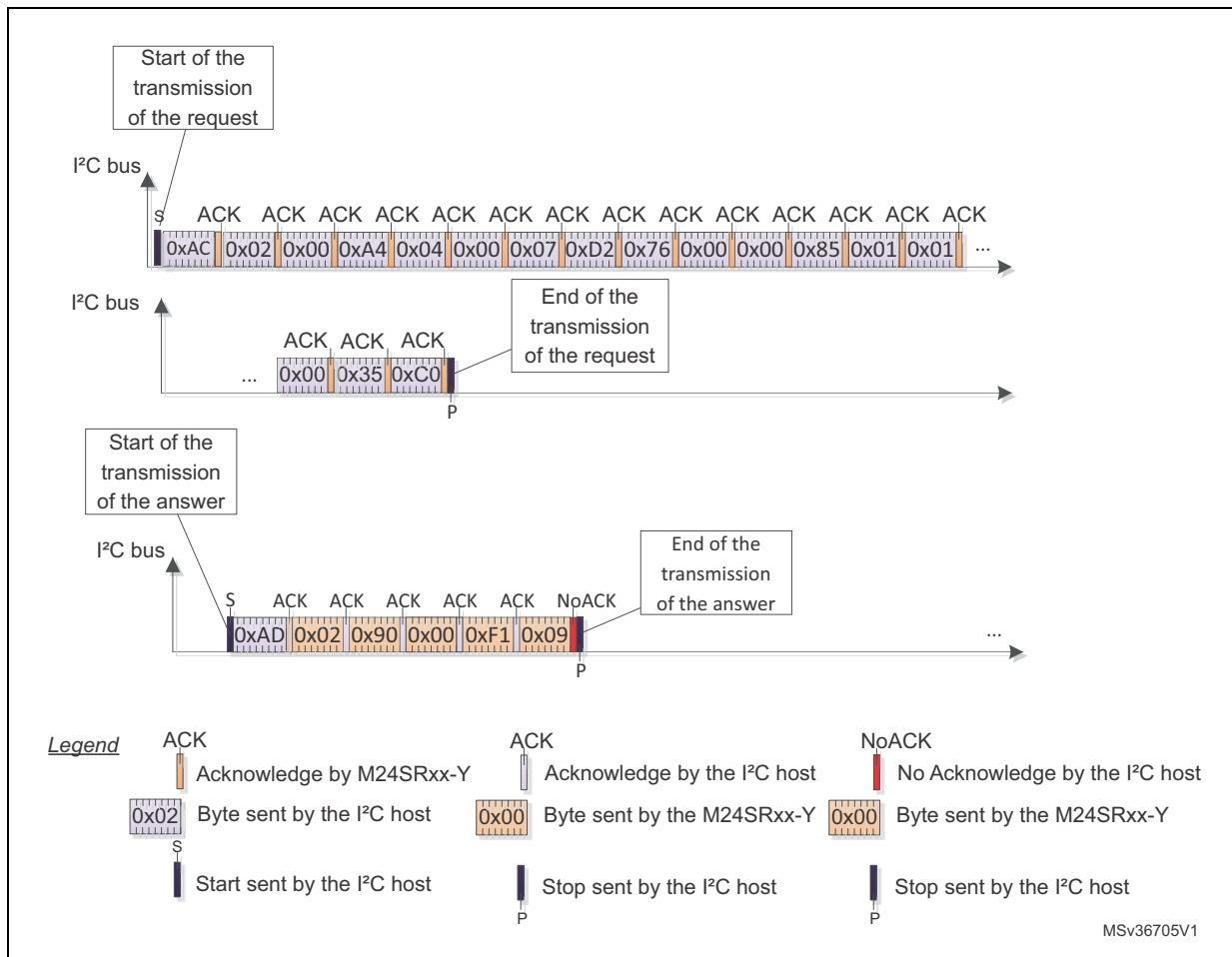

7.10 Open an I²C session

To open an I²C session, the I²C host shall send either the GetSession command or the KillRFsession command. The GetSession Command opens an I²C session if an RF session is not currently opened.

A KillRFsession command closes the current RF session if it exist and opens an I²C session.

When an I²C session is opened, the RF host cannot communicate with the M24SR04 and cannot close the I²C session.

7.11 Close the I²C session

There are three ways to close an I²C session:

- turn off the Vcc power supply
- send the I2C token release sequence
- wait for the I²C watchdog when it is enabled
- wait for the I²C timeout on clock period

8 Functional procedures

This section describes some procedure to access the memory or manage its protection.

8.1 Selection of an NDEF message

The RF or I²C host shall use this procedure to detect the NDEF message inside an M24SR04.

The NDEF detection procedure is as follows:

1. Open an RF or an I²C session
2. Send the SelectNDEFTagApplication command
3. Select the CC file
4. Read the CC file
5. Select the NDEF file.

8.2 Reading of an NDEF message

The RF or I²C host executes the NDEF read procedure to read the NDEF file.

1. Detect successfully the NDEF file using the NDEF detection procedure
2. Check that the read access without any security is granted for the NDEF file from the information provided by the CC file
3. Select the NDEF file
4. Read the NDEF file.

Note: Reading the NDEF file should not go beyond the NDEF Length field (NLEN), which indicates the size of the NDEF message stored in the NDEF file.

8.3 Reading a locked NDEF file

The RF or I²C host executes this procedure to read an NDEF file which has been locked previously.

1. Select the NDEF Tag Application
2. Select the NDEF file
3. Verify the Read password by using the Verify command
4. Read the data in the NDEF file.

8.4 Locking an NDEF file

The RF or I²C host executes this procedure to protect an NDEF file.

1. Select the NDEF Tag Application
2. Check the right access provided by the CC file
3. Select the NDEF file
4. Transmit the NDEF file Write password by using the Verify command
5. Lock the NDEF file by sending the Enable verification command.

8.5 Unlocking an NDEF file

The RF or I²C host executes this procedure to unlock an NDEF file which has been locked previously.

1. Select the NDEF Tag Application
2. Select the NDEF file
3. Verify the NDEF file Write password or the I²C password by using the Verify command
4. Unlock the NDEF file by sending the Disable verification command.

8.6 Reaching the read-only state for an NDEF file

The RF or I²C host executes this procedure to reach the read-only state for an NDEF file.

1. Select the NDEF Tag Application
2. Select the NDEF file
3. Transmit the NDEF file Write password or the I²C password by using the Verify command
4. Send an EnablePermanentState command as the Write access right of the previous Select NDEF file.

8.7 Changing an NDEF password procedure

The RF or I²C host could use this procedure to change one NDEF password. it can be a Read or Write password.

1. Select the NDEF Tag Application
2. Select the NDEF file
3. Transmit the NDEF file Write password or the I²C password by using the Verify command
4. Change the password by sending a ChangeReferenceData command.

8.8 Changing a File type Procedure

The RF or I²C host executes this procedure to change the File Type of a file for which all access rights were previously granted.

1. Select the NDEF Tag Application
2. Select the File to be modified
3. Set the File Length to 0x00 using the UpdateBinary command
4. Send an UpdateFileType command with the New file Type as data.

8.9 Updating a NDEF file

When there's enough space in the file to update it with new content, the following steps should be followed to update the NDEF message:

1. Select the NDEF Tag Application
2. Select the NDEF file
3. Unlock the NDEF file if necessary
4. Write the NDEF length to 0x0000 with the Update Binary command.
5. Write the NDEF message in the NDEF message field using one or more Update Binary commands.
6. Write the NDEF length of the NDEF message using the Update Update command.

It is recommended the NDEF length is read back and checked against the desired value to ensure the Update sequence has been correctly performed.

9 UID: Unique identifier

The M24SR04 is uniquely identified by a 7 bytes unique identifier (UID). The UID is a read-only code and comprises:

- The IC manufacturer code on 1 byte (0x02 for STMicroelectronics).
- The Product code on 1 byte.
- A device number on 5 bytes.

[Table 72](#) describes the UID format.

Table 72. UID format

	0x02	0x86	5 bytes
IC manufacturer code			
M24SR04 product code			
Device number			

10 Maximum ratings

Stressing the device above the ratings listed in [Table 73](#) may cause permanent damage to the device. These are stress ratings only and operation of the device at these or any other conditions above those indicated in the operating sections of this specification is not implied. Exposure to absolute maximum rating conditions for extended periods may affect the device reliability.

Table 73. Absolute maximum ratings

Symbol	Parameter		Min.	Max.	Unit
T _A	Ambient operating temperature for grade 6		- 40	85	°C
	Ambient operating temperature for grade 5		- 25	85	
T _{STG}	Storage temperature	UFDFPN8, SO8, TSSOP8	- 65	150	°C
	Storage temperature	Sawn Bumped Wafer (kept in its antistatic bag)	15	25	°C
	Storage time		-	9	months
T _{LEAD}	Lead temperature during soldering	UFDFPN8, SO8, TSSOP8	see note ⁽¹⁾		°C
V _{IO}	I ² C input or output range and GPO		- 0.50	6.5	V
I _{CC} ⁽²⁾	RF supply current AC0 - AC1		-	100	mA
V _{MAX_1} ⁽²⁾	RF input voltage amplitude between AC0 and AC1, GND pad left floating	VAC0-VAC1	-	10	V
V _{MAX_2} ⁽²⁾	AC voltage between AC0 and GND, or AC1 and GND	VAC0-GND or VAC1-GND	- 0.5	4.5	V
V _{ESD}	Electrostatic discharge voltage (human body model) ⁽³⁾	AC0-AC1	-	1000	V
V _{ESD}	Electrostatic discharge voltage (human body model) ⁽³⁾	Other pads	-	3500	V

1. Compliant with JEDEC Std J-STD-020D (for small body, Sn-Pb or Pb assembly), the ST ECOPACK[®] 7191395 specification, and the European directive on Restrictions on Hazardous Substances (ROHS directive 2011/65/EU, July 2011).

2. Based on characterization, not tested in production. Maximum absorbed power = 100 mW @ 7.5 A/m

3. AEC-Q100-002 (compliant with JEDEC Std JESD22-A114A, C1 = 100 pF, R1 = 1500 Ω, R2 = 500 Ω)

11 I²C DC and AC parameters

This section summarizes the operating and measurement conditions, and the DC and AC characteristics of the device in I²C mode. The parameters in the DC and AC characteristic tables that follow are derived from tests performed under the measurement conditions summarized in the relevant tables. Designers should check that the operating conditions in their circuit match the measurement conditions when relying on the quoted parameters.

Table 74. I²C operating conditions

Symbol	Parameter	Min.	Max.	Unit
V _{CC}	Supply voltage range Y	2.7	5.5	V
	Supply voltage range G	2.4	5.5	
T _A	Ambient operating temperature for grade 6	-40	85	°C
	Ambient operating temperature for grade 5	-25	85	

Table 75. AC test measurement conditions

Symbol	Parameter	Min.	Max.	Unit
C _L	Load capacitance	100		pF
t _r , t _f	Input rise and fall times	-	50	ns
V _{hi-lo}	Input levels	0.2 V _{CC} to 0.8 V _{CC}		V
V _{ref(t)}	Input and output timing reference levels	0.3 V _{CC} to 0.7 V _{CC}		V

Figure 15. AC test measurement I/O waveform

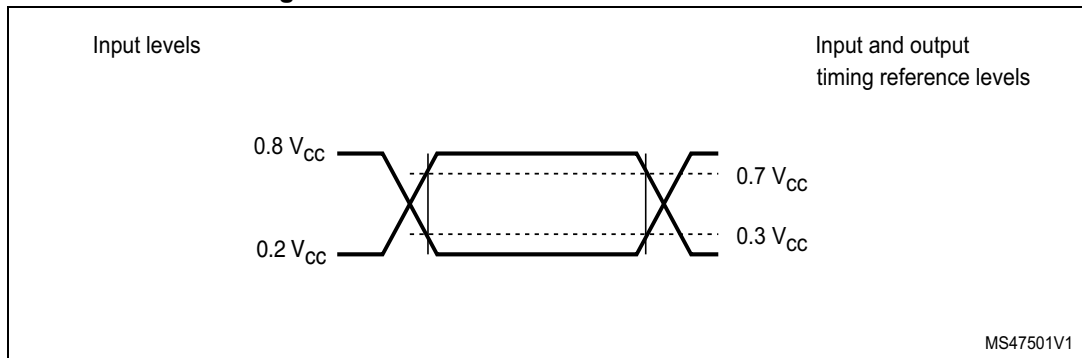

Table 76. Input parameters

Symbol	Parameter	Min.	Max.	Unit
C _{IN}	Input capacitance (SDA)	-	8	pF
C _{IN}	Input capacitance (other pins)	-	6	pF
t _{NS}	Pulse width ignored (Input filter on SCL and SDA)	-	80	ns

Table 77. I²C DC characteristics

Symbol	Parameter	Test condition	Min.	Max.	Unit
I _{LI}	Input leakage current (SCL, SDA)	V _{IN} = V _{SS} or V _{CC} device in Standby mode	-	± 2	μA
I _{LO}	Output leakage current	SDA in Hi-Z, external voltage applied on SDA: V _{SS} or V _{CC}	-	± 2	μA
I _{CC0}	Standby power mode supply current	V _{CC} = 3.3 V, with RF ON	-	30	μA
		V _{CC} = 3.3 V, with RF OFF	-	5	
		V _{CC} = 5.5 V, with RF ON ⁽¹⁾	-	30	
		V _{CC} = 5.5 V, with RF OFF	-	5	
I _{CC1}	Supply current (I ² C Session open)	V _{CC} = 3.3 V, with RF ON	-	150	μA
		V _{CC} = 3.3 V, with RF OFF	-	150	
		V _{CC} = 5.5 V, with RF ON	-	150	
		V _{CC} = 5.5 V, with RF OFF	-	150	
I _{CC2}	Supply current ⁽²⁾ (Read binary)	V _{CC} = 3.3 V (f _C = 1 MHz), with RF ON ⁽³⁾	-	250	μA
		V _{CC} = 3.3 V (f _C = 1 MHz), with RF OFF ⁽³⁾	-	200	
		V _{CC} = 5.5 V (f _C = 1 MHz), with RF ON ⁽³⁾	-	250	
		V _{CC} = 5.5 V (f _C = 1 MHz), with RF OFF ⁽³⁾	-	200	
I _{CC3}	Supply current ⁽²⁾ (Update binary)	V _{CC} = 3.3 V (f _C = 1 MHz), with RF ON ⁽³⁾	-	550	μA
		V _{CC} = 3.3 V (f _C = 1 MHz), with RF OFF ⁽³⁾	-	500	
		V _{CC} = 5.5 V (f _C = 1 MHz), with RF ON ⁽³⁾	-	550	
		V _{CC} = 5.5 V (f _C = 1 MHz), with RF OFF ⁽³⁾	-	500	
V _{IL}	Input low voltage (SDA, SCL)	V _{CC} = 2.7 V (grade Y) V _{CC} = 2.4 V (grade G) V _{CC} = 5.5 V	-0.45	0.3 V _{CC}	V
V _{IH}	Input high voltage (SDA, SCL)	V _{CC} = 2.7 V (grade Y) V _{CC} = 2.4 V (grade G) V _{CC} = 5.5 V	0.7 V _{CC}	6.5	V
V _{IL}	Input low voltage (RF disable)	V _{CC} = 2.7 V (grade Y) V _{CC} = 2.4 V (grade G) V _{CC} = 5.5 V	-	0.45	V
V _{IH}	Input high voltage (RF disable)	V _{CC} = 2.7 V (grade Y) V _{CC} = 2.4 V (grade G) V _{CC} = 5.5 V	1.4	-	V
V _{OL}	Output low voltage (SDA)	I _{OL} = 3 mA, V _{CC} = 5.5 V	-	0.4	V
	Output low voltage (GPO)	I _{OL} = 1 mA, V _{CC} = 2.7 V (grade Y) or 2.4 V (grade G) to V _{CC} = 5.5 V	-	0.4	V

1. When an RF session is Opened, I_{CC} corresponds to the standby power mode.

2. Characterized only.

3. Input levels as defined in [Figure 15](#).

Table 78. I²C AC characteristics (400 kHz)

Test conditions specified in Table 74 (preliminary data based on design simulations)					
Symbol	Alt.	Parameter	Min.	Max.	Unit
f_C	f_{SCL}	Clock frequency	0.05	400	kHz
$t_{CHCL}^{(1)}$	t_{HIGH}	Clock pulse width high	0.6	20000	μs
$t_{CLCH}^{(2)}$	t_{LOW}	Clock pulse width low	1.3	20000	μs
t_{CL_reset}	-	Clock reset	40000	-	μs
t_{XH1XH2}	t_R	Input signal rise time	(3)	(3)	ns
t_{XL1XL2}	t_F	Input signal fall time	(3)	(3)	ns
t_{DL1DL2}	t_F	SDA (out) fall time	20	300	ns
t_{DXCX}	$t_{SU:DAT}$	Data in set up time	100	-	ns
t_{CLDX}	$t_{HD:DAT}$	Data in hold time	0	-	ns
$t_{CLQX}^{(4)}$	t_{DH}	Data out hold time	100	-	ns
$t_{CLQV}^{(5)}$	t_{AA}	Clock low to next data valid (access time)	-	900	ns
$t_{CHDX}^{(6)}$	$t_{SU:STA}$	Start condition set up time	600	-	ns
t_{DLCL}	$t_{HD:STA}$	Start condition hold time	600	-	ns
t_{CHDH}	$t_{SU:STO}$	Stop condition set up time	600	-	ns
t_{DHDL}	t_{BUF}	Time between Stop condition and next Start condition	1300	-	ns
t_W	t_{WR}	I ² C write time in one page	-	5	ms
		I ² C write time up to 246 bytes	-	90	ms
$t_{NS}^{(7)}$	-	Pulse width ignored (input filter on SCL and SDA)	-	80	ns
t_{START_OUT}	-	Delay for I ² C token release	20	40	ms

- t_{CHCL} timeout.
- t_{CLCH} timeout.
- There is no min. or max. value for the input signal rise and fall times. It is however recommended by the I²C specification that the input signal rise and fall times be more than 20 ns and less than 300 ns when $f_C < 400$ kHz.
- To avoid spurious Start and Stop conditions, a minimum delay is placed between SCL=1 and the falling or rising edge of SDA.
- t_{CLQV} is the time (from the falling edge of SCL) required by the SDA bus line to reach $0.8V_{CC}$ in a compatible way with the I²C specification (which specifies $t_{SU:DAT}(\min) = 100$ ns), assuming that the $R_{bus} \times C_{bus}$ time constant is less than 500 ns (as specified in [Figure 17](#)).
- For a restart condition, or following a write cycle.
- Characterized only, not tested in production.

Table 79. I²C AC characteristics (1 MHz)

Test conditions specified in Table 74 (preliminary data based on design simulations)					
Symbol	Alt.	Parameter	Min.	Max.	Unit
f_C	f_{SCL}	Clock frequency	0.05	1000	kHz
$t_{CHCL}^{(1)}$	t_{HIGH}	Clock pulse width high	260	-	ns
$t_{CLCH}^{(2)}$	t_{LOW}	Clock pulse width low	500	-	ns
t_{XH1XH2}	t_R	Input signal rise time	(3)	(3)	ns
t_{XL1XL2}	t_F	Input signal fall time	(3)	(3)	ns
t_{DL1DL2}	t_F	SDA (out) fall time	20	120	ns
t_{DXCX}	$t_{SU:DAT}$	Data in set up time	50	-	ns
t_{CLDX}	$t_{HD:DAT}$	Data in hold time	0	-	ns
t_{CLQX}	t_{DH}	Data out hold time	100	-	ns
$t_{CLQV}^{(4)(5)}$	t_{AA}	Clock low to next data valid (access time)	-	450	ns
$t_{CHDX}^{(6)}$	$t_{SU:STA}$	Start condition set up time	250	-	ns
t_{DLCL}	$t_{HD:STA}$	Start condition hold time	250	-	ns
t_{CHDH}	$t_{SU:STO}$	Stop condition set up time	250	-	ns
t_{DHDL}	t_{BUF}	Time between Stop condition and next Start condition	500	-	ns
t_W	t_{WR}	I ² C write time in one page	-	5	ms
		I ² C write time up to 246 bytes	-	150	ms
$t_{NS}^{(7)}$	-	Pulse width ignored (input filter on SCL and SDA)	-	80	ns

1. t_{CHCL} timeout.
2. t_{CLCH} timeout.
3. There is no min. or max. value for the input signal rise and fall times. It is however recommended by the I²C specification that the input signal rise and fall times be less than 120 ns when $f_C < 1$ MHz.
4. To avoid spurious Start and Stop conditions, a minimum delay is placed between SCL=1 and the falling or rising edge of SDA.
5. t_{CLQV} is the time (from the falling edge of SCL) required by the SDA bus line to reach $0.8V_{CC}$ in a compatible way with the I²C specification (which specifies $t_{SU:DAT}(\text{min}) = 100$ ns), assuming that the $R_{bus} \times C_{bus}$ time constant is less than 500 ns (as specified in [Figure 17](#)).
6. For a reStart condition, or following a write cycle.
7. Characterized only, not tested in production.

Figure 16. I²C AC waveforms



MS47532V1

11.1 I²C timing measurement condition

Figure 17 represents the Maximum R_{bus} value versus bus parasitic capacitance (C_{bus}) for an I²C bus at maximum frequency f_C = 400 kHz.

Figure 17. Maximum R_{bus} value with f_C = 400 kHz



Figure 18 represents the Maximum R_{bus} value versus bus parasitic capacitance (C_{bus}) for an I²C bus at maximum frequency f_C = 1 MHz.

Figure 18. Maximum R_{bus} value with f_C = 1 MHz

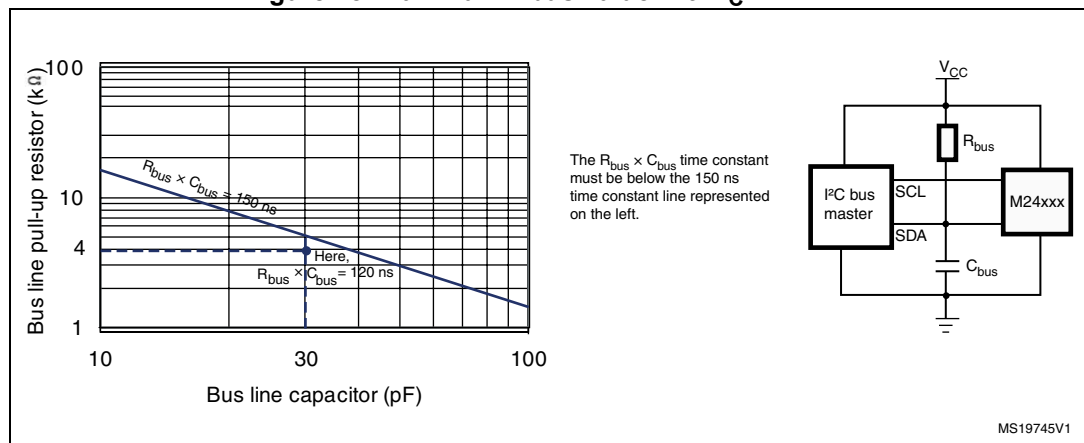

Figure 19. I²C bus protocol



Table 80. Device select code

	Device type identifier ⁽¹⁾				Chip Enable address			RW
	b7	b6	b5	b4	b3	b2	b1	b0
Device select code	1	0	1	0	1	1	0	RW

1. The most significant bit, b7, is sent first.

12 GPO parameters

This section lists the timing of the GPO according to its configuration.

Table 81. GPO timings measurement⁽¹⁾

GPO field		I/F	Condition	Command	Symbol	Typ.	Unit
Session Open	0x1X	I ² C	GPO low when session active	Kill session	CmdSTPtoGPlow *add 100 μs for boot after POR	15*	μs
				Get session		15*	μs
		I ² C	GPO return HZ	I ² C token release sequence	AnswerlbLbtoGPHZ	105	ns
	0x1X	RF	GPO low when session active	NDEF select	CmdEOFtoGPlow	170	μs
		RF	GPO return HZ	Deselect	CmdEOFtoGPHZ	370	μs
WIP	0x2X	I ² C	GPO low when programming	Update Binary	CmdSTPtoGPlow	45	μs
		I ² C			Writing time duration (No time extension)	5	ms
	0x2X	RF	GPO low when programming	Update Binary	CmdEOFtoGPlow	75	μs
		RF			Writing time duration (No time extension)	5	ms
Answer Ready	0x3X	I ² C	GPO low when a command is computed	ReadBinary or UpdateBinary	CmdSTPtoGPlow	55 or 5	μs ms
		I ² C	GPO return HZ on new command	All commands	After NewCmdlbFB or AnswerlbFB	105	ns
Message In Progress	0x3X	RF	GPO low when modifying NDEF	UpdateBinary (Msg Length #0)	CmdEOFtoGPlow	75	μs
		RF	GPO low when modifying NDEF	UpdateBinary	Writing time duration (No time extension)	5	ms
Interrupt	0x4X	I ² C	GPO low after receiving an Interrupt command	SendInterrupt	CmdSTPtoGPlow	50	μs
		I ² C	GPO return HZ	All commands	After NewCmdlbFB or AnswerlbFB	105	ns
	0x4X	RF	GPO low after receiving an Interrupt command	SendInterrupt	CmdEOFtoGPlow	75	μs
		RF			Pulse duration	540	μs

Table 81. GPO timings measurement⁽¹⁾ (continued)

GPO field		I/F	Condition	Command	Symbol	Typ.	Unit
State Control	0x55	I ² C	GPO low when reset	Reset GPO	CmdSTPtoGPlow	40	µs
		I ² C	GPO return HZ when set	Set GPO	CmdSTPtoGPHZ	40	µs
	0x5X	RF	GPO low when reset	Reset GPO	CmdEOFtoGPlow	60	µs
		RF	GPO return HZ when set	Set GPO	CmdEOFtoGPHZ	60	µs
RF Busy	0x6X	RF	GPO low after receiving an RF command	Anticollision command or start of RF disturb (command using another RF protocol)	CmdSOFtoGPlow	6	µs
		RF	GPO return HZ after deselection or RF command in another protocol	Deselect or end of RF disturb (command using another RF protocol)	CmdEOFtoGPHZ	460	µs

1. Characterized only.

13 Write cycle definition

Table 82. Write cycle definition⁽¹⁾

Symbol	Parameter	Test Conditions	Min	Max	Units
Ncycle	Write cycle endurance ⁽²⁾	$T_A \leq 25\text{ °C}, V_{CC(\min)} < V_{CC} < V_{CC(\max)}$	-	1,000,000	Write cycle
		$T_A \leq 85\text{ °C}, V_{CC(\min)} < V_{CC} < V_{CC(\max)}$	-	600,000	

1. A write cycle is calculated per byte, and corresponds to a write to this byte.
2. Write cycle endurance is defined by characterization and qualification.

14 RF electrical parameters

This section summarizes the operating and measurement conditions, and the DC and AC characteristics of the device in RF mode.

The parameters in the DC and AC characteristics tables that follow are derived from tests performed under the Measurement Conditions summarized in the relevant tables. Designers should check that the operating conditions in their circuit match the measurement conditions when relying on the quoted parameters.

Table 83. Default operating conditions

Symbol	Parameter	Min.	Max.	Unit
T _A	Ambient operating temperature for grade 6	-40	85	°C
	Ambient operating temperature for grade 5	-25	85	

Table 84. RF characteristics (1)

Symbol	Parameter	Condition	Min	Typ	Max	Unit
f _C	External RF signal frequency		13.553	13.56	13.567	MHz
H_ISO	Operating field according to ISO	T _A = 0 °C to 50 °C	1500	-	7500	mA/m
H_Extended	Operating field in extended temperature range	T _A = -40 °C to 85 °C	500	-	7500	mA/m
MI _{CARRIER}	100% carrier modulation index	MI=(A-B)/(A+B)	90	-	100	%
t ₁	Pause A length	-	28/f _C	-	40.5/f _C	µs
t ₂	Pause A low time	-	7/f _C	-	t ₁	µs
t ₃	Pause A rise time	-	1.5xt ₄	-	16/f _C	µs
t ₄	Pause A rise time section	-	0	-	6/f _C	µs
t _{MIN CD}	Minimum time from carrier generation to first data	From H-field min	-	-	5	ms
W _t	RF write time (including internal Verify) for one page	-	-	6	-	ms
C _{TUN}	Internal tuning capacitor in SO8 (2)	f _C = 13.56 MHz	22.5	25	27.5	pF
t _{RF_OFF}	RF OFF time	Chip reset	-	-	5	ms

1. All timing characterizations were performed on a reference antenna with the following characteristics:

- External size: 75 mm x 48 mm
- Number of turns: 6
- Width of conductor: 0.6 mm
- Space between two conductors: 0.6 mm
- Value of the tuning capacitor in SO8: 25 pF (M24SR04)
- Value of the coil: 5 µH
- Tuning frequency: 14.2 MHz.

2. Characterized only, at room temperature only, measured at VAC0-VAC1 = 2 V peak to peak at 13.56 MHz.

15 Package information

In order to meet environmental requirements, ST offers these devices in different grades of ECOPACK[®] packages, depending on their level of environmental compliance. ECOPACK[®] specifications, grade definitions and product status are available at: www.st.com.

ECOPACK[®] is an ST trademark.

15.1 SO8N package information

Figure 20. SO8N - 8-lead plastic small outline, 150 mils body width, package outline

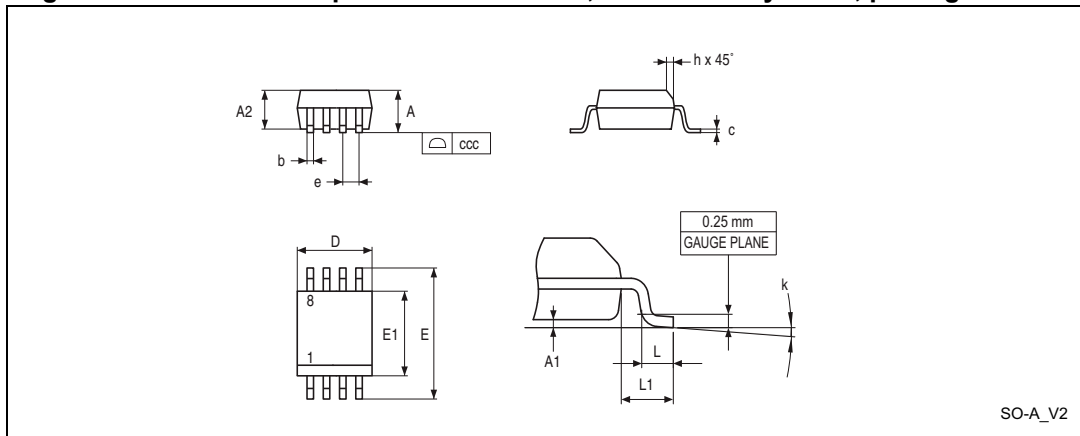

1. Drawing is not to scale.

Table 85. SO8N - 8-lead plastic small outline, 150 mils body width, package data

Symbol	millimeters			inches ⁽¹⁾		
	Min	Typ	Max	Min	Typ	Max
A	-	-	1.750	-	-	0.0689
A1	0.100	-	0.250	0.0039	-	0.0098
A2	1.250	-		0.0492	-	-
b	0.280	-	0.480	0.0110	-	0.0189
c	0.170	-	0.230	0.0067	-	0.0091
D	4.800	4.900	5.000	0.1890	0.1929	0.1969
E	5.800	6.000	6.200	0.2283	0.2362	0.2441
E1	3.800	3.900	4.000	0.1496	0.1535	0.1575
e	-	1.270	-	-	0.0500	-
h	0.250	-	0.500	0.0098	-	0.0197
k	0°	-	8°	0°	-	8°
L	0.400	-	1.270	0.0157	-	0.0500

Table 85. SO8N - 8-lead plastic small outline, 150 mils body width, package data (continued)

Symbol	millimeters			inches ⁽¹⁾		
	Min	Typ	Max	Min	Typ	Max
L1	-	1.040	-	-	0.0409	-
ccc	-	-	0.100	-	-	0.0039

1. Values in inches are converted from mm and rounded to 4 decimal digits.

Figure 21. SO8N - 8-lead plastic small outline, 150 mils body width, package recommended footprint

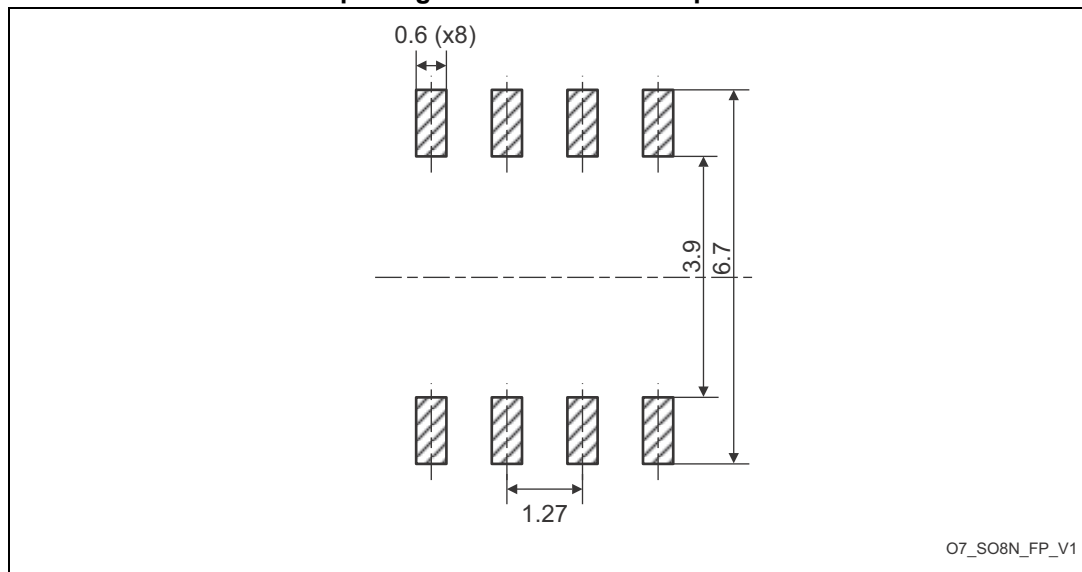

O7_SO8N_FP_V1

15.2 TSSOP8 package information

Figure 22. TSSOP8 – 8-lead thin shrink small outline, 3 x 6.4 mm, 0.65 mm pitch, package outline



1. Drawing is not to scale.

Table 86. TSSOP8 – 8-lead thin shrink small outline, 3 x 6.4 mm, 0.65 mm pitch, package mechanical data

Symbol	millimeters			inches ⁽¹⁾		
	Typ	Min	Max	Typ	Min	Max
A	-	-	1.200	-	-	0.0472
A1	0.050	-	0.150	0.0020	-	0.0059
A2	0.800	1.000	1.050	0.0315	0.0394	0.0413
b	0.190	-	0.300	0.0075	-	0.0118
c	0.090	-	0.200	0.0035	-	0.0079
CP	-	-	0.100	-	-	0.0039
D	2.900	3.000	3.100	0.1142	0.1181	0.1220
e	-	0.650	-	-	0.0256	-
E	6.200	6.400	6.600	0.2441	0.2520	0.2598
E1	4.300	4.400	4.500	0.1693	0.1732	0.1772
L	0.450	0.600	0.750	0.0177	0.02636	0.0295
L1	-	1.000	-	-	0.0394	-
α	0°		8°	0°	-	8°

1. Values in inches are converted from mm and rounded to 4 decimal digits.

Table 87. UDFPN8 - 8- lead, 2 x 3 mm, 0.5 mm pitch ultra thin profile fine pitch dual flat package mechanical data

Symbol	millimeters			inches ⁽¹⁾		
	Min	Typ	Max	Min	Typ	Max
A	0.450	0.550	0.600	0.0177	0.0217	0.0236
A1	0.000	0.020	0.050	0.0000	0.0008	0.0020
b ⁽²⁾	0.200	0.250	0.300	0.0079	0.0098	0.0118
D	1.900	2.000	2.100	0.0748	0.0787	0.0827
D2 (rev MC)	1.200	-	1.600	0.0472	-	0.0630
E	2.900	3.000	3.100	0.1142	0.1181	0.1220
E2 (rev MC)	1.200	-	1.600	0.0472	-	0.0630
e	-	0.500	-	-	0.0197	-
K (rev MC)	0.300	-	-	0.0118	-	-
L	0.300	-	0.500	0.0118	-	0.0197
L1	-	-	0.150	-	-	0.0059
L3	0.300	-	-	0.0118	-	-
aaa	-	-	0.150	-	-	0.0059
bbb	-	-	0.100	-	-	0.0039
ccc	-	-	0.100	-	-	0.0039
ddd	-	-	0.050	-	-	0.0020
eee ⁽³⁾	-	-	0.080	-	-	0.0031

1. Values in inches are converted from mm and rounded to 4 decimal digits.
2. Dimension b applies to plated terminal and is measured between 0.15 and 0.30 mm from the terminal tip.
3. Applied for exposed die paddle and terminals. Exclude embedded part of exposed die paddle from measuring.

16 Ordering information

Table 88. Ordering information scheme for packaged devices

Example:	M24	SR	04-Y	MN	6	T	/2
Device type							
M24 = I ² C interface device							
Device feature							
SR = Short range							
Memory size							
04 = memory size in Kbits							
Voltage range							
Y = 2.7 to 5.5 V G = 2.4 to 5.5 V, only available in grade 5 (-25 to 85 °C)							
Package							
MN = SO8N DW = TSSOP8 MC = UFDFPN8 SG12I = 120 µm ± 15 µm bumped and sawn inkless wafer on 8-inch frame ⁽¹⁾							
Device grade							
5 = industrial: device tested with standard test flow over -25 to 85 °C 6 = industrial: device tested with standard test flow over -40 to 85 °C (No parameter for SG12I)							
Option							
T = Tape and reel packing (No parameter for SG12I)							
Capacitance							
/2 = 25 pF							

1. SG12I is only available for voltage range "G".

Note: *Parts marked as ES or E are not yet qualified and therefore not approved for use in production. ST is not responsible for any consequences resulting from such use. In no event will ST be liable for the customer using any of these engineering samples in production. ST's Quality department must be contacted prior to any decision to use these engineering samples to run a qualification activity.*

17 Revision history

Table 89. Document revision history

Date	Revision	Changes
13-Jun-2013	1	Initial release.
29-Aug-2013	2	Added UDFPN8 drawing <i>on page 1</i> . Edited <i>Section 2.6: RF disable</i> . Updated I _{CC0} parameter in <i>Table 77: I2C DC characteristics</i> and added a note. Added <i>Section 15.3: UDFPN8 package information</i> and UDFPN8 package.
28-Oct-2013	3	Updated the Capacitance value to 25 pF. Removed all "Battery assisted" and "Wire power management" information (conditioned for a future use). Moved <i>GetI2Csession command</i> before <i>Section 5.10.2: KillRFsession command</i> . Added 2 new sections: <i>Section 7.4: I2C token release sequence</i> and <i>Section 7.5: I2C timeout on clock period</i> . Removed "DID field" information from <i>Section 7.9: I2C frame format</i> and from <i>Table 69</i> to <i>Table 71</i> . Updated different values in <i>Table 73: Absolute maximum ratings</i> , <i>Table 74: I2C operating conditions</i> , <i>Table 77: I2C DC characteristics</i> , <i>Table 78: I2C AC characteristics (400 kHz)</i> , <i>Table 79: I2C AC characteristics (1 MHz)</i> , and <i>Table 84: RF characteristics</i> , and removed all "(forecast data)" from the table titles. Moved <i>RF characteristics</i> table before <i>Table 84: RF characteristics</i> , deleted footnote (1) and updated footnote (2). Fully edited.
08-Nov-2013	4	Added a note to <i>Section 7.1: I2C communication protocol</i> below <i>Figure 12: Command and response exchange</i> .
18-Dec-2013	5	Changed the datasheet status from "Preliminary data" to "Production data". Restored the whole content of <i>Table 77: I2C DC characteristics</i> . Updated the capacitor values in <i>Section 2.5.1: Operating supply voltage VCC</i> . Removed bullet (4) from <i>Section 8.6: Reaching the read-only state for an NDEF file</i> . Updated V _{ESD} value in <i>Table 73: Absolute maximum ratings</i> , I _{CC} values in <i>Table 77: I2C DC characteristics</i> , and H_Extended value in <i>Table 84: RF characteristics</i> . Added details to "S(WTX)" bullet in <i>Section 5.4: S-Block format</i> . Added sentences to <i>Section 5.6.8: UpdateBinary command</i> and to <i>Section 5.8.3: DisablePermanentState command</i> . Changed '0x001E' value into '0x001F' in <i>Table 56: StateControl command format</i> . Updated values in <i>Table 61: ATS response</i> . Added Note (4) to <i>Figure 10: Changing the read access right to an NDEF file</i> and <i>Figure 11: Changing the write access right to an NDEF file</i> .

Table 89. Document revision history (continued)

Date	Revision	Changes
26-Feb-2014	6	<p>Updated Figure 5: GPO configured as I2C answer ready (GPO field = 0xX3) and Figure 8: GPO configured as State Control (GPO field = 0xX5 or 0x5X). Added I²C text to the Note below Table 22: S-Block detailed format. Edited the third paragraph of Section 5.8.1: ExtendedReadBinary command. Added Section 5.8.4: UpdateFileType command and Section 8.8: Changing a File type Procedure. Updated bullet 3 in Section 7.9: I²C frame format, and the Payload row of Table 70: I2C host to M24SR04. Updated bullet 2 in Section 7.11: Close the I²C session. Edited V_{IO} row and removed V_{ESD} (machine model) row from Table 73: Absolute maximum ratings. Updated I_{CC} rows and added a Note to Table 77: I2C DC characteristics. Updated Figure 20: SO8N - 8-lead plastic small outline, 150 mils body width, package outline. Fixed a typo in Figure 23: UDFPN8 - 8-lead, 2 x 3 mm, 0.5 mm pitch ultra thin profile fine pitch dual flat package outline title: UDFPN8 changed into UDFPN8.</p>
11-Jun-2014	7	<p>Added data for automotive grade in Table 6: Field list and Table 72: UID format Added WDFPN8 package for automotive grade under qualification Added Figure 24: WDFPN8 (MLP8) 8-lead, 2 x 3 mm, 0.5 mm pitch very thin fine pitch dual flat package outline Added WDFPN8 package for automotive grade under qualification Added Table 88: WDFPN8 8-lead thin fine pitch dual flat package no lead mechanical data Added MF = WDFPN8 inside Table 88: Ordering information scheme for packaged devices Inserted byte <04> between A4 and 00 inside Figure 14: NDEF tag Application Select command</p>
20-Nov-2014	8	<p>Added: – New Root Part Number on cover page – single supply voltage for I2C for grade G and note (1) Updated: – Figure 14 – Figure 73, Figure 74, Figure 77, Figure 78, Figure 83, Figure 88</p>
20-Aug-2015	9	<p>Added – Figure 21: SO8N - 8-lead plastic small outline, 150 mils body width, package recommended footprint Updated – Section 15: Package information – Table 73: Absolute maximum ratings – Table 74: I2C operating conditions – Table 78: I2C AC characteristics (400 kHz) – Table 88: Ordering information scheme for packaged devices</p>

Table 89. Document revision history (continued)

Date	Revision	Changes
04-Mar-2016	10	Updated: – Features – Section 2.7.6: State Control configuration (GPO field = 0xX5 or 0x5X) Added: – Table 7: Details about I2C watchdog – Table 82: Write cycle definition
27-Apr-2016	11	Updated: – Features – Table 73: Absolute maximum ratings – Table 82: Write cycle definition Added: – Section 13: Write cycle definition
14-Oct-2016	12	Updated: – Section 3.2.2: Changing the read access right to NDEF files – Section 3.2.3: Changing the write access right to NDEF files – Section 5.6.5: NDEF Select command – Section 5.8.4: UpdateFileType command – Section 5.8.5: SendInterrupt command – Section 8.2: Reading of an NDEF message – Section 8.5: Unlocking an NDEF file – Section 8.6: Reaching the read-only state for an NDEF file – Section 16: Ordering information Added: – Section 8.9: Updating a NDEF file
18-Nov-2016	13	Updated: – Table 35: R-APDU of the ReadBinary command – Table 47: R-APDU of the ExtendedReadBinary command – Table 88: Ordering information scheme for packaged devices
07-Feb-2017	14	Added: – Note 4, on Figure 23.: UFDFPN8 - 8-lead, 2 x 3 mm, 0.5 mm pitch ultra thin profile fine pitch dual flat package outline Updated: – Table 88: Ordering information scheme for packaged devices

Table 89. Document revision history (continued)

Date	Revision	Changes
08-Feb-2017	15	Package SB12I replaced with SG12I. Updated: – Table 73: Absolute maximum ratings – Table 88: Ordering information scheme for packaged devices
12-Sep-2017	16	Updated: – Features – Table 6: Field list – Table 20: R-Block detailed format – Table 72: UID format – Table 74: I2C operating conditions – Table 78: I2C AC characteristics (400 kHz) – Table 86: TSSOP8 – 8-lead thin shrink small outline, 3 x 6.4 mm, 0.65 mm pitch, package mechanical data – Table 88: Ordering information scheme for packaged devices – Figure 10: Changing the read access right to an NDEF file – Figure 11: Changing the write access right to an NDEF file – Figure 15: AC test measurement I/O waveform – Figure 16: I2C AC waveforms – Figure 19: I2C bus protocol – Figure 22: TSSOP8 – 8-lead thin shrink small outline, 3 x 6.4 mm, 0.65 mm pitch, package outline – Section 16: Ordering information Deleted: – Section 15.4: WFDFPN8 package information – Figure 24: WFDFPN8 (MLP8) 8-lead, 2 x 3 mm, 0.5 mm pitch very thin fine pitch dual flat package outline – Table 88: WFDFPN8 8-lead thin fine pitch dual flat package no lead mechanical data

IMPORTANT NOTICE – PLEASE READ CAREFULLY

STMicroelectronics NV and its subsidiaries ("ST") reserve the right to make changes, corrections, enhancements, modifications, and improvements to ST products and/or to this document at any time without notice. Purchasers should obtain the latest relevant information on ST products before placing orders. ST products are sold pursuant to ST's terms and conditions of sale in place at the time of order acknowledgement.

Purchasers are solely responsible for the choice, selection, and use of ST products and ST assumes no liability for application assistance or the design of Purchasers' products.

No license, express or implied, to any intellectual property right is granted by ST herein.

Resale of ST products with provisions different from the information set forth herein shall void any warranty granted by ST for such product.

ST and the ST logo are trademarks of ST. All other product or service names are the property of their respective owners.

Information in this document supersedes and replaces information previously supplied in any prior versions of this document.

© 2017 STMicroelectronics – All rights reserved



Данный компонент на территории Российской Федерации

Вы можете приобрести в компании MosChip.

Для оперативного оформления запроса Вам необходимо перейти по данной ссылке:

<http://moschip.ru/get-element>

Вы можете разместить у нас заказ для любого Вашего проекта, будь то серийное производство или разработка единичного прибора.

В нашем ассортименте представлены ведущие мировые производители активных и пассивных электронных компонентов.

Нашей специализацией является поставка электронной компонентной базы двойного назначения, продукции таких производителей как XILINX, Intel (ex.ALTERA), Vicor, Microchip, Texas Instruments, Analog Devices, Mini-Circuits, Amphenol, Glenair.

Сотрудничество с глобальными дистрибьюторами электронных компонентов, предоставляет возможность заказывать и получать с международных складов практически любой перечень компонентов в оптимальные для Вас сроки.

На всех этапах разработки и производства наши партнеры могут получить квалифицированную поддержку опытных инженеров.

Система менеджмента качества компании отвечает требованиям в соответствии с ГОСТ Р ИСО 9001, ГОСТ РВ 0015-002 и ЭС РД 009

Офис по работе с юридическими лицами:

105318, г.Москва, ул.Щербаковская д.3, офис 1107, 1118, ДЦ «Щербаковский»

Телефон: +7 495 668-12-70 (многоканальный)

Факс: +7 495 668-12-70 (доб.304)

E-mail: info@moschip.ru

Skype отдела продаж:

moschip.ru

moschip.ru_4

moschip.ru_6

moschip.ru_9