

## FEATURES

- Offset Voltage – Prime Grade: 60 $\mu$ V Max
- Offset Voltage – Low Cost Grade (Including Surface Mount Dual/Quad): 75 $\mu$ V Max
- Offset Voltage Drift: 0.5 $\mu$ V/ $^{\circ}$ C Max
- Input Bias Current: 250pA Max
- 0.1Hz to 10Hz Noise: 0.3 $\mu$ V<sub>P-P</sub>, 2.2pA<sub>P-P</sub>
- Supply Current per Amplifier: 400 $\mu$ A Max
- CMRR: 120dB Min
- Voltage Gain: 1 Million Min
- Guaranteed Specs with  $\pm$ 1.0V Supplies
- Guaranteed Matching Specifications
- SO-8 Package – Standard Pinout
- LT1114 in Narrow Surface Mount Package

## APPLICATIONS

- Picoampere/Microvolt Instrumentation
- Two and Three Op Amp Instrumentation Amplifiers
- Thermocouple and Bridge Amplifiers
- Low Frequency Active Filters
- Photo Current Amplifiers
- Battery-Powered Systems

## DESCRIPTION

The LT<sup>®</sup>1112 dual and LT1114 quad op amps achieve a new standard in combining low cost and outstanding precision specifications.

The performance of the selected prime grades matches or exceeds competitive devices. In the design of the LT1112/LT1114 however, particular emphasis has been placed on optimizing performance in the low cost plastic and SO packages. For example, the 75 $\mu$ V maximum offset voltage in these low cost packages is the lowest on any dual or quad non-chopper op amp.

The LT1112/LT1114 also provide a full set of matching specifications, facilitating their use in such matching dependent applications as two and three op amp instrumentation amplifiers.

Another set of specifications is furnished at  $\pm$ 1V supplies. This, combined with the low 320 $\mu$ A supply current per amplifier, allows the LT1112/LT1114 to be powered by two nearly discharged AA cells.

LT, LT, LTC and LTM are registered trademarks of Linear Technology Corporation. Protected by U.S. Patents 4,575,685; 4,775,884 and 4,837,496

## TYPICAL APPLICATION

### Dual Output, Buffered Reference (On Single 3V Supply)

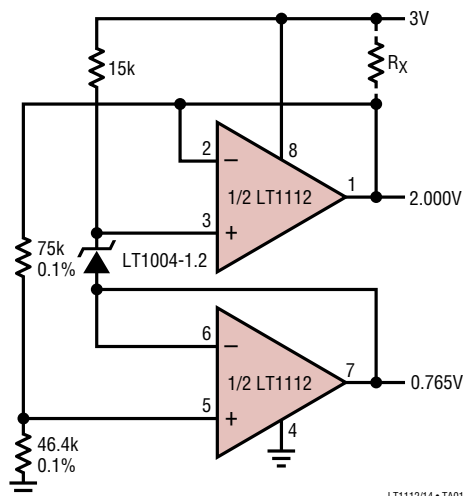

TOTAL SUPPLY CURRENT = 700 $\mu$ A  
 2V REFERENCE: SOURCES 1.7mA, SINKS 5mA  
 OPTIONAL  $R_X = 300\Omega$  INCREASES SOURCE CURRENT TO 5mA  
 0.765V REFERENCE: SOURCES 5mA, SINKS 0.5mA  
 TEMPERATURE COEFFICIENT LIMITED BY REFERENCE = 20ppm/ $^{\circ}$ C  
 MINIMUM SUPPLY = 2.7V

### Distribution of Input Offset Voltage (In All Packages)

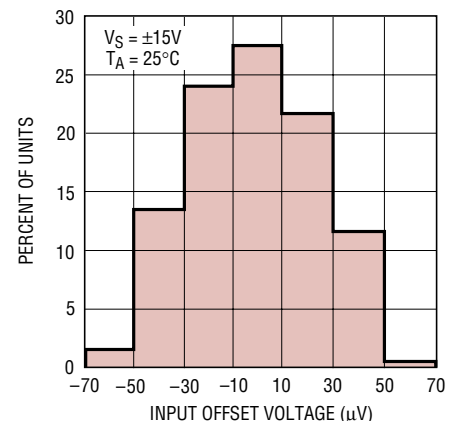

LT1112/14 • TA02

## ABSOLUTE MAXIMUM RATINGS (Note 1)

Supply Voltage .....  $\pm 20V$   
 Differential Input Current (Note 2) .....  $\pm 10mA$   
 Input Voltage (Equal to Supply Voltage) .....  $\pm 20V$   
 Output Short-Circuit Duration ..... Indefinite  
 Storage Temperature Range .....  $-65^{\circ}C$  to  $150^{\circ}C$   
 Lead Temperature (Soldering, 10 sec) .....  $300^{\circ}C$   
 Operating Temperature Range (Note 11)

Specified Temperature Range (Note 12)

LT1112AM/LT1112M  
 LT1114AM/LT1114M (**OBSOLETE**)...  $-55^{\circ}C$  to  $125^{\circ}C$   
 LT1112AC/LT1112C/LT1112S8  
 LT1114AC/LT1114C/LT1114S .....  $-40^{\circ}C$  to  $85^{\circ}C$   
 LT1112I/LT1114I .....  $-40^{\circ}C$  to  $85^{\circ}C$   
 LT1112MPS8 .....  $-55^{\circ}C$  to  $125^{\circ}C$

LT1112AM/LT1112M  
 LT1114AM/LT1114M (**OBSOLETE**)...  $-55^{\circ}C$  to  $125^{\circ}C$   
 LT1112AC/LT1112C/LT1112S8  
 LT1114AC/LT1114C/LT1114S .....  $-40^{\circ}C$  to  $85^{\circ}C$   
 LT1112I/LT1114I .....  $-40^{\circ}C$  to  $85^{\circ}C$   
 LT1112MPS8 .....  $-55^{\circ}C$  to  $125^{\circ}C$

## PACKAGE/ORDER INFORMATION

<p>N8 PACKAGE 8-LEAD PDIP</p> <p><math>T_{JMAX} = 150^{\circ}C</math>, <math>\theta_{JA} = 130^{\circ}C/W</math></p>	<p>ORDER PART NUMBER</p> <p>LT1112ACN8 LT1112CN8 LT1112IN8</p>	<p>S8 PACKAGE 8-LEAD PLASTIC SO</p> <p><math>T_{JMAX} = 150^{\circ}C</math>, <math>\theta_{JA} = 190^{\circ}C/W</math></p>	<p>ORDER PART NUMBER</p> <p>LT1112S8 LT1112IS8 LT1112MPS8</p> <p>S8 PART MARKING</p> <p>1112 1112I 1112MP</p>
<p><b>OBSOLETE PACKAGE</b> Consider the N8 Package for Alternate Source</p> <p>J8 PACKAGE 8-LEAD CERDIP <math>T_{JMAX} = 160^{\circ}C</math>, <math>\theta_{JA} = 100^{\circ}C/W</math></p> <p>LT1112AMJ8 LT1112MJ8</p>			
<p>N PACKAGE 14-LEAD PDIP</p> <p><math>T_{JMAX} = 150^{\circ}C</math>, <math>\theta_{JA} = 110^{\circ}C/W</math></p> <p>J PACKAGE 14-LEAD CERDIP <math>T_{JMAX} = 160^{\circ}C</math>, <math>\theta_{JA} = 80^{\circ}C/W</math> (J)</p> <p><b>OBSOLETE PACKAGE</b> Consider the N Package for Alternate Source</p> <p>LT1114AMJ LT1114MJ</p>	<p>ORDER PART NUMBER</p> <p>LT1114ACN LT1114CN LT1114IN</p>	<p>S PACKAGE 16-LEAD PLASTIC SO (NARROW)</p> <p><math>T_{JMAX} = 150^{\circ}C</math>, <math>\theta_{JA} = 150^{\circ}C/W</math></p>	<p>ORDER PART NUMBER</p> <p>LT1114S LT1114IS</p>

Consult LTC Marketing for parts specified with wider operating temperature ranges.

**ELECTRICAL CHARACTERISTICS**  $V_S = \pm 15V$ ,  $V_{CM} = 0V$ ,  $T_A = 25^\circ C$ , unless otherwise noted.

SYMBOL	PARAMETER	CONDITIONS (Note 3)	LT1112AM/AC LT1114AM/AC			LT1112M/C/I LT1114M/C/I			UNITS
			MIN	TYP	MAX	MIN	TYP	MAX	
$V_{OS}$	Input Offset Voltage	$V_S = \pm 1.0V$		20 40	60 110		25 45	75 130	$\mu V$ $\mu V$
$\frac{\Delta V_{OS}}{\Delta Time}$	Long Term Input Offset Voltage Stability			0.3			0.3		$\mu V/Mo$
$I_{OS}$	Input Offset Current	LT1114S/LT1114IS		50	180		60 75	230 330	pA pA
$I_B$	Input Bias Current	LT1114S/LT1114IS		$\pm 70$	$\pm 250$		$\pm 80$ $\pm 100$	$\pm 280$ $\pm 450$	pA pA
$e_n$	Input Noise Voltage	0.1Hz to 10Hz (Note 10)		0.3	0.9		0.3	0.9	$\mu V_{P-P}$
	Input Noise Voltage Density	$f_0 = 10Hz$ (Note 10) $f_0 = 1000Hz$ (Note 10)		16 14	28 18		16 14	28 18	$nV/\sqrt{Hz}$ $nV/\sqrt{Hz}$
$i_n$	Input Noise Current	0.1Hz to 10Hz		2.2			2.2		$pA_{P-P}$
	Input Noise Current Density	$f_0 = 10Hz$ $f_0 = 1000Hz$		0.030 0.008			0.030 0.008		$pA/\sqrt{Hz}$ $pA/\sqrt{Hz}$
$V_{CM}$	Input Voltage Range		$\pm 13.5$	$\pm 14.3$		$\pm 13.5$	$\pm 14.3$		V
CMRR	Common Mode Rejection Ratio	$V_{CM} = \pm 13.5V$	120	136		115	136		dB
PSRR	Power Supply Rejection Ratio	$V_S = \pm 1.0V$ to $\pm 20V$	116	126		114	126		dB
	Minimum Supply Voltage	(Note 5)	$\pm 1.0$			$\pm 1.0$			V
$R_{IN}$	Input Resistance Differential Mode Common Mode	(Note 4)	20	50 800		15	40 700		M $\Omega$ G $\Omega$
$A_{VOL}$	Large-Signal Voltage Gain	$V_0 = \pm 12V$ , $R_L = 10k\Omega$ $V_0 = \pm 10V$ , $R_L = 2k\Omega$	1000 800	5000 1500		800 600	5000 1300		V/mV V/mV
$V_{OUT}$	Output Voltage Swing	$R_L = 10k\Omega$ $R_L = 2k\Omega$	$\pm 13.0$ $\pm 11.0$	$\pm 14.0$ $\pm 12.4$		$\pm 13.0$ $\pm 11.0$	$\pm 14.0$ $\pm 12.4$		V V
SR	Slew Rate		0.16	0.30		0.16	0.30		V/ $\mu s$
GBW	Gain-Bandwidth Product	$f_0 = 10kHz$	450	750		450	750		kHz
$I_S$	Supply Current per Amplifier	$V_S = \pm 1.0V$		350 320	400 370		350 320	450 420	$\mu A$ $\mu A$
	Channel Separation	$f_0 = 10Hz$		150			150		dB
$\Delta V_{OS}$	Offset Voltage Match	(Note 6)		35	100		40	130	$\mu V$
$\Delta I_B^+$	Noninverting Bias Current Match (Notes 6, 7)	LT1114S/LT1114IS		100	450		100 120	500 680	pA pA
$\Delta CMRR$	Common Mode Rejection Match	(Notes 6, 8)	117	136		113	136		dB
$\Delta PSRR$	Power Supply Rejection Match	(Notes 6, 8)	114	130		112	130		dB

**ELECTRICAL CHARACTERISTICS** The ● denotes the specifications which apply over the full operating temperature range of  $-55^{\circ}\text{C} \leq T_A \leq 125^{\circ}\text{C}$ , otherwise specifications are at  $T_A = 25^{\circ}\text{C}$ .  $V_S = \pm 15\text{V}$ , unless otherwise noted.

SYMBOL	PARAMETER	CONDITIONS (Note 3)	LT1112AMJ8 LT1114AMJ			LT1112MJ8/MPS8 LT1114MJ			UNITS
			MIN	TYP	MAX	MIN	TYP	MAX	
$V_{OS}$	Input Offset Voltage	LT1112MPS8 $V_S = \pm 1.2\text{V}$	●	35	120	45	150	$\mu\text{V}$	
			●	60	220	70	260	$\mu\text{V}$	
$\frac{\Delta V_{OS}}{\Delta \text{Temp}}$	Average Input Offset Voltage Drift	(Note 9) LT1112MPS8	●	0.15	0.5	0.20	0.75	$\mu\text{V}/^{\circ}\text{C}$	
			●			0.4	1.3	$\mu\text{V}/^{\circ}\text{C}$	
$I_{OS}$	Input Offset Current		●	80	400	100	500	pA	
$I_B$	Input Bias Current		●	$\pm 150$	$\pm 600$	$\pm 170$	$\pm 700$	pA	
$V_{CM}$	Input Voltage Range		●	$\pm 13.5$	$\pm 14.1$	$\pm 13.5$	$\pm 14.1$	V	
CMRR	Common Mode Rejection Ratio	$V_{CM} = \pm 13.5\text{V}$	●	116	130	111	130	dB	
PSRR	Power Supply Rejection Ratio	$V_S = \pm 1.2\text{V}$ to $\pm 20\text{V}$	●	112	124	110	124	dB	
$A_{VOL}$	Large-Signal Voltage Gain	$V_O = \pm 12\text{V}$ , $R_L = 10\text{k}\Omega$ $V_O = \pm 10\text{V}$ , $R_L = 2\text{k}\Omega$	●	500	2500	400	2500	V/mV	
			●	200	600	170	500	V/mV	
$V_{OUT}$	Output Voltage Swing	$R_L = 10\text{k}\Omega$	●	$\pm 13.0$	$\pm 13.85$	$\pm 13.0$	$\pm 13.85$	V	
SR	Slew Rate		●	0.12	0.22	0.12	0.22	V/ $\mu\text{s}$	
$I_S$	Supply Current per Amplifier		●	380	460	380	530	$\mu\text{A}$	
$\Delta V_{OS}$	Offset Voltage Match (Note 6)	LT1112MPS8	●	55	200	70	240	$\mu\text{V}$	
			●			70	270	$\mu\text{V}$	
	Offset Voltage Match Drift (Notes 6, 9)	LT1112MPS8	●	0.2	0.7	0.3	1.0	$\mu\text{V}/^{\circ}\text{C}$	
			●			0.5	1.9	$\mu\text{V}/^{\circ}\text{C}$	
$\Delta I_B^+$	Noninverting Bias Current Match	(Notes 6, 7)	●	150	750	170	850	pA	
$\Delta \text{CMRR}$	Common Mode Rejection Ratio	(Notes 6, 8)	●	112	130	106	130	dB	
$\Delta \text{PSRR}$	Power Supply Rejection Ratio	(Notes 6, 8)	●	109	126	106	126	dB	

The ● denotes the specifications which apply over the full operating temperature range of  $0^{\circ}\text{C} \leq T_A \leq 70^{\circ}\text{C}$ , otherwise specifications are at  $T_A = 25^{\circ}\text{C}$ .  $V_S = \pm 15\text{V}$ , unless otherwise noted.

SYMBOL	PARAMETER	CONDITIONS (Note 3)	LT1112ACN8 LT1114ACN			LT1112CN8/S8/IS8 LT1114CN/S/IS			UNITS
			MIN	TYP	MAX	MIN	TYP	MAX	
$V_{OS}$	Input Offset Voltage	LT1112CN8 LT1112S8, LT1114CN/S $V_S = \pm 1.2\text{V}$	●	27	100	30	125	$\mu\text{V}$	
			●	35	125	45	150	$\mu\text{V}$	
			●	50	175	65	210	$\mu\text{V}$	
$\frac{\Delta V_{OS}}{\Delta \text{Temp}}$	Average Input Offset Voltage Drift (Note 9)	LT1112CN8 LT1112S8, LT1114CN/S	●	0.15	0.5	0.2	0.75	$\mu\text{V}/^{\circ}\text{C}$	
			●	0.3	1.1	0.4	1.3	$\mu\text{V}/^{\circ}\text{C}$	
$I_{OS}$	Input Offset Current	LT1114S	●	60	220	70	290	pA	
			●			90	420	pA	
$I_B$	Input Bias Current	LT1114S	●	$\pm 80$	$\pm 300$	$\pm 90$	$\pm 350$	pA	
			●			$\pm 115$	$\pm 550$	pA	
$V_{CM}$	Input Voltage Range		●	$\pm 13.5$	$\pm 14.2$	$\pm 13.5$	$\pm 14.2$	V	
CMRR	Common Mode Rejection Ratio	$V_{CM} = \pm 13.5\text{V}$	●	118	133	113	133	dB	
PSRR	Power Supply Rejection Ratio	$V_S = \pm 1.2\text{V}$ to $\pm 20\text{V}$	●	114	125	112	125	dB	
$A_{VOL}$	Large-Signal Voltage Gain	$V_O = \pm 12\text{V}$ , $R_L = 10\text{k}\Omega$ $V_O = \pm 10\text{V}$ , $R_L = 2\text{k}\Omega$	●	800	4000	650	4000	V/mV	
			●	500	1300	400	1000	V/mV	
$V_{OUT}$	Output Voltage Swing	$R_L = 10\text{k}\Omega$	●	$\pm 13.0$	$\pm 13.9$	$\pm 13.0$	$\pm 13.9$	V	
SR	Slew Rate		●	0.14	0.27	0.14	0.27	V/ $\mu\text{s}$	

**ELECTRICAL CHARACTERISTICS** The ● denotes the specifications which apply over the full operating temperature range of  $0^{\circ}\text{C} \leq T_A \leq 70^{\circ}\text{C}$ , otherwise specifications are at  $T_A = 25^{\circ}\text{C}$ .  $V_S = \pm 15\text{V}$ , unless otherwise noted.

SYMBOL	PARAMETER	CONDITIONS (Note 3)	LT1112ACN8 LT1114ACN			LT1112CN8/S8/IS8 LT1114CN/S/IS			UNITS
			MIN	TYP	MAX	MIN	TYP	MAX	
$I_S$	Supply Current per Amplifier		●	370	440	370	500	$\mu\text{A}$	
$\Delta V_{OS}$	Offset Voltage Match (Note 6)	LT1112CN8	●	45	170	55	210	$\mu\text{V}$	
		LT1112S8, LT1114CN/S	●	55	220	70	270	$\mu\text{V}$	
	Offset Voltage Match Drift (Notes 6, 9)	LT1112N8	●	0.2	0.7	0.3	1.0	$\mu\text{V}/^{\circ}\text{C}$	
		LT1112S8, LT1114CN/S	●	0.4	1.6	0.5	1.9	$\mu\text{V}/^{\circ}\text{C}$	
$\Delta I_B^+$	Noninverting Bias Current Match (Notes 6, 7)	LT1114S	●	120	530	135	620	$\text{pA}$	
$\Delta\text{CMRR}$	Common Mode Rejection Ratio	(Notes 6, 8)	●	114	134	109	134	$\text{dB}$	
$\Delta\text{PSRR}$	Power Supply Rejection Ratio	(Notes 6, 8)	●	110	128	108	128	$\text{dB}$	

The ● denotes the specifications which apply over the full operating temperature range of  $-40^{\circ}\text{C} \leq T_A \leq 85^{\circ}\text{C}$ , otherwise specifications are at  $T_A = 25^{\circ}\text{C}$ .  $V_S = \pm 15\text{V}$ , unless otherwise noted. (Note 12)

SYMBOL	PARAMETER	CONDITIONS (Note 3)	LT1112ACN8 LT1114ACN			LT1112CN8/IN8/S8/IS8 LT1114CN/S/IS			UNITS
			MIN	TYP	MAX	MIN	TYP	MAX	
$V_{OS}$	Input Offset Voltage	LT1112CN8/IN8	●	30	110	35	135	$\mu\text{V}$	
		LT1112S8/IS8, LT1114CN/S/IS	●	40	135	45	160	$\mu\text{V}$	
		$V_S = \pm 1.2\text{V}$	●	55	200	60	240	$\mu\text{V}$	
$\frac{\Delta V_{OS}}{\Delta\text{Temp}}$	Average Input Offset Voltage Drift	LT1112CN8/IN8	●	0.15	0.50	0.20	0.75	$\mu\text{V}/^{\circ}\text{C}$	
		LT1112S8/IS8, LT1114CN/S/IS	●	0.30	1.10	0.40	1.30	$\mu\text{V}/^{\circ}\text{C}$	
$I_{OS}$	Input Offset Current	LT1114S/IS	●	70	330	85	400	$\text{pA}$	
			●			110	600	$\text{pA}$	
$I_B$	Input Bias Current	LT1114S/IS	●	$\pm 110$	$\pm 500$	$\pm 120$	$\pm 550$	$\text{pA}$	
			●			$\pm 150$	$\pm 800$	$\text{pA}$	
$V_{CM}$	Input Voltage Range		●	$\pm 13.5$	$\pm 14.1$	$\pm 13.5$	$\pm 14.1$	$\text{V}$	
$\text{CMRR}$	Common Mode Rejection Ratio	$V_{CM} = \pm 13.5\text{V}$	●	117	132	112	132	$\text{dB}$	
$\text{PSRR}$	Power Supply Rejection Ratio	$V_S = \pm 1.2\text{V}$ to $\pm 20\text{V}$	●	113	125	111	125	$\text{dB}$	
$A_{VOL}$	Large-Signal Voltage Gain	$V_O = \pm 12\text{V}$ , $R_L = 10\text{k}\Omega$	●	700	3300	600	3300	$\text{V/mV}$	
		$V_O = \pm 10\text{V}$ , $R_L = 2\text{k}\Omega$	●	400	1100	300	900	$\text{V/mV}$	
$V_{OUT}$	Output Voltage Swing	$R_L = 10\text{k}\Omega$	●	$\pm 13.0$	$\pm 13.85$	$\pm 13.0$	$\pm 13.85$	$\text{V}$	
$\text{SR}$	Slew Rate		●	0.13	0.24	0.13	0.24	$\text{V}/\mu\text{s}$	
$I_S$	Supply Current per Amplifier		●	370	450	370	510	$\mu\text{A}$	
$\Delta V_{OS}$	Offset Voltage Match (Note 6)	LT1112CN8/IN8	●	50	180	60	225	$\mu\text{V}$	
		LT1112S8/IS8, LT1114CN/S/IS	●	60	230	70	270	$\mu\text{V}$	
	Offset Voltage Match Drift (Notes 6)	LT1112CN8/IN8	●	0.2	0.7	0.3	1.0	$\mu\text{V}/^{\circ}\text{C}$	
		LT1112S8/IS8, LT1114CN/S/IS	●	0.4	1.6	0.5	1.9	$\mu\text{V}/^{\circ}\text{C}$	
$\Delta I_B^+$	Noninverting Bias Current Match (Notes 6, 7)	LT1114S/IS	●	140	660	155	770	$\text{pA}$	
			●			190	1300	$\text{pA}$	
$\Delta\text{CMRR}$	Common Mode Rejection Ratio	(Notes 6, 8)	●	113	133	109	133	$\text{dB}$	
$\Delta\text{PSRR}$	Power Supply Rejection Ratio	(Notes 6, 8)	●	110	127	107	127	$\text{dB}$	

**Note 1:** Stresses beyond those listed under Absolute Maximum Ratings may cause permanent damage to the device. Exposure to any Absolute Maximum Rating condition for extended periods may affect device reliability and lifetime.

**Note 2:** Differential input voltages greater than 1V will cause excessive current to flow through the input protection diodes unless limiting resistance is used.

**Note 3:** Typical parameters are defined as the 60% yield of parameter distributions of individual amplifiers; i.e., out of 100 LT1114s (or 100 LT1112s) typically 240 op amps (or 120) will be better than the indicated specification.

**Note 4:** This parameter is guaranteed by design and is not tested.

## ELECTRICAL CHARACTERISTICS

**Note 5:** Offset voltage, supply current and power supply rejection ratio are measured at the minimum supply voltage.

**Note 6:** Matching parameters are the difference between amplifiers A and D and between B and C on the LT1114; between the two amplifiers on the LT1112.

**Note 7:** This parameter is the difference between two noninverting input bias currents.

**Note 8:**  $\Delta\text{CMRR}$  and  $\Delta\text{PSRR}$  are defined as follows: (1) CMRR and PSRR are measured in  $\mu\text{V}/\text{V}$  on the individual amplifiers. (2) The difference is calculated between the matching sides in  $\mu\text{V}/\text{V}$ . (3) The result is converted to dB.

**Note 9:** This parameter is not 100% tested.

**Note 10:** These parameters are not tested. More than 99% of the op amps tested during product characterization have passed the maximum limits. 100% passed at 1kHz.

**Note 11:** The LT1112AC/LT1112C/LT1112S8/LT1112I and LT1114AC/LT1114C/LT1114S/LT1114I are guaranteed functional over the temperature range of  $-40^\circ\text{C}$  to  $85^\circ\text{C}$ .

**Note 12:** The LT1112AC/LT1112C/LT1112S8/LT1114AC/LT1114C/LT1114S are guaranteed to meet specified performance from  $0^\circ\text{C}$  to  $70^\circ\text{C}$  and are designed, characterized and expected to meet specified performance from  $-40^\circ\text{C}$  to  $85^\circ\text{C}$ , but are not tested or QA sampled at these temperatures. The LT1112I/LT1114I are guaranteed to meet specified performance from  $-40^\circ\text{C}$  to  $85^\circ\text{C}$ .

## TYPICAL PERFORMANCE CHARACTERISTICS

**Input Bias and Offset Current, Noninverting Bias Current Match vs Temperature**



LT1112/14 • TPC01

**Input Bias Current Over Common Mode Range**

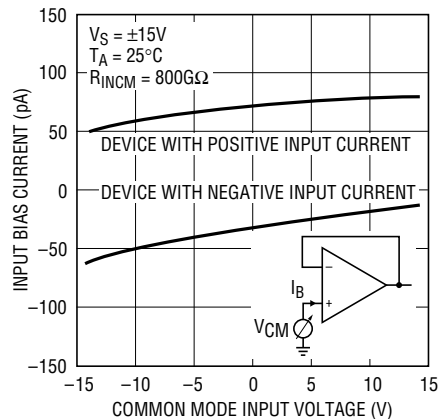

LT1112/14 • TPC02

**Distribution of Input Bias Current (In All Packages Except LT1114S)**



LT1112/14 • TPC03

**Drift with Temperature LT1112N8/J8, LT1114J**

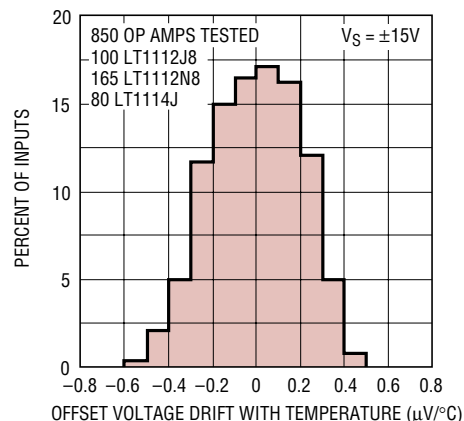

LT1112/14 • TPC04

**Drift with Temperature LT1112S8, LT1114N/S**

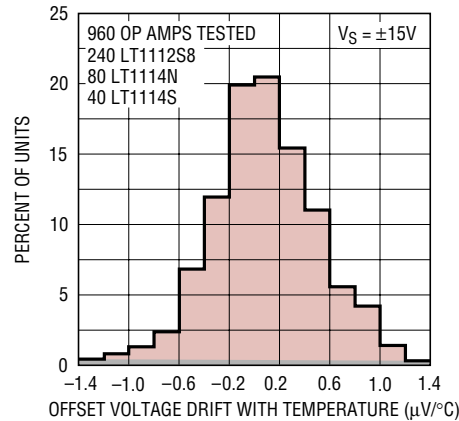

LT1112/14 • TPC05

**Distribution of Offset Voltage at V\_S = ±1.0V (In All Packages)**

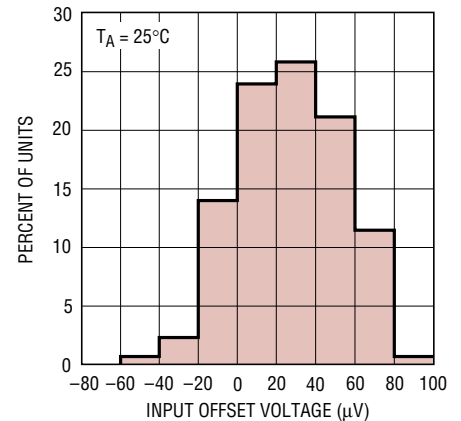

LT1112/14 • TPC06

# TYPICAL PERFORMANCE CHARACTERISTICS

**Distribution of Offset Voltage Match**

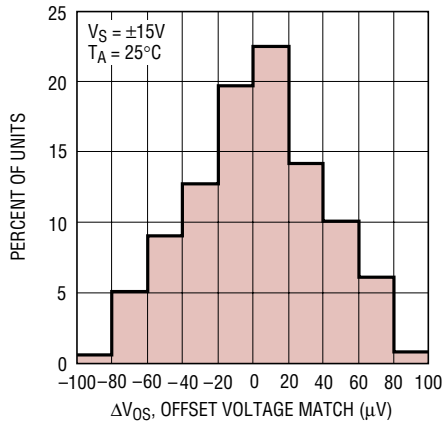

LT1112/14 • TPC07

**Distribution of Offset Voltage Match Drift (LT1112J8, LT1112N8, LT1114J Packages)**

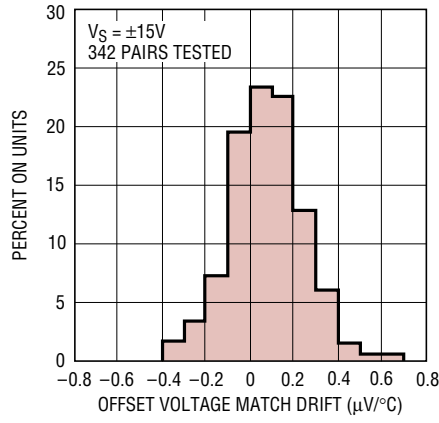

LT1112/14 • TPC08

**Distribution of Offset Voltage Match Drift (LT1112S8, LT1114N, LT1114S Packages)**

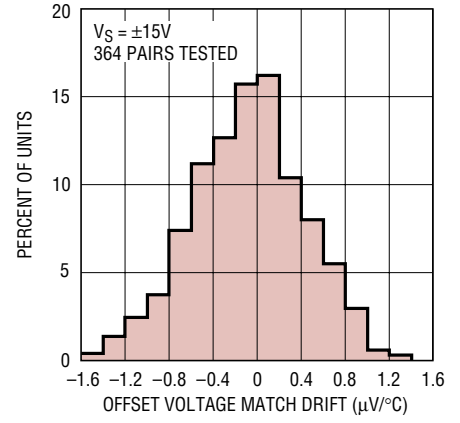

LT1112/14 • TPC09

**Noise Spectrum**

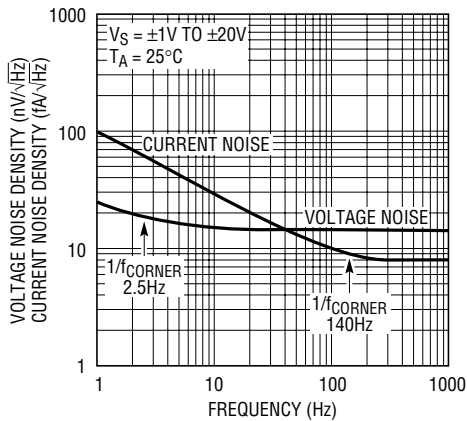

LT1112/14 • TPC10

**0.1Hz to 10Hz Noise**

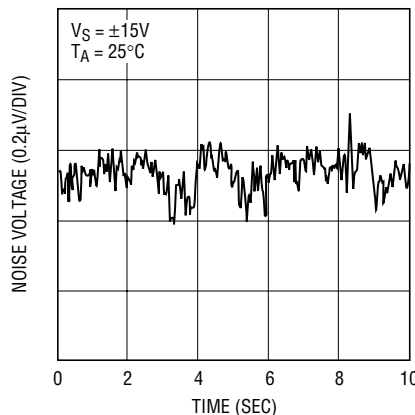

LT1112/14 • TPC11

**0.01Hz to 1Hz Noise**

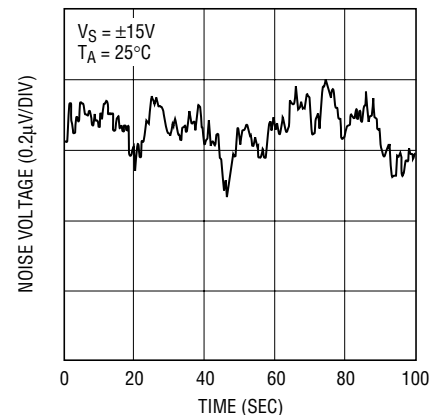

LT1112/14 • TPC12

**Warm-Up Drift**

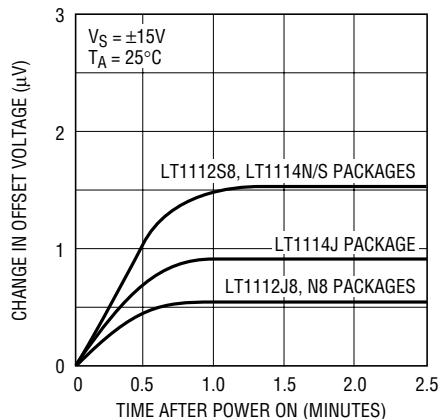

LT1112/14 • TPC13

**Long Term Stability of Three Representative Units**

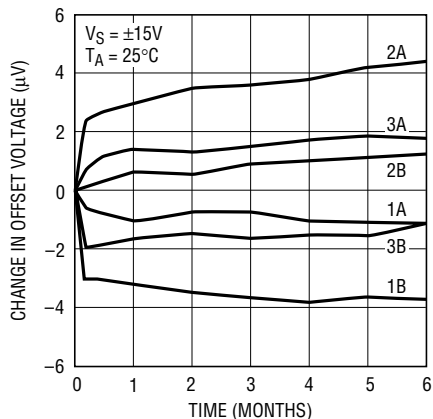

LT1112/14 • TPC14

**Supply Current per Amplifier vs Supply Voltage**

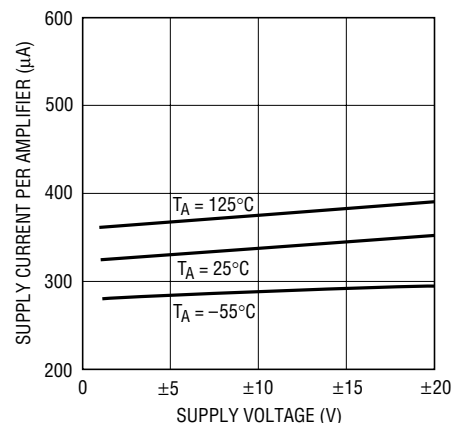

LT1112/14 • TPC15

# TYPICAL PERFORMANCE CHARACTERISTICS

**Minimum Supply Voltage vs Temp  
Voltage Gain at Minimum Supply Voltage**

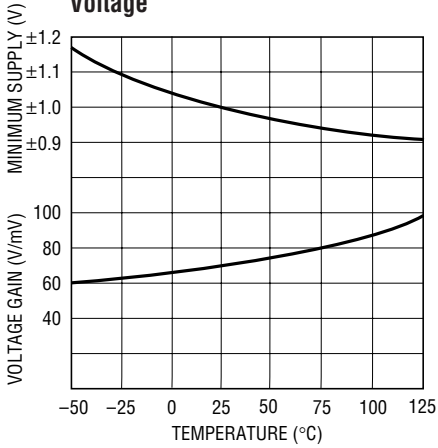

LT1112/14 • TPC16

**Common Mode Range and  
Voltage Swing with Respect to  
Supply Voltages**

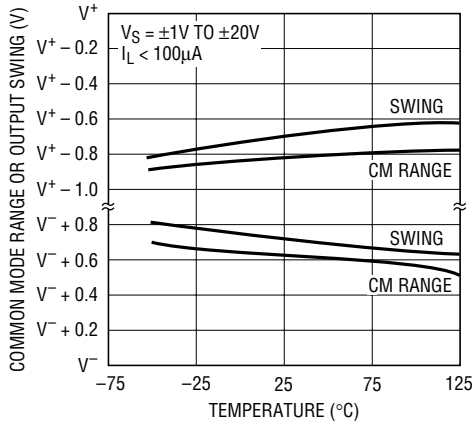

LT1112/14 • TPC17

**Output Voltage Swing  
vs Load Current**

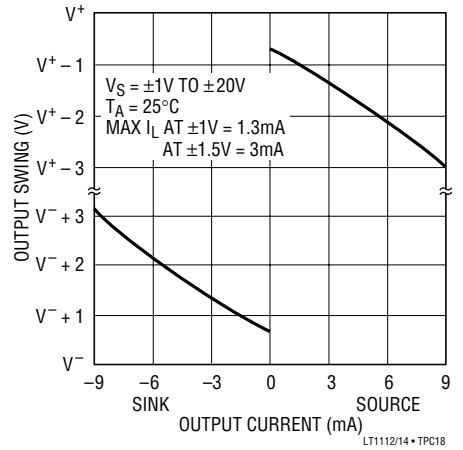

LT1112/14 • TPC18

**Voltage Gain**

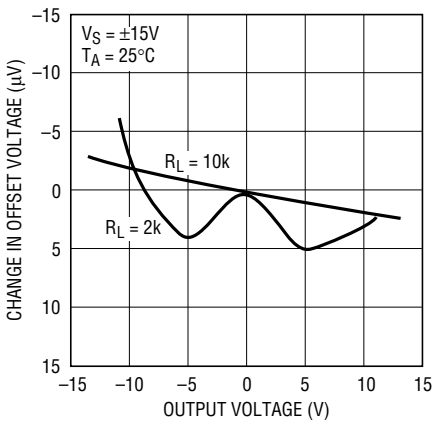

LT1112/14 • TPC19

**Voltage Gain vs Frequency**

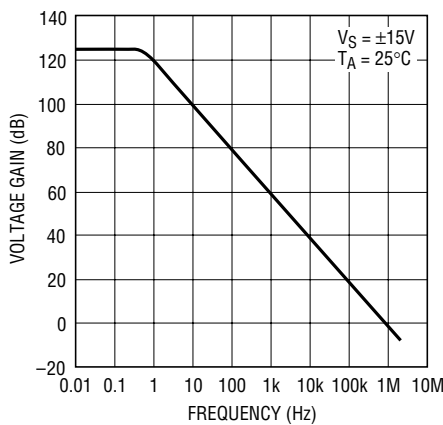

LT1112/14 • TPC20

**Gain, Phase Shift vs Frequency**

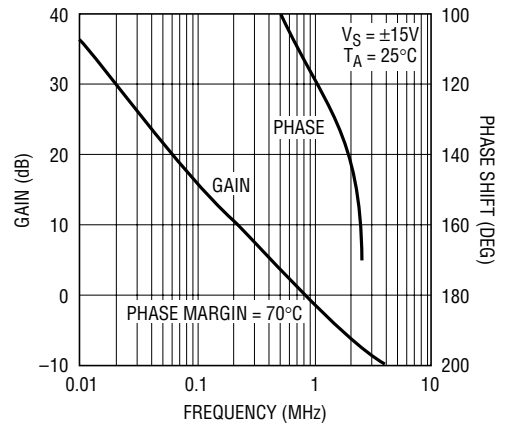

LT1112/14 • TPC21

**Common Mode Rejection  
vs Frequency**

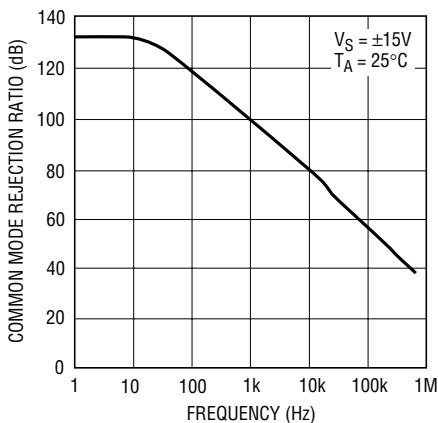

LT1112/14 • TPC22

**Power Supply Rejection  
vs Frequency**

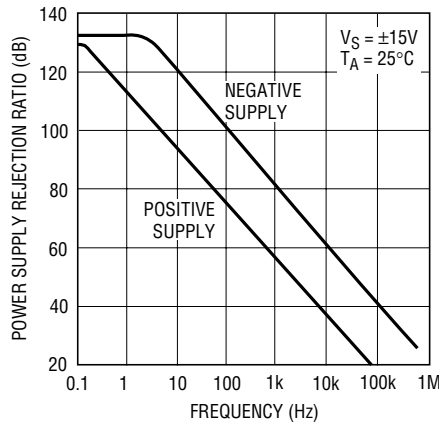

LT1112/14 • TPC23

**Channel Separation vs Frequency**

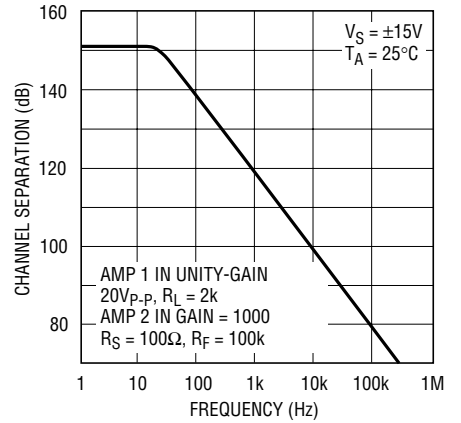

LT1112/14 • TPC24



# TYPICAL PERFORMANCE CHARACTERISTICS

**Slew Rate, Gain-Bandwidth Product and Phase Margin vs Temperature**

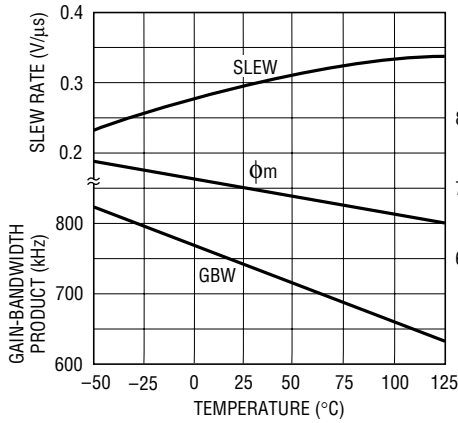

LT1112/14 • TPC25

**Closed-Loop Output Impedance**

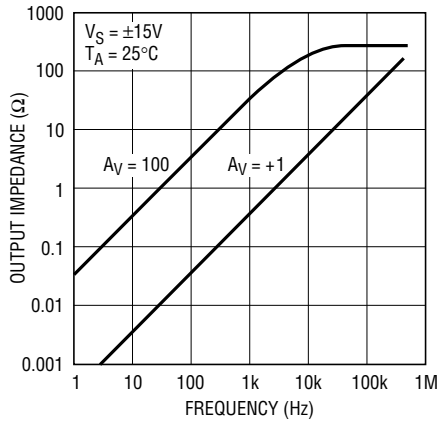

LT1112/14 • TPC26

**Capacitive Loading Handling**

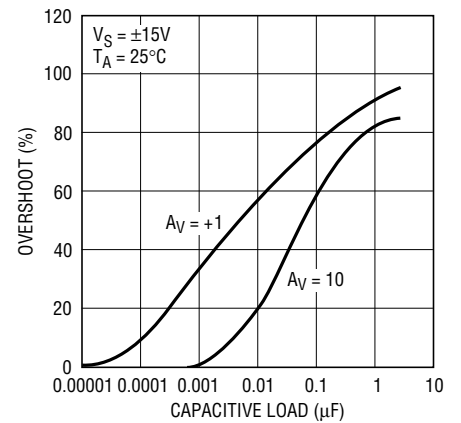

LT1112/14 • TPC27

**Small-Signal Transient Response**

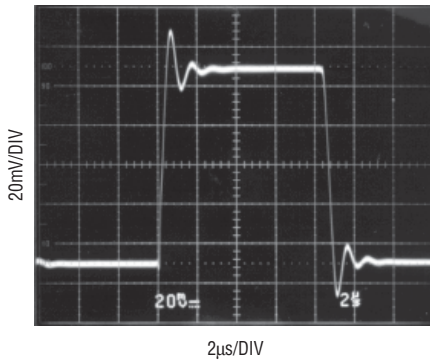

$A_V = +1$   
 $C_L = 500\text{pF}$   
 $V_S = \pm 15\text{V}$

**Large-Signal Transient Response**

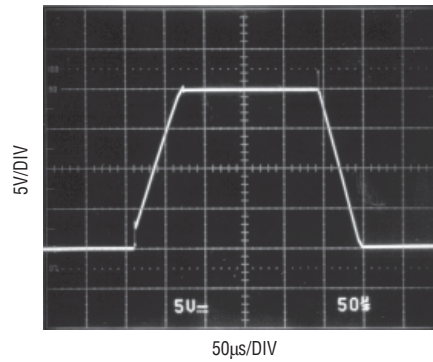

$A_V = +1$   
 $R_F = 10\text{k}$   
 $C_F = 100\text{pF}$   
 $V_S = \pm 15\text{V}$

**Undistorted Output Voltage vs Frequency**

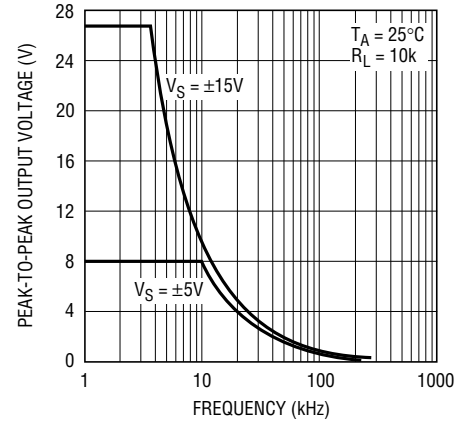

LT1112/14 • TPC30

## APPLICATIONS INFORMATION

The LT1112 dual and LT1114 quad in the plastic and ceramic DIP packages are pin compatible to and directly replace such precision op amps as the OP-200, OP-297, AD706 duals and OP-400, OP-497, AD704 quads with improved price/performance.

The LT1112 in the S8 surface mount package has the standard pin configuration, i.e., the same configuration as the plastic and ceramic DIP packages.

The LT1114 quad is offered in the narrow 16-pin surface mount package. All competitors are in the wide 16-pin package which occupies 1.8 times the area of the narrow package. The wide package is also 1.8 times thicker than the narrow package.

The inputs of the LT1112/1114 are protected with back-to-back diodes. In the voltage follower configuration, when the input is driven by a fast large-signal pulse (>1V), the input protection diodes effectively short the output to the input during slewing, and a current, limited only by the output short-circuit protection, will flow through the diodes.

The use of a feedback resistor is recommended because this resistor keeps the current below the short-circuit limit, resulting in faster recovery and settling of the output.

The input voltage of the LT1112/1114 should never exceed the supply voltages by more than a diode drop. However, the example below shows that as the input voltage exceeds the common mode range, the LT1112's

output clips cleanly, without any glitches or phase reversal. The OP-297 exhibits phase reversal. The photos also illustrate that both the input and output ranges of the LT1112 are within 800mV of the supplies. The effect of input and output overdrive on the other amplifiers in the LT1112 or LT1114 packages is negligible, as each amplifier is biased independently.

### Advantages of Matched Dual and Quad Op Amps

In many applications the performance of a system depends on the matching between two operational amplifiers rather than the individual characteristics of the two op amps. Two or three op amp instrumentation amplifiers, tracking voltage references and low drift active filters are some of the circuits requiring matching between two op amps.

The well-known triple op amp configuration illustrates these concepts. Output offset is a function of the difference between the offsets of the two halves of the LT1112. This error cancellation principle holds for a considerable number of input referred parameters in addition to offset voltage and its drift with temperature. Input bias current will be the average of the two noninverting input currents ( $I_B^+$ ). The difference between these two currents ( $\Delta I_B^+$ ) is the offset current of the instrumentation amplifier. Common mode and power supply rejections will be dependent only on the match between the two amplifiers (assuming perfect resistor matching).

Voltage Follower with Input Exceeding the Common Mode Range ( $V_S = \pm 5V$ )



INPUT:  $\pm 5.2V$  Sine Wave



LT1112 Output



OP-297 Output

## APPLICATIONS INFORMATION

### Three Op Amp Instrumentation Amplifier



The concepts of common mode and power supply rejection ratio match ( $\Delta\text{CMRR}$  and  $\Delta\text{PSRR}$ ) are best demonstrated with a numerical example:

Assume  $\text{CMRR}_A = +1\mu\text{V}/\text{V}$  or 120dB,  
 and  $\text{CMRR}_B = +0.75\mu\text{V}/\text{V}$  or 122.5dB,  
 then  $\Delta\text{CMRR} = 0.25\mu\text{V}/\text{V}$  or 132dB;  
 if  $\text{CMRR}_B = -0.75\mu\text{V}/\text{V}$  which is still 122.5dB,  
 then  $\Delta\text{CMRR} = 1.75\mu\text{V}/\text{V}$  or 115dB.

Clearly the LT1112/LT1114, by specifying and guaranteeing all of these matching parameters, can significantly improve the performance of matching-dependent circuits.

Typical performance of the instrumentation amplifier:

Input offset voltage = 35 $\mu\text{V}$   
 Offset voltage drift = 0.3 $\mu\text{V}/^\circ\text{C}$   
 Input bias current = 80pA  
 Input offset current = 100pA  
 Input resistance = 800G $\Omega$   
 Input noise = 0.42 $\mu\text{V}_{\text{P-P}}$

When the instrumentation amplifier is used with high impedance sources, the LT1114 is recommended because its CMRR vs frequency performance is better than the LT1112's. For example, with two matched 1M $\Omega$  source resistors, CMRR at 100Hz is 100dB with the LT1114, 76dB with the LT1112.

This difference is explained by the fact that capacitance between adjacent pins on an IC package is about 0.25pF (including package, socket and PC board trace capacitances).

On the dual op amp package, positive input A is next to the  $V^-$  pin (AC ground), while positive input B has no AC ground pin adjacent to it, resulting in a 0.25pF input capacitance mismatch. At 100Hz, 0.25pF represents a  $6.4 \cdot 10^9$  input impedance mismatch, which is only 76dB higher than the 1M $\Omega$  source resistors.

On the quad package, all four inputs are adjacent to a power supply terminal—therefore, there is no mismatch.

**SCHEMATIC DIAGRAM** (1/2 LT1112, 1/4 LT1114)



Q1 TO Q4 ARE SUPERGAIN TRANSISTORS

LT1112/14 • SD01

**PACKAGE DESCRIPTION**

**J8 Package**  
**8-Lead CERDIP (Narrow .300 Inch, Hermetic)**  
 (Reference LTC DWG # 05-08-1110)



**J Package**  
**14-Lead CERDIP (Narrow .300 Inch, Hermetic)**  
 (Reference LTC DWG # 05-08-1110)



**OBSOLETE PACKAGES**

# PACKAGE DESCRIPTION

## N8 Package 8-Lead PDIP (Narrow .300 Inch) (Reference LTC DWG # 05-08-1510)

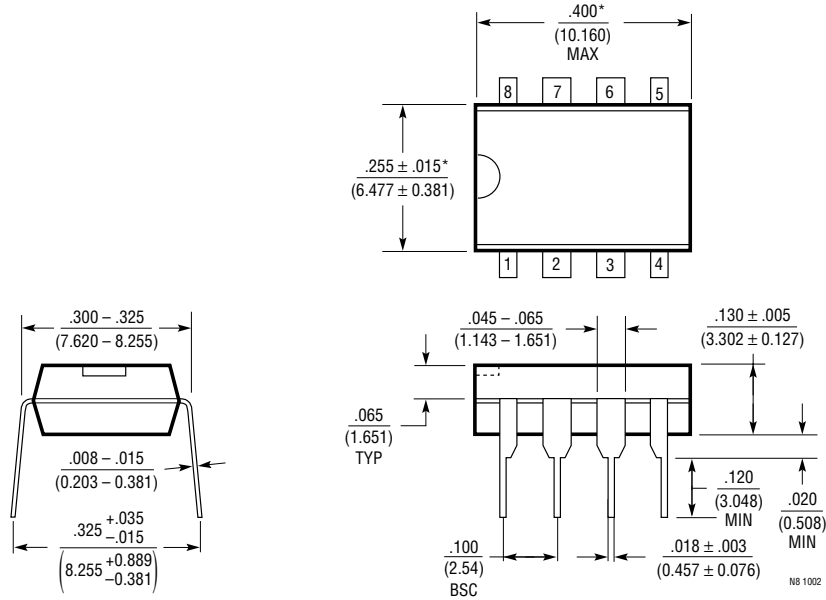

NOTE:  
1. DIMENSIONS ARE  $\frac{\text{INCHES}}{\text{MILLIMETERS}}$   
\*THESE DIMENSIONS DO NOT INCLUDE MOLD FLASH OR PROTRUSIONS.  
MOLD FLASH OR PROTRUSIONS SHALL NOT EXCEED .010 INCH (0.254mm)

## N Package 14-Lead PDIP (Narrow .300 Inch) (Reference LTC DWG # 05-08-1510)

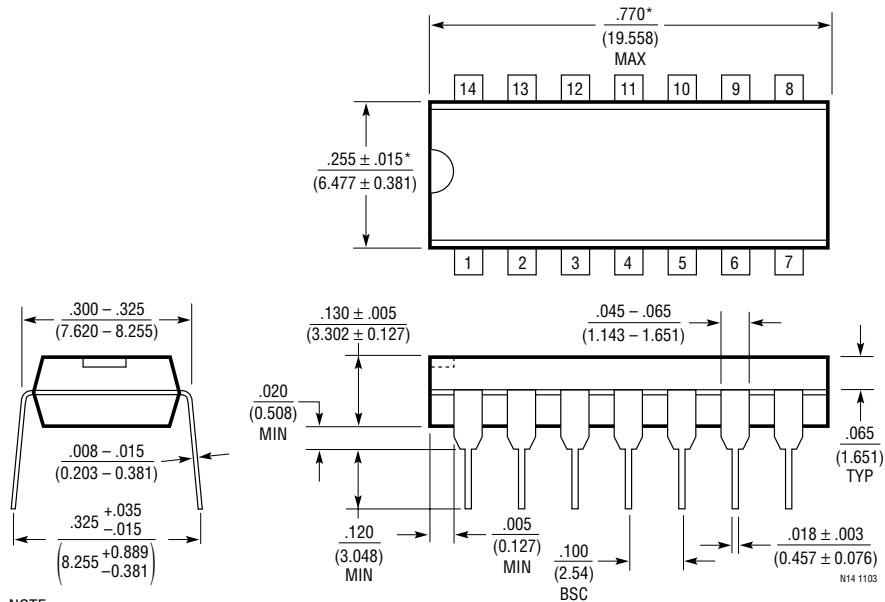

NOTE:  
1. DIMENSIONS ARE  $\frac{\text{INCHES}}{\text{MILLIMETERS}}$   
\*THESE DIMENSIONS DO NOT INCLUDE MOLD FLASH OR PROTRUSIONS.  
MOLD FLASH OR PROTRUSIONS SHALL NOT EXCEED .010 INCH (0.254mm)

# PACKAGE DESCRIPTION

## S8 Package 8-Lead Plastic Small Outline (Narrow .150 Inch) (Reference LTC DWG # 05-08-1610)



## S Package 16-Lead Plastic Small Outline (Narrow .150 Inch) (Reference LTC DWG # 05-08-1610)

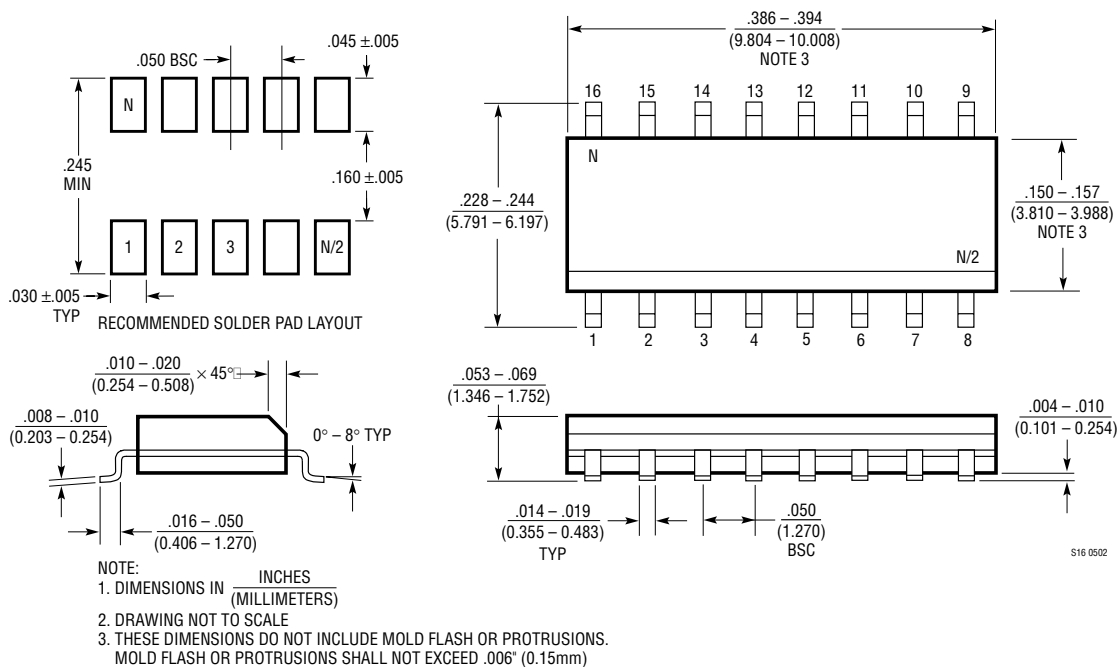

## TYPICAL APPLICATION

Dual Buffered  $\pm 0.617V$  Reference Powered by Two AA Batteries

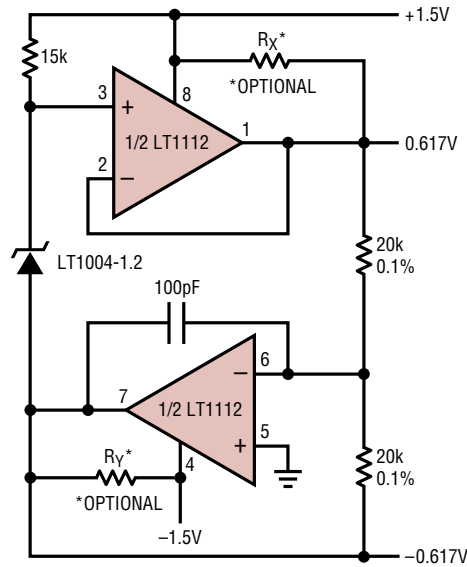

TOTAL SUPPLY CURRENT =  $700\mu A$   
 WORKS WITH BATTERIES DISCHARGED TO  $\pm 1.3V$   
 AT  $\pm 1.5V$ : MAXIMUM LOAD CURRENT =  $800\mu A$ ;  
 CAN BE INCREASED WITH OPTIONAL  $R_X, R_Y$ ;  
 AT  $R_X = R_Y = 750\Omega$  LOAD CURRENT =  $2mA$   
 TEMPERATURE COEFFICIENT LIMITED BY REFERENCE =  $20ppm/^{\circ}C$

LT1112/14 • TA03

## RELATED PARTS

PART NUMBER	DESCRIPTION	COMMENTS
LT1880	Rail-to-Rail Output, Picoamp Input Precision Op Amp	SOT-23
LT1881/LT1882	Dual/Quad Rail-to-Rail Output, Picoamp Input Precision Op Amp	$C_{LOAD}$ Up to $1000pF$
LT1884/LT1885	Dual/Quad Rail-to-Rail Output, Picoamp Input Precision Op Amp	$9.5nV/\sqrt{Hz}$ Input Noise
LT6011/LT6012	Dual/Quad Rail-to-Rail Output, Picoamp Input Precision Op Amp	$135\mu A$ Supply Current, $14nV/\sqrt{Hz}$



## Данный компонент на территории Российской Федерации

### Вы можете приобрести в компании MosChip.

Для оперативного оформления запроса Вам необходимо перейти по данной ссылке:

<http://moschip.ru/get-element>

Вы можете разместить у нас заказ для любого Вашего проекта, будь то серийное производство или разработка единичного прибора.

В нашем ассортименте представлены ведущие мировые производители активных и пассивных электронных компонентов.

Нашей специализацией является поставка электронной компонентной базы двойного назначения, продукции таких производителей как XILINX, Intel (ex.ALTERA), Vicor, Microchip, Texas Instruments, Analog Devices, Mini-Circuits, Amphenol, Glenair.

Сотрудничество с глобальными дистрибьюторами электронных компонентов, предоставляет возможность заказывать и получать с международных складов практически любой перечень компонентов в оптимальные для Вас сроки.

На всех этапах разработки и производства наши партнеры могут получить квалифицированную поддержку опытных инженеров.

Система менеджмента качества компании отвечает требованиям в соответствии с ГОСТ Р ИСО 9001, ГОСТ РВ 0015-002 и ЭС РД 009

### Офис по работе с юридическими лицами:

105318, г.Москва, ул.Щербаковская д.3, офис 1107, 1118, ДЦ «Щербаковский»

Телефон: +7 495 668-12-70 (многоканальный)

Факс: +7 495 668-12-70 (доб.304)

E-mail: [info@moschip.ru](mailto:info@moschip.ru)

Skype отдела продаж:

moschip.ru

moschip.ru\_4

moschip.ru\_6

moschip.ru\_9