

# HIGH POWER TWIN RELAY

## 1 POLE x 2 - 30A (for automotive applications)

### FBR562 Series

#### ■ FEATURES

- Two independent relays mounted in a single package
  - High current capacity  
(carrying current: 40 A/2 minutes, 30 A/1 hour)
  - High heat resistance and extended operating voltage
  - Contact gap 0.4mm
  - RoHS compliant
- Please see page 7 for more information



#### ■ PARTNUMBER INFORMATION

[Example]    FBR562    N    D12    -    W1    -    \*\*  
                   (a)           (b)           (c)           (d)           (e)

(a)	Relay type	FBR562 : FBR562 Series (relay for 12V battery, contact gap 0.4mm)
(b)	Enclosure	Nil : Flux proof N : Plastic sealed type
(c)	Coil rated voltage	D12 : 6...12 VDC Coil rating table at page 2
(d)	Contact material	W1 : Silver-tin oxide indium Y : Silver-tin oxide
(e)	Special type	To be assigned custom specification

Actual marking does not carry the type name: "FBR"  
 E.g.: Ordering code: FBR562ND12-W1 Actual marking: 562ND12-W1

# FBR562 SERIES

## ■ SPECIFICATION

Item	FBR562		
Contact Data	Configuration	1 form C x 2 (SPDT x 2)	
	Material	Silver-tin oxide indium (-W1 type) Silver-tin oxide (-Y type)	
	Voltage drop	Max. 100 mV at 1A, 12VDC	
	Contact rating	14VDC, 30A (locked motor load) 14VDC, inrush 27A, break 4A (motor free load)	
	Max. carrying current	40A/2 minutes, 30A/1 hour (25 °C, 100% rated coil voltage)	
	Max. inrush current	70A (-W1 type) (reference)	
	Max. switching voltage	16VDC (reference)	
	Max. switching current	40A (reference)	
	Min. switching load *	6 VDC, 1A (-W1 type) (reference)	
Life	Mechanical	Min. 10 x 10 <sup>6</sup> operations	
	Electrical	Min. 100 x 10 <sup>3</sup> operations (locked motor load) Min. 1 x 10 <sup>6</sup> operations (motor free load)	
Coil Data	Operating temperature range	-40 °C to +85 °C (no frost)	
	Storage temperature range	-40 °C to +100 °C (no frost)	
Timing Data	Operate (at nominal voltage)	Max. 10 ms	
	Release (at nominal voltage)	Max. 5 ms	
Other	Vibration resistance	10 to 55Hz double amplitude 1.5mm	
	Shock	Misoperation	100m/s <sup>2</sup>
		Endurance	1,000m/s <sup>2</sup>
	Weight	Approximately 18 g	

\* Minimum switching loads mentioned above are reference values. Please perform the confirmation test with actual load before production since reference values may vary according to switching frequencies, environmental conditions and expected reliability levels.

## ■ COIL RATING

Coil Code	Rated Coil Voltage (VDC)	Coil Resistance +/- 10% (Ohm)	Must Operate Voltage (VDC) *	Thermal resistance (°C / W)
D06	6	42	3.6 (at 20 °C)	77
			4.5 (at 85 °C)	
D09	9	95	5.4 (at 20 °C)	
			6.8 (at 85 °C)	
D12	12	170	7.3 (at 20 °C)	
			9.2 (at 85 °C)	

Note: All values in the table are valid for 20°C and zero contact current, unless otherwise stated..

\* Specified operate values are valid for pulse wave voltage.

# FBR562 SERIES

## ■ PRINCIPAL APPLICATIONS

Application		Normal load current	Life x 10 <sup>3</sup>	Recommended model (Example)
For 12V battery	Power windows	20A tot 30A (switching at motor locking)	100	FBR562N ( ) -W1
	Automatic door lock	18A to 30A / 4 to 5 door (switching at motor locking)	100	FBR562N ( ) -W1
	Intermittent wipers	Inrush 15A to 30A Break 2A to 8A (motor free)	300	FBR562N ( ) -W1
	Tilt-lock wheel	Inrush 15A Break 2.5A (motor free)	100	FBR562N ( ) -W1
	Sunroof	20A to 30A (switching at motor locking)	100	FBR562N ( ) -W1
	Others	Car audio system, etc.	-	FBR562N ( ) -W1

## ■ CHARACTERISTIC DATA

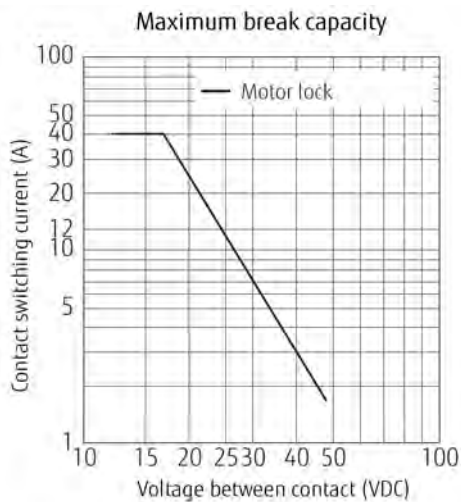

Test circuit

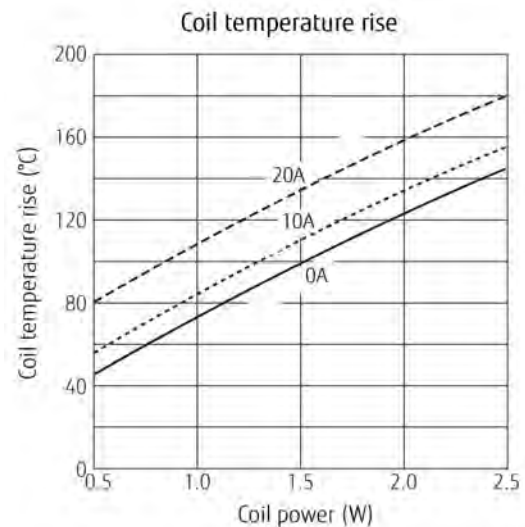
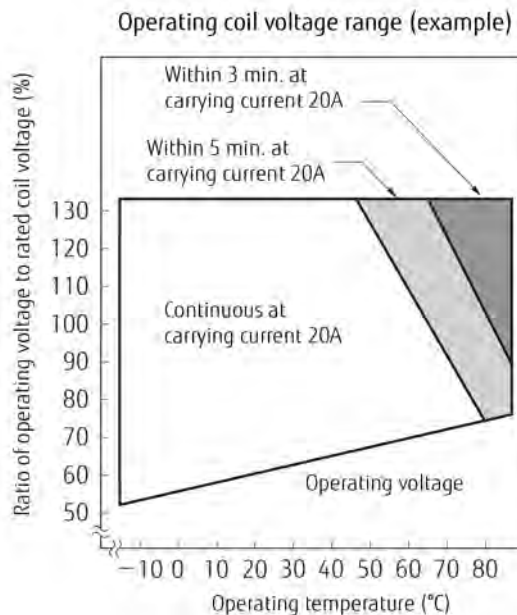
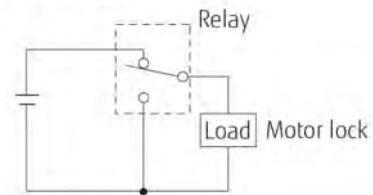

# FBR562 SERIES

Life test (example)

(1) Motor lock

Test item	Test circuit	Current wave form
20A, 14VDC Motor lock 200,000 operations minimum Contact material: Silver tin oxide indium		
30A, 14VDC Motor lock 100,000 operations minimum Contact material: Silver tin oxide indium		

(2) Motor free

Test item	Test circuit	Current wave form
Inrush 27A, Idle 4A 14VDC Motor free 100,000 operations minimum Contact material: Silver tin oxide indium		

# FBR562 SERIES

## Vibration resistance characteristics

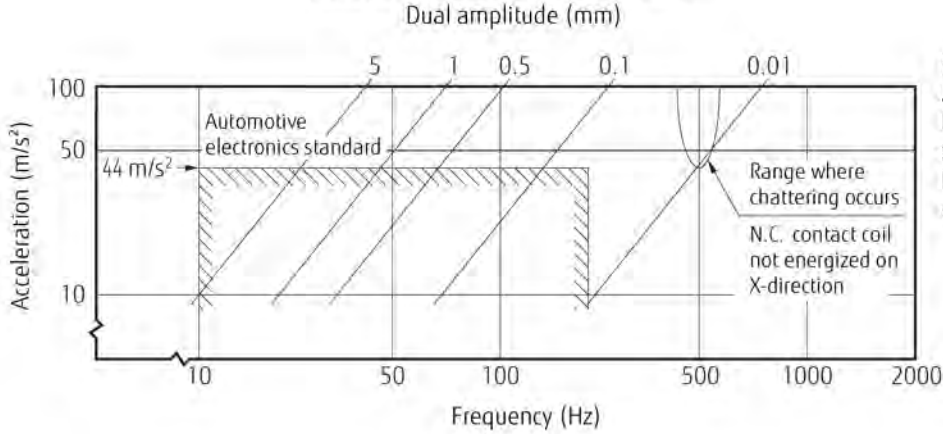

Frequency: 10~2000 Hz  
 Acceleration: 100 m/s<sup>2</sup> max.  
 Direction of vibration;  
 see diagram below  
 Detection level:  
 chatter > 100 μs



## Shock resistance characteristics

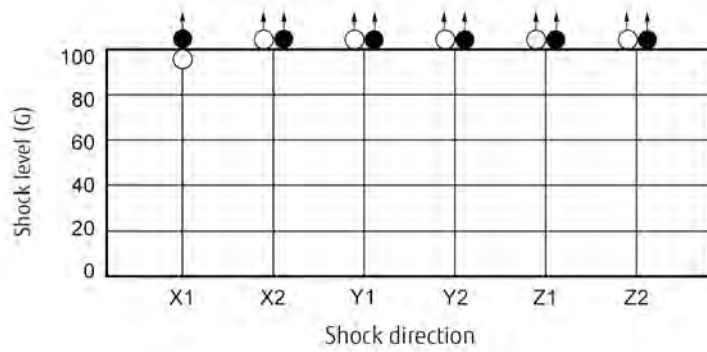

Shock application time: 11ms, half-sine wave  
 Test condition: coil energized and de-energized  
 Shock direction: see diagram below  
 Detection level: chatter > 100 μs

- : N.C. contact (coil de-energized)
- : N.O. contact (coil energized)

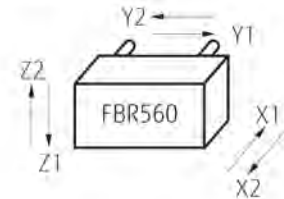

All directions ≥ 1,000 m/s<sup>2</sup>

## Distribution of operate/release voltage

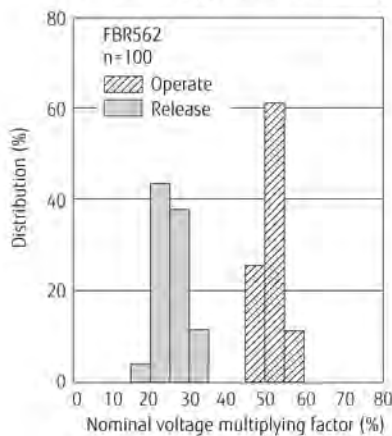

## Distribution of operate/release time

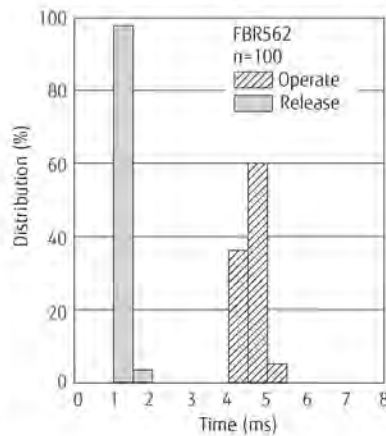

## Distribution of contact resistance

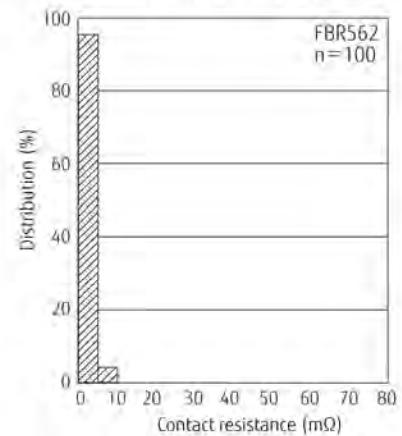

# FBR562 SERIES

## ■ DIMENSIONS

### ● Dimensions

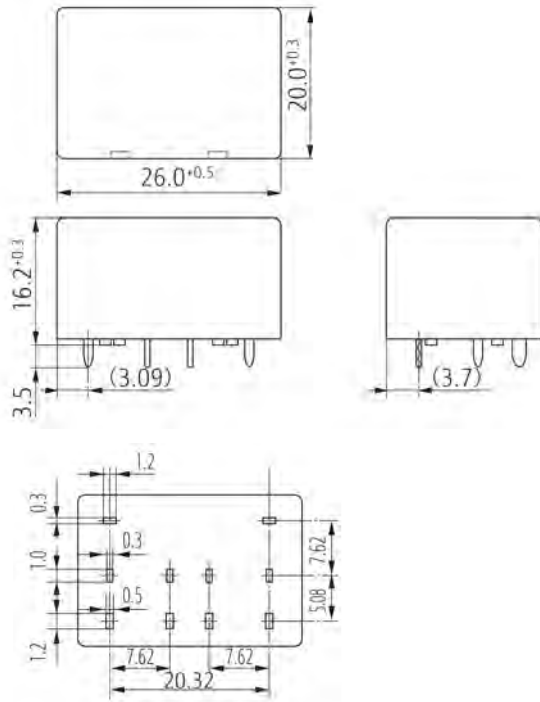

### ● Schematics (BOTTOM VIEW)

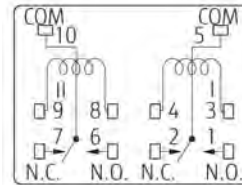

### ● PC board mounting hole layout (BOTTOM VIEW)

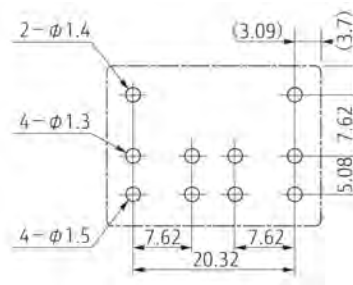

### ● Tube carrier

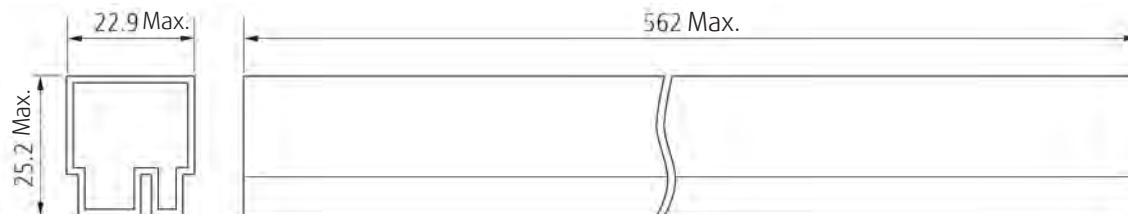

Unit: mm

## RoHS Compliance and Lead Free Information

### 1. General Information

- All relays produced by Fujitsu Components are compliant with RoHS directive 2011/65/EU including amendments.
- Cadmium as used in electrical contacts is exempted from the RoHS directives. As per Annex III of directive 2011/65/EU.
- All relays are lead-free. Please refer to Lead-Free Status Info for older date codes at: <http://www.fujitsu.com/downloads/MICRO/fcai/relays/lead-free-letter.pdf>
- Lead free solder plating on relay terminals is Sn-3.0Ag-0.5Cu, unless otherwise specified. This material has been verified to be compatible with PbSn assembly process.

### 2. Recommended Lead Free Solder Condition

- Recommended solder Sn-3.0Ag-0.5Cu.

**Flow Solder condition:**

Pre-heating: maximum 120°C  
Soldering: dip within 5 sec. at  
260°C solder bath

**Solder by Soldering Iron:**

Soldering Iron  
Temperature: maximum 360°C  
Duration: maximum 3 sec.

**We highly recommend that you confirm your actual solder conditions**

### 3. Moisture Sensitivity

- Moisture Sensitivity Level standard is not applicable to electromechanical relays, unless otherwise indicated.

### 4. Tin Whiskers

- Dipped SnAgCu solder is known as presenting a low risk to tin whisker development. No considerable length whisker was found by our in house test.

## Fujitsu Components International Headquarter Offices

### Japan

Fujitsu Component Limited  
Gotanda-Chuo Building  
3-5, Higashigotanda 2-chome, Shinagawa-ku  
Tokyo 141, Japan  
Tel: (81-3) 5449-7010  
Fax: (81-3) 5449-2626  
Email: [promothq@ft.ed.fujitsu.com](mailto:promothq@ft.ed.fujitsu.com)  
Web: [www.fcl.fujitsu.com](http://www.fcl.fujitsu.com)

### North and South America

Fujitsu Components America, Inc.  
250 E. Caribbean Drive  
Sunnyvale, CA 94089 U.S.A.  
Tel: (1-408) 745-4900  
Fax: (1-408) 745-4970  
Email: [components@us.fujitsu.com](mailto:components@us.fujitsu.com)  
Web: <http://us.fujitsu.com/components>

### Europe

Fujitsu Components Europe B.V.  
Diamantlaan 25  
2132 WV Hoofddorp  
Netherlands  
Tel: (31-23) 5560910  
Fax: (31-23) 5560950  
Email: [info@fceu.fujitsu.com](mailto:info@fceu.fujitsu.com)  
Web: [emea.fujitsu.com/components/](http://emea.fujitsu.com/components/)

### Asia Pacific

Fujitsu Components Asia Ltd.  
102E Pasir Panjang Road  
#01-01 Citilink Warehouse Complex  
Singapore 118529  
Tel: (65) 6375-8560  
Fax: (65) 6273-3021  
Email: [fcalfcal.fujitsu.com](mailto:fcalfcal.fujitsu.com)  
Web: <http://www.fujitsu.com/sg/services/micro/components/>

©2013 Fujitsu Components Europe B.V. All rights reserved. All trademarks or registered trademarks are the property of their respective owners.

The contents, data and information in this datasheet are provided by Fujitsu Component Ltd. as a service only to its user and only for general information purposes.

The use of the contents, data and information provided in this datasheet is at the users' own risk.

Fujitsu has assembled this datasheet with care and will endeavor to keep the contents, data and information correct, accurate, comprehensive, complete and up to date.

Fujitsu Components Europe B.V. and affiliated companies do however not accept any responsibility or liability on their behalf, nor on behalf of its employees, for any loss or damage, direct, indirect or consequential, with respect to this datasheet, its contents, data, and information and related graphics and the correctness, reliability, accuracy, comprehensiveness, usefulness, availability and completeness thereof.

Nor do Fujitsu Components Europe B.V. and affiliated companies accept on their behalf, nor on behalf of its employees, any responsibility or liability for any representation or warrant of any kind, express or implied, including warranties of any kind for merchantability or fitness for particular use, with respect to these datasheets, its contents, data, information and related graphics and the correctness, reliability, accuracy, comprehensiveness, usefulness, availability and completeness thereof. Rev. July 03, 2013



# Mouser Electronics

Authorized Distributor

Click to View Pricing, Inventory, Delivery & Lifecycle Information:

Fujitsu:

[FBR562ND12-N](#) [FBR562ND12-W](#) [FBR562ND06-N](#) [FBR562ND06-W](#) [FBR562ND09-N](#) [FBR562ND09-W](#)  
[FBR562ND12-W1](#)

## Данный компонент на территории Российской Федерации

### Вы можете приобрести в компании MosChip.

Для оперативного оформления запроса Вам необходимо перейти по данной ссылке:

<http://moschip.ru/get-element>

Вы можете разместить у нас заказ для любого Вашего проекта, будь то серийное производство или разработка единичного прибора.

В нашем ассортименте представлены ведущие мировые производители активных и пассивных электронных компонентов.

Нашей специализацией является поставка электронной компонентной базы двойного назначения, продукции таких производителей как XILINX, Intel (ex.ALTERA), Vicor, Microchip, Texas Instruments, Analog Devices, Mini-Circuits, Amphenol, Glenair.

Сотрудничество с глобальными дистрибьюторами электронных компонентов, предоставляет возможность заказывать и получать с международных складов практически любой перечень компонентов в оптимальные для Вас сроки.

На всех этапах разработки и производства наши партнеры могут получить квалифицированную поддержку опытных инженеров.

Система менеджмента качества компании отвечает требованиям в соответствии с ГОСТ Р ИСО 9001, ГОСТ РВ 0015-002 и ЭС РД 009

### Офис по работе с юридическими лицами:

105318, г.Москва, ул.Щербаковская д.3, офис 1107, 1118, ДЦ «Щербаковский»

Телефон: +7 495 668-12-70 (многоканальный)

Факс: +7 495 668-12-70 (доб.304)

E-mail: [info@moschip.ru](mailto:info@moschip.ru)

Skype отдела продаж:

moschip.ru

moschip.ru\_4

moschip.ru\_6

moschip.ru\_9