



Is Now Part of



**ON Semiconductor®**

To learn more about ON Semiconductor, please visit our website at  
[www.onsemi.com](http://www.onsemi.com)

Please note: As part of the Fairchild Semiconductor integration, some of the Fairchild orderable part numbers will need to change in order to meet ON Semiconductor's system requirements. Since the ON Semiconductor product management systems do not have the ability to manage part nomenclature that utilizes an underscore (\_), the underscore (\_) in the Fairchild part numbers will be changed to a dash (-). This document may contain device numbers with an underscore (\_). Please check the ON Semiconductor website to verify the updated device numbers. The most current and up-to-date ordering information can be found at [www.onsemi.com](http://www.onsemi.com). Please email any questions regarding the system integration to [Fairchild\\_questions@onsemi.com](mailto:Fairchild_questions@onsemi.com).

ON Semiconductor and the ON Semiconductor logo are trademarks of Semiconductor Components Industries, LLC dba ON Semiconductor or its subsidiaries in the United States and/or other countries. ON Semiconductor owns the rights to a number of patents, trademarks, copyrights, trade secrets, and other intellectual property. A listing of ON Semiconductor's product/patent coverage may be accessed at [www.onsemi.com/site/pdf/Patent-Marking.pdf](http://www.onsemi.com/site/pdf/Patent-Marking.pdf). ON Semiconductor reserves the right to make changes without further notice to any products herein. ON Semiconductor makes no warranty, representation or guarantee regarding the suitability of its products for any particular purpose, nor does ON Semiconductor assume any liability arising out of the application or use of any product or circuit, and specifically disclaims any and all liability, including without limitation special, consequential or incidental damages. Buyer is responsible for its products and applications using ON Semiconductor products, including compliance with all laws, regulations and safety requirements or standards, regardless of any support or applications information provided by ON Semiconductor. "Typical" parameters which may be provided in ON Semiconductor data sheets and/or specifications can and do vary in different applications and actual performance may vary over time. All operating parameters, including "Typicals" must be validated for each customer application by customer's technical experts. ON Semiconductor does not convey any license under its patent rights nor the rights of others. ON Semiconductor products are not designed, intended, or authorized for use as a critical component in life support systems or any FDA Class 3 medical devices or medical devices with a same or similar classification in a foreign jurisdiction or any devices intended for implantation in the human body. Should Buyer purchase or use ON Semiconductor products for any such unintended or unauthorized application, Buyer shall indemnify and hold ON Semiconductor and its officers, employees, subsidiaries, affiliates, and distributors harmless against all claims, costs, damages, and expenses, and reasonable attorney fees arising out of, directly or indirectly, any claim of personal injury or death associated with such unintended or unauthorized use, even if such claim alleges that ON Semiconductor was negligent regarding the design or manufacture of the part. ON Semiconductor is an Equal Opportunity/Affirmative Action Employer. This literature is subject to all applicable copyright laws and is not for resale in any manner.



# FAN7081\_GF085 High Side Gate Driver



## Features

- Qualified to AEC Q100
- Floating channel designed for bootstrap operation up fully operational to + 600V
- Tolerance to negative transient voltage on VS pin
- dV/dt immune.
- Gate drive supply range from 10V to 20V
- Under-voltage lockout
- CMOS Schmit-triggered inputs with pull-up
- High side output out of phase with input (Inverted input)

## Typical Applications

- Diesel and gasoline Injectors/Valves
- MOSFET-and IGBT high side driver applications



For Fairchild's definition of "green" Eco Status, please visit:  
[http://www.fairchildsemi.com/company/green/rohs\\_green.html](http://www.fairchildsemi.com/company/green/rohs_green.html)

## Description

The FAN7081\_GF085 is a high-side gate drive IC designed for high voltage and high speed driving of MOSFET or IGBT, which operates up to 600V. Fairchild's high-voltage process and common-mode noise cancellation technique provide stable operation in the high side driver under high-dV/dt noise circumstances. An advanced level-shift circuit allows high-side gate driver operation up to VS=-5V (typical) at VBS=15V. Logic input is compatible with standard CMOS outputs. The UVLO circuits prevent from malfunction when VCC and VBS are lower than the specified threshold voltage. It is available with space saving SOIC-8 Package. Minimum source and sink current capability of output driver is 250mA and 500mA respectively, which is suitable for magnetic- and piezo type injectors and general MOSFET/IGBT based high side driver applications.

### SOIC-8

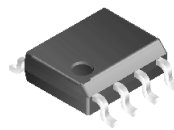

## Ordering Information

Device	Package	Operating Temp.
FAN7081M_GF085	SOIC-8	-40 °C ~ 125 °C
FAN7081MX_GF085	SOIC-8	-40 °C ~ 125 °C

X : Tape & Reel type

### Block Diagrams

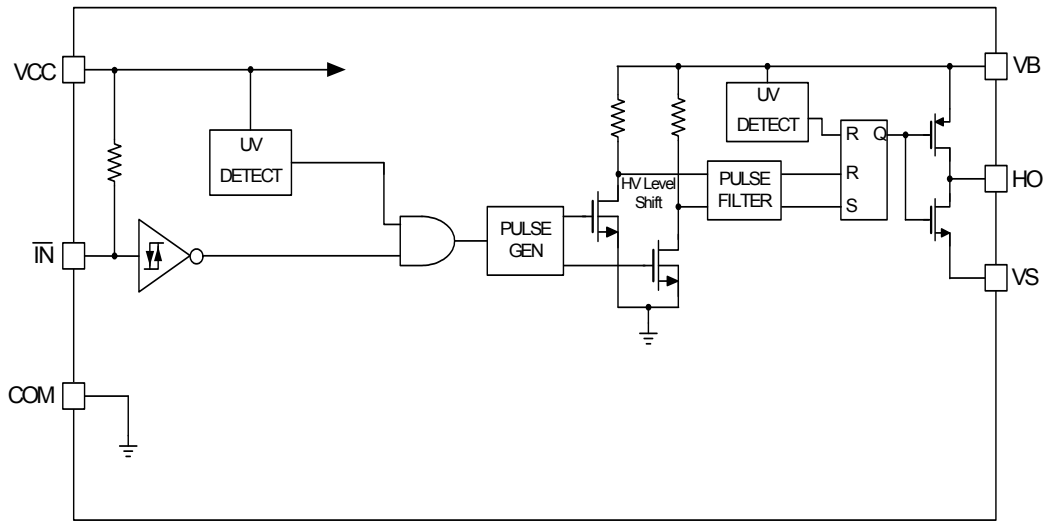

### Pin Assignments

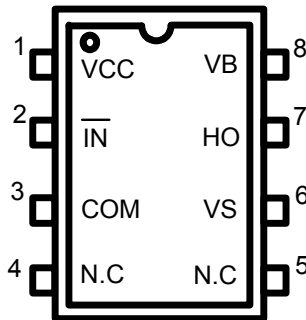

### Pin Definitions

Pin Number	Pin Name	I/O	Pin Function Description
1	VCC	P	Driver supply voltage
2	$\overline{\text{IN}}$	I	Logic input for high side gate drive output, out of phase with HO
3	COM	P	Ground
4	NC	-	NC
5	NC	-	NC
6	VS	P	High side floating offset for MOSFET Source connection
7	HO	A	High side drive output for MOSFET Gate connection
8	VB	P	Driver output stage supply

## Absolute Maximum Ratings

Absolute Maximum Ratings indicate sustained limits beyond which damage to the device may occur. All voltage parameters are absolute voltages referenced to COM.

Parameter	Symbol	Min.	Max.	Unit
High side floating supply offset voltage	VS	VB-25	VB+0.3	V
High side floating supply voltage	VB	-0.3	625	V
High side floating output voltage	VHO	VS-0.3	VB+0.3	V
Supply voltage	VCC	-0.3	25	V
Input voltage for $\overline{\text{IN}}$	VIN	-0.3	VCC+0.3	V
Power Dissipation <sup>1)</sup>	Pd		0.625	W
Thermal resistance, junction to ambient <sup>1)</sup>	Rthja		200	°C/W
Electrostatic discharge voltage (Human Body Model)	V <sub>ESD</sub>	1K		V
Charge device model	V <sub>CDM</sub>	500		V
Junction Temperature	T <sub>J</sub>		150	°C
Storage Temperature	T <sub>S</sub>	-55	150	°C

Note: 1) The thermal resistance and power dissipation rating are measured bellow conditions;

JESD51-2: Integrated Circuit Thermal Test Method Environmental Conditions - Natural codition(StillAir)

JESD51-3: Low Effective Thermal Conductivity Test Board for Leaded Surface Mount Package

## Recommended Operating Conditions

For proper operations the device should be used within the recommended conditions.  $-40^{\circ}\text{C} \leq \text{Ta} \leq 125^{\circ}\text{C}$

Parameter	Symbol	Min.	Max.	Unit
High side floating supply voltage(DC) Transient:-10V@ 0.2 us	VB	VS + 10	VS + 20	V
High side floating supply offset voltage(DC)	VS	-4 (@VBS >= 10V) -5 (@VBS >= 11.5V)	600	V
High side floating supply offset voltage(Transient)	VS	-25 (~200ns) -20(200ns ~240ns) -7(240ns~400ns)	600	V
High side floating output voltage	VHO	VS	VB	V
Allowable offset voltage Slew Rate <sup>1)</sup>	dv/dt	-	50	V/ns
Supply voltage	VCC	10	20	V
Input voltage for $\overline{\text{IN}}$	VIN	0	Vcc	V
Switching Frequency <sup>2)</sup>	Fs		200	KHz
Minimum Pulse Width <sup>(3)</sup>	T <sub>pulse</sub>	85	-	ns
Ambient Temperature	Ta	-40	125	°C

Note: 1) Guaranteed by design.

2) Duty = 0.5

3) Guaranteed by design. Refer to Figure4a,4b and 4c on Page 8.

## Statics Electrical Characteristics

Unless otherwise specified,  $-40^{\circ}\text{C} \leq T_a \leq 125^{\circ}\text{C}$ ,  $V_{CC} = 15\text{V}$ ,  $V_{BS} = 15\text{V}$ ,  $V_S = 0\text{V}$ ,  $R_L = 50\Omega$ ,  $C_L = 2.5\text{nF}$ .

Parameter	Symbol	Conditions	Min.	Typ.	Max.	Unit
<b>Vcc and VBS supply Characteristics</b>						
VCC and VBS supply under voltage positive going threshold	VCCUV+ VBSUV+		-	8.7	9.8	V
VCC and VBS supply under voltage negative going threshold	VCCUV- VBSUV-		7.4	8.2	-	V
VCC and VBS supply under voltage hysteresis	VCCUVH VBSUVH	-	0.2	0.5	-	V
Under voltage lockout response time	tduvcc tduvbs	VCC: 10V-->7.3V or 7.3V-->10V VBS: 10V-->7.3V or 7.3V-->10V	0.5 0.5		20 20	us us
Offset supply leakage current	ILK	$V_B = V_S = 600\text{V}$	-	-	50	$\mu\text{A}$
Quiescent VBS supply current	IQBS	$V_{IN} = 0$	-	23	250	$\mu\text{A}$
Quiescent Vcc supply current	IQCC1	$V_{IN} = 0\text{V}$	-	42	120	$\mu\text{A}$
Quiescent Vcc supply current	IQCC2	$V_{IN} = 15\text{V}$	-	25	100	$\mu\text{A}$
<b>Input Characteristics</b>						
High logic level input voltage	$V_{IH}$		$0.63V_{CC}$	-	-	V
Low logic level input voltage	$V_{IL}$		-	-	$0.4V_{CC}$	V
Low logic level input bias current for IN	$I_{IN+}$	$V_{IN} = 0$	-	15	50	$\mu\text{A}$
High logic level input bias current for IN	$I_{IN-}$	$V_{IN} = 15\text{V}$	-	0	1	$\mu\text{A}$
<b>Output characteristics</b>						
High level output voltage, $V_{BIAS-VO}$	$V_{OH}$	$I_O = 0$	-	-	0.1	V
Low level output voltage, $V_O$	$V_{OL}$	$I_O = 0$	-	-	0.1	V
Peak output source current	$I_{O1+}$		250	-	-	mA
Peak output sink current	$I_{O1-}$		500	-	-	mA
Equivalent output resistance	ROP			40	60	$\Omega$
	RON			20	30	$\Omega$

Note: The input parameter are referenced to COM. The VO and IO parameters are referenced to COM.

## Dynamic Electrical Characteristics

Unless otherwise specified,  $-40^{\circ}\text{C} \leq T_a \leq 125^{\circ}\text{C}$ ,  $V_{CC} = 15\text{V}$ ,  $V_{BS} = 15\text{V}$ ,  $V_S = 0\text{V}$ ,  $R_L = 50\Omega$ ,  $C_L = 2.5\text{nF}$ .

Parameter	Symbol	Conditions	Min.	Typ.	Max.	Unit
Input-to-output turn-on propagation delay	t <sub>plh</sub>	50% input level to 10% output level, V <sub>S</sub> = 0V		130	300	ns
Input-to-output turn-off propagation delay	t <sub>phl</sub>	50% input level to 90% output level V <sub>S</sub> = 0V	-	140	300	ns
Output rising time	t <sub>r1</sub>	10% to 90%, T <sub>j</sub> =25°C, V <sub>BS</sub> =15V	-	15	400	ns
	t <sub>r2</sub>	10% to 90%		-	500	ns
Output falling time	t <sub>f1</sub>	90% to 10%, T <sub>j</sub> =25°C, V <sub>BS</sub> =15V	-	10	150	ns
	t <sub>f2</sub>	90% to 10%		-	500	ns

## Application Information

### 1. Relationship in input/output and supplies

Table.1 Truth table for Vcc, VBS, VIN, and VHO			
VCC	VBS	IN	HO
< VCCUVLO-	X	X	OFF
X	< VBSUVLO-	X	OFF
X	X	HIGH	OFF
> VCCUVLO+	> VBSUVLO+	LOW	ON

Notes:

X means independent from signal

### Typical Application Circuit

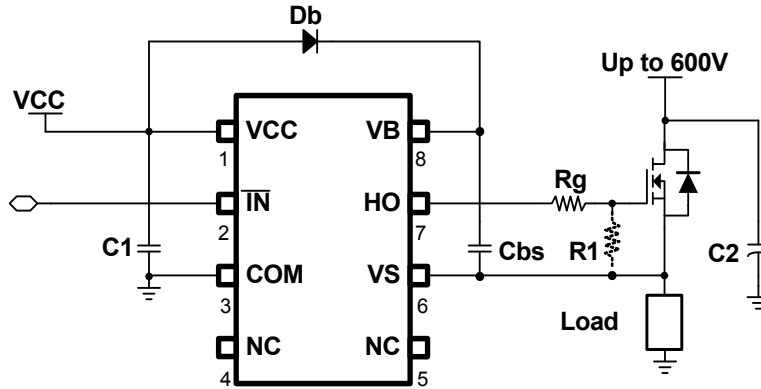

### Typical Waveforms

#### 1. Input/Output Timing

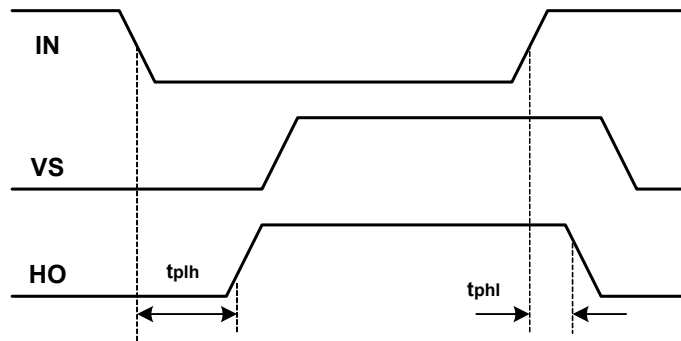

Figure 1. Input /output Timing Diagram

#### 2. Output(HO) Switching Timing

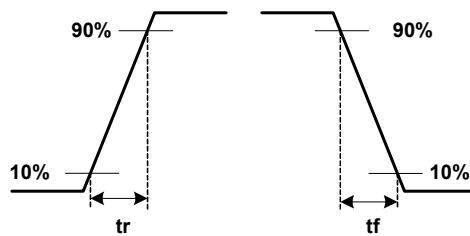

Figure 2. Switching Time Waveform Definitions



3.VB Drop Voltage Diagram

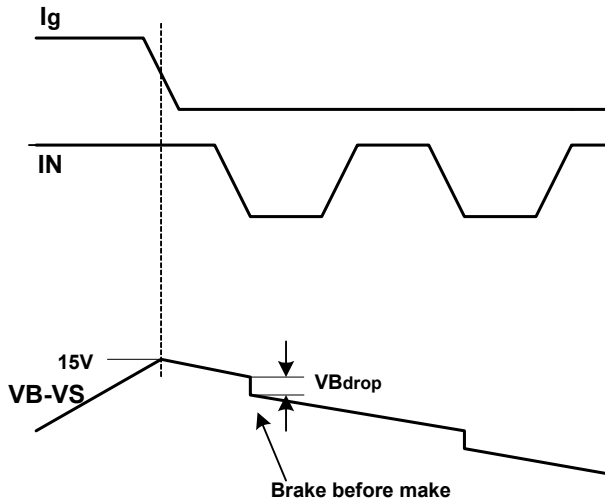

Figure 3a. VB Drop Voltage Diagram

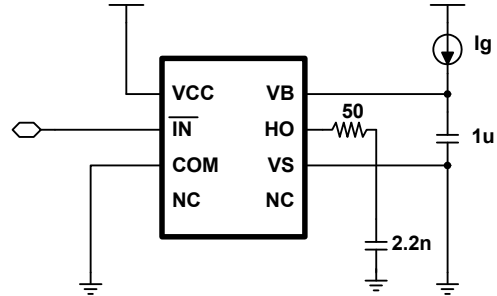

Figure3b. VB Drop Voltage Test Circuit

4.Recommendation Min. Short Pulse Width

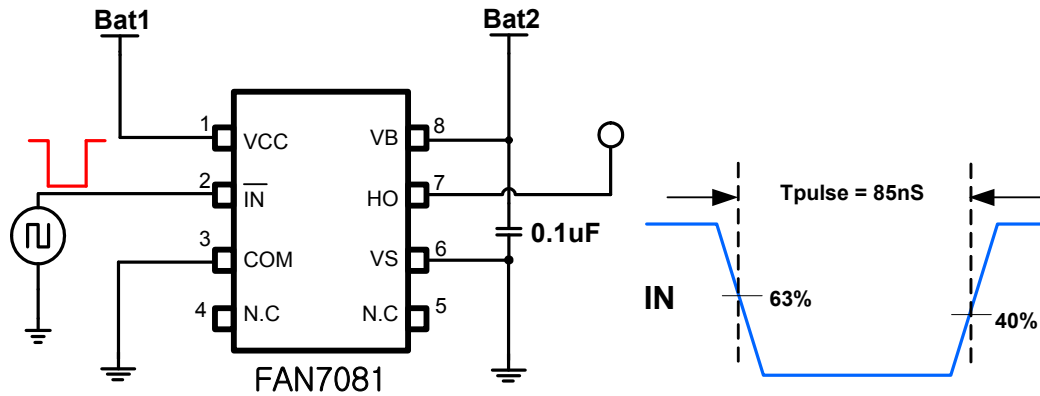

Figure 4a.Short Pulse Width Test Circuit and Pulse Width Waveform

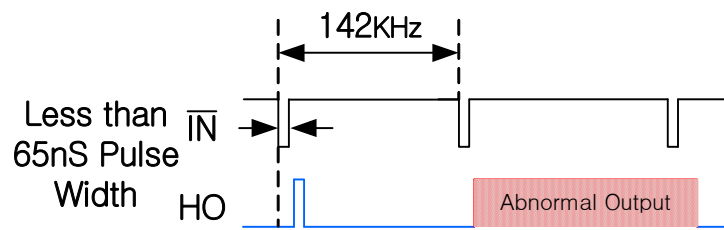

Figure 4b. Abnormal Output Waveform with short pulse width

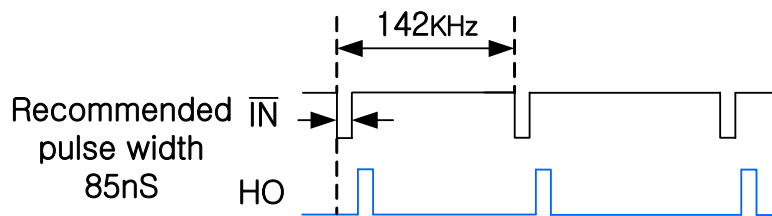

Figure 4c. Recommendation of pulse width Output Waveform

## Performance Graphs

This performance graphs based on ambient temperature -40°C ~125°C

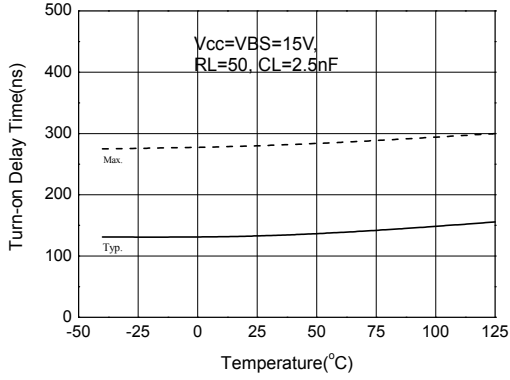

Figure 5a. Turn-On Delay Time vs Temperature

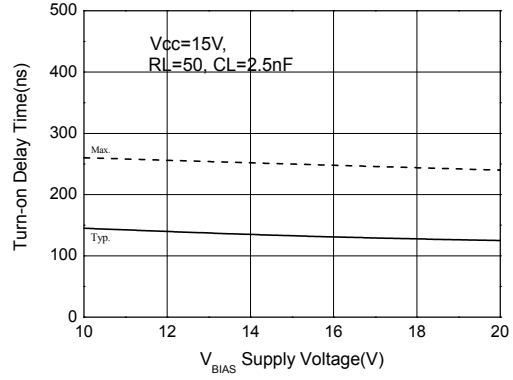

Figure 5b. Turn-On Delay Time vs VBS Supply Voltage

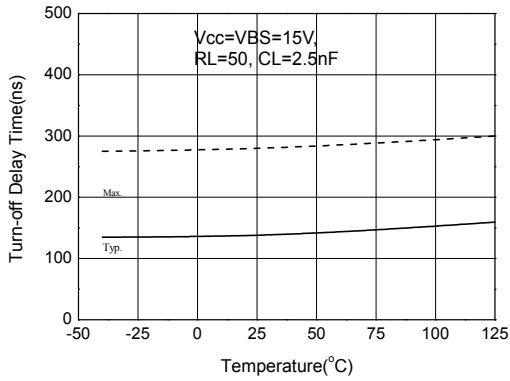

Figure 6a. Turn-Off Delay Time vs Temperature

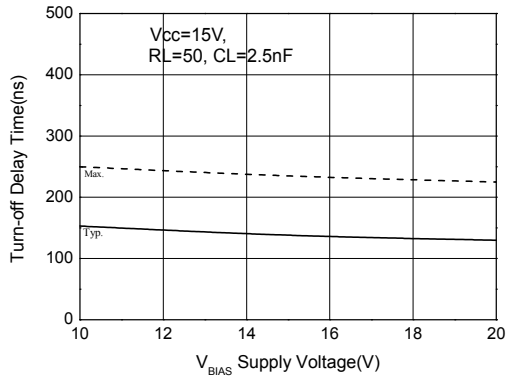

Figure 6b. Turn-Off Delay Time vs VBS Supply Voltage

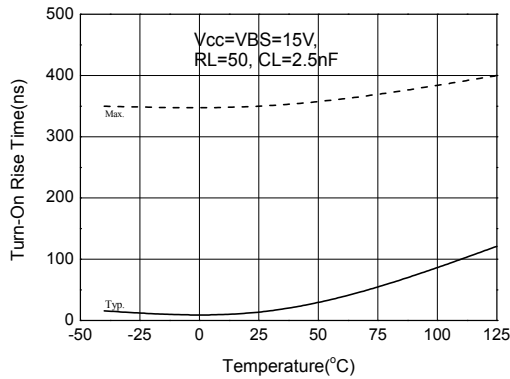

Figure 7a. Turn-On Rising Time vs Temperature

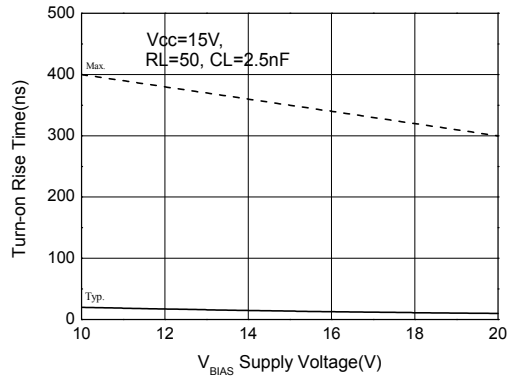

Figure 7b. Turn-ON Rising Time vs VBS Supply Voltage

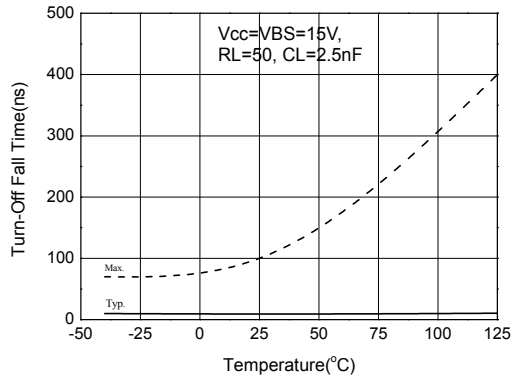

Figure 8a. Turn-Off Falling Time vs Temperature

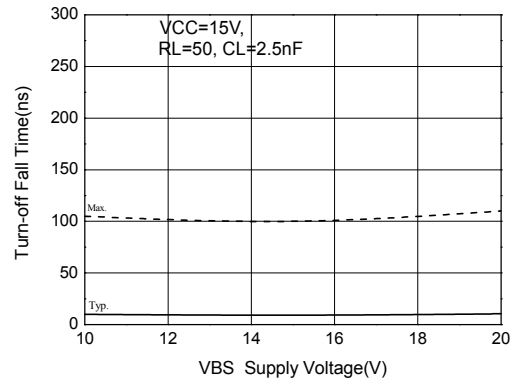

Figure 8b. Turn-Off Falling Time vs VBS Supply Voltage

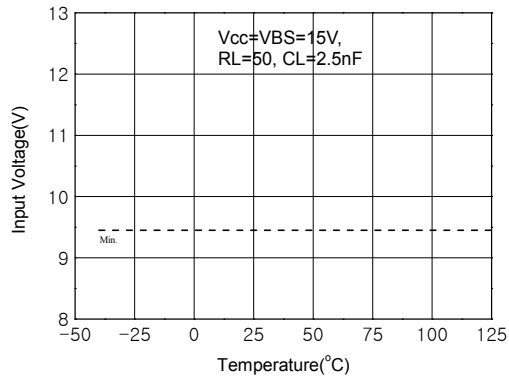

Figure 9a. Logic "1" IN Voltage vs Temperature

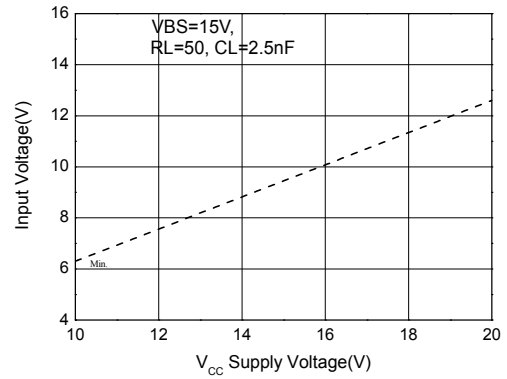

Figure 9b. Logic "1" IN Voltage vs VCC Supply Voltage

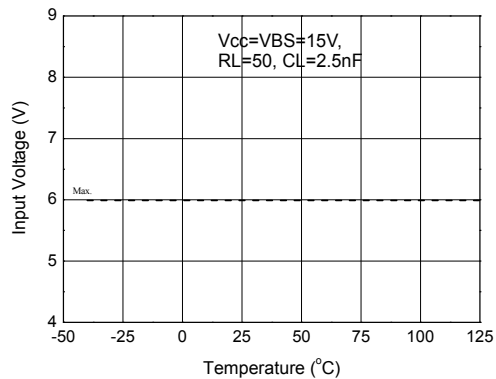

Figure 10a. Logic "0" IN Voltage vs Temperature

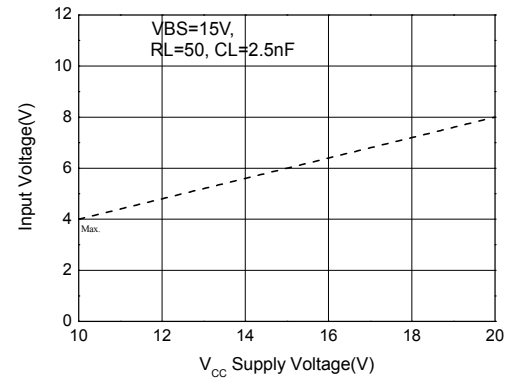

Figure 10b. Logic "0" IN Voltage vs VCC Supply Voltage

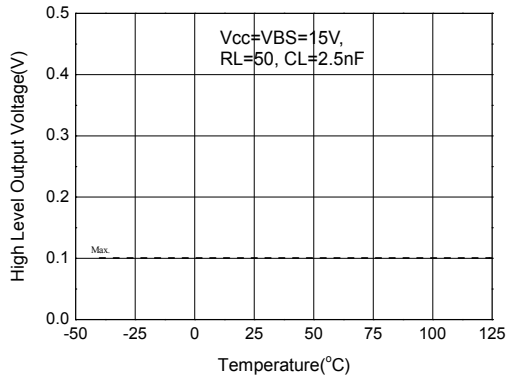

Figure 11a. High Level Output vs Temperature

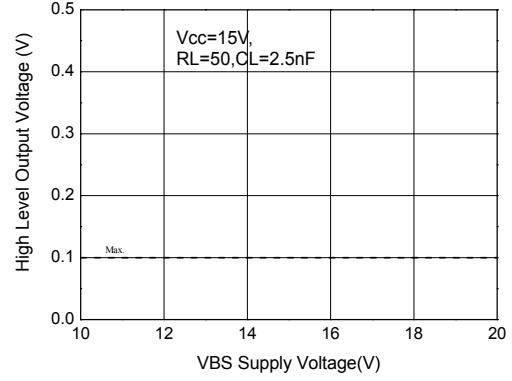

Figure 11b. High Level Output vs VBS Supply Voltage

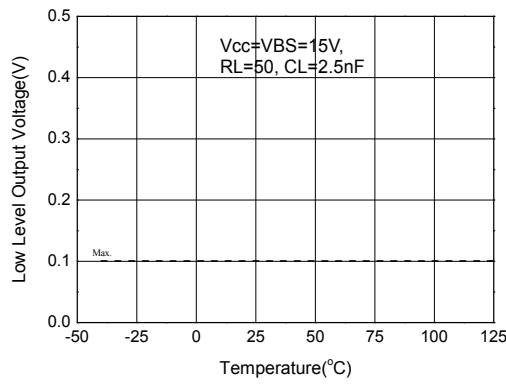

Figure 12a. Low Level Output vs Temperature

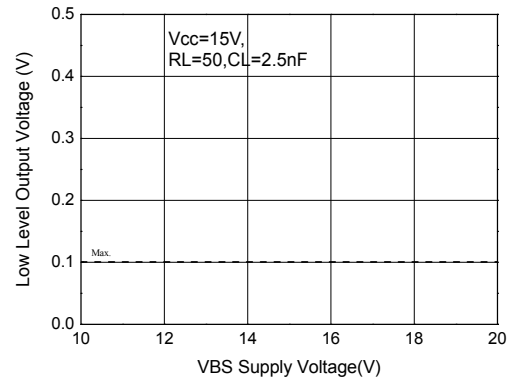

Figure 12b. Low Level Output vs VBS Supply Voltage

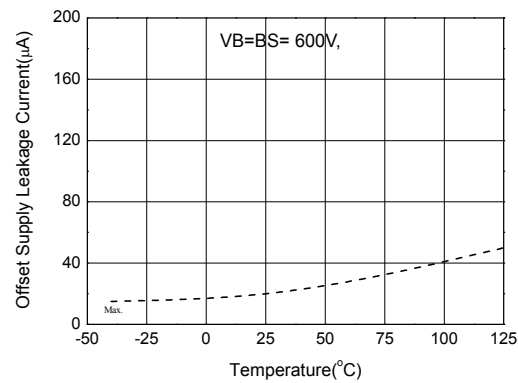

Figure 13a. Offset Supply Leakage Current vs Temperature

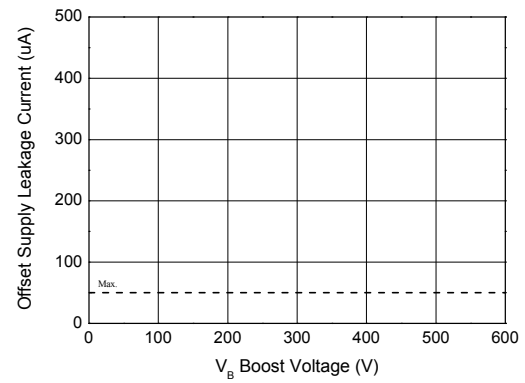

Figure 13b. Offset Supply Leakage Current vs  $V_B$  Boost Voltage

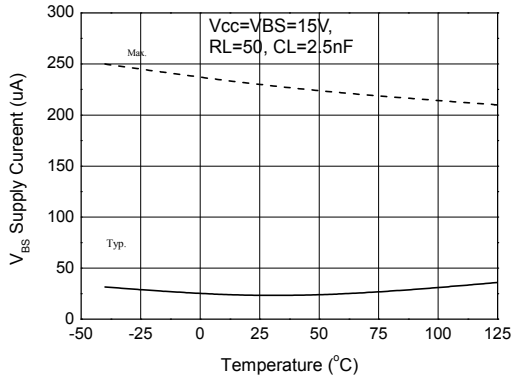

Figure 14a. VBS Supply Current vs Temperature

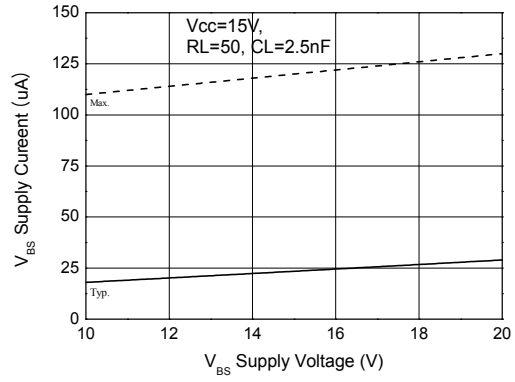

Figure 14b. VBS Supply Current vs VBS Supply Voltage

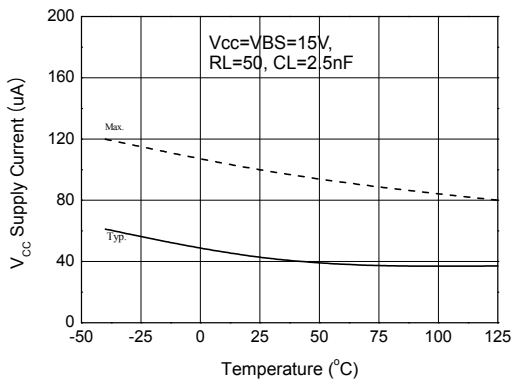

Figure 15a. VCC Supply Current vs Temperature

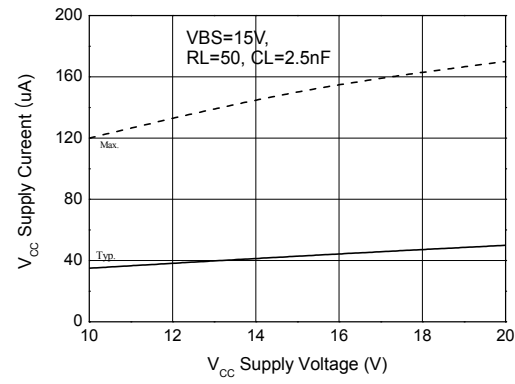

Figure 15b. VCC Supply Current vs VCC Supply Voltage

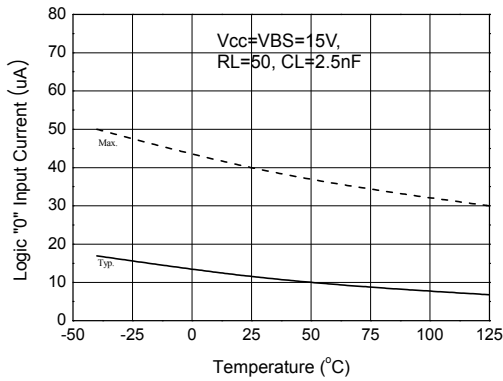

Figure 16a. Logic "0" IN Current vs Temperature

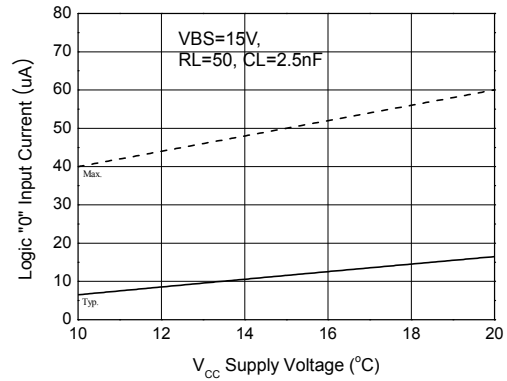

Figure 16b. Logic "0" IN Current vs VCC Supply Voltage

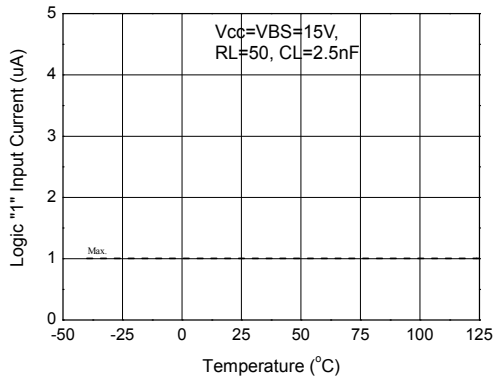

Figure 17a. Logic "1" IN Current vs Temperature

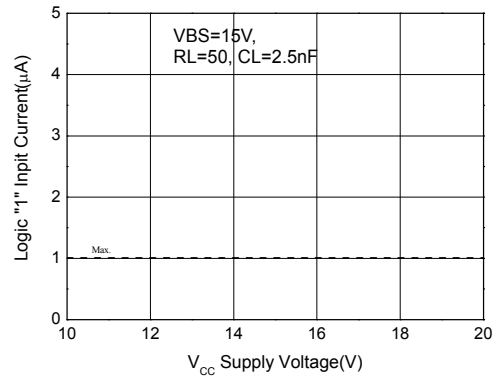

Figure 17b. Logic "1" IN Current vs VCC Supply Voltage

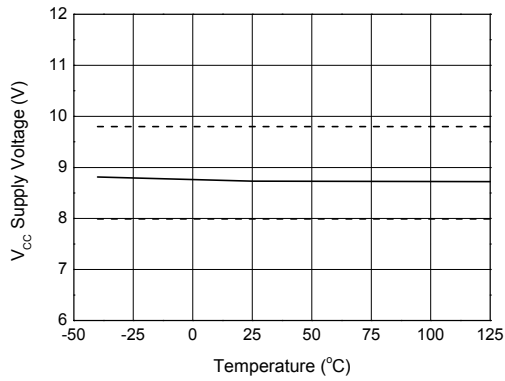

Figure 18a. VCC Under voltage Threshold(+) vs Temperature

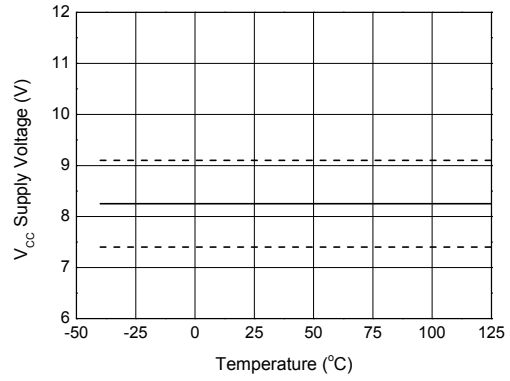

Figure 18b. VCC Under voltage Threshold(-) vs Temperature

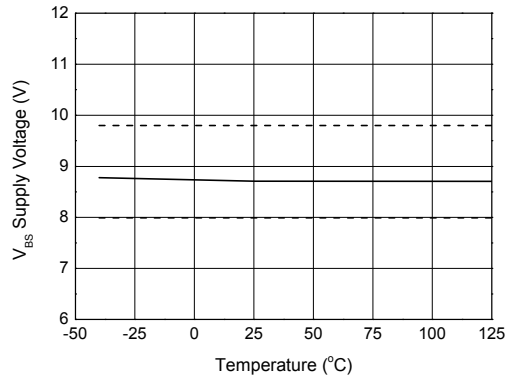

Figure 19a. VBS Under voltage Threshold(+) vs Temperature

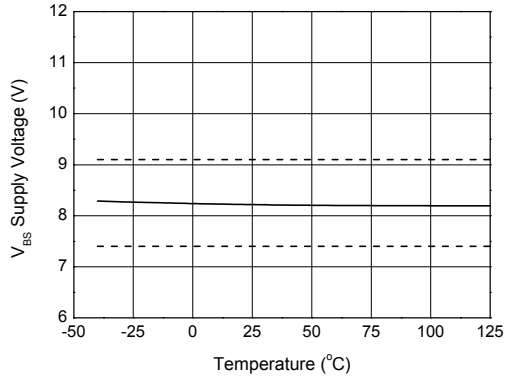

Figure 19b. VBS Under voltage Threshold(-) vs Temperature

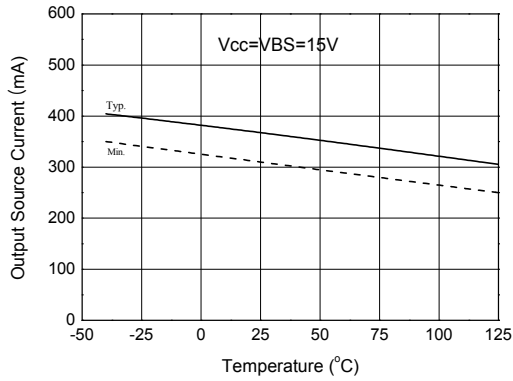

Figure 20a. Output Source Current vs Temperature

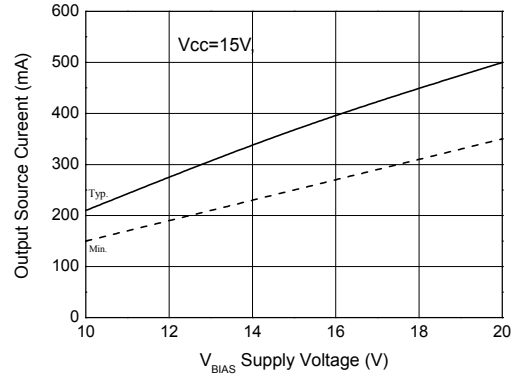

Figure 20b. Output Source Current vs VBS Supply Voltage

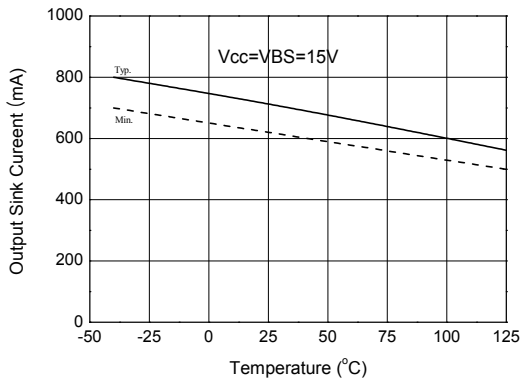

Figure 21a. Output Sink Current vs Temperature

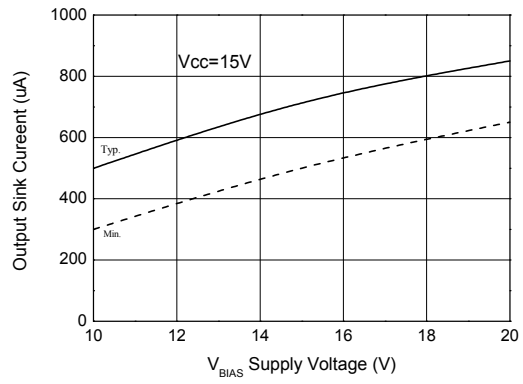

Figure 21b. Output Sink Current vs VBS Supply Voltage

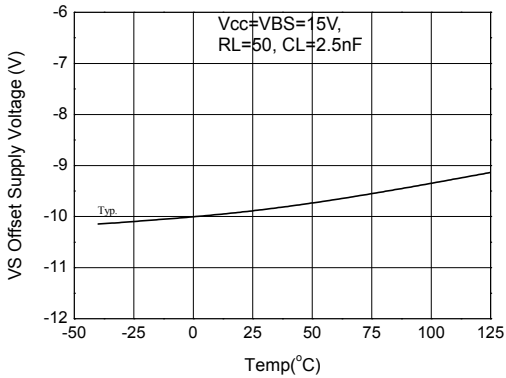

Figure 22a. Maximum VS Negative Voltage vs Temperature

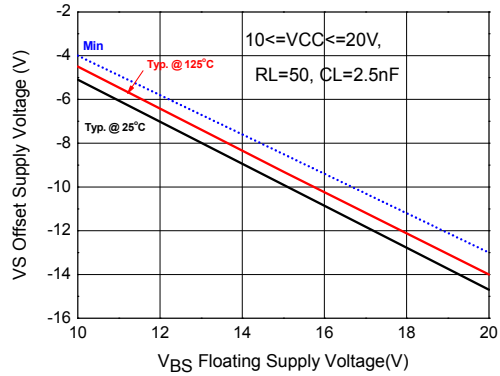
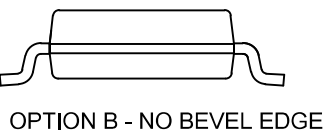
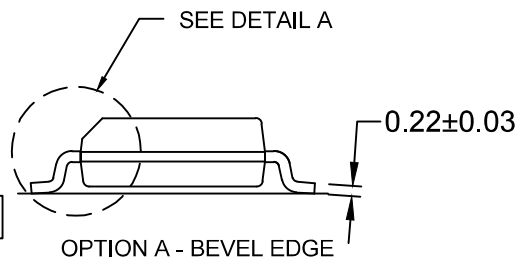
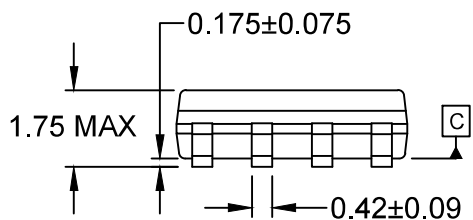
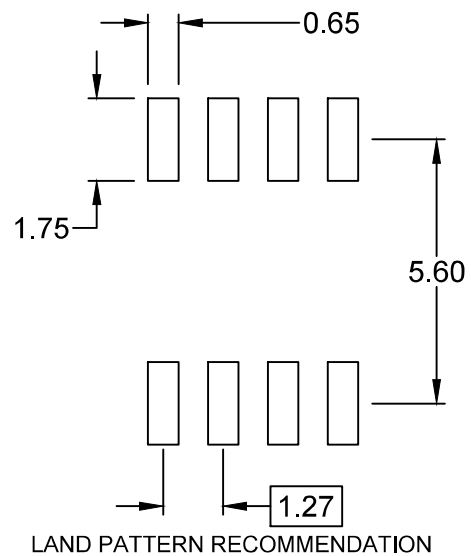

Figure 22b. Maximum VS Negative Voltage vs VBS Supply Voltage



NOTES:

- A) THIS PACKAGE CONFORMS TO JEDEC MS-012, VARIATION AA.
- B) ALL DIMENSIONS ARE IN MILLIMETERS.
- C) DIMENSIONS DO NOT INCLUDE MOLD FLASH OR BURRS.
- D) LANDPATTERN STANDARD: SOIC127P600X175-8M
- E) DRAWING FILENAME: M08Arev16





ON Semiconductor and  are trademarks of Semiconductor Components Industries, LLC dba ON Semiconductor or its subsidiaries in the United States and/or other countries. ON Semiconductor owns the rights to a number of patents, trademarks, copyrights, trade secrets, and other intellectual property. A listing of ON Semiconductor's product/patent coverage may be accessed at [www.onsemi.com/site/pdf/Patent-Marking.pdf](http://www.onsemi.com/site/pdf/Patent-Marking.pdf). ON Semiconductor reserves the right to make changes without further notice to any products herein. ON Semiconductor makes no warranty, representation or guarantee regarding the suitability of its products for any particular purpose, nor does ON Semiconductor assume any liability arising out of the application or use of any product or circuit, and specifically disclaims any and all liability, including without limitation special, consequential or incidental damages. Buyer is responsible for its products and applications using ON Semiconductor products, including compliance with all laws, regulations and safety requirements or standards, regardless of any support or applications information provided by ON Semiconductor. "Typical" parameters which may be provided in ON Semiconductor data sheets and/or specifications can and do vary in different applications and actual performance may vary over time. All operating parameters, including "Typicals" must be validated for each customer application by customer's technical experts. ON Semiconductor does not convey any license under its patent rights nor the rights of others. ON Semiconductor products are not designed, intended, or authorized for use as a critical component in life support systems or any FDA Class 3 medical devices or medical devices with a same or similar classification in a foreign jurisdiction or any devices intended for implantation in the human body. Should Buyer purchase or use ON Semiconductor products for any such unintended or unauthorized application, Buyer shall indemnify and hold ON Semiconductor and its officers, employees, subsidiaries, affiliates, and distributors harmless against all claims, costs, damages, and expenses, and reasonable attorney fees arising out of, directly or indirectly, any claim of personal injury or death associated with such unintended or unauthorized use, even if such claim alleges that ON Semiconductor was negligent regarding the design or manufacture of the part. ON Semiconductor is an Equal Opportunity/Affirmative Action Employer. This literature is subject to all applicable copyright laws and is not for resale in any manner.

## PUBLICATION ORDERING INFORMATION

### LITERATURE FULFILLMENT:

Literature Distribution Center for ON Semiconductor  
19521 E. 32nd Pkwy, Aurora, Colorado 80011 USA  
**Phone:** 303-675-2175 or 800-344-3860 Toll Free USA/Canada  
**Fax:** 303-675-2176 or 800-344-3867 Toll Free USA/Canada  
**Email:** [orderlit@onsemi.com](mailto:orderlit@onsemi.com)

**N. American Technical Support:** 800-282-9855 Toll Free  
USA/Canada  
**Europe, Middle East and Africa Technical Support:**  
Phone: 421 33 790 2910  
**Japan Customer Focus Center**  
Phone: 81-3-5817-1050

**ON Semiconductor Website:** [www.onsemi.com](http://www.onsemi.com)  
**Order Literature:** <http://www.onsemi.com/orderlit>  
For additional information, please contact your local  
Sales Representative

# Mouser Electronics

Authorized Distributor

Click to View Pricing, Inventory, Delivery & Lifecycle Information:

[ON Semiconductor:](#)

[FAN7081MX\\_GF085](#) [FAN7081M\\_GF085](#)

## Данный компонент на территории Российской Федерации

### Вы можете приобрести в компании MosChip.

Для оперативного оформления запроса Вам необходимо перейти по данной ссылке:

<http://moschip.ru/get-element>

Вы можете разместить у нас заказ для любого Вашего проекта, будь то серийное производство или разработка единичного прибора.

В нашем ассортименте представлены ведущие мировые производители активных и пассивных электронных компонентов.

Нашей специализацией является поставка электронной компонентной базы двойного назначения, продукции таких производителей как XILINX, Intel (ex.ALTERA), Vicor, Microchip, Texas Instruments, Analog Devices, Mini-Circuits, Amphenol, Glenair.

Сотрудничество с глобальными дистрибьюторами электронных компонентов, предоставляет возможность заказывать и получать с международных складов практически любой перечень компонентов в оптимальные для Вас сроки.

На всех этапах разработки и производства наши партнеры могут получить квалифицированную поддержку опытных инженеров.

Система менеджмента качества компании отвечает требованиям в соответствии с ГОСТ Р ИСО 9001, ГОСТ РВ 0015-002 и ЭС РД 009

### Офис по работе с юридическими лицами:

105318, г.Москва, ул.Щербаковская д.3, офис 1107, 1118, ДЦ «Щербаковский»

Телефон: +7 495 668-12-70 (многоканальный)

Факс: +7 495 668-12-70 (доб.304)

E-mail: [info@moschip.ru](mailto:info@moschip.ru)

Skype отдела продаж:

moschip.ru

moschip.ru\_4

moschip.ru\_6

moschip.ru\_9