

Momentary action switch double pole



RI homogeneous blue



Point Illumination
green



non-illuminated
grey

See below:

[Approvals and Compliances](#)

Description

- Available in version Standard, lettered, with Point Illumination or Ring Illumination
- Assembly method: clip micro-switch into the saddle, secure switch using mounting nut
- Equipped with flat-pin plugs to permit fast connection

Characteristics

- Housing and actuating area material: high-quality stainless steel for use in harsh environments (see technical data)
- Variety of design options regarding size, colour, illumination, connection or lettering
- Switching voltage from 30 VDC to 250 VAC, switching current from 0.1 A to 10 A
- double pole version with two switching contact sets, can be wired as NO, NC or as change-over
- IP-Protection: IP67 from front side to contact area, Micro-Switch is available in versions IP40 or IP67

References

Alternative: switch with latching function: [MSM LA 19](#)

Alternative: switch with backlighted illumination: [MSM CS 19](#); [MSM CS 22](#)

Alternative: Other diameter

Alternative: Standard version [MSM DP 22](#); [MSM DP 30](#); [MSM 16](#); [MSM 30](#)

Weblinks

[pdf data sheet](#), [html datasheet](#), [General Product Information](#), [CAD-Drawings](#), [Product News](#), [Detailed request for product](#)

Technical Data**Electrical Data**

Switching Function	momentary
Number of Poles	DPDT
Supply Voltage	24 VDC Ring Illumination , LED operating data are listed in separate table 5 VDC and 12 VDC RI variants (except for RGB) on request (MOQ 500 pieces)
Impulse Withstand Voltage (ESD)	4 kV MSM ST / MSM LE

Micro Switch 5 A / 125 VAC or 3 A / 250 VAC, IP40

Contact Material	Ag
Switching Voltage	max. 125 / 250 VAC
Switching Current	max. 5 / 3 A
Rated Switching Capacity	750 W
Lifetime	0.2 million actuations at Rated Switching Capacity
Contact Resistance	< 30 mΩ
Insulation Resistance	> 100 MΩ
Duration of Bounce	< 5 ms

Micro Switch 0,1 A / 30 VDC, IP40

Contact Material	Au
Switching Voltage	max. 30 VDC
Switching Current	max. 0.1 A
Rated Switching Capacity	3 W
Lifetime	0.2 million actuations at Rated Switching Capacity
Contact Resistance	< 50 mΩ
Insulation Resistance	> 100 MΩ
Duration of Bounce	< 5 ms

Micro Switch for Electrical Rating 10 A / 250 VAC (Protection Class IP40)

Contact Material	Ag
Switching Voltage	max. 250 VAC
Switching Current	max. 10 A
Rated Switching Capacity	2500 W
Lifetime	0.2 million actuations at Rated Switching Capacity
Contact Resistance	< 30 mΩ
Insulation Resistance	> 100 MΩ
Duration of Bounce	< 5 ms

Micro Switch 6 A / 250 VAC, IP67

Switching Voltage	max. 250 VAC
Switching Current	max. 5
Rated Switching Capacity	1250 W
Lifetime	0.05 million actuations at Rated Switching Capacity

Micro Switch 0,1 A / 250 VAC, IP67 - on request

Switching Voltage	max. 250 VAC
Switching Current	max. 0.1
Rated Switching Capacity	25 W
Lifetime	0.05 million actuations at Rated Switching Capacity

Micro Switch 10 A / 250 VAC, IP67 - on request

Switching Voltage	max. 250 VAC
Switching Current	max. 10 A
Rated Switching Capacity	2500 W
Lifetime	0.01 million actuations at Rated Switching Capacity

Mechanical Data

Actuating Force	5.0 N
Actuating Travel	1.0 mm
Lifetime	1.5 million actuations
Shock Protection	IK 07
Mounting screw torque Plastic Nut	max. 4.5 Nm
Mounting screw torque Stainless Steel Nut	max. 12 Nm

Climatical Data

Operating Temperature	-25 to 85°C
Storage Temperature	-25 to 85°C
Protection Class	IP67
Salt Spray Test (acc. to DIN 50021-SS)	24 h / 48 h / 96 h Residence Time

Material

Housings	Stainless Steel
Actuator	Stainless Steel
Light Conductor (Point Illumination)	PC
Illuminated Ring (Ring Illumination)	PA for dotted single color variants PMMA for homogeneous single color variants
Seal Ring	NBR70
Switcher Collet	PA
Intermediate Connector non-illuminated	PA
Intermediate Connector illuminated	PA
Switcher Adapter	PA

Approvals and Compliances

Detailed information on product approvals, code requirements, usage instructions and detailed test conditions can be looked up in [Details about Approvals](#)

SCHURTER products are designed for use in industrial environments. They have approvals from independent testing bodies according to national and international standards. Products with specific characteristics and requirements such as required in the automotive sector according to IATF 16949, medical technology according to ISO 13485 or in the aerospace industry can be offered exclusively with customer-specific, individual agreements by SCHURTER.

Legend

B = Actuating Area
 C = Sealing
 D = Nut
 E = Anti-rotation protection
 F = Point illumination
 G = Illumination ring

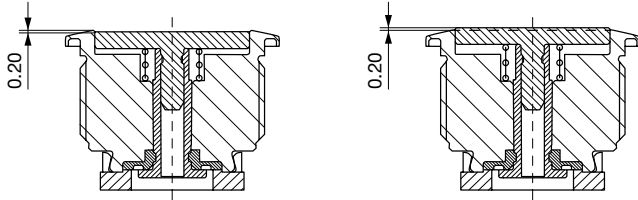
Tolerance Range**Actuator Tolerance Range**

The mounting tolerance range of the actuator varies from 0.2 mm projection length and 0.2 mm short length to the housing edge. The slanting position of the actuator can range within this tolerance.

The mounting tolerance range of the actuator varies from 0.2 mm projection length and 0.2 mm short length to the housing edge. The slanting position of the actuator can range within this tolerance.

Dimension

MSM 19 DP ST / MSM 19 DP RI

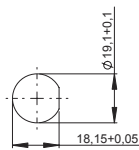
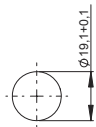
MSM 19 DP LE / MSM 19 DP PI /
MSM 19 DP RI optional

Drilling diagram

Drilling diagram

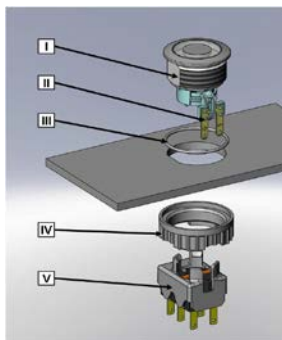
Assembly Instructions**I Housing****II Flat Pin Terminal (Illumination)****III Gasket****IV Nut (Nut type see Dimensions)****V Module Switching Contact**

Installation Instruction:

- 1.) Place the gasket accurately on the actuator housing. Then mount the actuator housing assembly into the panel.
- 2.) Tighten the screw nut according to the torque instructions.
- 3.) Clasp the module switching contact into the actuator housing.

Installation information:

- 1.) The power supply and the configuration of the flat pin terminals have to be installed correctly for the illumination and micro switch function.
- 2.) Insulate the terminals as required. Fully insulated plug-in sleeves are recommended.
- 3.) Installation instructions according to VDE-standard DIN VDE 0100-100 or alternatively IEC 60354 standard

Diagrams

MSM DP ST / MSM DP LE

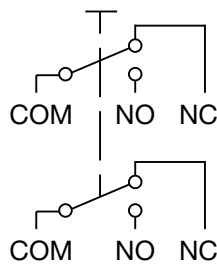

MSM DP PI

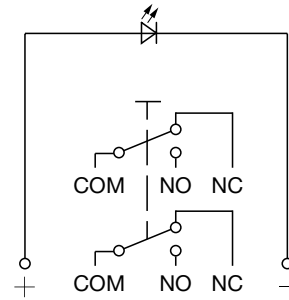

MSM DP RI

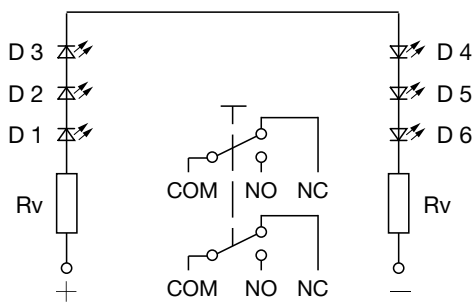

Point Illumination

Operating Data	Forward Current max.	Forward Voltage at 10 mA	Forward Voltage at 8 mA	Forward Voltage at 20 mA	Forward Voltage max.
LED red	30 mA	1.9 VDC			3.0 VDC
LED green	30 mA	2.1 VDC			3.0 VDC
LED yellow	30 mA	2.1 VDC			3.0 VDC
LED blue	20 mA		3.7 VDC		4.5 VDC
LED white	30 mA			3.6 VDC	4.0 VDC
LED red / green	25 mA			2.0 VDC / 2.2 VDC	

Attention: Switches are delivered without series resistor.

Lettering

The last three digits in the order number define the lettering:

000	No Lettering
001-074	Standard Lettering
101-	Customized Lettering

Lettering Colour of Laser Lettering

Material	Lettering Colour
Stainless Steel	black Filled letters

Order Index Lettering

Laser Marking			
001 =A	021 =U	041 =÷	061 =EIN
002 =B	022 =V	042 =*	062 =AUS
003 =C	023 =W	043 ==	063 =AUF
004 =D	024 =X	044 =#	064 =AB
005 =E	025 =Y	045 =↔	065 =ON
006 =F	026 =Z	046 =‡	066 =OFF
007 =G	027 =0	047 =→	067 =UP
008 =H	028 =1	048 =←	068 =DOWN
009 =I	029 =2	049 =↓	069 =HIGH
010 =J	030 =3	050 =↑	070 =LOW
011 =K	031 =4	051 =%	071 =ON/OFF
012 =L	032 =5	052 =√	072 =START
013 =M	033 =6	053 =CTRL	073 =RESET
014 =N	034 =7	054 =RETURN	074 =🔌
015 =O	035 =8	055 =SHIFT	075 =💡
016 =P	036 =9	056 =LOCK	076 =🔔
017 =Q	037 =+	057 =STOP	077 =Ⓜ
018 =R	038 =-	058 =ENTER	
019 =S	039 =.	059 =BACK	
020 =T	040 =x	060 =LINE	

All Variants

IP Switching Unit	Switching Current [A]	Switching Voltage [VAC/VDC]	Illumination, LED	Housing Material, Torsion Protection	Actuator Material, Tor- sion Protection	Config. Code	Order Number
IP40	5 / 3 A	125 / 250 VAC	non-illuminated	Stainless Steel ,no	Stainless Steel ,no	MSM 19 DP Pcs	1241.6921.1120000
IP40	5 / 3 A	125 / 250 VAC	non-illuminated	Stainless Steel ,yes	Stainless Steel ,yes	MSM 19 DP LE	1241.6922.1120000
IP40	5 / 3 A	125 / 250 VAC	Point Illumination, red	Stainless Steel ,yes	Stainless Steel ,yes	MSM 19 DP PI red	1241.6923.1121000
IP40	5 / 3 A	125 / 250 VAC	Point Illumination, green	Stainless Steel ,yes	Stainless Steel ,yes	MSM 19 DP PI green	1241.6923.1122000
IP40	5 / 3 A	125 / 250 VAC	Point Illumination, blue	Stainless Steel ,yes	Stainless Steel ,yes	MSM 19 DP PI blue	1241.6923.1124000
IP40	5 / 3 A	125 / 250 VAC	RI dotted, red, 24 VDC	Stainless Steel ,yes	Stainless Steel ,yes	MSM 19 DP RI red	1241.6924.1121000
IP40	5 / 3 A	125 / 250 VAC	RI dotted, green, 24 VDC	Stainless Steel ,yes	Stainless Steel ,yes	MSM 19 DP RI green	1241.6924.1122000
IP40	5 / 3 A	125 / 250 VAC	RI dotted, blue, 24 VDC	Stainless Steel ,yes	Stainless Steel ,yes	MSM 19 DP RI blue	1241.6924.1124000
IP40	5 / 3 A	125 / 250 VAC	RI homogeneous, red, 24 VDC	Stainless Steel ,yes	Stainless Steel ,yes	MSM 19 DP RI red	3-108-951
IP40	5 / 3 A	125 / 250 VAC	RI homogeneous, green, 24 VDC	Stainless Steel ,yes	Stainless Steel ,yes	MSM 19 DP RI green	3-108-962
IP40	5 / 3 A	125 / 250 VAC	RI homogeneous, blue, 24 VDC	Stainless Steel ,yes	Stainless Steel ,yes	MSM 19 DP RI blue	3-108-963

IP-Protection: IP67 from front side to contact area, Micro-Switch is available in versions IP40 or IP67, see Technical Data Micro-Switch

Variants with 6 A micro switch have IP67

The MOQ for standard laser lettering on standard variants is a packing unit.

5 VDC and 12 VDC RI variants (except for RGB) on request (MOQ 500 pieces)

Customer-specific versions available on request.

Special materials for use in salt and chlorinated environment on request.

The nut with gasket and micro switch are enclosed in the box.

Most Popular.

Availability for all products can be searched real-time: <https://www.schurter.com/en/Stock-Check/Stock-Check-SCHURTER>

Packaging unit 10 in box with insert or packed in air cushion bags



- Actuating elements in ESD safe packaging
- Screw nuts and sealing rings in a bag (enclosed in the box)
- Micro switches in a bag (enclosed in the box)

Accessories

Description



Power Supply

Power Supply IP42 for LED- and Illumination applications indoor 90~264 VAC => 24 VDC 0.34 A 8 W

Данный компонент на территории Российской Федерации

Вы можете приобрести в компании MosChip.

Для оперативного оформления запроса Вам необходимо перейти по данной ссылке:

<http://moschip.ru/get-element>

Вы можете разместить у нас заказ для любого Вашего проекта, будь то серийное производство или разработка единичного прибора.

В нашем ассортименте представлены ведущие мировые производители активных и пассивных электронных компонентов.

Нашей специализацией является поставка электронной компонентной базы двойного назначения, продукции таких производителей как XILINX, Intel (ex.ALTERA), Vicor, Microchip, Texas Instruments, Analog Devices, Mini-Circuits, Amphenol, Glenair.

Сотрудничество с глобальными дистрибьюторами электронных компонентов, предоставляет возможность заказывать и получать с международных складов практически любой перечень компонентов в оптимальные для Вас сроки.

На всех этапах разработки и производства наши партнеры могут получить квалифицированную поддержку опытных инженеров.

Система менеджмента качества компании отвечает требованиям в соответствии с ГОСТ Р ИСО 9001, ГОСТ РВ 0015-002 и ЭС РД 009

Офис по работе с юридическими лицами:

105318, г.Москва, ул.Щербаковская д.3, офис 1107, 1118, ДЦ «Щербаковский»

Телефон: +7 495 668-12-70 (многоканальный)

Факс: +7 495 668-12-70 (доб.304)

E-mail: info@moschip.ru

Skype отдела продаж:

moschip.ru

moschip.ru_4

moschip.ru_6

moschip.ru_9