

CONNECTOR SELECTION GUIDE (Continued)

**CONNECTORS FOR
PRINTED CIRCUIT BOARDS**

SHIELDED RIGHT ANGLE



EDBL25SBA1
ED* Series Page 17

**PIN AND SOCKET
RIGHT ANGLE**



DDP-50SAA
D*P Series Page 20

VERTICAL MOUNT



DBPF25 (P or S) Y4
D*PF Series Page 22

MILITARY/AEROSPACE

M24308 SOLDER CUP



DCMME37P
D*M Series Page 29

**M24308 PRINTED
CIRCUIT**



DCM-37PA
D*M Series Page 29

M24308 CRIMP



DAMAM15P
D*MA Series Page 39

M24308 HERMETIC



D*H Series Phoenix

**COAX/HIGH VOLT/
HIGH POWER**



DBM-17W2P
D*M Series Page 29

HIGH DENSITY



DDMA-78S-F0
D*MA Series Page 39

SPECIAL PURPOSE

DOUBLE-DENSITY



2D* Series Micro

CONNECTOR SAVER



DBBMA-25PS
D*BMA Series Page 50

**M24308 TYPE
ENVIRONMENTAL**



GDB-25P
GD* Series Page 46

**DIE-CAST
ENVIRONMENTAL**



D*D Series Page 51

ORIGINAL-D

The Original-D, Cannon's low cost general-purpose D Subminiature, features solder cup, P.C., or wrap post contacts available in 9, 15, 25, 37, and 50 contact arrangements. Cannon's Original-D utilizes a rugged machined contact captivated in a two-piece insulator.



HOW TO ORDER

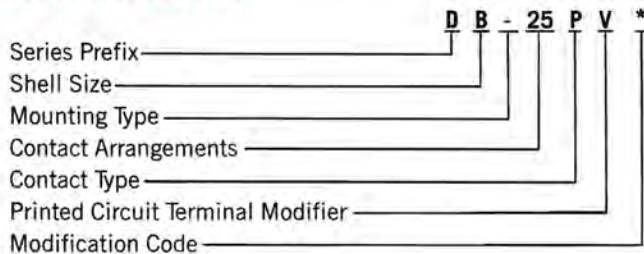

SERIES PREFIX

D

SHELL SIZE

E, A, B, C, D

MOUNTING TYPE

- No designator—Standard .120 (3.05) diameter mounting hole
- E — 4-40 clinch nut for rear panel mounting
- F — Float mount for rear panel mounting
- K — .154 (3.91) diameter mounting hole
- R — Reverse float mount for front panel mounting
- Y — Dual float mount for both front and rear panel mounting

CONTACT ARRANGEMENTS

9, 15, 25, 37, 50

CONTACT TYPE

P — Pin; S — Socket

PRINTED CIRCUIT TERMINAL MODIFIER

No designator—Solder cup contacts (standard)

- A — Right angle, .040 (1.02) diameter terminals with bracket; .093 (2.36) extension below bracket
- C — Same as A except less bracket
- H — Straight P.C. .040 (1.02) diameter, .156 (3.96) extension
- U — Straight P.C. .024 (0.61) diameter, .125 (3.17) extension
- V — Straight P.C. .040 (1.02) diameter, .093 (2.35) extension

MODIFICATION CODE

- Wire Wrapping Applications
 - F179— .024 (0.61) sq post, .375 (9.52) extension
 - F179A— .024 (0.61) sq post, .500 (12.70) extension
 - C53— UL 94V-0 rated polyamide insulator, color black
- See pg. 66 for additional modifications

STANDARD DATA

MATERIALS AND FINISHES

	Material	Finish
Shell	Steel	Yellow chromate over cadmium
Insulator	Two piece white nylon	—
Contacts	Copper alloy	Gold over nickel
Float Mount Hardware	Stainless steel	Passivated

MECHANICAL FEATURES

- Coupling— Friction and lock accessories
- Polarization— Keystone-shaped shells

PERFORMANCE SPECIFICATIONS

- Temperature Rating— -55°C to +120°C
- Dielectric Withstanding Voltage— 1250 VAC sea level
- Wire/Contact Size— #20 AWG
- Current Rating— #20 contact 5 Amps

CONTACT ARRANGEMENTS (Face View Pin Insert)

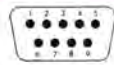

Shell Size
Contact Arrangement
Contact Size

E
9
#20

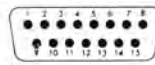

A
15
#20

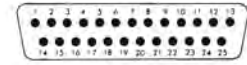

B
25
#20

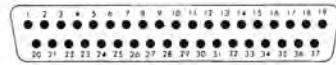

Shell Size
Contact Arrangement
Contact Size

C
37
#20

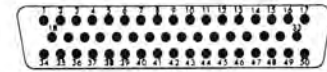

D
50
#20

PRINTED CIRCUIT APPLICATIONS

RIGHT ANGLE 90° TERMINAL

Connectors are furnished with or without a bracket.

Part Number Printed Circuit Terminal Modifier	90° Bracket Included
A	Yes
C	No

Example: DE-9PA, see page 4 for ordering nomenclature.

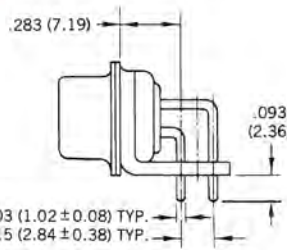

DE, DA, DB, DC SIZES

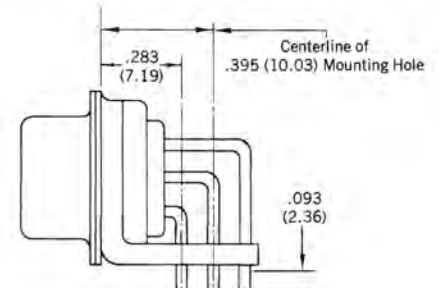

DO SIZE

STRAIGHT TERMINAL

Part Number Printed Circuit Terminal Modifier	X Nominal	Y ± .003 (± 0.08)
H	.156 (3.96)	.040 (1.02)
U	.125 (3.18)	.024 (0.61)
V	.093 (2.36)	.040 (1.02)

Example: DE-9PV, see page 4 for ordering nomenclature.

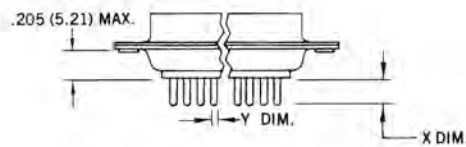

WIRE WRAPPING APPLICATIONS

Modification Code	H	W	Wrap Accommodations
F179	.587 (14.91)	.375 (9.52)	2
F179A	.713 (18.11)	.500 (12.7)	3

.024 (0.61) square contact tails will accommodate #28 or #30 AWG rigid wire (diagonal of square is .034/.031 (0.86/0.79)).

Example: DE-9P-F179A. See page 4 for ordering nomenclature.

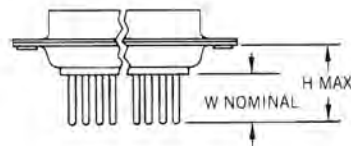

STANDARD SHELL

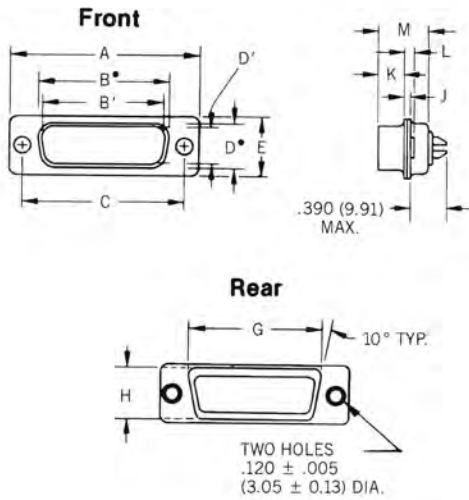

SHELL WITH FLOAT MOUNTS

(For shell with float mounts add letter F: e.g., DEF9P)

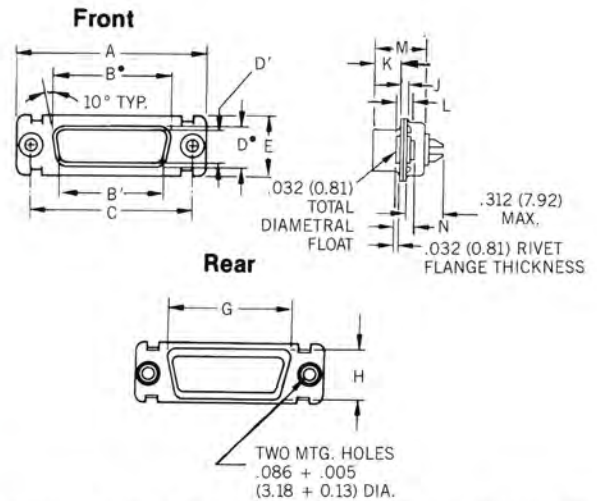

It is recommended that only one assembly, either pin or socket, be float mounted. For front panel mounting use reverse float mount; see page 65.

INCHES

Part Number by Shell Size	A ± .015	B• ± .010	B' ± .010	C ± .005	D• ± .010	D' ± .010	E ± .015	G• ± .010	H• ± .010	J ± .010	K ± .010	L ± .010	M ± .015	N ± .010
DE-9P	1.213	—	.666	.984	—	.329	.494	.759	.422	.030	.236	.045	.422	.120
DE-9S	1.213	.640	—	.984	.308	—	.494	.759	.422	.030	.243	.045	.429	.120
DA-15P	1.541	—	.994	1.312	—	.329	.494	1.083	.422	.030	.236	.045	.422	.120
DA-15S	1.541	.968	—	1.312	.308	—	.494	1.083	.422	.030	.243	.045	.429	.120
DB-25P	2.088	—	1.534	1.852	—	.329	.494	1.625	.422	.039	.231	.060	.426	.129
DB-25S	2.088	1.508	—	1.852	.308	—	.494	1.625	.422	.030	.243	.045	.429	.120
DC-37P	2.729	—	2.182	2.500	—	.329	.494	2.272	.422	.039	.231	.060	.426	.129
DC-37S	2.729	2.156	—	2.500	.308	—	.494	2.272	.422	.030	.243	.045	.429	.120
DD-50P	2.635	—	2.079	2.406	—	.436	.605	2.178	.534	.039	.231	.060	.426	.129
DD-50S	2.635	2.062	—	2.406	.420	—	.605	2.178	.534	.030	.243	.045	.429	.120

MILLIMETERS

Part Number by Shell Size	A ± 0.38	B• ± 0.25	B' ± 0.25	C ± 0.12	D• ± 0.25	D' ± 0.25	E ± 0.38	G• ± 0.25	H• ± 0.25	J ± 0.25	K ± 0.25	L ± 0.25	M ± 0.38	N ± 0.25
DE-9P	30.81	—	16.91	24.99	—	8.36	12.55	19.28	10.72	0.76	5.99	1.14	10.72	3.05
DE-9S	30.81	16.25	—	24.99	7.82	—	12.55	19.28	10.72	0.76	6.17	1.14	10.90	3.05
DA-15P	39.14	—	25.24	33.32	—	8.36	12.55	27.51	10.72	0.76	5.99	1.14	10.72	3.05
DA-15S	39.14	24.58	—	33.32	7.82	—	12.55	27.51	10.72	0.76	6.17	1.14	10.90	3.05
DB-25P	53.03	—	38.96	47.04	—	8.36	12.55	41.27	10.72	0.99	5.87	1.52	10.82	3.28
DB-25S	53.03	38.30	—	47.04	7.82	—	12.55	41.27	10.72	0.76	6.17	1.14	10.90	3.05
DC-37P	69.31	—	55.42	63.50	—	8.36	12.55	57.71	10.72	0.99	5.87	1.52	10.82	3.28
DC-37S	69.31	54.76	—	63.50	7.82	—	12.55	57.71	10.72	0.76	6.17	1.14	10.90	3.05
DD-50P	66.92	—	52.81	61.11	—	11.07	15.37	55.32	13.56	0.99	5.87	1.52	10.82	3.28
DD-50S	66.92	52.37	—	61.11	10.67	—	15.37	55.32	13.56	0.76	6.17	1.14	10.90	3.05

• Dimensions B, D, G, and H are measured as outside dimensions at the bottom of draw.
NOTE: B• and D• are the O.D. dims. for socket side, B' and D' are the I.D. dims. for pin side.

BURGUN-D D*C/D*U

The BURGUN-D Series, Cannon's low cost crimp-type D Sub-miniature, offers both machined and stamped contacts for crimp and printed circuit applications. Available in UL 94V-0 material, the D*C/D*U Series features a snap-in, rear-release contact and is widely used for commercial cabling and P.C. board applications. For high volume crimp applications connectors are purchased less contacts (code "FO"), and stamped contacts on reels are purchased in bulk for use with Cannon's high-speed crimping equipment.

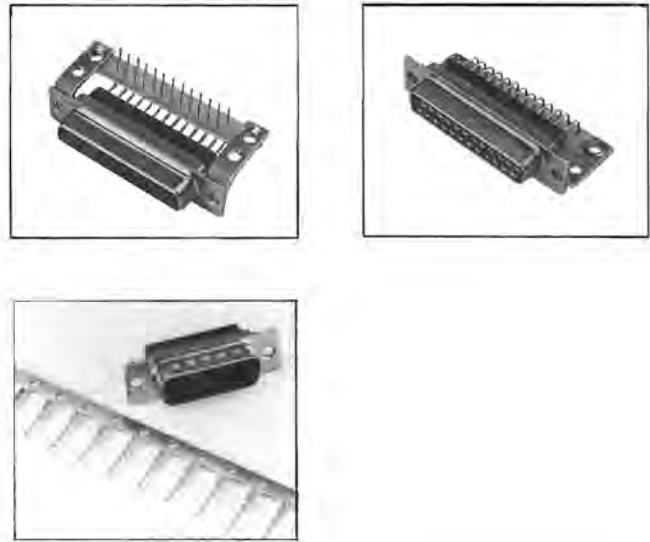

REAR RELEASE CONTACT RETENTION ASSEMBLY

The D*C and D*U connectors feature a rear insulator with integral, molded contact retaining tines. These plastic tines permit the insertion and extraction of contacts from the rear of the connector with a simple, expendable plastic insertion/extraction tool.

During contact insertion, the retaining tines expand as the contact passes thru. These rugged tines snap into place behind the contact shoulder when the contact is fully inserted. The tool is inserted to expand the tines, allowing easy extraction of the wired contact.

The retention system and the integral contact retaining tines guarantee functional reliability in many environments.

- Mates with existing D types
- Operates in temperatures to + 125 °C
- Crimp snap-in contacts
- Highly reliable socket contacts
- Insertion/extraction with expendable tool
- Corrects misaligned contacts

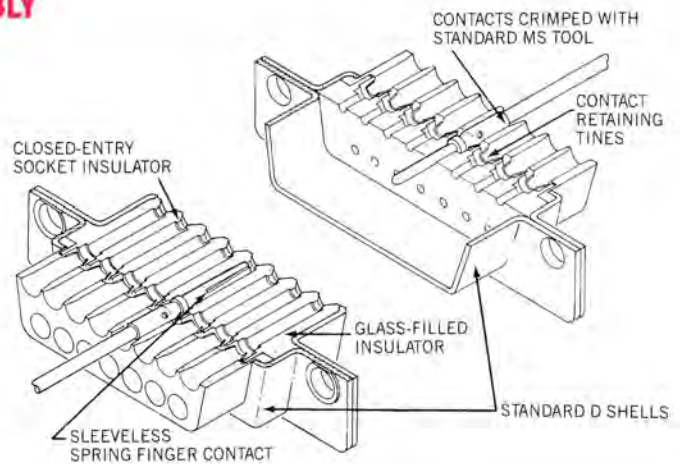

STANDARD DATA

MATERIALS AND FINISHES

	Material	Finish
Shell	Steel	Yellow chromate over cadmium
Insulator	D*C: Thermoplastic, Glass-filled, color red	
	D*U: UL 94V-0 rated Thermoplastic, Glass-filled, color black	
Contacts	Machined	Copper alloy
	Stamped and Formed	Copper alloy
	Crimp Type	
	Stamped and Formed	Copper alloy
P.C. Type		Gold over nickel engaging end, tin/lead terminal end
Float Mount Hardware	Stainless Steel	Passivated

MECHANICAL FEATURES

Coupling—Friction and lock accessories
Polarization—Keystone-shaped shells

PERFORMANCE SPECIFICATIONS

Wire Size—See contact ordering information.
Current Rating—#20 contact, 5 Amps
Voltage Rating—1000 VAC sea level
Temperature Rating— - 65 °C to + 125 °C

HOW TO ORDER

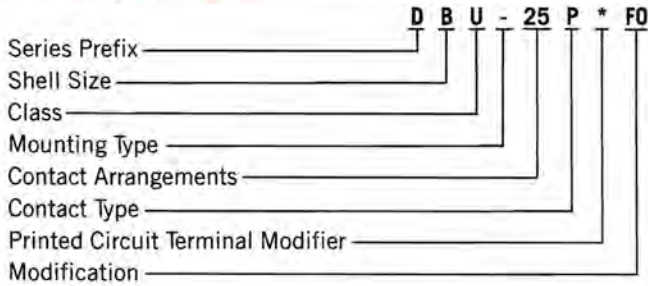

SERIES PREFIX

D — ITT Cannon designation

SHELL SIZE

E, A, B, C and D

CLASS

C — Contact retaining tines, BURGUN-D insulator
U — Contact retaining tines, UL 94V-O rated black insulator

MOUNTING TYPE

No designator — standard .120 (3.05) diameter mounting holes
E — 4-40 clinch nut for rear panel mounting
F — Float mount for rear panel mounting
K — .154 (3.91) diameter mounting hole
R — Reverse float mount for front panel mounting
Y — Dual float mount for both front and rear panel mounting

CONTACT ARRANGEMENTS

3, 5, 9, 15, 25, 37 and 50

CONTACT TYPE

P — Pin; S — Socket

PRINTED CIRCUIT TERMINAL MODIFIER

Right Angle Terminal

AA — Stamped contacts with bracket—.030/.026 (0.76/0.66) dia. with .164/.149 (4.16/3.78) extension from bracket
AD — Machined contacts with bracket—.026/.022 (0.66/0.56) dia. with .164/.149 (4.16/3.78) extension from bracket
CA — Stamped contacts with metal bracket—.030/.026 (0.76/0.66) dia. with .164/.149 (4.16/3.78) extension from bracket

Straight Terminal

BB — Stamped contacts—.030/.026 (0.76/0.66) dia. with .159/.129 (4.04/3.28) extension from rear of insulator
BF — Machined contacts—.026/.022 (0.66/0.56) dia. with .159/.129 (4.04/3.28) extension from rear of insulator

MODIFICATION

A197 — Tin plated shells
K87 — Tin plated shells with grounding indents for EMI/RFI supression (pin connectors only)
FO — Connector less contacts (not stamped on connector)
See page 66 for additional modifications.

CONTACT ARRANGEMENTS (Face View Pin Insert)



Shell Size **E**
Contact Arrangement **3**
Contact Size **#20**

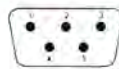

Shell Size **E**
Contact Arrangement **5**
Contact Size **#20**

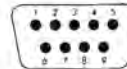

Shell Size **E**
Contact Arrangement **9**
Contact Size **#20**

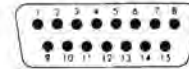

Shell Size **A**
Contact Arrangement **15**
Contact Size **#20**

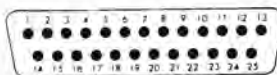

Shell Size **B**
Contact Arrangement **25**
Contact Size **#20**

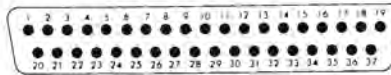

Shell Size **C**
Contact Arrangement **37**
Contact Size **#20**

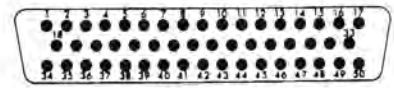

Shell Size **D**
Contact Arrangement **50**
Contact Size **#20**

STANDARD SHELL

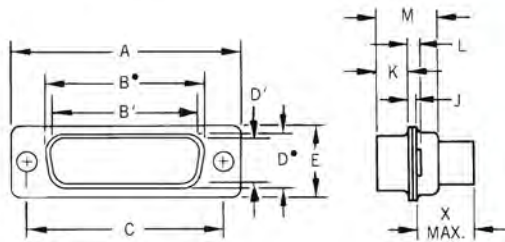

Front

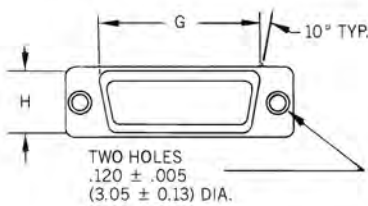

Rear

SHELL WITH FLOAT MOUNTS

(For shell with float mounts add letter F: e.g., DEC F9P)

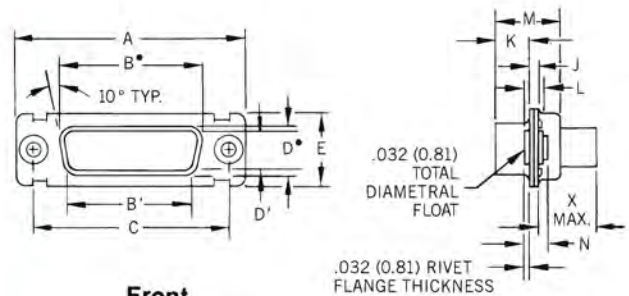

Front

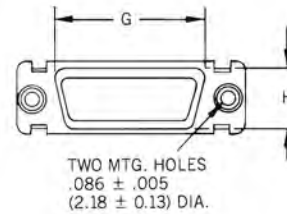

Rear

It is recommended that only one assembly, either pin or socket, be float mounted. For front panel mounting use reverse float mount; see page 65.

INCHES

Part Number by Shell Size	A ±.015	B ±.010	B' ±.010	C ±.005	D ±.010	D' ±.010	E ±.015	G ±.010	H ±.010	J ±.010	K ±.010	L ±.010	M ±.015	N ±.010	X Max.
DEC-9P	1.213	—	.666	.984	—	.329	.494	.759	.422	.030	.236	.045	.422	.120	.375
DEC-9S	1.213	.640	—	.984	.308	—	.494	.759	.422	.030	.243	.045	.429	.120	.375
DAC-15P	1.541	—	.994	1.312	—	.329	.494	1.083	.422	.030	.236	.045	.422	.120	.375
DAC-15S	1.541	.968	—	1.312	.308	—	.494	1.083	.422	.030	.243	.045	.429	.120	.375
DBC-25P	2.088	—	1.534	1.852	—	.329	.494	1.625	.422	.039	.231	.060	.426	.129	.375
DBC-25S	2.088	1.508	—	1.852	.308	—	.494	1.625	.422	.030	.243	.045	.429	.120	.375
DCC-37P	2.729	—	2.182	2.500	—	.329	.494	2.272	.422	.039	.231	.060	.426	.129	.375
DCC-37S	2.729	2.156	—	2.500	.308	—	.494	2.272	.422	.030	.243	.045	.429	.120	.375
DDC-50P	2.635	—	2.079	2.406	—	.436	.605	2.178	.534	.039	.231	.060	.426	.129	.375
DDC-50S	2.635	2.062	—	2.406	.420	—	.605	2.178	.534	.030	.243	.045	.429	.120	.375

MILLIMETERS

Part Number by Shell Size	A ±0.38	B ±0.25	B' ±0.25	C ±0.12	D ±0.25	D' ±0.25	E ±0.38	G ±0.25	H ±0.25	J ±0.25	K ±0.25	L ±0.25	M ±0.38	N ±0.25	X Max.
DEC-9P	30.81	—	16.91	24.99	—	8.36	12.55	19.28	10.72	0.76	5.99	1.14	10.72	3.05	9.52
DEC-9S	30.81	16.25	—	24.99	7.82	—	12.55	19.28	10.72	0.76	6.17	1.14	10.90	3.05	9.52
DAC-15P	39.14	—	25.24	33.32	—	8.36	12.55	27.51	10.72	0.76	5.99	1.14	10.72	3.05	9.52
DAC-15S	39.14	24.58	—	33.32	7.82	—	12.55	27.51	10.72	0.76	6.17	1.14	10.90	3.05	9.52
DBC-25P	53.03	—	38.96	47.04	—	8.36	12.55	41.27	10.72	0.99	5.87	1.52	10.82	3.28	9.52
DBC-25S	53.03	38.30	—	47.04	7.82	—	12.55	41.27	10.72	0.76	6.17	1.14	10.90	3.05	9.52
DCC-37P	69.31	—	55.42	63.50	—	8.36	12.55	57.71	10.72	0.99	5.87	1.52	10.82	3.28	9.52
DCC-37S	69.31	54.76	—	63.50	7.82	—	12.55	57.71	10.72	0.76	6.17	1.14	10.90	3.05	9.52
DDC-50P	66.92	—	52.81	61.11	—	11.07	15.37	55.32	13.56	0.99	5.87	1.52	10.82	3.28	9.52
DDC-50S	66.92	52.37	—	61.11	10.67	—	15.37	55.32	13.56	0.76	6.17	1.14	10.90	3.05	9.52

• Dimensions B, D, G, and H are measured as outside dimensions at the bottom of the draw.
NOTE: B • and D • are the O.D. dims. for socket side, B' and D' are the I.D. dims. for pin side.

STAMPED CRIMP CONTACTS

Stamped contacts are furnished on reels for use with the semi-automatic crimp and strip/crimp machines. These contacts will accommodate wire sizes #18 thru #32 AWG stranded wire.

NON-INSULATION SUPPORT

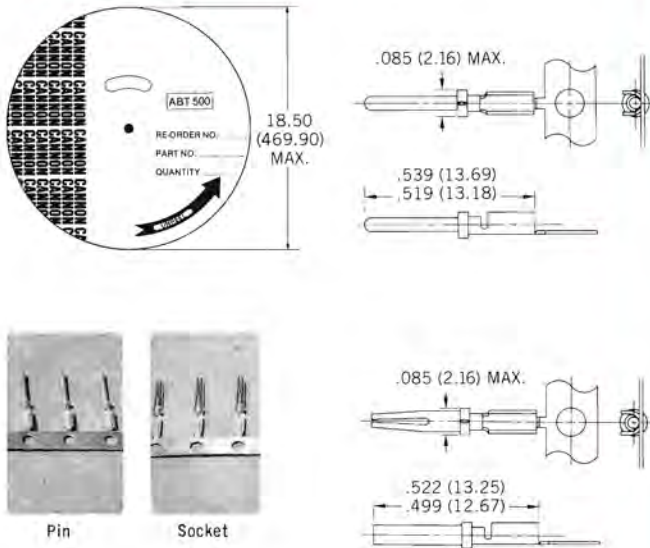

Contact Size	Wire Accommodation	Contact Part Number		Contacts Per Reel
		Pin	Socket	
20-18	AWG #18 thru 22 (For AWG #24 consult factory)	D110238-165	D110238-166	7,500
20	AWG #20 thru 28 (For AWG #30 consult factory)	D110238-34	D110238-35	10,000

INSULATION SUPPORT

Wire Accommodation	Contact Part Number		Contact Per Reel
	Pin	Socket	
AWG #22-#26	J110238-428	D110238-434	7,500
AWG #28 thru #32	D110238-431	D110238-436	7,500

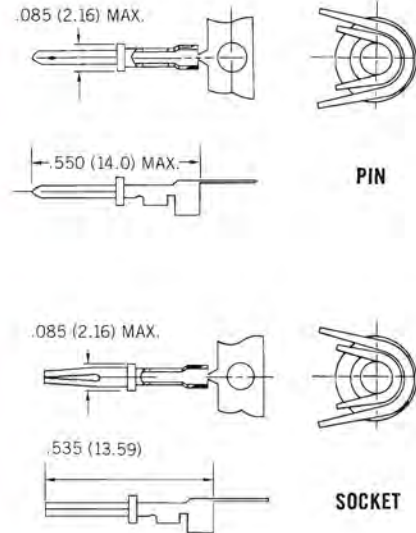

MACHINED CRIMP CONTACTS

Machined contacts are furnished loose piece for use with manual and semi-automatic machines.

NOTE for Size 20-18 contacts only: Shrink sleeving is suggested on the crimp pot to prevent contacts from touching.



Description	Part Number	Wire Accommodation	A ±.002 (±0.05)	B ±.002 (±0.05)	C Max.
Pin 20	030-1952-000	20, 22, 24	.067(1.70)	.045(1.14)	.537(13.64)
Pin 20-18	030-1954-000	(1) 18 or (2) #22	.086(2.18)	.066(1.68)	.874(22.20)
Pin 20-26	030-1952-002	26, 28, 30	.067(1.70)	.025(0.63)	.537(13.64)
Socket 20	030-1953-000	20, 22, 24	.067(1.70)	.045(1.14)	.523(13.28)
Socket 20-18	030-1955-000	(1) 18 or (2) #22	.086(2.18)	.066(1.68)	.852(21.64)
Socket 20-26	030-1953-002	26, 28, 30	.067(1.70)	.025(0.63)	.523(13.28)

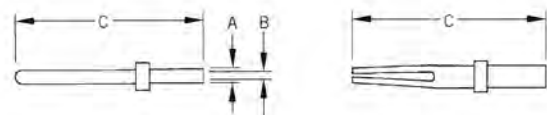

CONTACT CRIMPING

A full range of manual to fully automatic crimp equipment is available from Cannon to meet all volume requirements.

Machined contact needs are met by Mil standard hand crimp tools for low volumes. For volume applications the CBT-491 is a pneumatically operated, vibra-bowl crimper offering a more economical approach than belt-fed contacts.

For low volume **stamped contact** applications CCT type hand tools deliver a reliable crimp with minimal expense. For higher volumes the pneumatically operated ABT-607 is available for lease. For maximum savings the ABT-500 stripper and crimper uses stamped reeled contacts and terminates in one easy operation. Our newest machine the ABT-620 is also designed for highest volume lowest installed cost applications. When you think crimp, think Cannon!



995-0002-206
995-0002-207



CCT-D * C-1



CBT-491



ABT-620



ABT-500

SEMI-AUTOMATIC TOOLING

Contact Type	Volume	Contact Size	Tool Part No.	Lease/Purchase
Machined	Low/Medium	All	CBT-565	Purchase
	High Volume	All	CBT-491	Both
Stamped	Low Volume	All	CPT-D * C	Purchase
	Medium/High	All	ABT-607	Lease
	High	All	ABT-500	Lease
			ABT-620	Lease

HAND TOOLS

Contact Type	Contact Size	Wire Accommodation	Hand Tool Part No.	Hand Tool Description
Machined	20	20, 22, 24	995-0002-206	CCT-DCM-1
			995-0002-207	CCT-DCM-2
	20-18	1 #18, 2 #22	995-0002-206	CCT-DCM-1
	20-26	26, 28, 30	995-0002-207	CCT-DCM-2
Stamped	20	20-28	995-0001-662	CCT-D * C-1
	20-18	18, 20, 2 #22	995-0001-870	CCT-D * C-4
Stamped Insulation Support	All	All	995-0002-107	CCT-D * C-10



CPT-D * C



CBT-565

INSERTION/EXTRACTION TOOLS

Contact Type	Contact Size	Wire Accommodation	Plastic Insertion/Extraction		Metal Extraction	
			Part No.	Description	Part No.	Description
Machined	20	20, 22, 24	274-7006-000	CIET-20HD	995-0001-695	CET-20D
	20-18	1 #18, 2 #22	274-5016-002	CET-20-15	995-0001-695	CET-20D
	20-26	26, 28, 30	274-7006-000	CIET-20HD	995-0001-695	CET-20D
Stamped	All	20-32	274-7006-000	CIET-20HD	995-0001-695	CET-20D
Stamped	20-18	#18	Not Available		995-0001-695	CET-20D



ABT-607



CET-20D



CIET-20HD

ASSEMBLY OF BURGUN-D D*C/D*U

**WIRE STRIPPING—
MACHINED CONTACTS**

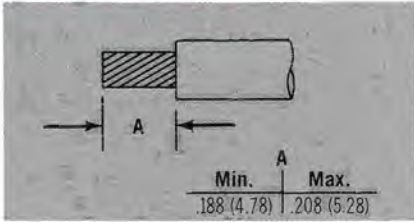

1. Cut wires to length. Strip insulation per above illustration. Check for broken or frayed wires.

CONTACT CRIMPING



2. Insert contact and wire into proper crimp tool (and locator, if required). Crimp contact to wire. Inspect crimp.

CONTACT INSERTION



3. Center wired contact in groove of insertion tool with tool tip butting contact shoulder. Insert contact into cavity until a positive stop is felt. Inspect insertion.

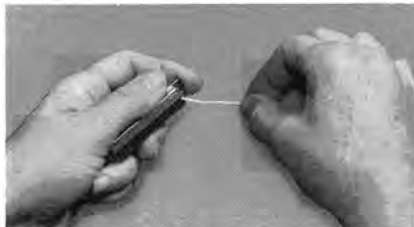

4. To be sure contact is locked securely, pull back lightly on wire. Repeat for balance of contacts working row by row across the insulator.



5. Place wire into extraction tool tip.



6. Insert tool tip into contact cavity until tip bottoms against contact shoulder, releasing tines. Hold wire against tool with finger and remove tool and contact. Repeat for balance of contacts.

STRAIGHT PRINTED CIRCUIT CONTACTS

MACHINED CONTACTS can be ordered either installed in the connector or connectors and contacts may be ordered separately.

CODE BF: Connectors with contacts installed
Typical Part No. DBU-25P-BF.

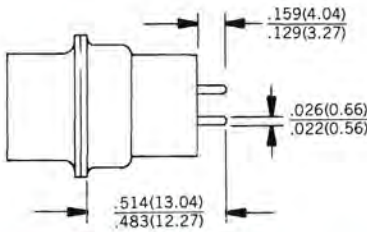

Part numbers for ordering contacts separately:

STRAIGHT MACHINED CONTACTS

	Contact Part Number	A ± .010 (± 0.25)	†C ± .002 (0.51) Dia. Type.
Pin	030-1989-000	.730 (18.5)	.024 (0.61)
Socket	030-1990-000	.710 (18.0)	.024 (0.61)

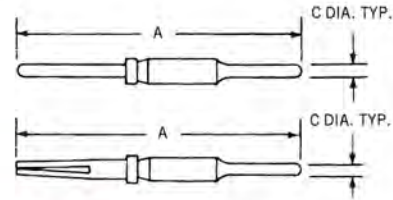

STAMPED CONTACTS are factory-installed in connectors and cannot be ordered separately.

CODE BB: Typical Part Number: DBU-25S-BB

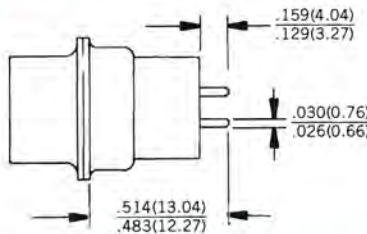

90° PRINTED CIRCUIT CONTACTS

MACHINED CONTACTS can be ordered either installed in connectors or in bulk.

CODE AD: Connectors with contacts installed and are supplied with plastic mounting bracket Typical Part Number: DBU-25S-AD

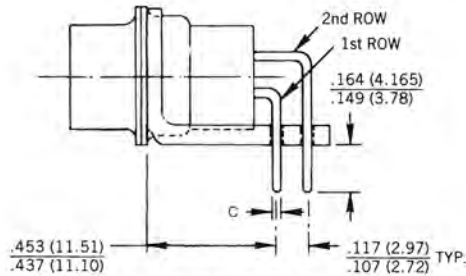

DE, DA, DB, DC SIZES

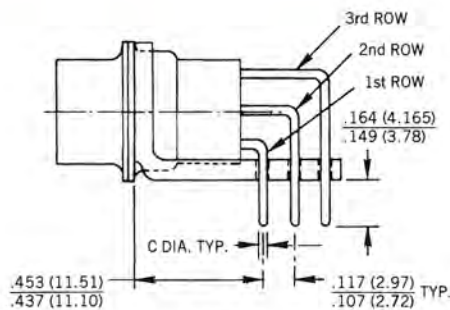

DD SIZE

Plastic Bracket Dimensions and Material: See page 62
Board Layout: See page 63
Connectors are fully assembled

90° MACHINED CONTACTS

	Row	Contact Part Number	A	B	C ± .002(0.51) Dia. Typ.
Pin	1st	030-2086-000	.684(17.37)	.345(8.76)	.024(0.61)
*Pin	2nd	030-2087-000	.796(20.21)	.457(11.61)	.024(0.61)
**Pin	3rd	030-2088-000	.908(23.06)	.569(14.45)	.024(0.61)
Socket	1st	030-2089-000	.666(16.92)	.345(8.76)	.024(0.61)
*Socket	2nd	030-2090-000	.778(19.76)	.457(11.61)	.024(0.61)
**Socket	3rd	030-2091-000	.890(22.61)	.569(14.45)	.024(0.61)

*2nd row for shell sizes E, A, B and C starting from cavity 1.
**3rd row for shell size D only, starting from cavity 1.

LOOSE CONTACTS

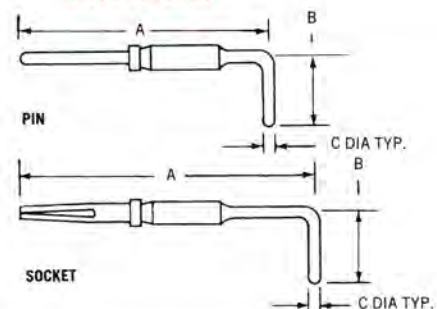

90° PRINTED CIRCUIT CONTACTS (CON'T)

STAMPED CONTACTS are factory installed in connectors and cannot be ordered separately.

CODE AA: PLASTIC BRACKET

Connectors come with contacts installed and are supplied with plastic mounting bracket.
Typical Part Number: DCU-37P-AA

Board Layout: See page 63
Bracket Dimensions and Material: See page 62

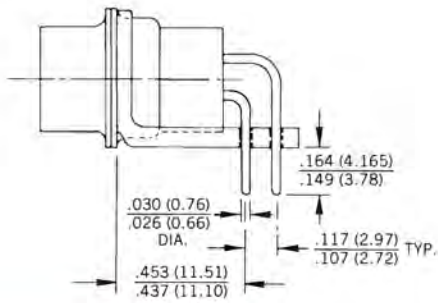

DE, DA, DB, DC SIZES

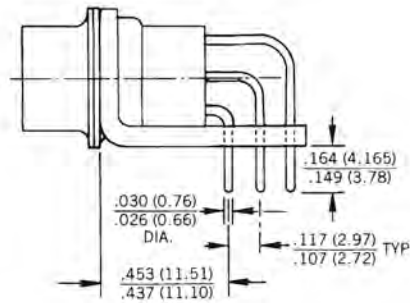

DD SIZE

CODE AA-F202: METAL BRACKET

Connectors come with contacts installed and are supplied with a metal bracket.
Typical Part Number: DAU-15S-AA-F202.

Bracket Material: Zinc, tin-plated
Board Layout: See page 63
Consult factory for DD-50 layout

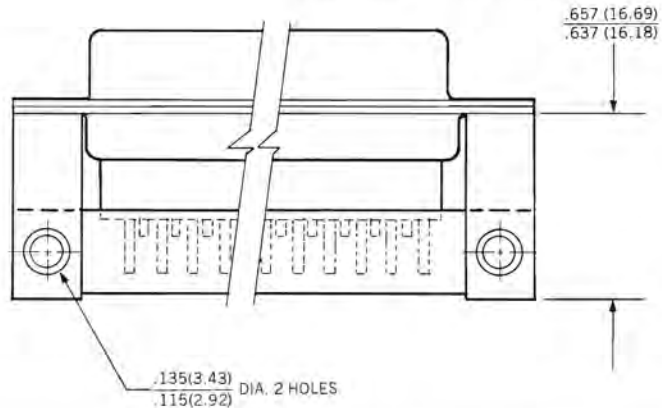
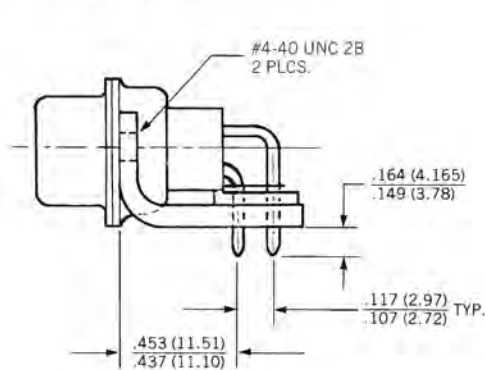

CODE CA: METAL BRACKET

Connectors come with contacts installed and are supplied with metal bracket.
Typical Part Number: DEU-9P-CA

Bracket Material: Zinc, tin-plated
Board Layout: See page 63
Consult factory for DD-50 layout

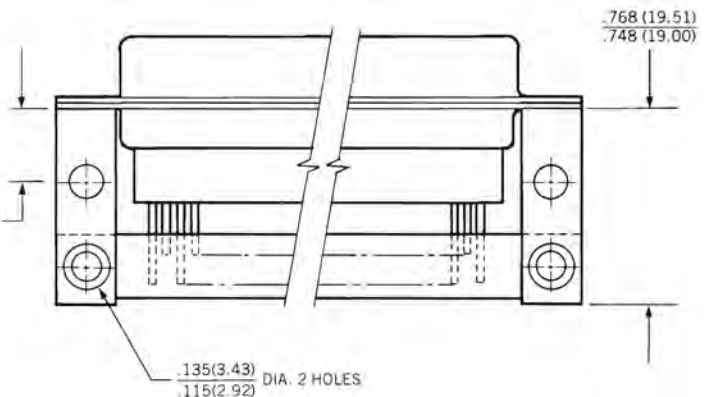
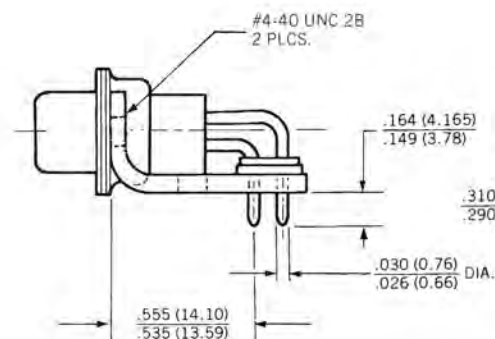

SPEEDY D SERIES

ITT Cannon has developed the Speedy D to allow reliable, fast, and economical termination of #26 and #28 AWG ribbon cable with .050 (1.27) centers. These connectors are available with 9, 15, 25, and 37 contacts and are intermateable with all D Subminiature connectors.

Termination is accomplished by inserting the cable into the integral cable locator/termination cap, and pressing the cap into place.

Speedy-D connectors will also accommodate daisy-chain applications.

- No splitting of ribbon cable
- Optional strain relief
- Metal shell
- Integral termination cap
- Low profile



HOW TO ORDER

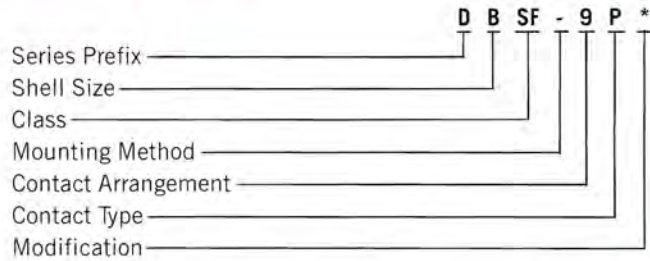

SERIES PREFIX

D — ITT Cannon Designation

SHELL SIZE

- E — 9 contacts
- A — 15 contacts
- B — 25 contacts
- C — 37 contacts

CLASS

SF — V-Crimp

MOUNTING METHOD

- Without designation — two through-holes .120 (3.05mm)
- Y — Float mounting

CONTACT ARRANGEMENTS

9, 15, 25, 37 contacts

CONTACT TYPE

- P — Pin
- S — Socket

MODIFICATION

- A197 — Tin plated shell
- G — All plastic construction (consult factory for availability)
- K87 — Tin plated shell with grounding indents for EMI/RFI protection

STANDARD DATA

MATERIALS AND FINISHES

	Material	Finish
Shell	Steel	Yellow chromate coat over zinc
Insulator	Polyester G.F., Black, UL94V-0 rated	—
Contacts	Copper alloy (CuBe)	Contact area gold-plated on nickel termination area tinned other finishes upon request.

MECHANICAL FEATURES

- Coupling—Friction, accessories
- Polarization—Keystone shaped shells
- Termination—IDC
- Wire Size—AWG 26-28, stranded or solid
- Cable—Ribbon cable, conductor spacing .050 (1.27)

PERFORMANCE SPECIFICATIONS

- Current Rating—1 Amp
- Operating Voltage—750 V rms
- Insulation Resistance—1000 megohms, min.
- Contact Resistance—15 milliohms, max.

ACCESSORIES

Shell Size	Strain Relief
E	029-8757-009
A	029-8757-015
B	029-8757-025
C	029-8757-037

CONTACT ARRANGEMENTS (Face View Pin Insert)

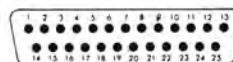
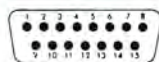
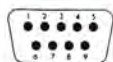

Shell Size
Contact Arrangement
Contact Size

E
9
#20

A
15
#20

B
25
#20

C
37
#20

DIMENSIONAL DATA

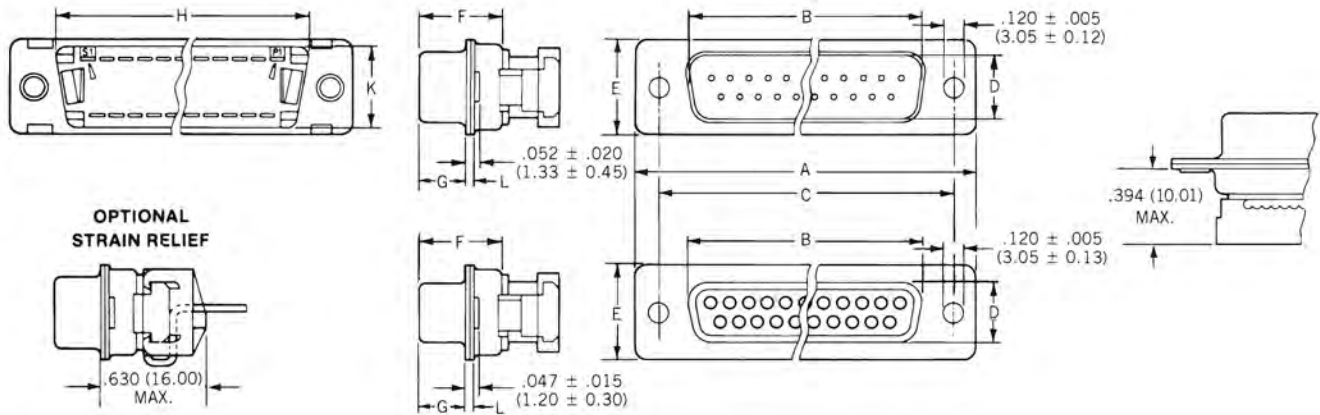

INCHES

Part Number by Shell Size	A ± .015	B ± .005	C ± .005	D ± .005	E ± .015	F ± .010	G ± .010	H ± .010	K ± .005	L ± .010
DESF-9P	1.213	.666	.984	.329	.494	.422	.235	.759	.433	.030
DESF-9S	1.213	.643	.984	.311	.494	.429	.243	.759	.433	.030
DASF-15P	1.541	.994	1.312	.329	.494	.422	.235	1.083	.433	.030
DASF-15S	1.541	.971	1.312	.311	.494	.429	.243	1.083	.433	.030
DBSF-25P	2.088	1.534	1.852	.329	.494	.426	.235	1.625	.433	.039
DBSF-25S	2.088	1.509	1.852	.311	.494	.429	.243	1.625	.433	.030
DCSF-37P	2.729	2.182	2.500	.329	.494	.426	.235	2.272	.433	.039
DCSF-37S	2.729	2.159	2.500	.311	.494	.429	.243	2.272	.433	.030

MILLIMETERS

Part Number by Shell Size	A ± 0.38	B ± 0.12	C ± 0.12	D ± 0.12	E ± 0.38	F ± 0.25	G ± 0.25	H ± 0.25	K ± 0.12	L ± 0.25
DESF-9P	30.81	16.91	24.99	8.35	12.55	10.71	5.97	19.27	11.0	0.76
DESF-9S	30.81	16.33	24.99	7.90	12.55	10.89	6.17	19.27	11.0	0.76
DASF-15P	39.14	25.24	33.32	8.35	12.55	10.71	5.97	27.50	11.0	0.76
DASF-15S	39.14	24.66	33.32	7.90	12.55	10.89	6.17	27.50	11.0	0.76
DBSF-25P	53.03	38.96	47.04	8.35	12.55	10.82	5.97	41.27	11.0	0.99
DBSF-25S	53.03	38.33	47.04	7.90	12.55	10.89	6.17	41.27	11.0	0.76
DCSF-37P	69.32	55.42	63.50	8.35	12.55	10.82	5.97	57.70	11.0	0.99
DCSF-37S	69.32	54.48	63.50	7.90	12.55	10.89	6.17	57.70	11.0	0.76

TERMINATION TOOLING

Speedy-D connectors can be terminated by hand or pneumatic presses. Connectors are placed into locator block in a pre-assembled, pre-loaded condition which makes handling fast and simple. A pneumatically operated version is available to ease operator fatigue on higher volume production.

SPEEDY-D TOOLING



Hand Termination Press
Description: CHP-420
Part No.: 121086-0041
Locator Die: 121086-1620



Pneumatic Press
Description: CPP-460
Part No.: Consult Factory
Locator Die: 121086-1620

ED* SERIES

SHIELDED RIGHT ANGLE RECEPTACLES FOR P.C.B. MOUNTING

The ED* Series, Cannon's low cost shielded printed circuit board connector, offers proven design advantages:

- Metal shell and integral ground strap comply with EMI/RFI requirements.
- Short — .318 (8.08) — body length saves space.
- Eyelet mounting version eliminates extra hardware — speeds installation.



STANDARD DATA

MATERIALS AND FINISHES

	Material	Finish
Housing	Polyester, glass filled, UL 94V-0 rated	Black
Contacts	Phosphor bronze	Selective gold (.000015 min.) on mating end over nickel (.000050 min.); tin/lead on termination end (standard).
Shell		
Grounding	Steel	Tin-lead
Eyelet	Brass	Tin-lead

MECHANICAL FEATURES

Coupling — Friction and lock accessories
 Polarization — Keystone-shaped shells

PERFORMANCE SPECIFICATIONS

Dielectric Withstanding Voltage — 1000 VAC sea level
 Operating Temperature — - 65 °C to + 125 °C
 Current — 3 Amps max.

HOW TO ORDER

Contact Arrangement	Part Number			
	Standard .130 (3.30) Dia. Thru Holes for PCB Mounting		Optional Extended Eyelet for PCB Mounting	
	Flange Mount Holes with Threaded Inserts	Flange Mount Holes with Female Screwlocks	Flange Mount Holes with Threaded Inserts	Flange Mount Holes with Female Screwlocks
9	EDEL9SBA1	EDEM9SBA1	EDEL9SBA2	EDEM9SBA2
15	EDAL15SBA1	EDAM15SBA1	EDAL15SBA2	EDAM15SBA2
19	EDGL19SBA1	EDGM19SBA1	EDGL19SBA2	EDGM19SBA2
25	EDBL25SBA1	EDBM25SBA1	EDBL25SBA2	EDBM25

CONTACT ARRANGEMENTS (Face View Pin Insert)

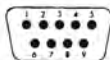

EDE-9

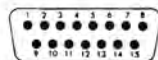

EDA-15

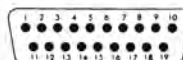

EDG-19



EDB-25

SHELL DIMENSIONS

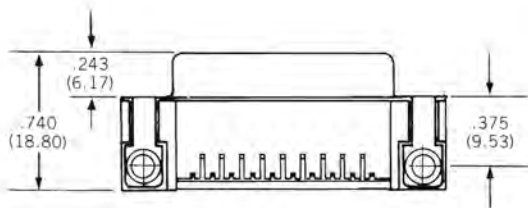
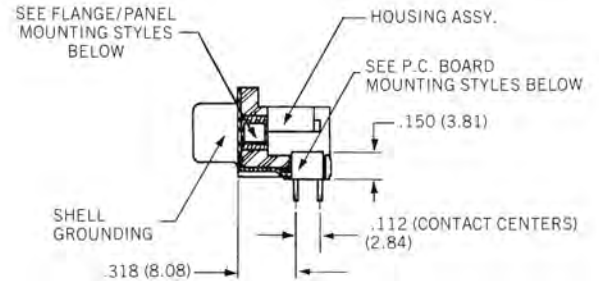
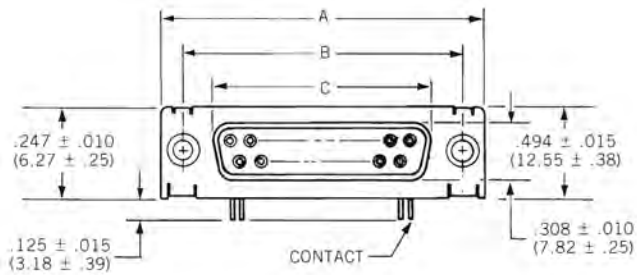

Shell Size	Basic Part Number	INCHES			MILLIMETERS		
		A ± .015	B ± .005	C ± .005	A ± 0.38	B ± 0.13	C ± 0.13
DE	EDE-9	1.213	.984	.643	30.81	24.99	16.33
DA	EDA-15	1.541	1.312	.971	39.14	33.32	24.66
DG	EDG-19	1.761	1.525	1.184	44.73	38.74	30.07
DB	EDB-25	2.088	1.852	1.511	53.04	47.04	38.38

FLANGE/PANEL MOUNTING STYLES

THREADED INSERTS

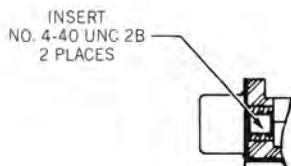

FEMALE SCREW LOCKS

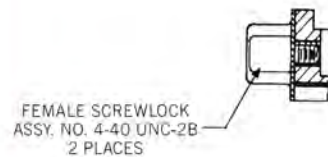

P.C. BOARD MOUNTING STYLES

STANDARD .130 (3.30) DIA. THRU HOLES

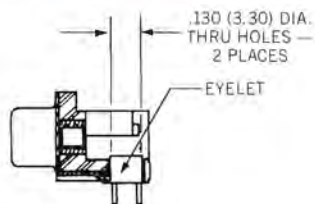

EYELET MOUNTING STYLE

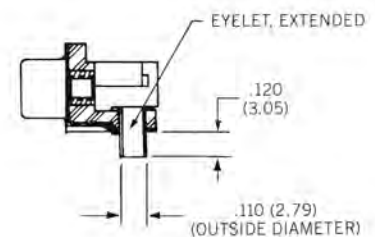

PC BOARD PATTERNS

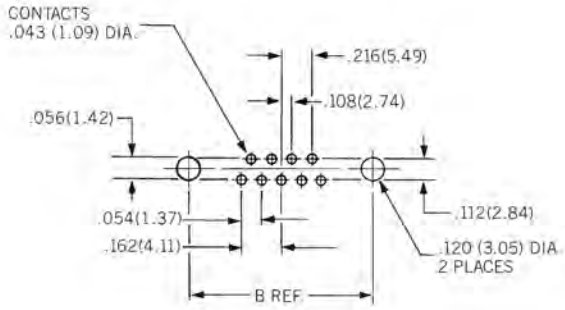

9 POSITION PCB HOLE PATTERN

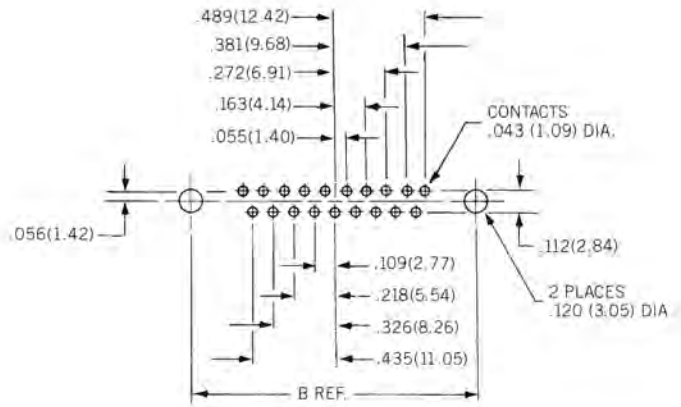

19 POSITION PCB HOLE PATTERN

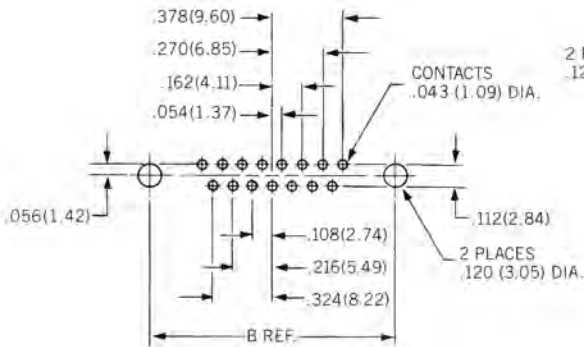

15 POSITION PCB HOLE PATTERN

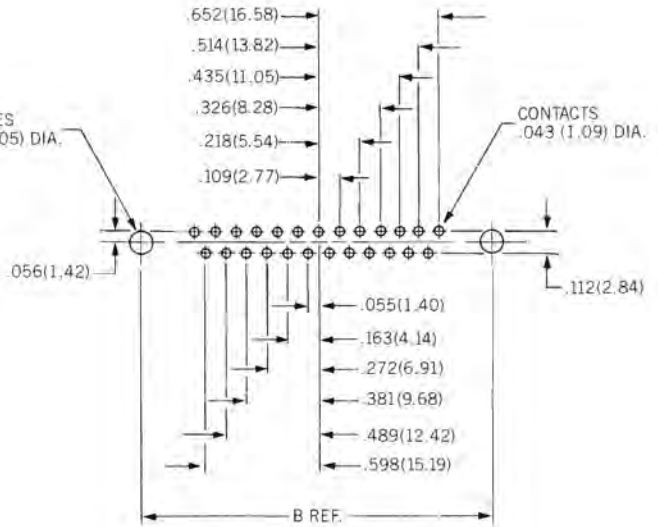

25 POSITION PCB HOLE PATTERN

Recommended board thickness is .093 (2.36) max.
 Recommended printed circuit board hole size is .041 (1.04)
 See page 64 for panel cutouts.

**PLASTIC 90° D*P
A UNIVERSAL LOW COST RIGHT-ANGLE
CONNECTOR FOR PRINTED CIRCUIT BOARDS.**

90° D*P right-angle printed circuit board connectors are ideal for telecommunications, computer, industrial control and other applications that require low cost and high performance. Made from a flame retardant, U.L. listed, glass filled thermoplastic, the D*P can be mounted directly over printed circuit patterns without causing short circuiting. The D*P can be used to replace any D Subminiature-type 90° printed circuit connector without redrilling the circuit boards or requiring extra hardware.

The D*P is fully intermateable with all D Subminiature connectors.

90° D*P connectors are available in pin and socket versions, with a choice of five contact arrangements accommodating stamped and formed non-removable contacts. Design them into your next product for high performance at a low price.



STANDARD DATA

MATERIALS AND FINISHES

	Materials	Finishes
Housing/Retainer	Glass-filled thermoplastic, UL 94V-0 rated, black	—
Contacts	Copper alloy, stamped	Engaging End: Gold over nickel electroplate Termination End: Tin/Lead electroplate

MECHANICAL FEATURES

- Coupling—Friction.
- Polarization—Keystone shape.
- Contact Type—Captivated.
- Contact Termination—Solder.

PERFORMANCE SPECIFICATIONS

- Current Rating—3 Amps
- Dielectric Withstanding Voltage—600 VAC sea level.
- Insulation Resistance—1000 megohms minimum.
- Temperature Range— -55°C to +125°C

HOW TO ORDER

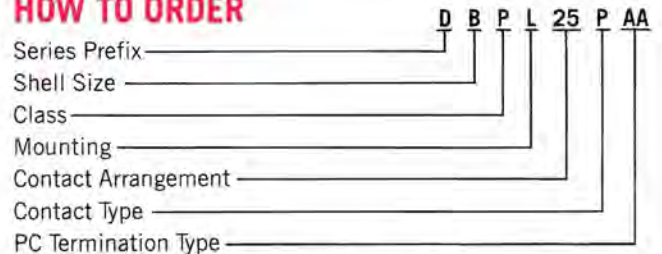

- SERIES**
D Subminiature
- SHELL SIZES**
E, A, B, C, D
- CLASS**
P — UL listed flame retardant thermoplastic
- MOUNTING**
L — 4-40 threaded inserts installed in mounting holes
M — 4-40 female screw locks installed in mounting holes
- (Mounting Con't)**
— dash (no designator), standard .120 (3.05) dia. mounting holes
- CONTACT ARRANGEMENTS**
9, 15, 25, 37, 50*
- CONTACT TYPE**
P — Pin
S — Socket
- PC TERMINATION TYPE**
AA — 90°, 4.78 (12.14) length
CA — 90°, .590 (14.99) length
- *DDP-50 Available in AA type only.

CONTACT ARRANGEMENTS

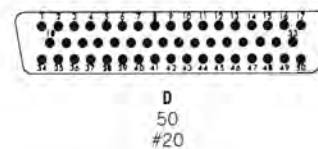
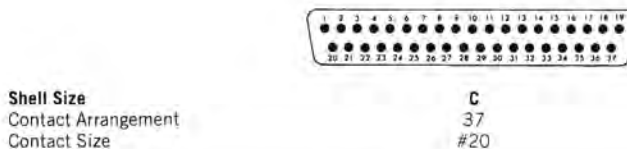
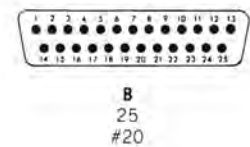
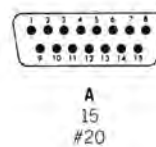

PIN CONNECTOR

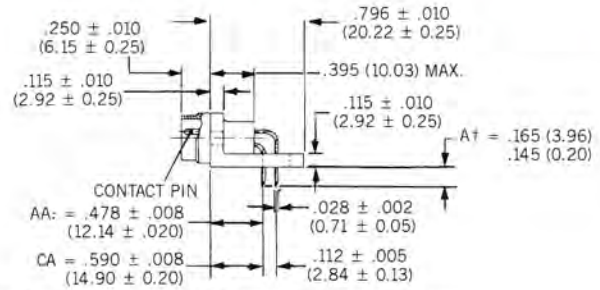
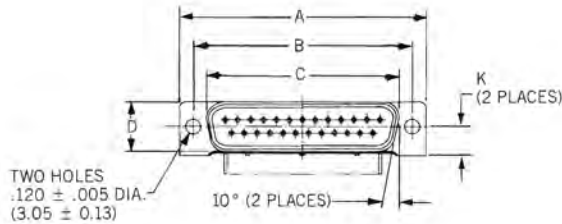

AA: For replacing Cannon 90° D Subminiature type connectors.
CA: For replacing other 90° PCB connectors.
† For other contact extensions, consult factory.

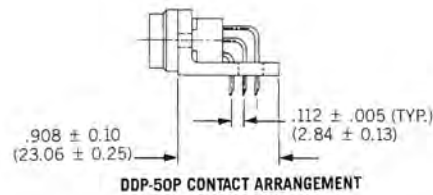
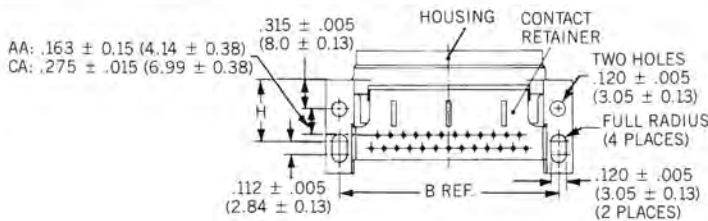

SOCKET CONNECTOR

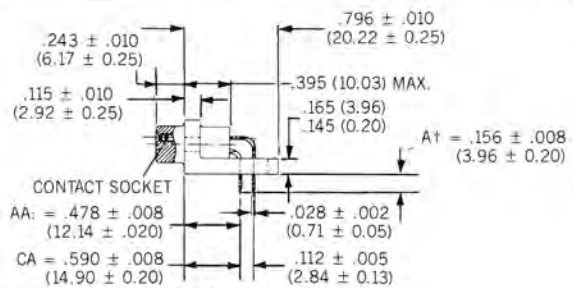
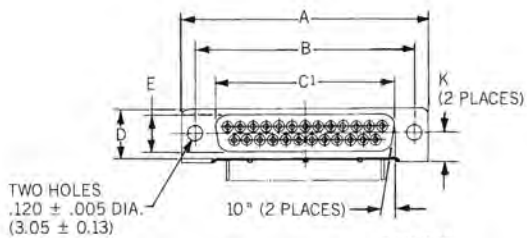

AA: For replacing Cannon 90° D Subminiature type connectors.
CA: For replacing other 90° PCB connectors.
† For other contact extensions, consult factory.

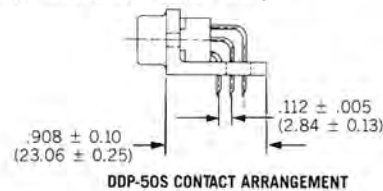
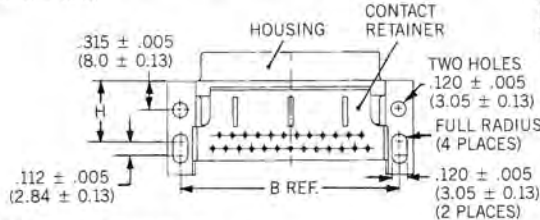

See page 63 for P.C. board hole patterns.

Part Number by Shell Size	Inches								Millimeters							
	A	B	C	C'	D	E	H	K	A	B	C	C'	D	E	H	K
DEP-9P*	± .015	± .005	± .010	± .005	± .015	± .005	± .005	± .010	± 0.38	± 0.13	± 0.25	± 0.13	± 0.38	± 0.13	± 0.13	± 0.25
DEP-9S*	1.213	.984	.752	—	.419	—	.523	.245	30.81	24.99	19.10	—	10.64	—	13.28	6.22
DAP-15P*	1.543	1.312	1.080	—	.419	.311	.523	.245	39.19	39.19	27.43	—	10.64	—	13.28	6.22
DAP-15S*	1.543	1.312	—	.971	.419	.311	.523	.245	39.19	39.19	—	24.66	10.64	7.90	13.28	6.22
DBP-25P*	2.085	1.852	1.620	—	.419	—	.523	.245	52.96	47.04	41.15	—	10.64	—	13.28	6.22
DBP-25S*	2.085	1.852	—	1.511	.419	.311	.523	.245	52.96	47.04	—	38.38	10.64	7.90	13.28	6.22
DCP-37P*	2.729	2.500	2.268	—	.419	—	.523	.245	69.32	63.50	57.61	—	10.64	—	13.28	6.22
DCP-37S*	2.729	2.500	—	2.159	.419	.311	.523	.245	69.32	63.50	—	54.84	10.64	7.90	13.28	6.22
DDP-50P*	2.635	2.406	2.168	—	.525	—	.558	.300	66.93	61.11	55.07	—	13.34	—	14.17	7.62
DDP-50S*	2.635	2.406	—	2.064	.525	.423	.558	.300	66.93	61.11	—	52.43	13.34	10.74	14.17	7.62

*Add PC Termination Type

D* PF SERIES

D*PF all plastic printed circuit board connectors are ideal for telecommunication, computer, and other applications requiring low cost, high performance connectors. They are interchangeable with all D Subminiature connectors and can replace any D Subminiature PC connector.

- Low profile
- Tin dipped PC tails
- UL94V-0 insulator material



STANDARD DATA

MATERIALS AND FINISHES

Shell/Insulator	Glass-reinforced thermoplastic, UL rated 94V-0
Contacts	Copper alloy, selective plated: gold on contact area with tinned terminations

MECHANICAL FEATURES

- Coupling—Friction
- Polarization—Keystone shape
- Contact type—Captive
- Contact terminations—Printed circuit tails and wrap post terminations
—Crimp contacts

ELECTRICAL DATA

- Current Rating—3A
- Dielectric withstanding voltage—600V
- Insulation resistance— $\geq 1000 \text{ M } \Omega$
- Temperature range— -25°C to $+85^{\circ}\text{C}$
- Contact resistance— $\leq 15 \text{ m } \Omega$

ORDERING INFORMATION

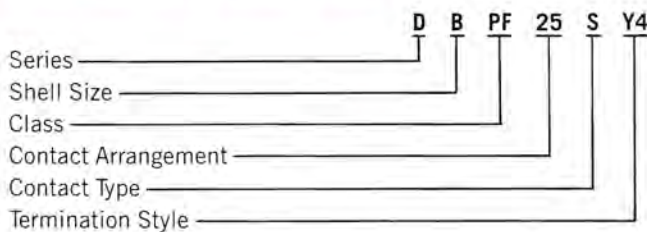

CLASS

PF — All plastic

CONTACT ARRANGEMENTS

9, 15, 25, 37, 50 contacts

CONTACT TYPE

- P — Pin
- S — Socket

TERMINATION STYLE

- K3 — 3 wrap termination .024 (0.60) square; .500 (12.70) ext.
- Y4 — Straight P.C. termination
- V6 — 90° P.C. termination
- Y44 — Straight P.C. termination with .440 (11.18) threaded inserts and board standoff
- Y47 — Straight P.C. termination with female screw-locks #4-40 UNC 2B
- Y48 — With 2 plastic spacers
- V62 — 90° P.C. termination with female screw-locks #4-40 UNC 2B
- CA — 90° 25s only .318 (8.08) foot print

SERIES

D — ITT Cannon designation

SHELL SIZE

- E — 9 contacts
- A — 15 contacts
- B — 25 contacts
- C — 37 contacts
- D — 50 contacts

CONTACT ARRANGEMENTS (Face View Pin Insert)

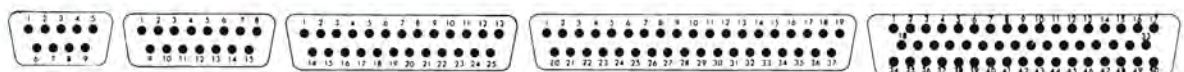

Shell Size	E	A	B	C	D
Contact Arrangement	9	15	25	37	50
Contact Size	#20	#20	#20	#20	#20

SHELL DIMENSIONS PLUG 9 TO 37

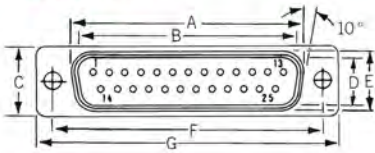

STRAIGHT VERSION

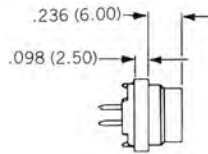

90° VERSION

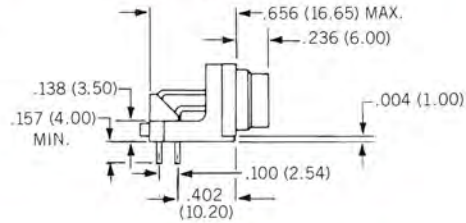

RECEPTACLE 9 TO 37

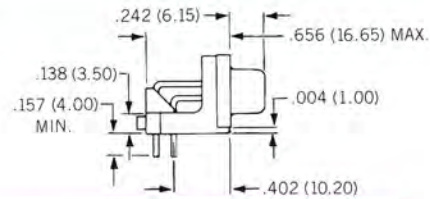
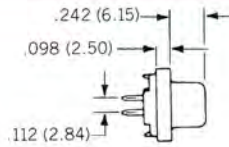
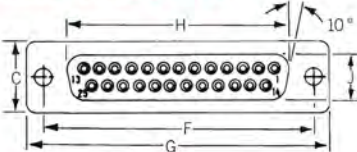

PLUG 50

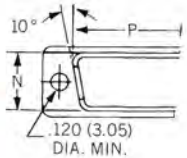
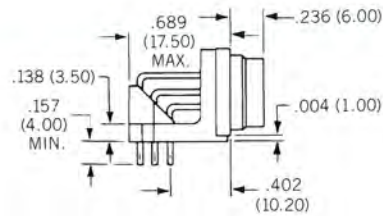
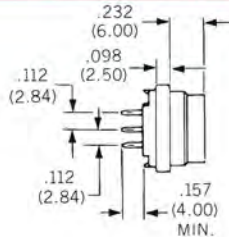
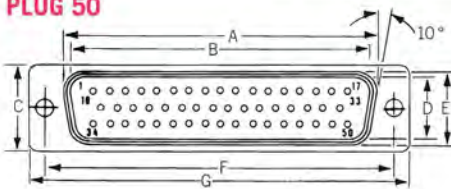

RECEPTACLE 50

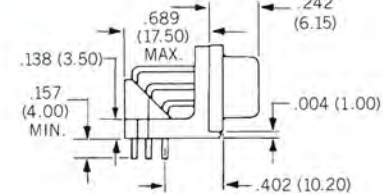
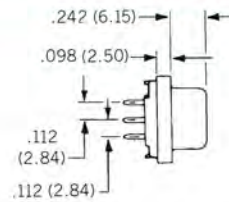
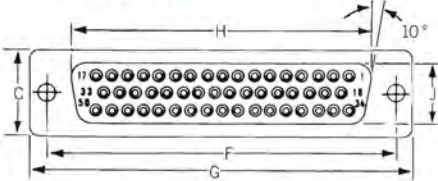

INCHES

N.B.: It is not recommended to mate p.c. connectors before they are soldered to the p.c. board.

Part Number by Shell Size	A	B	C	D	E	F	G	H	J	N	P
DEPF-9P*	.742	.663	.488	.327	.406	.984	1.206	—	—	.433	.765
DEPF-9S*	—	—	.488	—	—	.984	1.206	.656	.319	.433	.765
DAPF-15P*	1.071	.992	.488	.327	.406	1.312	1.530	—	—	.433	1.093
DAPF-15S*	—	—	.488	—	—	1.312	1.530	.984	.319	.433	1.093
DBPF-25P*	1.610	1.531	.488	.327	.406	1.852	2.078	—	—	.433	1.634
DBPF-25S*	—	—	.488	—	—	1.852	2.078	1.524	.319	.433	1.634
DCPF-37P*	2.258	2.179	.488	.327	.406	2.500	2.730	—	—	.433	2.282
DCPF-37S*	—	—	.488	—	—	2.500	2.730	2.171	.319	.433	2.282
DDPF-50P*	2.156	2.077	.600	.433	.512	2.406	2.630	—	—	.543	2.188
DDPF-50S*	—	—	.600	—	—	2.406	2.630	2.069	.425	.543	2.188

MILLIMETERS

Part Number by Shell Size	A	B	C	D	E	F	G	H	J	N	P
DEPF-9P*	18.85	16.85	12.40	8.30	10.30	25.00	30.64	—	—	11.00	19.44
DEPF-9S*	—	—	12.40	—	—	25.00	30.64	16.65	8.10	11.00	19.44
DAPF-15P*	27.20	25.20	12.40	8.30	10.30	33.32	38.86	—	—	11.00	27.77
DAPF-15S*	—	—	12.40	—	—	33.32	38.86	25.00	8.10	11.00	27.77
DBPF-25P*	40.90	38.90	12.40	8.30	10.30	47.04	52.78	—	—	11.00	41.51
DBPF-25S*	—	—	12.40	—	—	47.04	52.78	38.70	8.10	11.00	41.51
DCPF-37P*	57.35	55.35	12.40	8.30	10.30	63.50	69.34	—	—	11.00	57.97
DCPF-37S*	—	—	12.40	—	—	63.50	69.34	55.15	8.10	11.00	57.97
DDPF-50P*	54.75	52.75	15.25	11.00	13.00	61.11	66.80	—	—	13.80	55.58
DDPF-50S*	—	—	15.25	—	—	61.11	66.80	52.55	10.80	13.80	55.58

* Add Termination Style

TERMINATION TYPE

K3

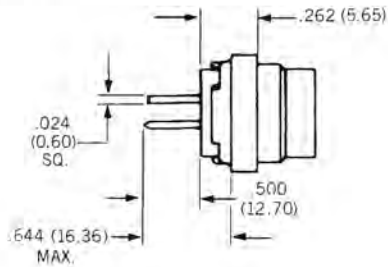

Y4

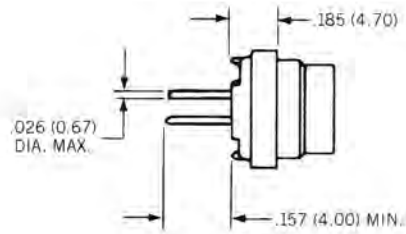

V6

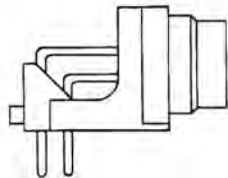

Y47

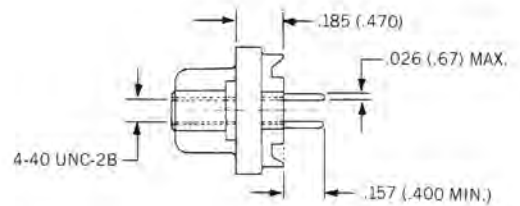

— WITH TWO FEMALE SCREWLOCKS 4-40 UNC-2B INSTALLED IN FLANGE

Y48

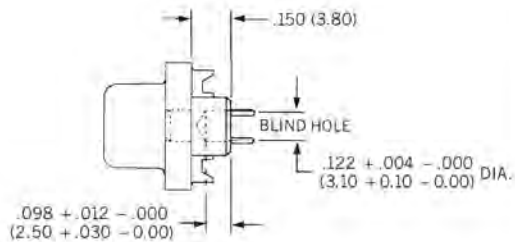

— WITH TWO PLASTIC SPACERS

V62

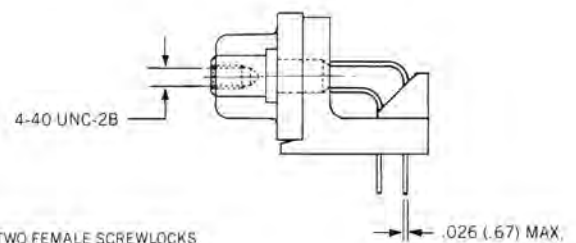

— WITH TWO FEMALE SCREWLOCKS 4-40 UNC-2B INSTALLED IN FLANGE

SHIELDED-D

Silence! Brought to you by ITT Cannon Shielded D Subminiature Series connectors. Designed to meet even the most stringent EMI/RFI requirements, including FCC Docket 20780 for all electronic equipment that generates signals from 10 kHz to 1000 MHz.

ITT Cannon offers a variety of D Subminiature connectors and accessories to meet virtually all shielding requirements:

- **Shielded/Shrouded Backshells** feature a brass shield, plastic shroud and latching mechanism. Ordering information is shown below.
- **Plated Plastic Backshells** offer 50° cable exit for reduced clearance requirements. Ordering information is shown on page 28.
- **Die Cast RFI Backshells** are rugged with aluminum straight and 90° cable exits, intended for applications where strength and durability are prime considerations. Ordering information is shown on page 28.



- **Filter D Subminiature Connectors and Adaptors** assure compliance with FCC Docket 20780 requirements without the need for expensive shielded cable. Transverse Monolith Filter Adaptors allow upgrade to EMI requirements without having to replace cables or connectors. For additional information on this filter product contact Phoenix Division Marketing Manager, ITT Cannon, 2801 Air Lane, Phoenix, Arizona 85034, telephone (602) 275-4792.

**HOW TO ORDER
Shielded/Shrouded Backshells**

**KIT 1
PLASTIC HOUSING
AND LATCH PLATE**

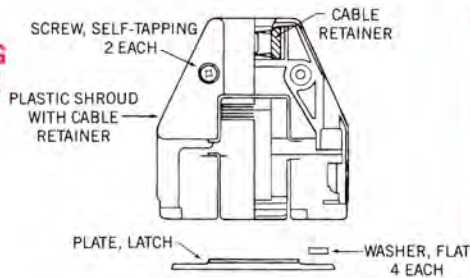

Comprised of the backshell, latch plate and 3 sets of cable retainers, including miscellaneous screws and washers.

HOW TO ORDER

Size	Kit Part Number
DA	DA 111409
DB	DB 111410
DC	DC 111411

**KIT 2
SHIELD EXTENSION
AND FERRULE**

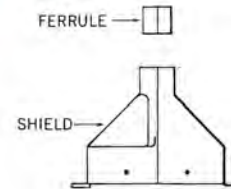

Comprised of the ferrule and shield.

HOW TO ORDER

Size	Kit Part Number
DA	DA 59104
DB	DB 59105
DC	DC 59106

**KIT 3
COMPLETE KIT**

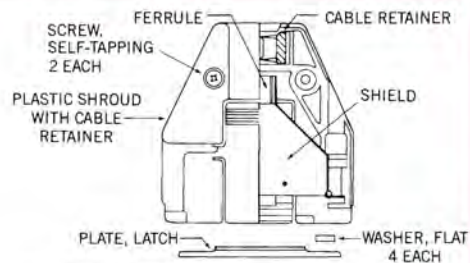

Comprised of backshell, latch plate, cable retainers, miscellaneous screws and washers, ferrule and shield.

HOW TO ORDER

Size	Kit Part Number
DA	DA 111401
DB	DB 111402
DC	DC 111403

KIT MATERIALS

Description	Material	Finish
Plastic Shroud	Thermoplastic Flame Retardant	Matte Light Gray
Cable Retainer	UL listed 94-V0 rated	
Shield Extension		
Ferrule	Brass	Tin-Lead
Ground Spring	CRES	Tin-Lead
Hardware (Screws/Washers)	Steel	Cadmium/Zinc

Plastic shroud and three (3) sets of cable retainers come attached to common plastic runner.

**SHELL DIMENSIONS
Shielded/Shrouded**

Following are the envelope dimensions for shell sizes DA, DB and DC. Also shown in detail A and as an optional accessory is the Captive Screw Kit (male). This kit is used with the Screwlock Kit (female). These kits are ordered separately. The Captive Screw Kit enables you to use shielded backshells with existing panel mounted connectors having female screwlocks.

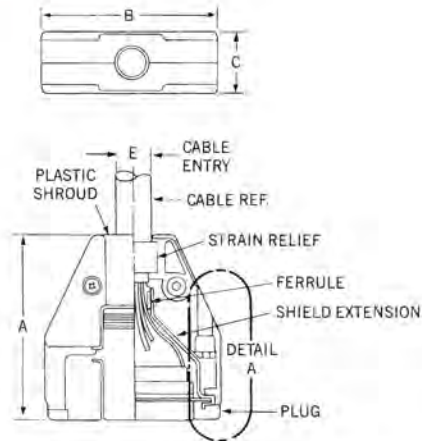

**OPTIONAL ACCESSORY
DETAIL A**

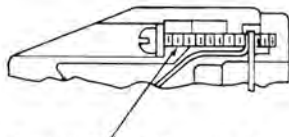

Captive Screw Kit (male) to be used with the Screw Lock Kit (female) for permanent secured fastening. Must be ordered separately. Part Number D111396. (Order 1 kit per connector.)

**FEMALE SCREW
LOCK**

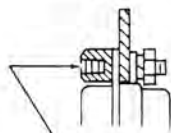

D20418-2
(ORDER 2 PER CONNECTOR)

Shell Size	DIM. A ± .020 (± 0.51)	DIM. B ± .020 (± 0.51)	DIM. C ± .020 (± 0.51)	DIM E MAX.
DA (15)	2.180 (55.37)	1.745 (17.78)	.700 (8.89)	.35 (8.89)
DB (25)	2.250 (57.15)	2.285 (17.78)	.700 (10.16)	.40 (10.16)
DC (37)	2.250 (57.15)	2.933 (74.50)	.700 (17.78)	.45 (11.43)

MOUNTING AND ASSEMBLY INFORMATION

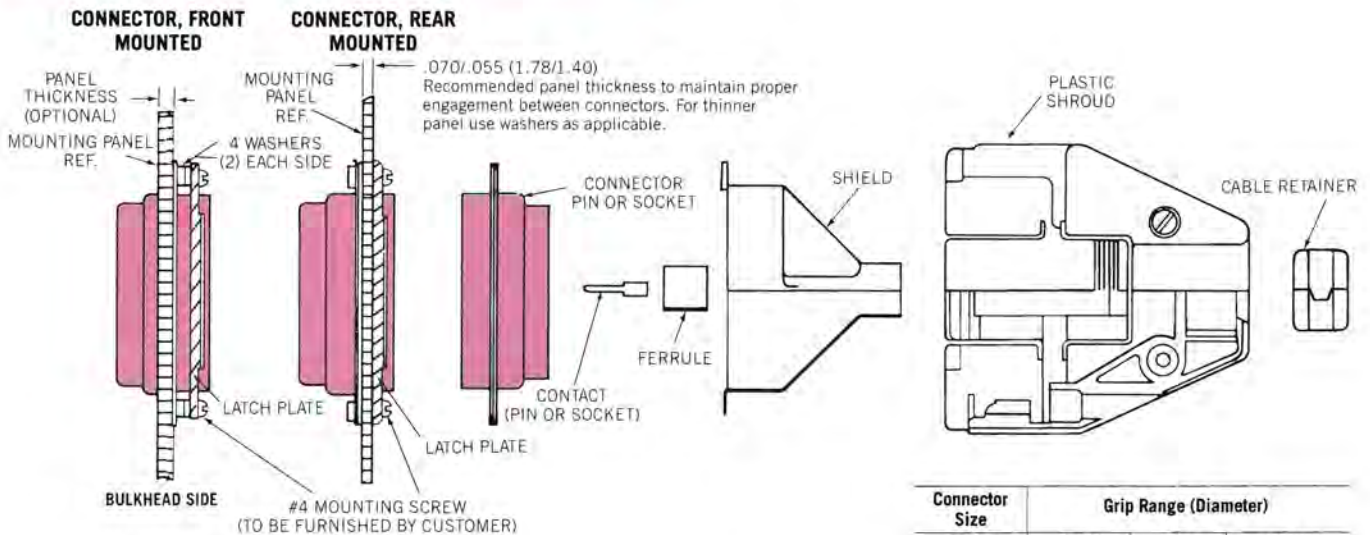

EXPLODED VIEW

Cable retainers are provided in three grip ranges for each connector size to accommodate the cable jacket diameters tabulated below. (A combination of cable retainers may be used to accommodate a variety of alternate cable sizes.)

Connector Size	Grip Range (Diameter)		
	DA (15)	25/29 (6.35/7.37)	29/32 (7.37/8.13)
DB (25)	30/34 (7.62/8.64)	34/37 (8.64/9.40)	37/40 (9.40/10.16)
DC (37)	35/39 (8.89/9.91)	39/42 (9.91/10.67)	42/45 (10.67/11.43)

For cable diameters not shown please consult the factory.

CRIMP TOOLS Shielded/Shrouded

FERRULE CRIMPING

Both manual and semiautomatic equipment is available to ease the application of crimping the ferrule to the shielded backshells. The manual CCT HX4 with 3 special cavity die sets will accommodate all ferrule sizes as well as reduce costs. As volumes increase and your thoughts turn to automation, our ABT-606-SD, a pneumatically operated semiautomatic crimper will give your high volume backshell ferrule crimping as quickly as an operator can feed. "When you think crimp, think Cannon".



ABT 606 SD



CCT HX4 w/die sets
Basic crimp tool: CCT HX4
Frame Part 995-0001-761

For Size DA use
Hex Die Set 995-0002-046
For Size DB use
Hex Die Set 995-0001-878
For Size DC use
Hex Die Set 995-0001-885

CABLE TERMINATION DATA BRAIDED SHIELD CABLE

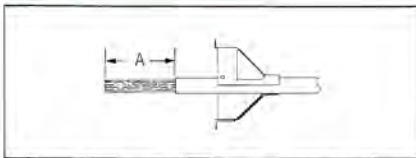

1. Slide shield onto cable and strip outer jacket to dim shown in table below.

Shell Size	A ± .05 (± 1.27)
DA	1.55 (39.37)
DB	1.55 (39.37)
DC	1.88 (47.75)

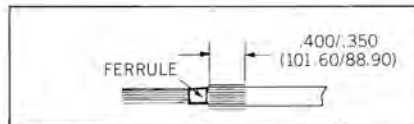

2. Comb braid back over outer jacket and trim to dim shown. Slide ferrule over exposed wires.

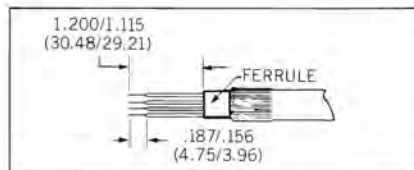

3. Strip wires and terminate contacts per specification.

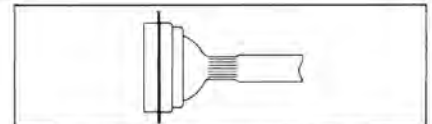

4. Insert contacts into connector comb braid forward over ferrule holding ferrule firmly against outer jacket.

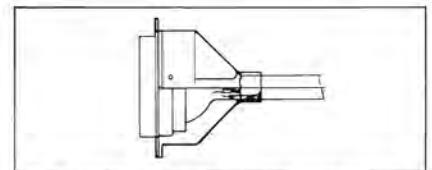

5. Slide shield over ferrule until shield flanges are flush with connector flanges. When applicable, drain wire is captured between ferrule and shield. Crimp shield to ferrule (see above for proper tool).

TYPICAL BOTH CABLE ASSEMBLIES

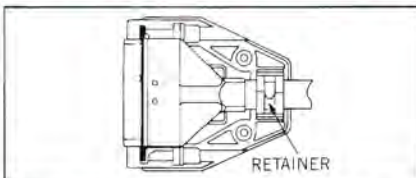

6. Place applicable cable retainers on cable then place cable retainer into shroud as shown.

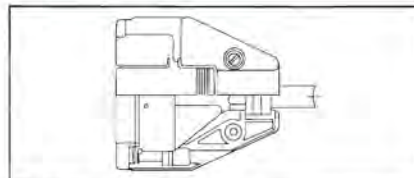

7. Place other half or shroud over assembly and screw together with furnished self-tapping screws.

FOIL SHIELD CABLE

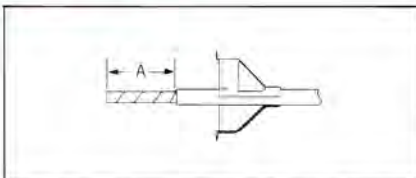

1. Slide shield onto cable and strip outer jacket to dim shown in table below.

Shell Size	A ± .05 (± 1.27)
DA	1.55 (39.37)
DB	1.55 (39.37)
DC	1.88 (47.75)

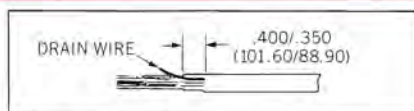

2. Trim foil shield to dim shown.

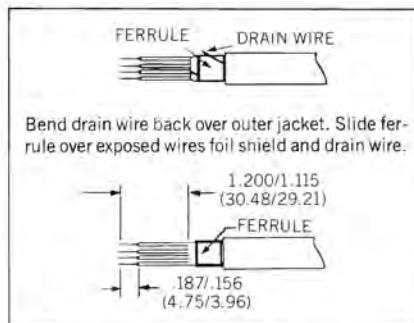

3. Strip wires and terminate contacts per specification.

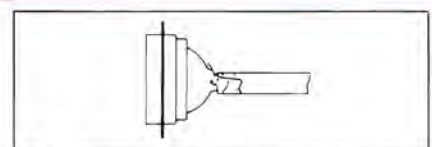

4. Insert contacts into connector bring drain wire forward over ferrule holding ferrule firmly against outer jacket. Trim drain wire.

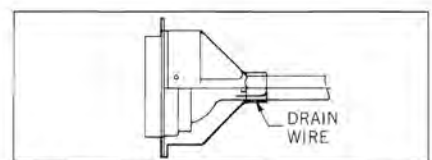

5. Slide shield over ferrule till shield flanges are flush with connector flanges. When applicable, drain wire is captured between ferrule and shield. Crimp shield to ferrule (see above for proper tool).

PLATED PLASTIC JUNCTION SHELL

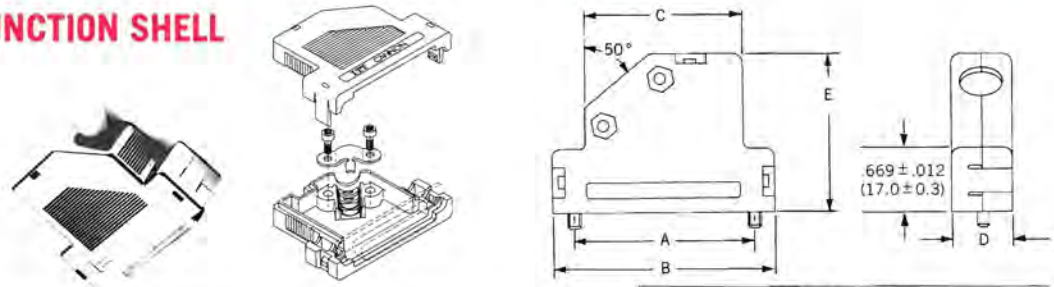

Part Number	Connector Size	A ± .006(0.15)	B ± .012(0.30)	C ± .012(0.30)	D ± .012(0.30)	E ± .012(0.30)	Cable Dimensions			
							Outer Jacket		Shield	
							Min.	Max.	Min.	Max.
DA121073-50	DA-15	1.311(33.30)	1.744(44.30)	1.075(27.30)	.630(16.00)	1.654(42.00)	256(6.50)	304(9.00)	.138(3.50)	295(7.50)
DB121073-51	DB-25	1.850(47.00)	2.283(58.00)	1.614(41.00)	.630(16.00)	1.654(42.00)	256(6.50)	433(11.00)	.138(3.50)	374(9.50)
DC121073-52	DC-37	2.500(63.50)	2.933(74.50)	2.264(57.50)	.630(16.00)	1.654(42.00)	256(6.50)	433(11.00)	.138(3.50)	374(9.50)
DD121073-53	DD-50	2.406(61.10)	2.839(72.10)	2.642(67.10)	.748(19.00)	1.654(42.00)	354(9.00)	512(13.00)	.236(6.00)	453(11.00)
DE121073-54	DE-9	.984(25.00)	1.417(36.00)	.866(22.00)	.630(16.00)	1.417(36.00)	138(3.50)	295(7.50)	.075(2.00)	236(6.00)

STANDARD DATA

Shell—ABS polymer
 Finish—Nickel plate over copper
 Temperature Range— -20°C to +80°C
 Cable Strip Length For Shielding—.250 (6.40) min.
 Attenuation—44 DB @ 1000 MHz

LOCKING HARDWARE

An optional screw lock is available for use with junction shells. This screw lock mates to standard D20418-2 female screw locks. Order 2 pieces per junction shell.

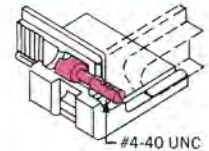

Part Number 250-8501-004

**RFI/EMI DIE CAST
JUNCTION SHELL FOR
SHIELDED CABLES**

Material—Aluminum alloy
 Plating—Clear conductive coating over cadmium

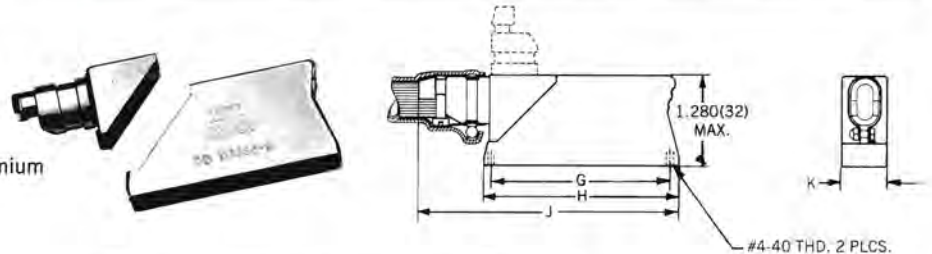

Part Number	G ± .005(0.13)	H ± .010(0.25)	J Max.	K Max.
DB 115386-72	1.850(47.04)	2.169(55.0)	2.992(76.00)	636(16.15)
DC 115386-82	2.500(63.50)	2.819(71.60)	3.637(92.40)	636(16.15)
DD 115386-92	2.406(61.10)	2.717(69.0)	3.543(90.00)	748(19.0)

NOTE: Cable, cable shielding, tie-rip, and heat shrinkable tubes have to be furnished by customer.

CONNECTOR ORDERING INFORMATION

CONNECTOR ORDERING INFORMATION

Most standard D Subminiature connectors can be ordered with grounding capabilities. Typical system configurations include (1) grounded pin connector/standard socket connector and (2) standard pin connector/grounded socket connector.

Multiple grounding indentations are an option available on virtually any D Subminiature pin connector. Ground springs are available on the D*U series only.

Modification Code	Description	Usage
F201	Grounding indents (cadmium plate)	All D Subminiature pin connectors (metal shells)
K87	Grounding indents (tin plate)	All D Subminiature pin connectors (metal shells)
A197	Tin plate	All metal shell D Subminiatures
F197	Ground spring	D*U socket connectors



MARK I D*M

Cannon's Mark I D*M Series is widely used on military and commercial systems ranging from satellites to telecommunication and computer equipment. The D*M connector features a one-piece insulator for improved temperature characteristics and increased moisture resistance. This series, qualified to MIL-C-24308, is available in five #20 contact arrangements plus a variety of combination arrangements to accommodate snap-in coaxial, high voltage, or high power contacts. #20 solder cup contacts are standard. Printed circuit terminals and wrap posts are also available. All #20 signal contacts are non-removable.

For non-magnetic and/or non-outgassing applications the D*M connector is available in versions with NMB and NMC ratings and gold-plated shells.



HOW TO ORDER

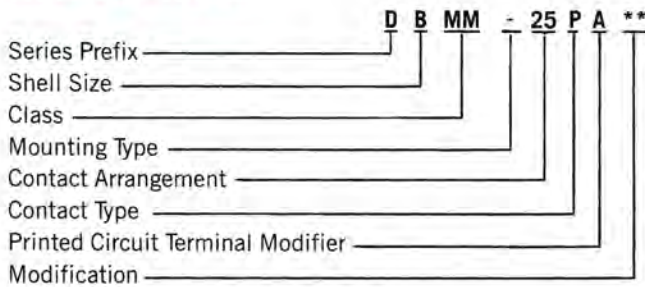

SERIES PREFIX

D

SHELL SIZE

A, B, C, D, E

CLASS

- M — One piece insulator
- MM— One piece insulator: materials, finishes, and inspection per MIL-C-24308 as applicable. See page 68-69 for QPL listing

MOUNTING TYPE

- No Designator: Standard .120 (3.05) diameter hole
- E — Two clinch nuts for rear panel mounting
- F — Float mounts for rear panel mounting
- K — .154 (3.91) diameter mounting holes
- R — Reverse float mounts for front panel mounting
- Y — Dual float mount for both front and rear panel mounting

CONTACT ARRANGEMENTS

See page 31

CONTACT TYPE

- P — Pin
- S — Socket

PRINTED CIRCUIT TERMINAL MODIFIER

See page 33

MODIFICATION

See page 66

NON-MAGNETIC APPLICATIONS

To order a connector with non-magnetic properties, add the appropriate suffix code to the part no. See page 30 for materials and finishes.

Suffix Code	Residual Magnetism	Shell Plating Finish	Typical Part No.
NM	2000 Gamma	Yellow chromate over cadmium	DBM-25P-NM
NMB	200 Gamma	Yellow chromate over cadmium	DBM-25P-NMB
NMB-K52	200 Gamma	Gold over copper	DBM-25P-NMB-K52
K52	—	Gold over copper	DBM-25P-K52



STANDARD DATA MATERIALS AND FINISHES

	STANDARD		M24308	
	Material	Finish	Material	Finish
Shell	Steel per ASTM A-620	Yellow chromate over cadmium QQ-P-416 Type II Class 2	Steel per ASTM A-620	Yellow chromate over cadmium QQ-P-416 Type II Class 2
Insulator	Diallyl phthalate glass-filled per MIL-M-14, type SDG-F, color green	—	Diallyl phthalate glass-filled per MIL-M-14, type SDG-F, color green	—
Contact	Copper alloy	Gold over nickel	Copper alloy	Gold 50 microinches minimum thickness per MIL-G-45204 Type II Grade C Class 1 over copper per MIL-C-14550
Float Mount Hardware	Stainless steel	Passivate per QQ-P-35	Stainless steel	Passivate per QQ-P-35

	NON-MAGNETIC	
	Material	Finish
Shell	Brass per QQ-B 613	NM: Yellow chromate over cadmium per QQ-P-35 NMB: Yellow chromate over cadmium per QQ-P-35 K52: Gold 50 microinches minimum thickness per MIL-G-45204 Type II Grade C Class 1 over copper per MIL-C-14550
Insulator	NM: Same as standard NMB: Diallyl phthalate per MIL-M-14, type SDG-F, color white unmilled, unpigmented K52: Same as standard	—
Contact	Copper Alloy	NM: Gold 50 microinches minimum thickness per MIL-G-45204 Type II Grade C Class 1 over copper per MIL-C-14550 NMB: Gold 50 microinches minimum thickness per MIL-G-45204 Type II Grade C Class 1 over copper per MIL-C-14550 K52: Gold 50 microinches minimum thickness per MIL-G-45204 Type II Grade C Class 1 over copper per MIL-C-14550
Float Mount Hardware	NM: Stainless steel NMB: Brass K52: Brass	NM: Passivate per QQ-P-35 NMB: Yellow chromate over cadmium per QQ-P-416 K52: Gold 50 microinches minimum thickness per MIL-G-45204 Type II Grade C Class 1 over copper per MIL-C-14550

PERFORMANCE SPECIFICATIONS

	STANDARD ARRANGEMENTS	HIGH POWER CONTACTS		HIGH VOLTAGE CONTACTS	COAXIAL CONTACTS
		Contact Size	Wire Size		
Wire Accommodation (AWG)	#20 Max.	0808 0812 0816	8 12 16	#20 Max.	See page 35 for ordering information
Current Rating	#20; 5 Amp	0808 0812 0816	40 Amp 20 Amp 10 Amp	5 Amp	5 Amp
Temperature Rating	-65°C to +150°C	-65°C to +150°C		-55°C to +125°C	-65°C to +150°C
Contact Resistance After Salt Spray, Millivolt Max.	55 @ 7.5 Amp test current	Contact Size	Test Amps	MV Drop	55 @ 7.5 Amp test current
		0808 0812 0816	40 20 10	40 20 15	

DIELECTRIC WITHSTANDING VOLTAGE

		Altitude (feet/m)							
		Sea Level		20,000/6096		50,000/15240		70,000/1336	
		90°	Straight	90°	Straight	90°	Straight	90°	Straight
Type of Contact	Average Flashover	1200	1500	900	1000	600	700	400	500
	Test	800	1000	600	650	400	475	275	325
High Power Contact and/or Coaxial Shell to Plug Shell	Average Flashover	1500	1500	1000	1000	500	500	500	500
	Test	1000	1000	650	650	325	325	325	325
Coaxial Shell to Nearest Standard Solder Pot Contact	Average Flashover	●	1500	●	1500	●	900	●	650
	Test	●	1000	●	1000	●	600	●	425
HV Contact to Nearest Contact or to Shell	Average Flashover	3800	3800	2300	2300	900	900	650	650
	Test	2800	2800	1700	1700	675	675	475	475
#20 Signal	Average Flashover	1700		1000		650		500	
	Test	1250		750		475		375	

All voltage figures are rms AC 60 rms cps, measured at approximately +25°C, 50% rh.
For additional performance specifications refer to MIL-C-24308 Test Extracts on page 67.

CONTACT ARRANGEMENTS (Face View Pin Insert)

BASIC ARRANGEMENTS

Shell Size	E	A	B	C	D
Contact Arrangement	9	15	25	37	50
Contact Size	#20	#20	#20	#20	#20

COMBINATION ARRANGEMENTS

(Will accommodate Removable Coax, Power and/or High Voltage Contacts, see pages 35-36 for ordering information)

Note: Color Code — Pin Connector: Red, Socket Connector: Blue

Shell Size	E	A	A	A	B	B
Contact Arrangement	5W1	3W3	7W2	11W1	5W5	9W4
No. of Contacts	4	0	5	10	0	5
Contact Size	#20	—	#20	#20	—	#20
Coax or HV Cavities	1	3	2	1	5	4

Shell Size	B	B	B	C
Contact Arrangement	13W3	17W2	21W1	8W8
No. of Contacts	10	15	20	0
Contact Size	#20	#20	#20	—
Coax or HV Cavities	3	2	1	8

Shell Size	C	C	C	C
Contact Arrangement	13W6	17W5	21WA4	25W3
No. of Contacts	7	12	17	22
Contact Size	#20	#20	#20	#20
Coax or HV Cavities	6	5	4	3

Shell Size	D	D	D
Contact Arrangement	24W7	36W4	43W2
No. of Contacts	17	32	41
Contact Size	#20	#20	#20
Coax or HV Cavities	7	4	2

STANDARD SHELL

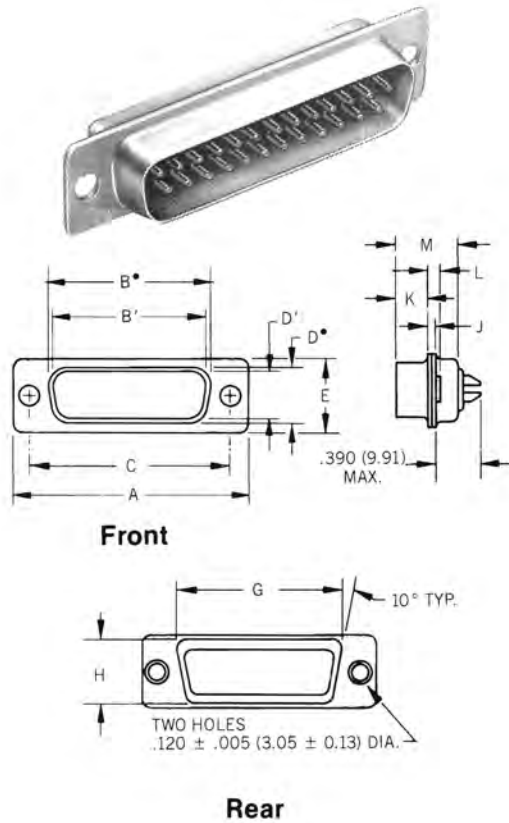

SHELL WITH FLOAT MOUNTS

For shell with float mounts, add letter F after letter M, e.g., DEMF9P

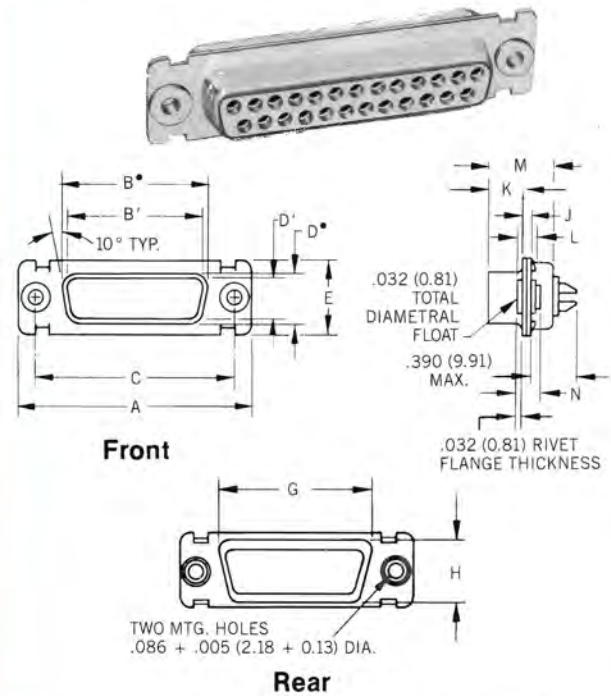

It is recommended that only one assembly, either pin or socket, be float mounted. For front panel mounting use reverse float mount; see page 65.

INCHES

Part Number by Shell Size	A ±.015	B ±.010	B' ±.010	C ±.005	D ±.010	D' ±.010	E ±.015	G ±.010	H ±.010	J ±.010	K ±.010	L ±.010	M ±.015	N ±.010
DEM-9P	1.213	—	.666	.984	—	.329	.494	.759	.422	.030	.236	.045	.422	.120
DEM-9S	1.213	.640	—	.984	.308	—	.494	.759	.422	.030	.243	.045	.429	.120
DAM-15P	1.541	—	.994	1.312	—	.329	.494	1.083	.422	.030	.236	.045	.422	.120
DAM-15S	1.541	.968	—	1.312	.308	—	.494	1.083	.422	.030	.243	.045	.429	.120
DBM-25P	2.088	—	1.534	1.852	—	.329	.494	1.625	.422	.039	.231	.060	.426	.129
DBM-25S	2.088	1.508	—	1.852	.308	—	.494	1.625	.422	.030	.243	.045	.429	.120
DCM-37P	2.729	—	2.182	2.500	—	.329	.494	2.272	.422	.039	.231	.060	.426	.129
DCM-37S	2.729	2.156	—	2.500	.308	—	.494	2.272	.422	.030	.243	.045	.429	.120
DDM-50P	2.635	—	2.079	2.406	—	.436	.605	2.178	.534	.039	.231	.060	.426	.129
DDM-50S	2.635	2.062	—	2.406	.420	—	.605	2.178	.534	.030	.243	.045	.429	.120

MILLIMETERS

Part Number by Shell Size	A ±0.38	B ±0.25	B' ±0.25	C ±0.12	D ±0.25	D' ±0.25	E ±0.38	G ±0.25	H ±0.25	J ±0.25	K ±0.25	L ±0.25	M ±0.38	N ±0.25
DEM-9P	30.81	—	16.91	24.99	—	8.36	12.55	19.28	10.72	0.76	5.99	1.14	10.72	3.05
DEM-9S	30.81	16.25	—	24.99	7.82	—	12.55	19.28	10.72	0.76	6.17	1.14	10.90	3.05
DAM-15P	39.14	—	25.24	33.32	—	8.36	12.55	27.51	10.72	0.76	5.99	1.14	10.72	3.05
DAM-15S	39.14	24.58	—	33.32	7.82	—	12.55	27.51	10.72	0.76	6.17	1.14	10.90	3.05
DBM-25P	53.03	—	38.96	47.04	—	8.36	12.55	41.27	10.72	0.99	5.87	1.52	10.82	3.28
DBM-25S	53.03	38.30	—	47.04	7.82	—	12.55	41.27	10.72	0.76	6.17	1.14	10.90	3.05
DCM-37P	69.31	—	55.42	63.50	—	8.36	12.55	57.71	10.72	0.99	5.87	1.52	10.82	3.28
DCM-37S	69.31	54.76	—	63.50	7.82	—	12.55	57.71	10.72	0.76	6.17	1.14	10.90	3.05
DDM-50P	66.92	—	52.81	61.11	—	11.07	15.37	55.32	13.56	0.99	5.87	1.52	10.82	3.28
DDM-50S	66.92	52.37	—	61.11	10.67	—	15.37	55.32	13.56	0.76	6.17	1.14	10.90	3.05

• Dimensions B, D, G, and H are measured as outside dimensions at the bottom of the draw.
NOTE: B• and D• are the O.D. dims. for socket side, B' and D' are the I.D. dims. for pin side.

PRINTED CIRCUIT APPLICATIONS

Select the appropriate code from the table below. Typical part no. DBM-25PA. See "How To Order" page 29 for additional instructions.

Code	Straight	Right Angle		X ± .027(0.69)	Y
		With Bracket	W/Out Bracket		
A		●		.127(3.22)	.040(1.02)
B	●			.127(3.22)	.040(1.02)
C			●	.127(3.22)	.040(1.02)
D		●		.127(3.22)	.030(0.76)
E	●			.127(3.22)	.030(0.76)
F			●	.127(3.22)	.030(0.76)
G		●		.158(4.01)	.040(1.02)
H	●			.158(4.01)	.040(1.02)
K			●	.158(4.01)	.040(1.02)
L		●		.158(4.01)	.030(0.76)
M	●			.158(4.01)	.030(0.76)
P			●	.158(4.01)	.030(0.76)
R			●	.183(4.65)	.030(0.76)
S		●		.183(4.65)	.030(0.76)
W		●		.183(4.65)	.040(1.02)
X	●			.183(4.65)	.040(1.02)
Z	●			.183(4.65)	.030(0.76)

RIGHT ANGLE 90° TERMINAL

Connectors are furnished with or without plastic bracket.

Connectors with brackets cannot be ordered with float mounts or clinch nuts.

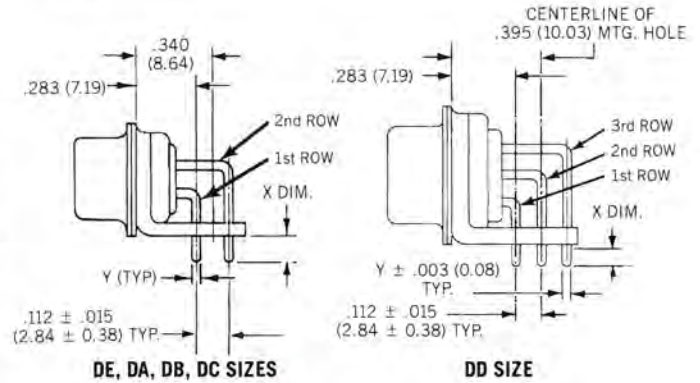

STRAIGHT TERMINAL

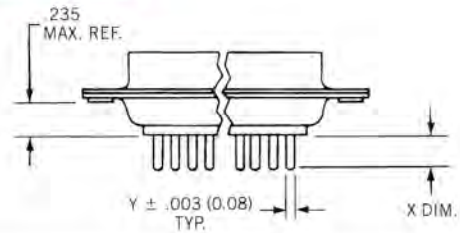

WIRE WRAPPING APPLICATIONS

Modification Code	Number of Wraps	W	H
F179	2	.375 (9.52)	.625 (15.88)
F179A	3	.500 (12.7)	.750 (19.05)

Typical Part Number: DMB-25P-F179

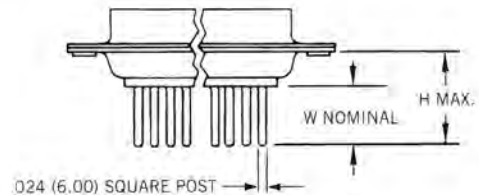

**MARK I D*M
COAXIAL, HIGH POWER, AND
HIGH VOLTAGE CONTACTS**

Mark I coax, high power, and high voltage contacts are available for use with Mark I combination arrangements. Purchased separately, they snap in and are front-release, rear-removable.

COAXIAL CONTACTS accommodate a variety of RG cables and are available in crimp braid, solder braid, and PC versions.

HIGH POWER CONTACTS are available in three sizes to accommodate #8 AWG through #16 AWG with maximum current rated at 40 amps.

HIGH VOLTAGE CONTACTS increase average flashover voltage to 3800 VAC sea level. A nylon dielectric shrouds a #20 center contact.

Connector ordering information is shown on page 35.



HIGH POWER



HIGH VOLTAGE



COAX

**STANDARD DATA
MATERIALS AND FINISHES**

Contact Type	Material	Standard Finish	Military Finish
MARK I COAXIALS			
Coaxial Plugs			
Outer Shell	Brass	Gold over nickel	A156*
Retainer Ring	Beryllium copper	Nickel	Nickel
Insulator	Teflon	None	None
Outer Sleeve	Brass	Gold over nickel	A156*
Socket Center Contact	Copper alloy	Gold over nickel	A156*
Coaxial Receptacles			
Outer Shell	Beryllium copper	Gold over nickel	A156*
Retainer Ring	Beryllium copper	Nickel	Nickel
Insulator	Teflon	None	None
Outer Sleeve	Brass	Gold over nickel	None
Pin Center Contact	Brass	Gold over nickel	A156*

Contact Type	Material	Standard Finish	Military Finish
HIGH POWER CONTACTS			
Plug	Brass	Gold over nickel	A156*
Receptacle	Beryllium copper	Gold over nickel	A156*
Retainer Ring	Beryllium copper	Nickel	None
HIGH VOLTAGE CONTACTS			
Pin Contact	Brass	Gold over nickel	A156*
Socket Contact	Copper alloy	Gold over nickel	A156*
Insulator	Nylon plug red receptacle blue	None	None
Retainer Ring	Beryllium copper	Nickel	Nickel

* A156 finish—Gold 50 microinches min. thickness per MIL-G-45204 Type II Grade C Class I over copper per MIL-C-14550.

For performance specifications see page 30.

**MARK I
COAXIAL CONTACTS
STRAIGHT CRIMP BRAID**

Color Code: Receptacle - Blue; Plug - Red

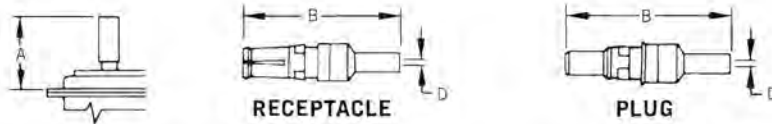

	Part Number		A Max.	B	D ± .005 (± 0.13)	RG Cable No.	
	Standard Finish	Military Finish*				Old	New
Plug	DM53740	DM53740-17	.739(18.8)	.945/.915(24.00/23.24)	.040(1.02)	196/U	178B/U
Plug	DM53740-1	DM53740-15	.739(18.8)	.945/.915(24.00/23.24)	.067(1.70)	187/U 188/U	179B/U 316B/U
Plug	DM53740-3	DM53740-16	.847(21.5)	1.052/1.022(26.72/25.96)	.110(2.79)	195/U	180B/U
Plug	DM53740-5	DM53740-18	.847(21.5)	1.052/1.022(26.72/25.96)	.125(3.18)	58/U	58B/U
Receptacle	DM53742	DM53742-18	.739(18.8)	.965/.917(24.51/23.29)	.040(1.02)	196/U	178B/U
Receptacle	DM53742-1	DM53742-16	.739(18.8)	.965/.917(25.51/23.29)	.067(1.70)	187/U 188/U	179B/U 316B/U
Receptacle	DM53742-3	DM53742-17	.847(21.5)	1.079/1.033(27.41/26.24)	.110(2.79)	195/U	180B/U
Receptacle	DM53742-5	DM53742-19	.847(21.5)	1.079/1.033(27.41/26.24)	.125(3.18)	58/U	58B/U

STRAIGHT SOLDER BRAID

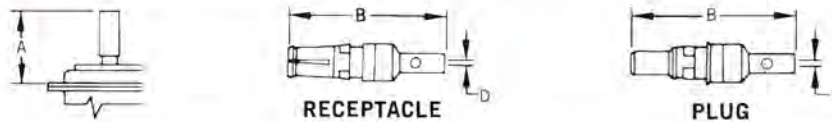

	Part Number		A Max.	B	D ± .005 (± 0.13)	RG Cable No.	
	Standard Finish	Military Finish*				Old	New
Plug	DM53740-5008	DM53740-5105	.739(18.8)	.945/.915(24.00/23.24)	.040(1.02)	196/U	178B/U
Plug	DM53740-5001	DM53740-5099	.739(18.8)	.945/.915(24.00/23.24)	.067(1.70)	187/U 188/U	179B/U 316B/U
Plug	DM53740-5002	DM53740-5104	.847(21.5)	1.052/1.022(26.72/25.96)	.110(2.79)	195/U	180B/U
Plug	DM53740-5005	DM53740-5101	.847(21.5)	1.052/1.022(26.72/25.96)	.125(3.18)	58/U	58B/U
Receptacle	DM53742-5006	DM53742-5092	.739(18.8)	.965/.917(24.51/23.29)	.040(1.02)	196/U	178B/U
Receptacle	DM53742-5001	DM53742-5089	.739(18.8)	.965/.917(25.51/23.29)	.067(1.70)	187/U 188/U	179B/U 316B/U
Receptacle	DM53742-5002	DM53742-5091	.847(21.5)	1.079/1.033(27.41/26.24)	.110(2.79)	195/U	180B/U
Receptacle	DM53742-5004	DM53742-5086	.847(21.5)	1.079/1.033(27.41/26.24)	.125(3.18)	58/U	58B/U
Plug (Short Type)	DM53740-5000	DM53740-5100	.670(17.0)	.876/.846(22.25/21.49)	.040(1.02)	196/U	178B/U
Receptacle (Short Type)	DM53742-5000	DM53742-5085	.670(17.0)	.898/.850(22.81/21.59)	.040(1.02)	196/U	178B/U

RIGHT ANGLE SOLDER BRAID

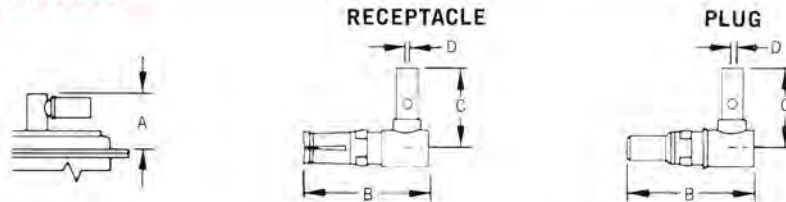

	Part Number		A Max.	B	C	D ± .005 (± 0.13)	RG Cable No.	
	Standard Finish	Military Finish*					Old	New
Plug	DM53741-5000	DM53741-5059	.530(13.46)	.745/.725(18.92/18.41)	.492(12.50)	.040(1.02)	196/U	178B/U
Plug	DM53741-5001	DM53741-5062	.530(13.46)	.745/.725(18.92/18.41)	.492(12.50)	.067(1.70)	187/U 188/U	179B/U 316B/U
Plug	DM53741-5003	DM53741-5063	.530(13.46)	.745/.725(18.92/18.41)	.601(15.27)	.110(2.79)	195/U	180B/U
Plug	DM53741-5004	DM53741-5060	.530(13.46)	.745/.725(18.92/18.41)	.601(15.27)	.125(3.18)	58/U	58B/U
Receptacle	DM53743-5000	DM53743-5073	.530(13.46)	.765/.729(19.43/18.52)	.492(12.50)	.040(1.02)	196/U	178B/U
Receptacle	DM53743-5001	DM53743-5076	.530(13.46)	.765/.729(19.43/18.52)	.492(12.50)	.067(1.70)	187/U 188/U	179B/U 316B/U
Receptacle	DM53743-5003	DM53743-5077	.530(13.46)	.765/.729(19.43/18.52)	.601(15.27)	.110(2.79)	195/U	180B/U
Receptacle	DM53743-5004	DM53743-5074	.530(13.46)	.765/.729(19.43/18.52)	.601(15.27)	.125(3.18)	58/U	58B/U

* MIL-C-24308 Finish: 0.00005(0.00127) minimum gold plate over copper plate (ITT Cannon code A 156).

MARK I COAXIAL CONTACTS (Continued) RIGHT ANGLE CRIMP BRAID

Color Code: Receptacle - Blue; Plug - Red

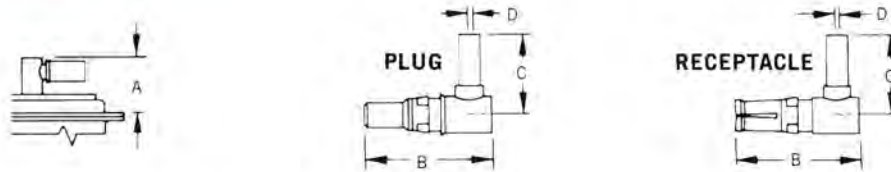

	Part Number	Military Finish*	A	B	C	D	RG Cable No.
	Standard Finish		Max.	Ref.		± .005(± 0.13)	Old New
Plug	DM53741	DM53741-12	.535(13.60)	.745/.725(18.92/18.41)	.492(12.50)	.040(1.02)	196/U 178B/U
Plug	DM53741-1	DM53741-11	.535(13.60)	.745/.725(18.92/18.41)	.492(12.50)	.067(1.70)	187/U 179B/U 188/U 316B/U
Plug	DM53741-3	DM53741-10	.535(13.60)	.745/.725(18.92/18.41)	.593(13.69)	.110(2.79)	195/U 180B/U
Plug	DM53741-4	DM53741-13	.535(13.60)	.745/.725(18.92/18.41)	.593(13.69)	.125(3.18)	58/U 58B/U
Receptacle	DM53743-2	DM53743-18	.535(13.60)	.765/.729(19.43/18.52)	.492(12.50)	.040(1.02)	196/U 178B/U
Receptacle	DM53743-3	DM53743-16	.535(13.60)	.765/.729(19.43/18.52)	.492(12.50)	.067(1.70)	187/U 179B/U 188/U 316B/U
Receptacle	DM53743-5	DM53743-17	.535(13.60)	.765/.729(19.43/18.52)	.593(13.69)	.110(2.79)	195/U 180B/U
Receptacle	DM53743-6	DM53743-19	.535(13.60)	.765/.729(19.43/18.52)	.593(13.69)	.125(3.18)	58/U 58B/U

STRAIGHT PRINTED CIRCUIT

PLUG

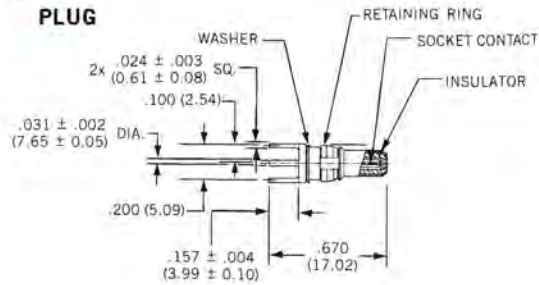

RECEPTACLE

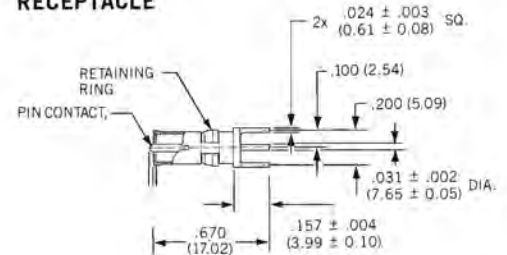

	Part Number	Military Finish*
	Standard Finish	
Plug	DM121073-200	DM121073-210
Receptacle	DM121073-201	DM121073-211

RIGHT ANGLE

PLUG

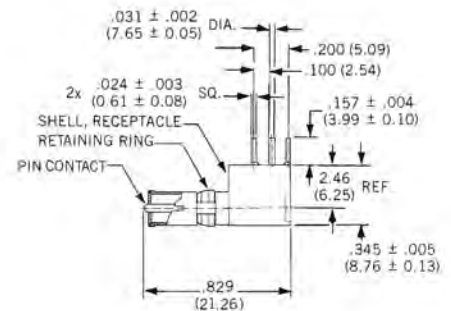
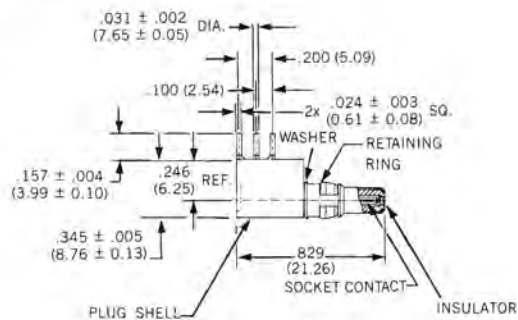

	Part Number	Military Finish*
	Standard Finish	
Plug	DM121073-202	DM121073-212
Receptacle	DM121073-203	DM121073-213

**MARK I
HIGH POWER CONTACTS
SOLDER TYPE**

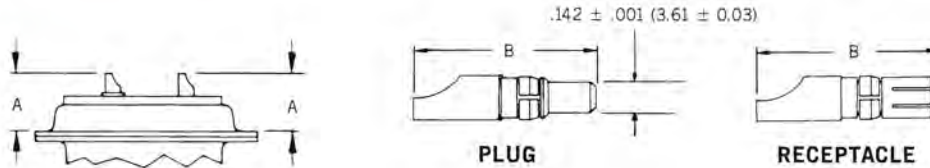

	Part Number		A Max.	B Ref.	Current Rating (Amps)	Wire Size
	Standard Finish	Military Finish*				
Plug	DM53745-1	DM53745-28	.666 (16.92)	.866 (22.00)	40	#8
Plug	DM53745-7	DM53745-27	.666 (16.92)	.866 (22.00)	20	#12
Plug	DM53745-8	DM53745-25	.666 (16.92)	.866 (22.00)	10	#16
Receptacle	DM53744-1	DM53744-21	.666 (16.92)	.856 (21.74)	40	#8
Receptacle	DM53744-6	DM53744-25	.666 (16.92)	.856 (21.74)	20	#12
Receptacle	DM53744-7	DM53744-24	.666 (16.92)	.856 (21.74)	10	#16

**MARK I
HIGH VOLTAGE CONTACTS
STRAIGHT**

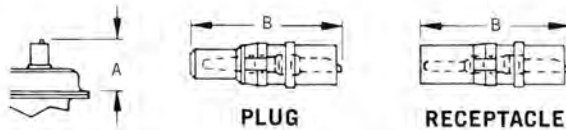

	Part Number		A Max.	B Ref.	Wire Size
	Std. Finish	Mil. Finish*			
Plug	DM51157	DM51157-8	.539 (13.69)	.734 (18.64)	#20
Receptacle	DM51155	DM51155-7	.539 (13.69)	.734 (18.64)	#20

RIGHT ANGLE

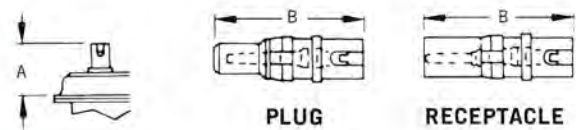

	Part Number		A Max.	B Ref.	Wire Size
	Standard Finish	Military Finish*			
Plug	DM51157-5000	DM51157-5005	.491 (12.47)	.697 (17.70)	#20
Receptacle	DM51155-5000	DM51155-5004	.491 (12.47)	.697 (17.70)	#20

* MIL-C-23308 Finish: 0.00005 (0.00127) minimum gold plate over copper plate (ITT Cannon code A156).

MARK I COAXIAL, HIGH POWER AND HIGH VOLTAGE CONTACTS INSERTION/EXTRACTION

INSERTION

No insertion tool is required. The contact is easily snapped in from the rear of the connector.

RED COLOR CODED CONNECTOR ACCEPTS PLUG CONTACTS.

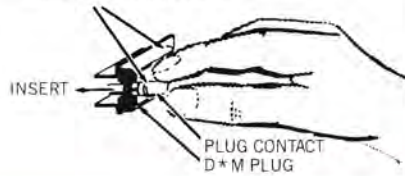

BLUE COLOR CODED CONNECTORS ACCEPTS RECEPTACLE CONTACTS. INSERT FROM TERMINAL END AS SHOWN BELOW.

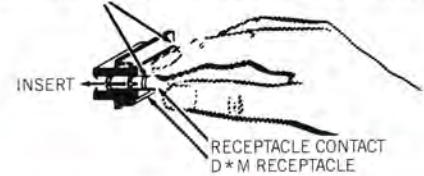

EXTRACTION

CET-C6B

The CET-C6B tool extracts coaxial, high power and high voltage contacts (plug and receptacle). Part number 070064-0000.

OPERATING INSTRUCTIONS:

To extract the coax contact, hold the tool by the body and insert the tip into the front of the contact cavity until it bottoms and closes the coax retaining ring. Holding the body in this position securely enough to keep coax retaining ring closed, push the plunger; contact will be pushed out of the rear of the assembly.



MARK I COAX ASSEMBLY INSTRUCTIONS

TRIM DIMENSIONS

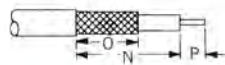

RG Cable No.	Straight			Right Angle		
	N	O	P	N	O	P
196/U, 178B/U 187/U 188/U, 179B/U 316B/U	.312(7.92)	.250(6.35)	.078(1.98)	.375(9.52)	.234(5.94)	.062(1.57)
195/U, 180B/U 58/U, 58B/U	.375(9.52)	.312(7.92)	.078(1.98)	.422(10.69)	.312(7.92)	.094(2.39)

All tolerances $\pm .010(0.25)$

CRIMP TOOLING

RG Cable No.	Tool P/N	Description	Closure
196/U, 178B/U	070051-0000	CCT-DM	C
187/U, 179B/U 188/U, 316B/U	070051-0000	CCT-DM	B
195/U, 180B/U 58/U, 58B/U	070051-0000	CCT-DM	A

ASSEMBLY INSTRUCTIONS

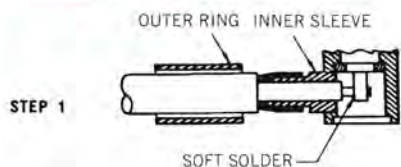

90° COAXIAL

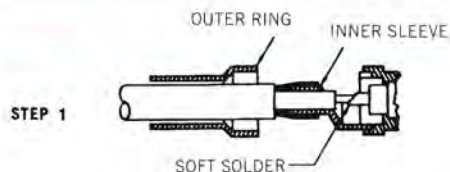
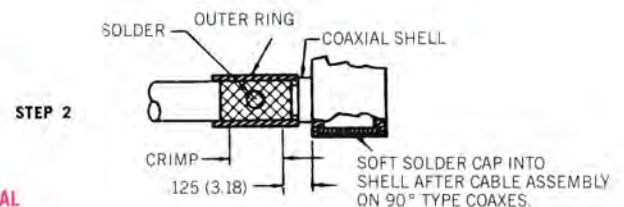

STRAIGHT COAXIAL

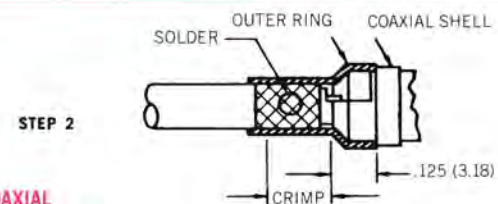

STEP 1: Straight and 90° Coaxials

1. Slide the outer ring over the cable jacket. Trim the cable as specified in the table of Coax Cable Trim Dimensions. Insert the cable dielectric and center conductor into the inside diameter of the inner sleeve. Then solder the center conductor to the coax center contact.

STEP 2: Straight and 90° Coaxials

2. Slide the outer ring forward until it is flush with the coax shell containing the braid between the outer ring and the inner sleeve. For solder type coaxes, soft solder the outer ring to the assembly thru the cross-drilled solder hold. For crimp type coaxes, crimp with the appropriate tool in the area defined.

**MARK III D*MA
QUALIFIED TO M24308**

The D*MA Series is a high reliability connector with crimp, snap-in contacts utilizing the LITTLE CAESAR® contact retention assembly. The Mark III accommodates from #18 AWG through #30 AWG, and is available in 5 shell sizes and 11 insert arrangements including the high density DDMA-78 layout which accommodates 78 #22D contacts. The D*MA Series also accommodates snap-in coaxial, high power and high voltage contacts which are ordered separately. The contacts are used in the combination arrangements shown on page 41.



LITTLE CAESAR® REAR RELEASE CONTACT ASSEMBLY

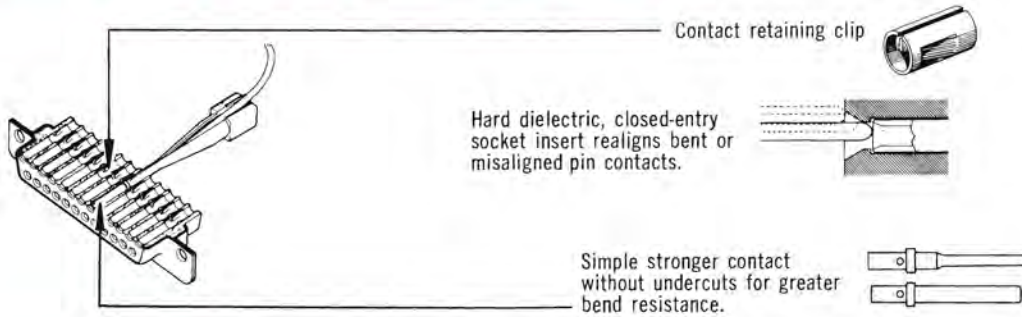

NON-MAGNETIC APPLICATIONS

To order a connector with non-magnetic properties, add the appropriate suffix code to the part number. See page 40 for materials and finishes.

Suffix Code	Residual Magnetism	Shell Plating Finish	Typical Part No.
NM	2000 Gamma	Yellow chromate over cadmium	DBMA-25P-NM
NMB	200 Gamma	Yellow chromate over cadmium	DBMA-25P-NMB
NMB-K47-FO (less contacts)	200 Gamma	Gold over copper	DBMA-25P-NMB-K47-FO
NMB-K52 (with contacts)	200 Gamma	Gold over copper	DBMA-25P-NMB-K52

HOW TO ORDER

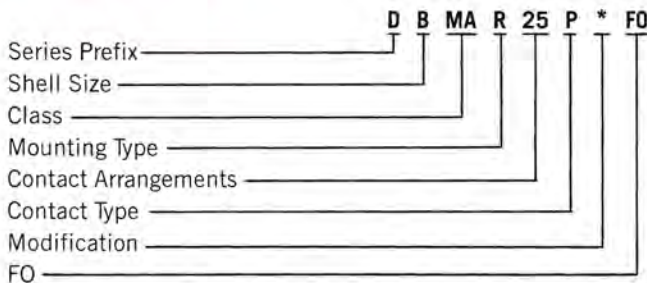

SERIES PREFIX

D — ITT Cannon designation

SHELL SIZE

E, A, B, C and D

CLASS

MA — LITTLE CAESAR rear release contact retention assembly.
MAM — LITTLE CAESAR rear release contact retention assembly; materials, finishes and inspection per MIL-C-24308 as applicable. See page 68 for QPL list.

MOUNTING TYPE

No designator: standard .120 (3.05) diameter mounting hole
E — 4-40 clinch nut for rear panel mounting
F — Float mount for rear panel mounting
K — .154 (3.91) diameter mounting hole
R — Reverse float mount for front panel mounting
Y — Dual float mount for both front and rear panel mounting

CONTACT ARRANGEMENTS

See page 41

CONTACT TYPE

P — Pin; S — Socket

MODIFICATION

See page 62

FO

Connector without contacts (FO will not be printed on the connector)

**STANDARD DATA
MATERIALS AND FINISHES**

	Standard D*MA		M24308 D*MAM		Non-Magnetic	
	Material	Finish	Material	Finish	Material	Finish
Shell	Steel per ASTM-A-620	Yellow chromate over cadmium per QQ-P-416	Same as standard	Same as standard	Brass per QQ-B-613	NM: Yellow chromate over cadmium per QQ-P-416 NMB: Yellow chromate over cadmium per QQ-P-416 K47, K52—A156*
Insulator	Diallyl phthalate per MIL-M-14 type SGD-F, color green	None	Same as standard	None	NM: Same as standard NMB: Diallyl phthalate per MIL-M-14 type SGD-F unmilled, unpigmented color white	None
Contact	Pin: Copper alloy Socket: Copper alloy stainless steel hood	Pin: Gold over nickel Socket: Hood passivated	Same as standard	A156*	NM: Same as standard NMB Pin: Copper alloy Socket: Copper alloy beryllium copper hood	A156* Pin: A156* Socket: A156*
Float Mount Hardware	Stainless Steel	Passivated per QQ-P-35	Same as standard	Same as standard	NM: Same as standard NMB: Brass	Same as standard Same as standard
					K47, K52: Brass	A156*

* A156 Finish: Gold, 50 microinches minimum thickness per MIL-G-45204, Type II Grade C Class 1 over copper per MIL-C-14550.

PERFORMANCE SPECIFICATIONS

	STANDARD ARRANGEMENTS		DDMA-78 ARRANGEMENTS	HIGH POWER CONTACTS		HIGH VOLTAGE CONTACTS	COAXIAL CONTACTS
	Contact Size	AWG		Contact Size	AWG		
Wire Accommodation	2020 2018 2026	20, 22, 24 1 #18 2 #22 26, 28, 30	#22D Contact: 22, 24, 26, 28	0808 0812 0816	#18 #12 #16	#20 Max. (solder cup)	See page 50 for ordering info.
Current Rating	#20 Wire: 5 Amps		#22 Wire: 5 Amps	0808: 40 Amps 0812: 20 Amps 0816: 10 Amps		#20 Wire: 5 Amps	#20 center contacts: 5 Amps
Temperature Rating	-65 °C to +150 °C		-65 °C to +150 °C	-65 °C to +150 °C		-65 °C to +120 °C	-65 °C to +150 °C

DIELECTRIC WITHSTANDING VOLTAGE

All voltages are measured from contact to contact and from contact to shell in unmated condition.

Standard #20 Arrangements	Altitude (feet/m)			
	Sea Level	20,000/6096	50,000/15240	70,000/21336
Average Flashover	1500	1000	500	500
Test	1000	650	325	325

Combination Arrangements		Altitude (feet/m)							
		Sea Level		20,000/6096		50,000/15240		70,000/21336	
Type of Contact		90°	Straight	90°	Straight	90°	Straight	90°	Straight
Center Conductor to Coaxial Shell	Average Flashover	1200	1500	900	1000	600	700	400	500
	Test	800	1000	600	650	400	475	275	325
High Power Contact and/or Coaxial Shell to Plug Shell	Average Flashover	1500	1500	1000	1000	500	500	500	500
	Test	1000	1000	650	650	325	325	325	325
HV Contact to Nearest 20 Contact or to Shell	Average Flashover	3800	3800	2300	2300	900	900	650	650
	Test	2800	2800	1700	1700	675	675	475	475

For additional product specifications please refer to MIL-C-24308 test excerpts page 66.

CONTACT ARRANGEMENTS

BASIC CONTACT ARRANGEMENTS (Face view Pin Insert)

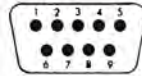

Shell Size
Contact Arrangement
Contact Size

E
9
#20

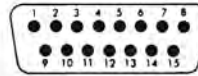

A
15
#20

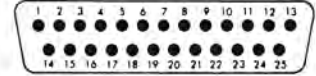

B
25
#20

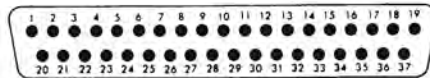

Shell Size
Contact Arrangement
Contact Size

C
37
#20

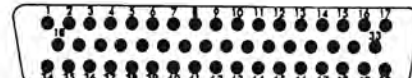

D
50
#20

HIGH DENSITY CONTACT ARRANGEMENT

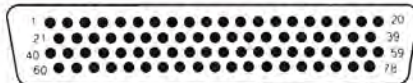

Shell Size
Contact Arrangement
Contact Size

D
78
#22D Contacts only

COMBINATION ARRANGEMENTS NOTE: Color Code — Pin Connector, Red; Socket Connector, Blue
#20 CONTACTS WITH COAX POWER AND/OR HIGH VOLTAGE CONTACTS

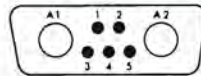

Shell Size
Contact Arrangement
No. of Contacts
Contact Size
Coax or HV Cavities

A
7W2
5
#20
2

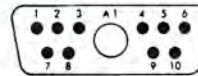

A
11W1
10
#20
1

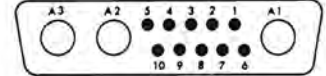

B
13W3
10
#20
3

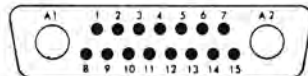

Shell Size
Contact Arrangement
No. of Contacts
Contact Size
Coax or HV Cavities

B
17W2
15
#20
2

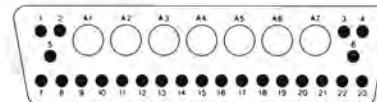

D
30WS7
23
#20
7 shielded contacts only

This layout for
DDMA110335 and DDMA110336
Shielded contacts only (page 44)

STANDARD SHELL

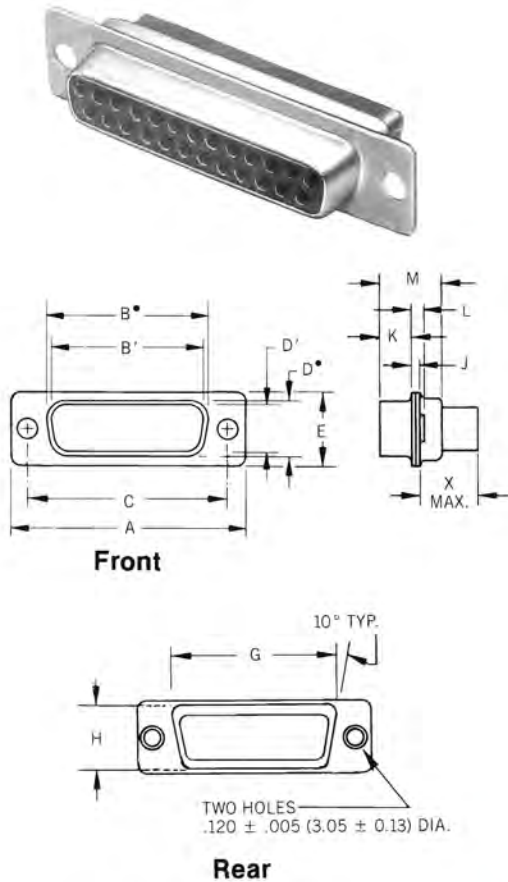

SHELL WITH FLOAT MOUNTS

For shell with float mounts, add letter F after letter C. e.g., DECF9P

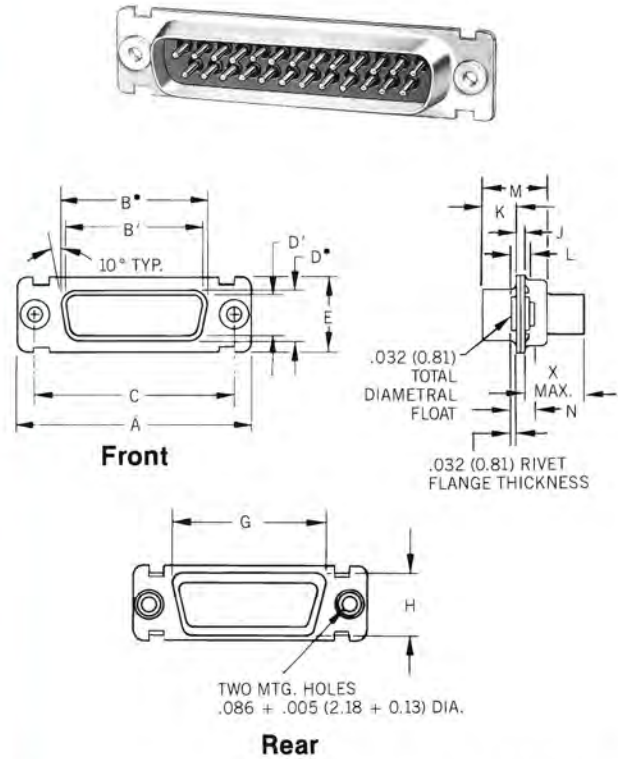

It is recommended that only one assembly, either pin or socket, be float mounted. For front panel mounting use reverse float mount; see page 65.

INCHES

Part Number by Shell Size	A ± .015	B• ± .010	B' ± .010	C ± .005	D• ± .010	D' ± .010	E ± .015	G• ± .010	H• ± .010	J ± .010	K ± .010	L ± .010	M ± .015	N ± .010	X Max.
DEMA-9P	1.213	—	.666	.984	—	.329	.494	.759	.422	.030	.236	.045	.422	.120	.375
DEMA-9S	1.213	.640	—	.984	.308	—	.494	.759	.422	.030	.243	.045	.429	.120	.375
DAMA-15P	1.541	—	.994	1.312	—	.329	.494	1.083	.422	.030	.236	.045	.422	.120	.375
DAMA-15S	1.541	.968	—	1.312	.308	—	.494	1.083	.422	.030	.243	.045	.429	.120	.375
DBMA-25P	2.088	—	1.534	1.852	—	.329	.494	1.625	.422	.039	.231	.060	.426	.129	.375
DBMA-25S	2.088	1.508	—	1.852	.308	—	.494	1.625	.422	.030	.243	.045	.429	.120	.375
DCMA-37P	2.729	—	2.182	2.500	—	.329	.494	2.272	.422	.039	.231	.060	.426	.129	.375
DCMA-37S	2.729	2.156	—	2.500	.308	—	.494	2.272	.422	.030	.243	.045	.429	.120	.375
DDMA-50P	2.635	—	2.079	2.406	—	.436	.605	2.178	.534	.039	.231	.060	.426	.129	.375
DDMA-50S	2.635	2.062	—	2.406	.420	—	.605	2.178	.534	.030	.243	.045	.429	.120	.375

MILLIMETERS

Part Number by Shell Size	A ± 0.38	B' ± 0.25	B• ± 0.25	C ± 0.12	D• ± 0.25	D' ± 0.25	E ± 0.38	G• ± 0.25	H• ± 0.25	J ± 0.25	K ± 0.25	L ± 0.25	M ± 0.38	N ± 0.25	X Max.
DEMA-9P	30.81	—	16.91	24.99	—	8.36	12.55	19.28	10.72	0.76	5.99	1.14	10.72	3.05	9.52
DEMA-9S	30.81	16.25	—	24.99	7.82	—	12.55	19.28	10.72	0.76	6.17	1.14	10.90	3.05	9.52
DAMA-15P	39.14	—	25.24	33.32	—	8.36	12.55	27.51	10.72	0.76	5.99	1.14	10.72	3.05	9.52
DAMA-15S	39.14	24.58	—	33.32	7.82	—	12.55	27.51	10.72	0.76	6.17	1.14	10.90	3.05	9.52
DBMA-25P	53.03	—	38.96	47.04	—	8.36	12.55	41.27	10.72	0.99	5.87	1.52	10.82	3.28	9.52
DBMA-25S	53.03	38.30	—	47.04	7.82	—	12.55	41.27	10.72	0.76	6.17	1.14	10.90	3.05	9.52
DCMA-37P	69.31	—	55.42	63.50	—	8.36	12.55	57.71	10.72	0.99	5.87	1.52	10.82	3.28	9.52
DCMA-37S	69.31	54.76	—	63.50	7.82	—	12.55	57.71	10.72	0.76	6.17	1.14	10.90	3.05	9.52
DDMA-50P	66.92	—	52.81	61.11	—	11.07	15.37	55.32	13.56	0.99	5.87	1.52	10.82	3.28	9.52
DDMA-50S	66.92	52.37	—	61.11	10.67	—	15.37	55.32	13.56	0.76	6.17	1.14	10.90	3.05	9.52

• Dimensions B, D, G, and H are measured as outside dimensions at the bottom of the draw.
NOTE: B• and D• are the O.D. dims. for socket side, B' and D' are the I.D. dims. for pin side.

CONTACTS

CRIMP TYPE CONTACTS

Contact Size	Wire Size Accom.	Standard Finish		Military Finish	
		Pin	Socket	Pin	Socket
20	20, 22, 24	330-5291-000	031-1007-000	330-5291-037	031-1007-042
20-18	1 #18 & 2 #22	330-5291-001	031-1007-001	330-5291-055	031-1007-054
20-26	26, 28, 30	330-5291-004	031-1007-004	330-5291-050	031-1007-048
22D	22, 24, 26, 28			030-2042-002	031-1147-002

MIL-C-39029 CROSS-REFERENCE

Contact Size	Wire Accom.	M39029	M24308*	Cannon Part No.
20 Pin	20/22/24	/64-369	/11-1	330-5291-037
20 Socket	20/22/24	/63-368	/10-1	031-1007-042
22D Pin 23	24/26/28	/58-360	/13-1	030-2042-000
22D Socket	22/24/26/28	/57-354	/12-1	031-1147-000

* Superseded by M39029

TOOLING

INSERTION/EXTRACTION TOOLS



CIET-20-HD

Contact Size	AWG	Plastic Insertion/Extraction		Plastic Extraction	
		Part No.	Description	Part No.	Description
20	20, 22, 24	274-7006-000	CIET-20HD	323-7010-000	CET-20-11
2026	26, 28, 30	274-7006-000	CIET-20HD	323-7010-000	CET-20-11
2018	1 #18	None	None	274-5016-002	CET-20-15
	2 #22	None	None	274-5016-002	CET-20-15
22D	22, 24, 26, 28	274-7048-000	CIET-22D	None	None
High Power	12, 16	274-7003-000	CIET-12	None	None
High Volt	#20	274-7003-000	CIET-12	None	None

HAND CRIMP TOOLS



M22520/1-01



M22520/2-01

Contact Size	AWG	Crimp Tool		Locator	
		Part No.	Description	Part No.	Description
20	20, 22, 24	995-0001-584	M22520/2-01	995-0001-604	M22520/2-08
		995-0001-585	M22520/1-01	995-0001-244	TH25
		995-0001-584	M22520/2-01	995-0001-325	L3198-20HD
2018	1 #18 2 #22	995-0001-584	M22520/2-01	980-0005-722	K250
		995-0001-584	M22520/2-01	995-0001-739	M22520/2-06

SEMI-AUTOMATIC CRIMP MACHINES



CBT-491

For volume applications the CBT-491 is a vibra-bowl, pneumatically operated crimper offering a more economical approach than belt-fed crimpers. Available for lease or purchase, this machine is designed for use with a wide variety of machined contacts. The MIL-Spec crimp is accomplished at the press of a foot pedal, assuring minimum cycle times and maximum performance.

For lower volumes the CBT-565 is a pneumatically operated bench tool delivering MIL-Spec crimps with minimal operator fatigue.

When you think crimp think Cannon!

ASSEMBLY INSTRUCTIONS

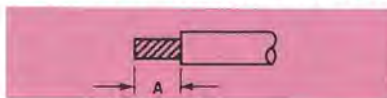

	Min.	Max.
D*MA	.188 (4.78)	.208 (5.28)

1. Cut wires to length. Strip insulation per above illustration. Check for broken or frayed wires.

CONTACT CRIMPING



2. Insert contact and wire into proper crimp tool (and locator, if required). Crimp contact to wire. Inspect crimp.

CONTACT INSERTION



3. Center wired contact in groove of insertion tool (for size 22D also, D*MA) with tool tip butting contact shoulder. Insert contact into cavity until a positive stop is felt. Inspect insertion.

CONTACT EXTRACTION



5. Place wire into extraction tool tip. (See above for D*MA extraction).



6. Insert tool tip into contact cavity until tip bottoms against contact shoulder, releasing tines. Hold wire against tool with finger and remove tool and contact. Repeat for balance of contacts.



4. To be sure contact is locked securely, pull back lightly on wire. Repeat for balance of contacts, working row by row across the insulator.

COAXIAL, HIGH POWER AND HIGH VOLTAGE CONTACTS

For coax. assembly instructions and insertion/extraction see page 45.

MARK III COAXIAL CONTACTS

Color Code: Receptacle - Blue; Plug - Red

STRAIGHT CRIMP BRAID

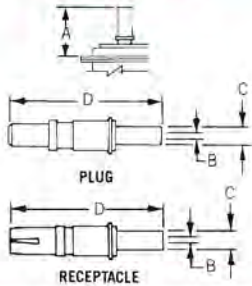

	Part Number		A	B	C	D	RG Cable No.	
	Std. Finish	Mil. Finish*	Max.	± .005 (0.12)	± .005 (0.12)	Ref.	Old	New
Plug	DMA43717	DMA43717-4	.805(20.44)	.040(1.02)	.125(3.18)	1.019(25.88)	196/U	178B/U
Plug	DMA43717-1	DMA43717-5	.805(20.44)	.067(1.70)	.156(3.96)	1.019(25.88)	187/U 188/U	316B/U 179B/U
Plug	DMA43717-2	DMA43717-6	.805(20.44)	.110(2.79)	.235(5.97)	1.019(25.88)	195/U	180B/U
Plug	DMA43717-3	DMA43717-7	.805(20.44)	.125(3.18)	.235(5.97)	1.019(25.88)	58/U	58B/U
Receptacle	DMA43716	DMA43716-4	.805(20.44)	.040(1.02)	.125(3.18)	1.006(25.55)	196/U	178B/U
Receptacle	DMA43716-1	DMA43716-5	.805(20.44)	.067(1.70)	.156(3.96)	1.006(25.55)	187/U 188/U	316B/U 179B/U
Receptacle	DMA43716-2	DMA43716-6	.805(20.44)	.110(2.79)	.235(5.97)	1.006(25.55)	195/U	180B/U
Receptacle	DMA43716-3	DMA43716-7	.805(20.44)	.125(3.18)	.235(5.97)	1.006(25.55)	58/U	58B/U

RIGHT ANGLE CRIMP BRAID

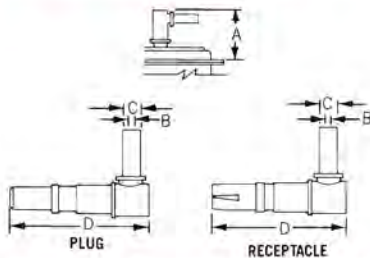

	Part Number		A	B	C	D	RG Cable No.	
	Std. Finish	Mil. Finish*	Max.	± .005 (0.12)	± .005 (0.12)	Ref.	Old	New
Plug	DMA43719	DMA43719-4	.703(17.85)	.040(1.02)	.125(3.18)	.922(23.42)	196/U	178B/U
Plug	DMA43719-1	DMA43719-5	.703(17.85)	.067(1.70)	.156(3.96)	.922(23.42)	187/U 188/U	316B/U 179B/U
Plug	DMA43719-2	DMA43719-6	.703(17.85)	.110(2.79)	.235(5.97)	.922(23.42)	195/U	180B/U
Plug	DMA43719-3	DMA43719-7	.703(17.85)	.125(3.18)	.235(5.97)	.922(23.42)	58/U	58B/U
Receptacle	DMA43718	DMA43718-4	.703(17.85)	.040(1.02)	.125(3.18)	.910(23.11)	196/U	178B/U
Receptacle	DMA43718-1	DMA43718-5	.703(17.85)	.067(1.70)	.156(3.96)	.910(23.11)	187/U 188/U	316B/U 179B/U
Receptacle	DMA43718-2	DMA43718-6	.703(17.85)	.110(2.79)	.235(5.97)	.910(23.11)	195/U	180B/U
Receptacle	DMA43718-3	DMA43718-7	.703(17.85)	.125(3.18)	.235(5.97)	.910(23.11)	58/U	58B/U

MARK III HIGH VOLTAGE CONTACTS

STRAIGHT

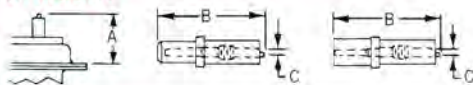

	Part Number		A	B	C	Wire Size	Extraction Tool
	Std. Finish	Mil. Finish*	Max.	Ref.	± .005 (0.12)		
Plug	DMA44157	DMA44157-2	.539(13.70)	.734(18.60)	.045(1.10)	20	274-7003-000
Receptacle	DMA44159	DMA44159-2	.539(13.70)	.734(18.60)	.045(1.10)	20	274-7003-000

*MIL-C-24308 Finish: 0.00005/0.00127 Minimum Gold Plate over Copperplate (ITT Cannon Code A156)

MARK III POWER CONTACTS

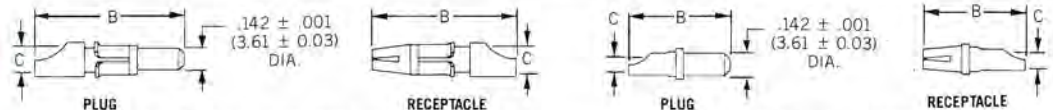

(Size 0808 Wire Accommodation)

(Size 0812 and 0816 Wire Accommodation)

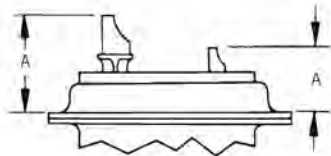

	Part Number		A	B	C	Wire Size	Current Rating (Amps)	Extraction Tool
	Standard Finish	Military Finish*	Max.	Ref.	+ .005(0.13) - .004(0.10)			
Plug	DMA44348	DMA44348-1	.800(20.32)	1.000(25.40)	.188(4.78)	#8	40	None Req'd.
Plug	DMA44349	DMA44349-1	.500(12.70)	.697(17.70)	.112(2.84)	#12	20	274-7003-000
Plug	DMA44350	DMA44350-1	.500(12.70)	.697(17.70)	.069(1.75)	#16	10	274-7003-000
Receptacle	DMA44351	DMA44351-1	.800(20.32)	.993(25.22)	.188(4.78)	#8	40	None Req'd.
Receptacle	DMA44352	DMA44352-1	.500(12.70)	.690(17.53)	.112(2.84)	#12	20	274-7003-000
Receptacle	DMA44353	DMA44353-1	.500(12.70)	.690(17.53)	.069(1.75)	#16	10	274-7003-000

*MIL-C-24308 Finish: 0.00005/0.00127 Minimum Gold Plate over Copperplate (ITT Cannon Code A156)

MARK II SHIELDED #16 CONTACTS

Crimp Inner Contact and Outer Shell (for use with 30WS7 layout only).

Consult factory for tooling information

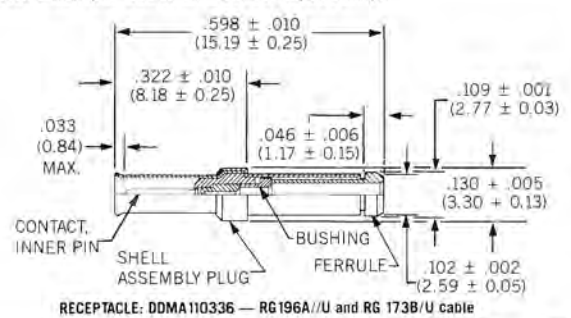
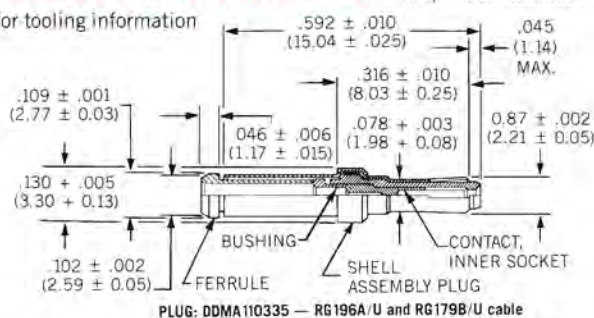

(millimeters are in parentheses)

**MARK III
COAXIAL, HIGH POWER AND HIGH VOLTAGE CONTACTS INSERTION/EXTRACTION**

INSERTION

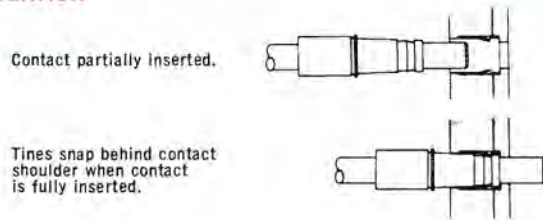

No insertion tools are required for the coaxial contact, size 8 high power contacts, and sizes 12 and 16 high power and high voltage contacts.

Insertion Procedure:

Push the contact into the rear of the connector. Tines will snap behind the contact shoulder when the contact is fully inserted.

EXTRACTION

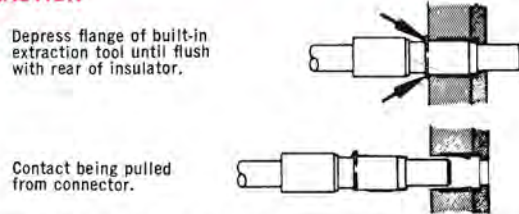

A separate extraction tool is not required for the coaxial contact or the size 8 high power contacts. The tool is an integral part of the contact.

Extraction Procedure:

Depress flange of built-in extraction tool until it is flush with the rear of the insulator. Contact can then be pulled from the connector. For extraction of sizes 12 and 16 high power and high voltage contacts the extraction tool 274-7003-000 is recommended.

**MARK III
COAX CABLE ASSEMBLY**

TRIM DIMENSIONS

Trim coaxial cable to these dimensions for installation to D*MA coaxial contacts.

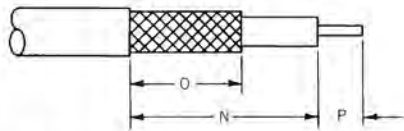

Contact Type	N	O	P
Straight	.354(8.99)	.190(4.83)	.090(2.29)
Right Angle	.316(8.03)	.190(4.83)	.062(1.57)

CRIMP TOOLING

RG Cable No.	Tool P/N	Description	Closure	
196/U 187/U 188/U	178 B/U 179 B/U 316 B/U	070051-0000	CCT-DM CCT-DM CCT-DM	C B
195/U 58/U	180 B/U 58 B/U	070051-0000	CCT-DM	A

ASSEMBLY INSTRUCTIONS

STRAIGHT COAXIAL

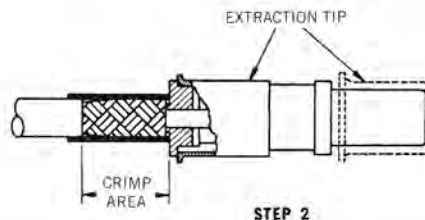
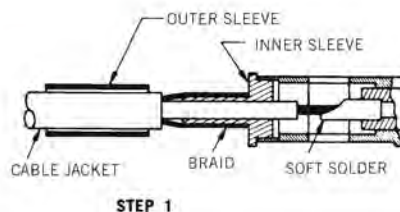

Straight Type:

STEP 1

Slide outer sleeve over cable jacket and trim cable. Insert cable dielectric and center conductor into inside dimension of inner sleeve. Solder center conductor to coaxial center contact.

STEP 2

Slide outer sleeve forward until flush with inner sleeve to confine braid. Crimp outer sleeve, using crimp tool CCT-DM. Crimp as close as possible to the inner sleeve shoulder. Push extraction tip over the coaxial (as shown) until it rests against the inner sleeve shoulder.

90° COAXIAL

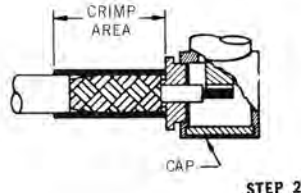
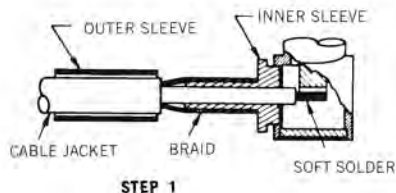

90° Angle Type

STEP 1

Slide outer sleeve over cable jacket and trim cable. Insert cable dielectric and center conductor into inside dimension of inner sleeve. Solder center conductor to coaxial center contact.

STEP 2

Slide outer sleeve forward until flush with coaxial shell, confining braid between outer and inner sleeves. Crimp in area shown. Soft solder cap in place.

GROMMET-D

GD* connectors are ideal for aerospace, military, telecommunications and other applications requiring environmental protection and high reliability.

ITT Cannon developed GD* connectors to meet the needs of the avionics industry. These connectors provide high-density and moisture protection.

Environmental protection is accomplished by the resilient grommet, interfacial seal, and bonded connector components.

ITT Cannon is the first and only connector manufacturer to offer a crimp-removeable environmental series with M24308 compatibility.

- Environmental Protection
- MIL-C-24308 Compatibility
- Reliability and Versatility



DESIGN FEATURES

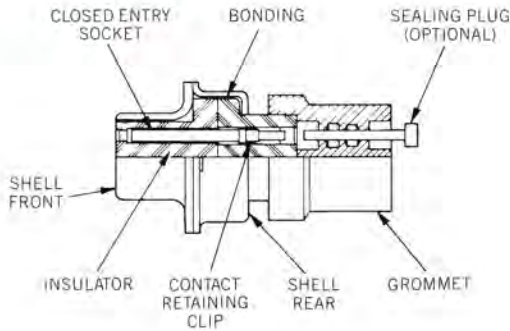

SOCKET CONNECTOR

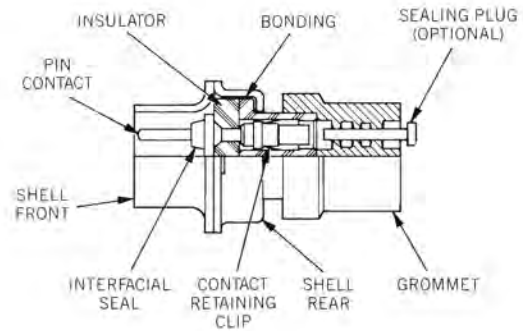

PIN CONNECTOR

- Resilient silicone grommets for wire sealing
- Interfacial seals
- Closed-entry socket contacts
- Bonded components to prevent moisture seepage
- Optional sealing plugs

- Uses M39029 type contacts and termination tooling
- Intermateable with most M24308 type connectors
- Rear-release cimp contacts
- LITTLE CAESAR® contact retention assembly

PRINTED CIRCUIT APPLICATIONS

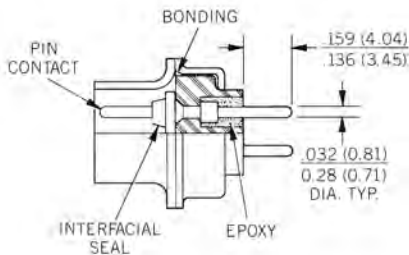

GD* Pin connectors are available with pre-loaded, non-removeable contacts for P.C. board termination. Typical Part No. GDB-25PB. Environmental sealing is accomplished by application of epoxy to each contact cavity, interfacial seals, and bonded connector components.

STANDARD DATA MATERIALS AND FINISHES

	Materials	Finishes
Shell	Low carbon steel per ASTM-A-620	Cadmium per QQ-P-416
Insulator	Diallyl phthalate per MIL-M-14 type SDG-F or GDI-30F	—
Contacts	Copper alloy	Standard finish: Gold over nickel A156 Finish: Gold over copper per MIL-C-24308
Float Mount Hardware	Stainless steel	Passivated
Grommets and Seals	Silicone elastomer	
Bonding Materials	Epoxy	—

MECHANICAL FEATURES

Wire Accommodation — Contact: #20, #22, #24 AWG (.071 (1.80) maximum, .038 (0.97) minimum, O.D. wire)

Contact Retention — 9 lbs. minimum (40N) after 10 insertions

ELECTRICAL DATA

Test Voltage AC RMS 60 Hz

	Sea Level	20,000 Ft.	50,000 Ft.	70,000 Ft.
Average Flashover	1,000	1,000	500	500
Test	1,000	650	325	325

Maximum Current Carrying Capacity of Contacts —

#20 Contacts: 5 Amps

Temperature Range — -65°C to +150°C (-53.9°F to +302°F)

HOW TO ORDER

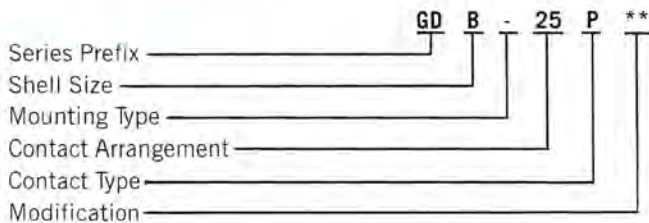

SERIES PREFIX

GD — Grommet D

SHELL SIZE

E, A, B, D

MOUNTING TYPE

No Designator — .120 (3.05) Diameter Mounting Holes

F — Float Mount for Rear Panel Mounting

K — .154 (3.91) Diameter Mounting Holes

CONTACT ARRANGEMENTS

9, 15, 25, and 50

CONTACT TYPE

P — Pin, crimp termination

S — Socket, crimp termination

PB — Pin, printed circuit termination with non-removeable straight tails for .125 (3.18) maximum P.C. Board Thickness

MODIFICATIONS (Typical Modifiers)

FO — Connectors supplied Less Contacts

A156 — Connectors supplied with contacts plated per MIL-G-45204 Type II Class 1 (M24308 Finish)

PERFORMANCE SPECIFICATIONS

GD* Connectors meet all applicable requirements of MIL-C-24308. The following are excerpts from ITT Cannon Test Report C82-78 applicable to environmental D Subminiature GD* series connectors. Refer to MIL-C-24308 Test Extracts on page 67.

Test Description	Test Method	Results
Moisture Resistant	MIL-STD-1344 Method 1002.1 Type II	1. No deterioration of performance. 2. Insulation resistance greater than 100 megohms. 3. No evidence of flashover or breakdown during 1000 VAC DWV testing.
Fluid Immersion	20 hours immersion in hydraulic fluid per MIL-H-5606 and lubricating fluid per MIL-L-23699.	1. No detrimental damage. 2. Able to meet requirements of mating and unmating forces test.
Immersion	Two hours immersion in tap water at a depth of 36.00 (914.40) in mated condition, per MIL-STD 810, Method 512, Procedure 1.	While still immersed, the mated connectors exceeded 100 megohm insulator resistance and exhibited no evidence of breakdown or flashover during 1000 VAC (RMS) DWV testing.

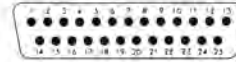
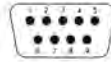
CONTACT ARRANGEMENTS (FACE VIEW PIN INSERT)

Shell Size	E	A	B	D
Contact Arrangement	9	15	25	50
Contact Size	#20	#20	#20	#20

ACCESSORIES

SEALING PLUGS: GD* grommets are designed to accept MS27488-20 sealing plugs, ITT Cannon P/N 225-0070-000 ordered separately.

LOCKING HARDWARE, DUST CAPS: GD* Connectors will accommodate most standard D Subminiature accessories.

JUNCTION SHELLS: Consult factory. Junction shell ordering information is found in the accessories section of the catalog, see pages 56-59.

CONTACTS

Finish	Type	ITT Cannon Part Number	Military Part Number
Standard	Pin #20	330-5291-000	
Gold/Nickel	Socket #20	031-1007-000	
A156	Pin #20	330-5291-037	M39029/64-369
Gold/Copper	Socket #20	031-1007-042	M39029/63-368

TOOLING
HAND CRIMP TOOLS

M22520/2-01

M22520/2-01 with M22520/2-08 locator. Semi-automatic and fully automatic tooling is also available.

INSERTION/EXTRACTION TOOL (Plastic)

Contact Size	ITT Cannon Description	ITT Cannon Part Number	Insertion Color Tip	Extraction Color Tip
#20	CIET-20HDL	274-7010-000	White	Green

SHELL DIMENSIONS

STANDARD SHELL

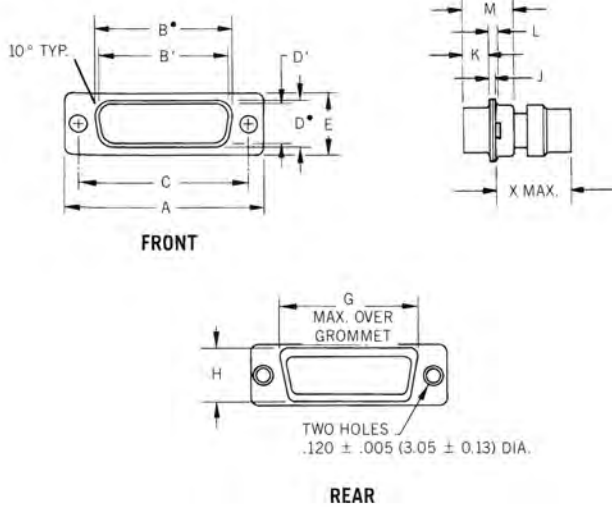

SHELL WITHOUT FLOAT MOUNTS

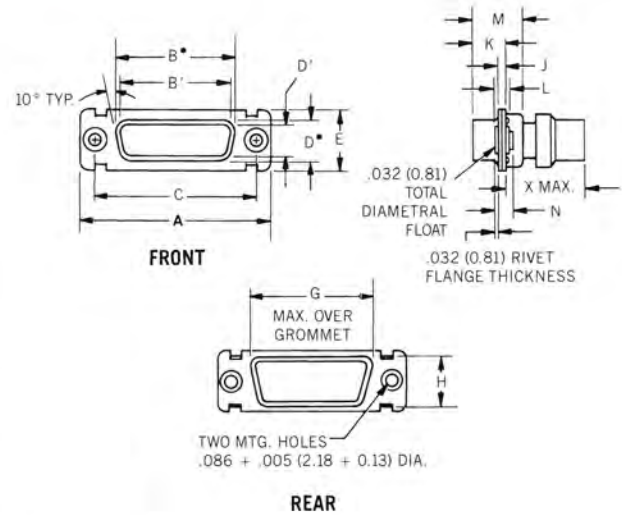

It is recommended that only one assembly, either pin or socket, be float mounted. For front panel mounting use reverse float mount.

INCHES

Part Number by Shell Size	A ± .015	B• ± .010	B' ± .010	C ± .005	D• ± .010	D' ± .010	E ± .015	G Max.	H• ± .010	J ± .010	K ± .010	L ± .010	M ± .015	N ± .010	X Max.
GDE-9P	1.213	—	.666	.984	—	.329	.494	.750	.422	.030	.236	.045	.422	.120	.718
GDE-9S	1.213	.640	—	.984	.308	—	.494	.750	.422	.030	.243	.045	.429	.120	.718
GDA-15P	1.541	—	.994	1.312	—	.329	.494	1.093	.422	.030	.236	.045	.422	.120	.718
GDA-15S	1.541	.958	—	1.312	.308	—	.494	1.093	.422	.030	.243	.045	.429	.120	.718
GDB-25P	2.088	—	1.534	1.852	—	.329	.494	1.625	.422	.039	.231	.060	.426	.129	.718
GDB-25S	2.088	1.508	—	1.852	.308	—	.494	1.625	.422	.030	.243	.045	.429	.120	.718
GDD-50P	2.635	—	2.079	2.406	—	.436	.605	2.162	.534	.039	.231	.060	.425	.129	.718
GDD-50S	2.635	2.062	—	2.406	.420	—	.605	2.162	.534	.030	.243	.045	.429	.120	.718

MILLIMETERS

Part Number	A ± 0.38	B• ± 0.25	B' ± 0.25	C ± 0.12	D• ± 0.52	D' ± 0.38	E ± 0.38	G Max.	H• ± 0.25	J ± 0.25	K ± 0.25	L ± .025	M ± 0.38	N ± 0.25	X Max.
GDE-9P	30.81	16.91	—	24.99	—	8.36	12.55	19.05	10.72	0.76	5.99	1.14	10.72	3.05	18.24
GDE-9S	30.81	—	16.25	24.99	7.82	—	12.55	19.05	10.72	0.76	6.17	1.14	10.90	3.05	18.24
GDE-15P	39.14	25.24	—	33.32	—	8.36	12.55	27.76	10.72	0.76	5.99	1.14	10.72	3.05	18.24
GDA-15S	39.14	—	24.58	33.32	7.82	—	12.55	27.76	10.72	0.76	6.17	1.14	10.90	3.05	18.24
GDB-25P	53.03	38.96	—	47.04	—	8.36	12.55	41.28	10.72	0.99	5.87	1.52	10.82	3.28	18.24
GDB-25S	53.03	—	38.30	47.04	7.82	—	12.55	41.28	10.72	0.76	6.17	1.52	10.90	3.05	18.24
GDD-50P	66.92	52.81	—	61.11	—	11.07	15.37	54.91	13.56	0.99	5.87	1.52	10.82	3.28	18.24
GDD-50S	66.92	—	52.37	61.11	10.87	—	15.37	54.91	13.56	0.76	6.17	1.52	10.90	3.05	18.24

* Dimensions B, D, G, and H are measured as outside dimensions at the bottom of draw.

NOTE: B• and D• are the outside dimensions for socket side, B' and D' are the inside dimensions for pin side.

BULKHEAD

The D*BMA feed-thru bulkhead connector is used when it is desirable to connect and disconnect a cable on both sides of a bulkhead or panel. This connector can also be used as a connector saver in test equipment applications where more than normal mating and unmating would soon degrade a permanently mounted connector. It features the industry proven LITTLE CAESAR® rear release contact retention assembly, making it field repairable.

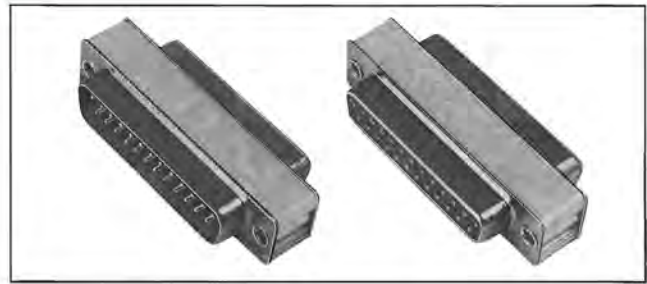

HOW TO ORDER

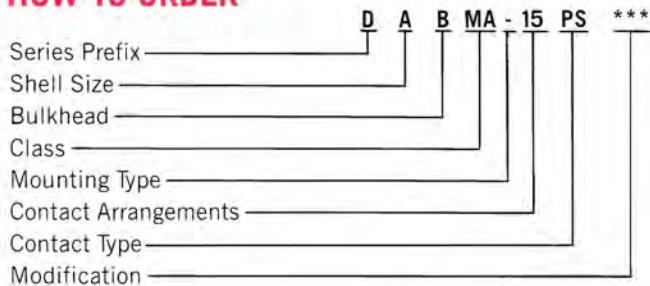

SERIES PREFIX

D — ITT Cannon Designation

SHELL SIZE

E, A, B, C and D

BULKHEAD

B

CLASS

MA — LITTLE CAESAR rear release contact retention assembly

MOUNTING TYPE

No designator — 120 (3.05) thru hole

N — #4-40 UNC-2B thru threads

CONTACT ARRANGEMENTS

9, 15, 25, 37 and 50 (See page 48)

CONTACT TYPE

PS — Pin/Socket

MODIFICATION

See page 72 for modification codes

SHELL DIMENSIONS

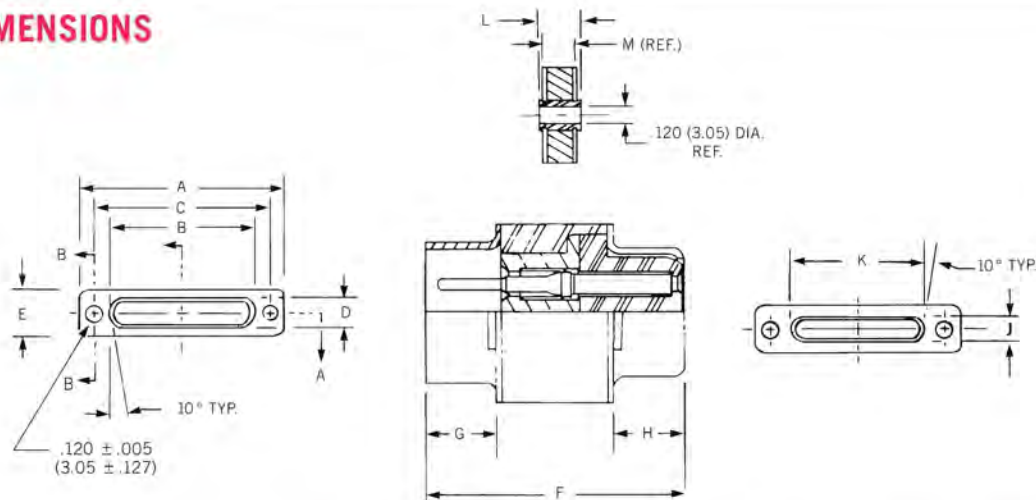

INCHES

Part Number by Shell Size	A	B	C	D	E	F	G	H	J	K	L	M
DEBMA-9PS	± .015	± .010	± .005	± .010	± .015	± .010	± .010	± .010	± .010	± .010	± .015	± .010
DABMA-15PS	1.213	.697	.984	.360	.494	.861	.236	.243	.308	.640	.417	.388
DABMA-15PS	1.541	1.025	1.312	.360	.494	.861	.236	.243	.308	.968	.417	.388
DBBMA-25PS	2.088	1.583	1.852	.378	.494	.865	.231	.243	.308	1.508	.417	.388
DCBMA-37PS	2.729	2.231	2.500	.378	.494	.865	.231	.243	.308	2.156	.417	.388
DBBMA-50PS	2.635	2.127	2.406	.484	.605	.865	.231	.243	.420	2.062	.417	.388

MILLIMETERS

Part Number by Shell Size	A	B	C	D	E	F	G	H	J	K	L	M
DEBMA-9PS	± 0.38	± 0.25	± 0.13	± 0.25	± 0.38	± 0.25	± 0.25	± 0.25	± 0.25	± 0.25	± 0.38	± 0.25
DEBMA-9PS	30.81	17.70	24.99	9.14	12.55	21.87	5.99	6.17	7.82	16.26	10.59	9.86
DABMA-15PS	39.14	26.04	33.32	9.14	12.55	21.87	5.99	6.17	7.82	24.59	10.59	9.86
DBBMA-25PS	53.04	40.21	47.04	9.60	12.55	21.97	5.87	6.17	7.82	38.30	10.59	9.86
DCBMA-37PS	69.29	56.67	63.50	9.60	12.55	21.97	5.87	6.17	7.82	54.76	10.59	9.86
DBBMA-50PS	66.93	54.03	61.11	12.29	15.37	21.97	5.87	6.17	10.67	52.37	10.59	9.86

D*D ENVIRONMENTAL

The Cannon D*D Environmental Series is designed to meet the demand for sealed subminiature rectangular plugs with superior vibration and moisture resistance characteristics for aircraft, missile, and ground support equipment applications.

Featuring a rugged aluminum shell and peripheral seal, the D*D Connector meets all applicable requirements of MIL-C-24308. Available in both solder and crimp versions, all assemblies are provided with nylon potting cups and dust caps.

Solder type contacts are non-removable and are factory-installed. Crimp type connectors utilize the field-proven LITTLE CAESAR rear insertion, rear-release retention system.

PLEASE NOTE: The D*D Series is not intermateable with other D Subminiature connectors.



STANDARD DATA

Shell	Aluminum, cadmium plated with yellow chromate supplementary coating.
Contacts	Solder pot: Copper alloy, gold plated .00002 (0.0005) over nickel .00004 (0.0010). Crimp type: Copper alloy, gold plated .00002 (0.0005) over nickel .00004 (0.0010).
Insulator	Diallylphthalate, per MIL-M-14, Type MDG or SDG-F.
Contact Termination	Solder pot accommodating up to #20 AWG stranded wire. Crimp type accommodating #20, #22, and #24 AWG stranded wire.
Socket Type	Closed entry
Float Mounting Rivets & Washers	Stainless steel

TEST DATA

	Specifications
Voltage Rating	All voltage figures are AC (rms), 60 cps. measured at approximately 25.0°C 50% RH.
Insulation Resistance (per MIL-C-24308)	Greater than 5,000 megohms, determined in accordance with MIL-STD-202A, Method 302.
Contact Voltage Drop	2.67 millivolts, maximum, per amp.
Contact Separation Force	1 to 8 ounces when tested in accordance with MIL-C-24308.
Air Leakage	When properly wired and potted, 1 cubic inch of air per hour max. when subjected to 30 PSI pressure differential in accordance with MIL-C-5015D, Paragraph 4.5.3.1.
Vibration (per MIL-C-24308)	Exceeds test requirements of MIL-STD-202A, Method 204, Condition D. †
Corrosion Resistance (per MIL-C-24308)	Exceeds requirements of 50 hour exposure to salt spray in accordance with MIL-STD-202A, Method 101A, Condition B.
Moisture Resistance (per MIL-C-24308)	Exceeds requirements of MIL-STD-202A, Method 106.
Shock	Exceeds requirements of MIL-STD-202A, Method 213, Condition G.
Environmental Seal	Effective from full engagement to 1/16 short of full engagement.
Contact Retention Force	(Crimp type) 8 pounds (35.6 newtons) minimum for first cycle; 5 pounds (22.2 newtons) minimum after tenth cycle.
Standard Layout Plugs	Measured from contact-to-contact, and contact-to-shell in unmated condition.

	ALTITUDE (FEET)			
	Sea Level	20,000	50,000	70,000
Average Flash-over	1700	1000	650	500
Test	1250	750	475	375

HOW TO ORDER

SOLDER CUP TERMINALS

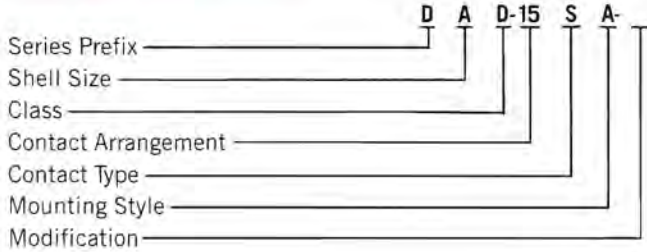

- SERIES PREFIX**
ITT Cannon Designation
- SHELL SIZE**
A, B, C, D, E
- CLASS**
D — Environmental
- CONTACT ARRANGEMENT**
9, 15, 25, 37, 50
- CONTACT TYPE**
P — Pin
S — Socket
- MOUNTING STYLE**
A — Standard mounting holes
B — Float mounts supplied
- MODIFICATION**
Consult factory

SNAP-IN CRIMP TERMINALS

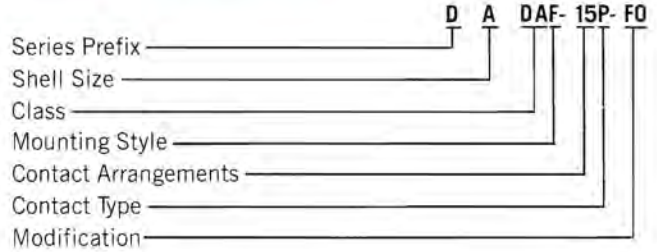

- SERIES PREFIX**
ITT Cannon Designation
- SHELL SIZE**
A, B, C, D, E
- CLASS**
DA — Environmental, crimp type
- MOUNTING STYLE**
No Designator — Standard mounting
F — Float mounts supplied
- CONTACT ARRANGEMENTS**
9, 15, 25, 37, 50
- CONTACT TYPE**
P — Pin
S — Socket
- MODIFICATION**
FO — Connector supplied less contacts, for other modifications consult factory

CONTACT ARRANGEMENTS (Face View Pin Insert)

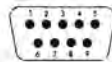

Shell Size
Contact Arrangement
Contact Size

E
9
#20



A
15
#20

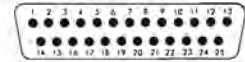

B
25
#20



Shell Size
Contact Arrangement
Contact Size

C
37
#20

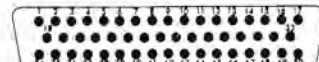

D
50
#20

MOUNTING DIMENSIONS

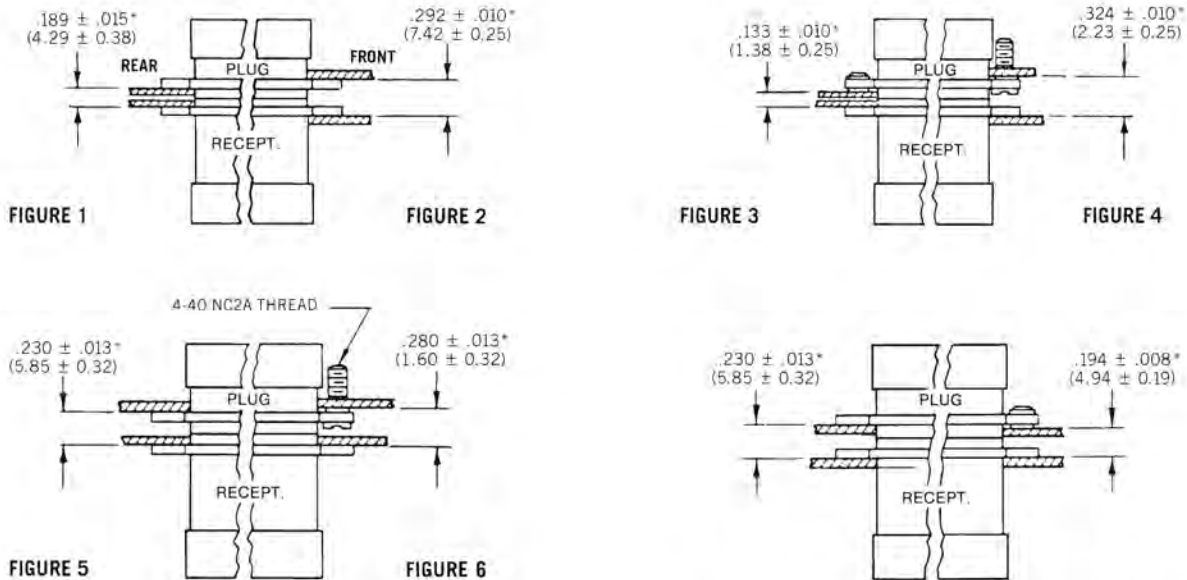

NOTE: Max panel thickness is .125(3.17) for non-floating rear panel mounting.

1. With both connectors rear mounted, use #4-40 flat head screws flush with the panel (Fig. 1).
2. With both connectors front mounted, use #4-40 binder or pan head screws (Fig. 2).
3. With both connectors rear mounted (float rivets on plug assembly side), use #4-40 flat head screws, flush with the panels (Fig. 3).
4. With both connectors front mounted (plug assembly has float mounting screw), use #4-40 binder or pan head screws for receptacle assembly (Fig. 4).
5. With plug assembly front mounted and receptacle assembly rear mounted, use hardware from Figures 1 and 2.

6. With plug assembly front mounted and receptacle assembly rear mounted (plug assembly has float mounting screw), use hardware from Figure 1 for receptacle assembly.

*Dimensions between panels represent the recommended limit to be used in the design of the connector mounting method.

7. With plug assembly rear mounted and receptacle assembly front mounted, use hardware from Figures 1 and 2.
8. With plug assembly rear mounted (float rivets) and receptacle assembly front mounted, use hardware from Figures 2 and 3.
9. Electrical contact engagement when mounted per Figure 1 is .046 (1.17) min./ .070 (1.78) max.

NOTE: Float rivets are for rear mounting only and float screw for front mounting only. (Specify when ordering.)

PANEL CUTOUTS

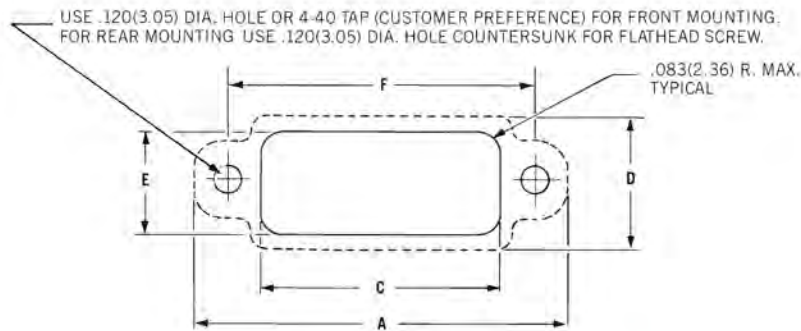

Shell Size	A ± .010	C Min.	D ± .010	E Min.	F ± .006
DED-9	1.442(36.63)	.839(21.31)	.614(15.60)	.497(12.62)	1.125(28.58)
DAD-15	1.755(44.58)	1.157(29.39)	.614(15.60)	.497(12.62)	1.437(36.50)
DBD-25	2.295(58.29)	1.697(43.10)	.614(15.60)	.497(12.62)	1.993(50.62)
DCD-37	2.937(74.60)	2.357(59.87)	.614(15.60)	.497(12.62)	2.625(66.68)
DDD-50	2.859(72.62)	2.265(57.53)	.735(18.67)	.610(15.49)	2.531(64.29)

Add .032(0.81) to dimensions C and E for float mounting.
Note: Panel cutout does not allow for potting cup clearance.

SHELL DIMENSIONS

STANDARD MOUNT

RECEPTACLE

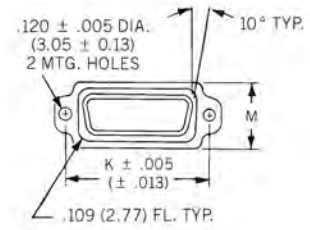
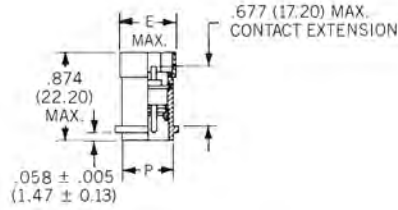
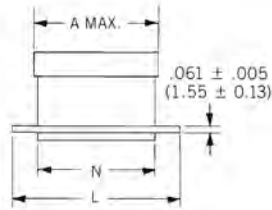

PLUG

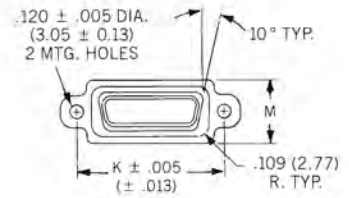
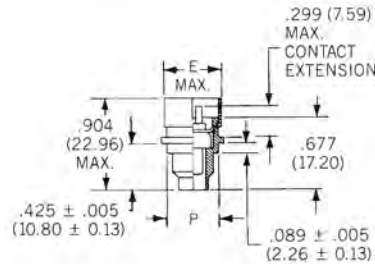
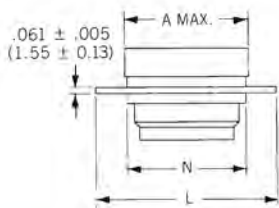

FLOAT MOUNT

RECEPTACLE

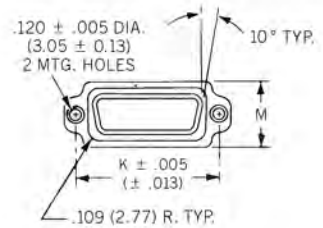
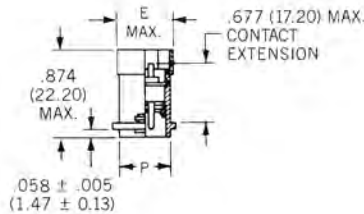
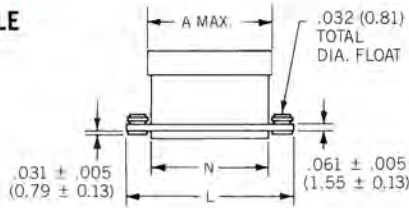

PLUG

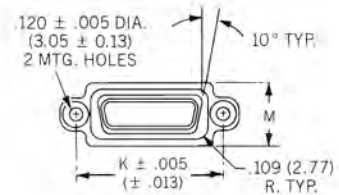
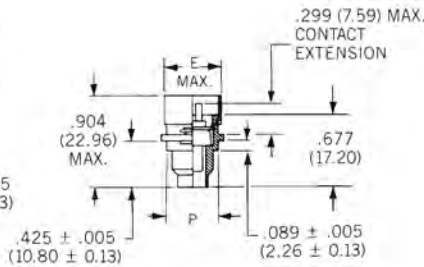
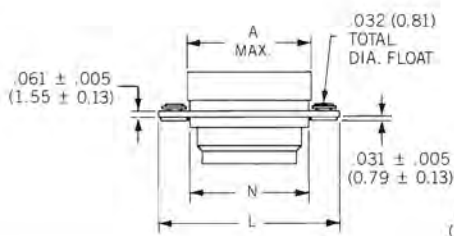

NOTE: All D*D Environmental plugs and receptacles are provided with dust caps and removable potting cups.

Part Number by Shell Size	A	E	K	L	M	N	P
DED-9P	.915(23.24)	.596(15.14)	1.125(28.58)	1.442(36.63)	.614(15.60)	.825(20.86)	.483(12.27)
DED-9S	.915(23.24)	.596(15.14)	1.125(28.58)	1.442(36.63)	.614(15.60)	.825(20.86)	.483(12.27)
DAD-15P	1.233(31.32)	.596(15.14)	1.437(36.50)	1.755(44.58)	.614(15.60)	1.143(29.03)	.483(12.27)
DAD-15S	1.233(31.32)	.596(15.14)	1.437(36.50)	1.755(44.58)	.614(15.60)	1.143(29.03)	.483(12.27)
DBD-25P	1.786(45.36)	.596(15.14)	1.993(50.62)	2.295(58.29)	.614(15.60)	1.683(42.75)	.483(12.27)
DBD-25S	1.786(45.36)	.596(15.14)	1.993(50.62)	2.295(58.29)	.614(15.60)	1.683(42.75)	.483(12.27)
DCD-37P	2.458(62.43)	.567(14.40)	2.625(55.68)	2.937(74.60)	.614(15.60)	2.343(59.51)	.483(12.27)
DCD-37S	2.458(62.43)	.567(14.40)	2.625(55.68)	2.937(74.60)	.614(15.60)	2.343(59.51)	.483(12.27)
DDD-50P	2.390(60.71)	.680(17.27)	2.531(64.29)	2.859(72.62)	.735(18.67)	2.251(57.18)	.596(15.14)
DDD-50S	2.390(60.71)	.680(17.27)	2.531(64.29)	2.859(72.62)	.735(18.67)	2.251(57.18)	.596(15.14)

All tolerances are ± .010(0.24) unless noted otherwise.

CONTACT CRIMPING INFORMATION

CRIMP TYPE CONTACTS

Contact Size	Wire Size Accom.	Standard Finish Pin	Standard Finish Socket	Military Finish Pin	Military Finish Socket
20	20, 22, 24	330-5291-015	031-1007-000	330-5291-079	031-1007-042

INSERTION/EXTRACTION TOOLS



Contact Size	AWG	Plastic Insertion/Extraction		Plastic Extraction	
		Part No.	Description	Part No.	Description
20	20, 22, 24	274-7006-000	CIET-20HD	323-7010-000	CET-20-11



HAND CRIMP TOOLS

Contact Size	AWG	Crimp Tool		Locator	
		Part No.	Description	Part No.	Description
20	20, 22, 24	995-0001-584	M22520/2-01	995-0001-604	M22520/2-08
		995-0001-585	M22520/1-01	995-0001-244	TH25

SEMI-AUTOMATIC CRIMP MACHINES

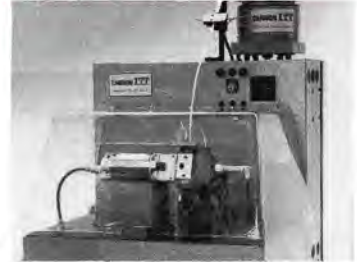

For volume applications the CBT-491 is a vibra-bowl, pneumatically operated crimper offering a more economical approach than belt-fed crimpers. Available for lease or purchase, this machine is designed for use with a wide variety of machined contacts. The MIL-Spec crimp is accomplished at the press of a foot pedal, assuring minimum cycle times and maximum performance.

For lower volumes the CBT-565 is a pneumatically operated bench tool delivering MIL-Spec crimps with minimal operator fatigue.

When you think crimp think Cannon!

ASSEMBLY INSTRUCTIONS

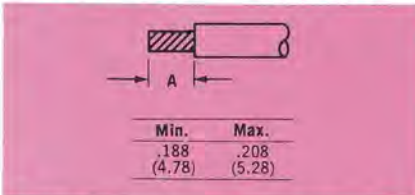

1. Cut wires to length. Strip insulation per above illustration. Check for broken or frayed wires.

CONTACT CRIMPING



2. Insert contact and wire into proper crimp tool (and locator, if required). Crimp contact to wire. Inspect crimp.

CONTACT INSERTION



3. Center wired contact in groove of insertion tool with tool tip butting contact shoulder. Insert contact into cavity until a positive stop is felt. Inspect insertion.



4. To be sure contact is locked securely, pull back lightly on wire. Repeat for balance of contacts, working row by row across the insulator.

CONTACT EXTRACTION



5. Place wire into extraction tool tip. (See above for extraction).



6. Insert tool tip into contact cavity until tip bottoms against contact shoulder, releasing tines. Hold wire against tool with finger and remove tool and contact. Repeat for balance of contacts.

ACCESSORY APPLICATION GUIDE

	D*	D*C/D*U	D*SF	D*P	D*PF	D*M	D*MA	Page No.
JUNCTION SHELLS—METAL	●	●				●	●	56
Round Clamp	●	●				●	●	56
Straight Clamp	●	●				●	●	57
Deep Straight Clamp	●	●				●	●	57
Right Angle	●	●				●	●	57
JUNCTION SHELLS—PLASTIC	●	●				●	●	58
Click	●	●				●	●	58
Universal	●	●				●	●	58
Data Phone	●	●				●	●	58
Ribbon Cable			●					58
J/S with Locking Mechanism	●	●				●	●	59
Plastic Straight	●	●				●	●	59
Plastic Right Angle	●	●				●	●	59
JUNCTION SHELLS—SHIELDED RFI	●	●				●	●	60
Shielded/Shrouded	●	●				●	●	60
Die-Case Straight/90°	●	●				●	●	60
Plated Plastic Straight/45°	●	●				●	●	60
POTTING SHELLS—METAL	●	●				●	●	60
POTTING SHELLS—PLASTIC	●	●				●	●	60
SWITCHING SHELLS	●	●				●	●	60
SLIDE LOCKS	●	●	●	●	●	●	●	61
SCREW LOCKS	●	●	●	●	●	●	●	61
JACKSCREWS	●	●	●			●	●	61
SPRING LATCHES	●	●	●	●	●	●	●	62
GUIDE PIN PLATES	●	●	●			●	●	62
POLARIZING PLATES	●	●	●			●	●	63
GASKETS	●	●	●			●	●	63
DUST CAPS	●	●	●	●	●	●	●	63

● Indicates accessory is compatible with connector series.

NOTE: For D*M and D*MA coax, high power and high voltage applications, consult factory for appropriate Junction Shells.

CONVERSION CHART FOR DIMS. TOL.

Inches	.002	.005	.008	.010	.012	.015	.020	.025	.030	.032
Millimeter	0.05	0.13	0.20	0.25	0.30	0.38	0.51	0.64	0.76	0.81

All tolerances are ± .010(0.3) unless noted otherwise.

JUNCTION SHELLS—METAL

ROUND CLAMP

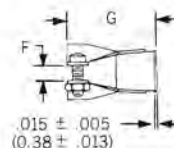
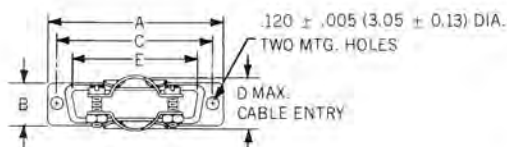

Material: Low carbon steel.

Finish: Cadmium plate, yellow chromate.

Corrosion Resistance: Passes 50-hour exposure to salt spray in accordance with MIL-STD-202A, Method 101A, Condition B.

Part Number by Shell Size

Cannon	Mil. Spec	A ± .015 (0.38)	B ± .015 (0.38)	C ± .005 (0.13)	D MAX.	E ± .015 (0.38)	F ± .015 (0.38)	G ± .030 (0.76)
DE 44994	M85049/48-2-1	1.208(30.7)	.500(12.7)	.984(25.0)	.406(10.3)	.661(16.8)	.125(3.2)	1.031(26.2)
DA 20961	M85049/48-2-2	1.531(38.9)	.500(12.7)	1.312(33.3)	.406(10.3)	.984(25.0)	.125(3.2)	1.031(26.2)
DB 20962	M85049/48-2-3	2.078(52.8)	.500(12.7)	1.852(47.0)	.593(15.1)	1.515(38.5)	.187(4.7)	1.062(27.0)
DC 20963	M85049/48-2-4	2.718(69.0)	.500(12.7)	2.500(63.5)	.718(18.2)	2.171(55.1)	.250(6.3)	1.062(27.0)
DD 20964	M85049/48-2-5	2.625(66.7)	.609(15.5)	2.406(61.1)	.812(20.6)	2.093(53.2)	.312(7.9)	1.062(27.0)

JUNCTION SHELLS— METAL (Continued)

STRAIGHT CLAMP



.120 ± .005 (3.05 ± 0.13) DIA.
TWO MTG. HOLES

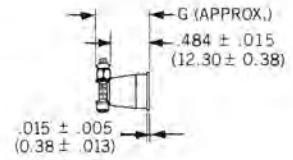
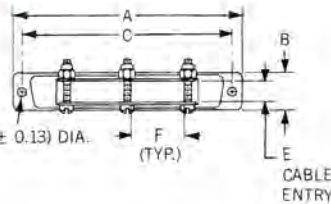

Material: Low carbon steel.
Finish: Cadmium plate, yellow chromate.
Corrosion Resistance: Passes 50-hour exposure to salt spray in accordance with MIL-STD-202A, Method 101A, Condition B.

Part Number by Shell Size

Cannon	Mil. Spec.	No. of Cable Locking Screws Req'd.	A	B	C	E	F	G
DA 1967B-1	M85049/48-3-2	2	1.531(38.9)	.500(12.7)	1.312(33.3)	.296(7.5)	.312(7.9)	.640(16.2)
DB 1967B-2	M85049/48-3-3	2	2.078(52.8)	.500(12.7)	1.852(47.0)	.296(7.5)	.796(20.2)	.640(16.2)
DC 1967B-3	M85049/48-3-4	3	2.718(69.0)	.500(12.7)	2.500(63.5)	.296(7.5)	.687(17.4)	.640(16.2)
DD 1967B-4	M85049/48-3-5	3	2.625(66.7)	.609(12.7)	2.406(61.1)	.390(9.9)	.687(17.4)	.703(17.8)

DEEP STRAIGHT CLAMP



Material: Low carbon steel
Finish: Cadmium plate, yellow chromate.
Corrosion Resistance: Passes 50-hour exposure to salt spray in accordance with MIL-STD-202A, Method 101A, Condition B.

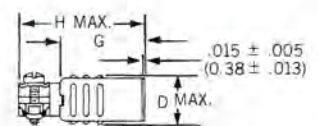
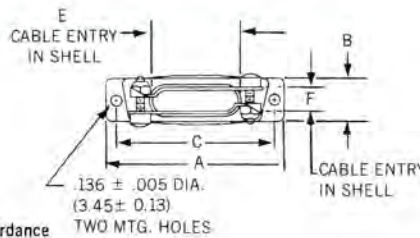

Part Number by Shell Size

Cannon	Mil. Spec.	A	B	C	D	E	F	G	H
DE 24657	M85049/48-1-1	1.203(30.6)	.484(12.3)	.984(25.0)	.578(14.7)	.375(9.5)	.375(9.5)	.750(19.0)	1.250(31.7)
DA 24658	M85049/48-1-2	1.531(38.9)	.484(12.3)	1.312(33.3)	.578(14.7)	.713(18.1)	.312(7.9)	.750(19.0)	1.250(31.7)
DB 24659	M85049/48-1-3	2.078(52.8)	.484(12.3)	1.852(47.0)	.578(14.7)	1.000(25.4)	.312(7.9)	1.000(25.4)	1.563(39.7)
DC 24660	M85049/48-1-4	2.718(69.0)	.484(12.3)	2.500(63.5)	.578(14.7)	1.375(34.9)	.312(7.9)	1.000(25.4)	1.563(39.7)
DD 24661	M85049/48-1-5	2.625(66.7)	.593(15.1)	2.406(61.1)	.687(17.4)	1.406(35.7)	.406(10.3)	1.125(28.6)	1.688(42.9)

RIGHT ANGLE

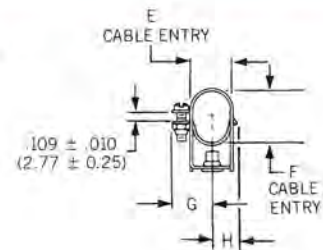
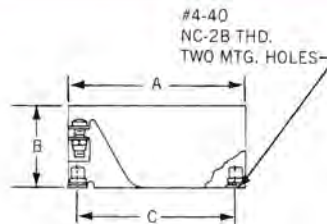

Material: Low carbon steel
Finish: Cadmium plate, yellow chromate.
Corrosion Resistance: Passes 50-hour exposure to salt spray in accordance with MIL-STD-202A, Method 101A, Condition B.

Part Number by Shell Size

Cannon	Mil. Spec.	A	B	C	E	F	G	H
DE 19977-5	M85049/50-1	1.203(30.6)	.718(18.2)	.984(25.0)	.437(11.1)	.437(11.1)	.468(11.9)	.281(7.1)
DA 19977-1	M85049/50-2	1.531(38.9)	.718(18.2)	1.312(33.3)	.437(11.1)	.437(11.1)	.468(11.9)	.281(7.1)
DB 19977-2	M85049/50-3	2.078(52.8)	.968(24.6)	1.852(47.0)	.437(11.1)	.625(15.9)	.468(11.9)	.281(7.1)
DC 19977-3	M85049/50-4	2.718(69.0)	1.187(30.1)	2.500(63.5)	.437(11.1)	.812(20.6)	.468(11.9)	.281(7.1)
DD 19977-4	M85049/50-5	2.625(66.7)	1.250(31.7)	2.406(61.1)	.562(14.3)	.906(23.1)	.531(13.5)	.343(8.7)

**JUNCTION SHELLS—PLASTIC
CLICK**

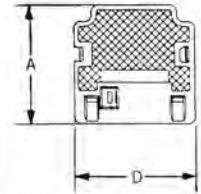
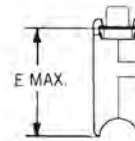
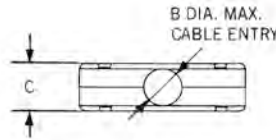

Part Number by Shell Size	A ±.008 (0.20)	B MAX.	C ±.008 (0.20)	D ±.008 (0.20)	E MAX.
DE 115339-20	1.673(42.5)	.276(7.0)	.669(17.0)	.768(19.5)	1.555(39.5)
DA 115339-21	1.673(42.5)	.378(9.6)	.669(17.0)	1.094(27.8)	1.555(39.5)
DB 115339-22	1.673(42.5)	.457(11.6)	.669(17.0)	1.638(41.6)	1.555(39.5)
DC 115339-23	1.673(42.5)	.512(13.0)	.669(17.0)	2.283(58.0)	1.555(39.5)
DD 115339-24	1.673(42.5)	.630(16.0)	.780(19.8)	2.050(52.3)	1.555(39.5)

Material: Flame-retardant thermoplastic.

A 2-piece snap-together design for quick assembly. Customer furnished tie-wrap.

UNIVERSAL

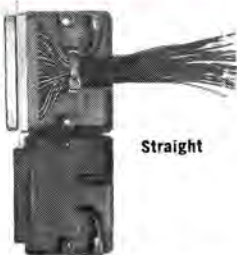

Straight



90°

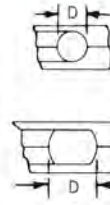
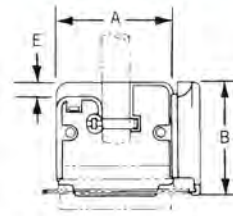
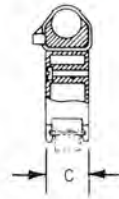

Part Number by Shell Size	A ±.015(±.381)	B ±.020(±.508)	C ±.020(±.508)	D ±.020(±.508)	E ±.010(±.254)
DE 110963-1	.765(19.431)	1.400(35.560)	.600(15.240)	.250(6.350)	.125(3.175)
DA 110963-2	1.097(27.863)	1.569(39.852)	.600(15.240)	.375(9.525)	.161(4.089)
DB 110963-3	1.641(41.681)	1.651(41.935)	.600(15.240)	.410(10.414)	.205(5.207)
DC 110963-4	2.279(57.886)	1.899(48.234)	.600(15.240)	.593(15.062)	.250(6.350)
DD 110963-5	2.063(52.400)	1.925(48.895)	.710(18.034)	.670(17.018)	.285(7.239)

Material: Junction shell — polypropylene; hardware — steel; tie-wrap — nylon.
Finish: Hardware — cadmium plate, yellow chromate.
Color: Black (junction shell).
U.L. rated 94V-2 (flame retardant)

DATA PHONE Available in DB size only.



Part Number:
DB51226-1A

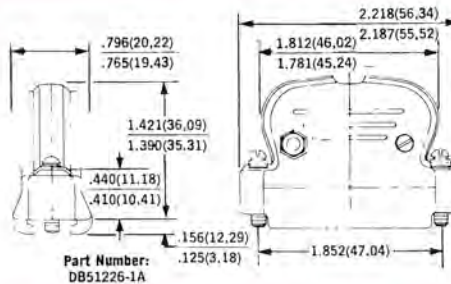

Part Number:
DB51226-1A

Max. Cable Entry
.312 (7.92)

Material: Junction shell — phenolic; hardware — steel.
Finish: Hardware — cadmium plate, clear chromate.
Color: Black (junction shell).
Flame Retardant

Mas/Ter-D® AND SPEEDY-D RIBBON CABLE

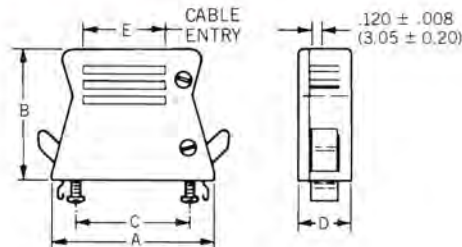

Material: Thermoplastic black 94-V-0; Cadmium plated steel and corrosion resistant steel for optional locking mechanism.

An optional locking mechanism is available. To order use the following part numbers:

- 015-8755-000 Locking hook
- 259-8760-000 Locking spring

Part Number by Shell Size	Inches					Millimeters				
	A ±.011	B ±.011	C ±.005	D ±.011	E ±.007	A ±.03	B ±.03	C ±.013	D ±.03	E ±.02
DE 115386-1B	1.602	1.574	0.984	0.629	0.590	40.7	40	25.0	16	15.0
DA 115386-2B	1.929	1.574	1.311	0.629	0.917	49.0	40	33.3	16	23.3
DB 115386-3B	2.468	1.574	1.850	0.629	1.456	62.7	40	47.0	16	37.0
DC 115386-4B	3.118	1.574	2.490	0.629	2.106	79.2	40	63.5	16	53.5

**JUNCTION SHELLS—PLASTIC (Continued)
WITH LOCKING MECHANISM**

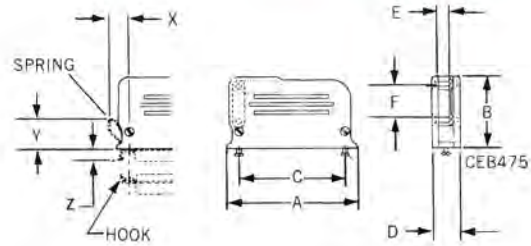

Designation	Part No.	X ±.012 (0.30)	Y ±.012 (0.30)	Z ±.012 (0.30)
Locking spring	259-8760-000	.465(11.80)	.673(17.10)	.260(6.60)

Materials: Thermoplastic black 94-V-0; Cadmium plated steel and/or corrosion resistant steel.

An optional locking mechanism is available. To order use following part numbers.

- 015-8755-000 Locking hook (2 required per connector)
- 259-8760-000 Locking spring (2 per connector)

Part Number by Shell Size	A ±.012 (0.30)	B ±.012 (0.30)	C ±.005 (0.13)	D ±.012 (0.30)	E ±.012 (0.30)	F ±.012 (0.30)
DA 115339-1	1.929(49.00)	1.260(32.00)	1.311(33.30)	.630(16.00)	.315(8.00)	.275(7.00)
DB 115339-2	2.480(63.00)	1.653(42.00)	1.852(47.04)	.630(16.00)	.315(8.00)	.708(18.00)
DC 115339-3	3.118(79.20)	1.653(42.00)	2.500(63.50)	.630(16.00)	.315(8.00)	.708(18.00)
DD 115339-4	3.023(76.80)	1.653(42.00)	2.405(61.10)	.748(19.00)	.433(11.00)	.708(18.00)
DE 115339	1.614(41.0)	1.260(32.0)	0.984(25.0)	.630(16.0)	.315(8.0)	.275(7.0)

STRAIGHT

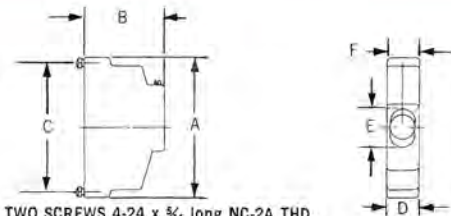

TWO SCREWS 4-24 x 5/16 long NC-2A THD. SELF-TAPPING

Part Number by Shell Size

Black	Grey	A ±.015 (0.38)	B ±.015 (0.38)	C ±.005 (0.13)	D ±.015 (0.38)	E ±.010 (0.25)	F ±.010 (0.25)
DE 51218	DE 51218-9	1.218(30.9)	1.000(25.4)	.984(25.0)	.500(12.7)	.281(7.1)	.281(7.1)
DA 51210	DA 51210-9	1.546(39.3)	1.000(25.4)	1.312(33.3)	.500(12.7)	.360(9.1)	.360(9.1)
DB 51212	DB 51212-9	2.093(53.2)	1.250(31.7)	1.852(47.0)	.500(12.1)	.493(12.5)	.360(9.1)
DC 51214	DC 51214-9	2.734(69.4)	1.500(38.1)	2.500(63.5)	.500(12.7)	.694(17.6)	.360(9.1)
DD 51216	DD 51216-9	2.640(67.1)	1.500(38.1)	2.406(61.1)	.609(15.5)	.734(18.6)	.468(11.9)

Material: Thermoplastic—Flame retardant 94-V-2
Color: Black or Grey

Corrosion Resistance: Hardware passes 50-hour exposure to salt spray in accordance with MIL-STD-202A, Method 101A, Condition B.

RIGHT ANGLE

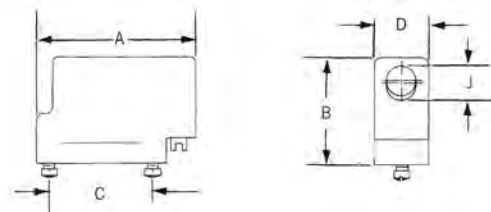

Part Number by Shell Size

Black	Grey	A ±.015 (0.38)	B ±.015 (0.38)	C ±.005 (0.13)	D ±.015 (0.38)	J ±.010 (0.25)
DA 51211	DA 51211-9	1.822(46.3)	1.000(25.4)	1.312(33.3)	.500(12.7)	.360(9.1)
DB 51213	DA 51213-9	2.368(60.1)	1.250(31.7)	1.852(47.0)	.500(12.7)	.493(12.5)
DC 51215	DC 51215-9	3.009(76.4)	1.500(38.1)	2.500(63.5)	.500(12.7)	.694(17.6)
DD 51217	DD 51217-9	2.915(74.0)	1.500(38.1)	2.406(61.1)	.609(15.5)	.734(18.6)

Material: Thermoplastic—Flame retardant 94-V-2
Color: Black or Grey

Corrosion Resistance: Hardware passes 50-hour exposure to salt spray in accordance with MIL-STD-202A, Method 101A, Condition B.

JUNCTION SHELLS—SHIELDED RFI

(Refer to "Shielded-D" ordering info, page 31)

DIECAST STRAIGHT/90°



Ordering info see page 28.

SHIELDED/SHROUDED



Ordering info see page 25.

PLATED PLASTIC



Ordering info see page 28.

POTTING SHELLS—METAL

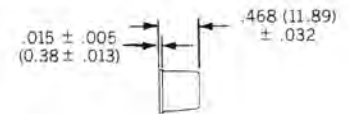
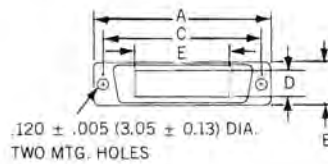

Part Number by Shell Size

Cannon	± .015 (0.38)	± .015 (0.38)	± .010 (0.25)	D	± .020 (0.51)
DA 19678-10	1.531(38.887)	.500(12.700)	1.312(33.324)	.300(7.620)	.588(14.935)
DB 19678-11	2.078(52.781)	.500(12.700)	1.852(47.040)	.300(7.620)	1.125(28.575)
DC 19678-12	2.718(69.037)	.500(12.700)	2.500(63.500)	.300(7.620)	1.750(44.450)
DD 19678-13	2.625(66.675)	.609(15.468)	2.406(61.112)	.390(9.906)	1.750(44.450)

Material: Low carbon steel

Finish: Cadmium plate, yellow chromate.

Corrosion Resistance: Passes 50-hour exposure to salt spray in accordance with MIL-STD-202A, Method 101A, Condition B.

POTTING SHELLS—PLASTIC

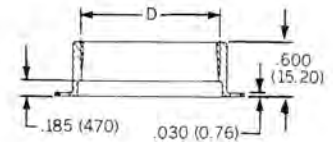
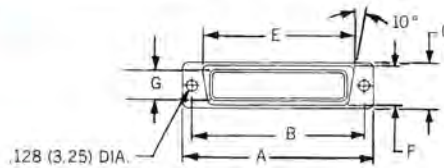

Part Number by Shell Size

Cannon	± .015 (0.38)	B	± .010 (0.25)	± .015 (0.38)	± .020 (0.51)	± .010 (0.25)	± .020 (0.51)
DE 50904-1	1.208(30.683)	.984(24.993)	.495(12.573)	.641(16.281)	.769(19.532)	.430(10.992)	.345(8.763)
DA 50905-1	1.536(39.014)	1.312(33.324)	.495(12.573)	.973(24.714)	1.104(28.041)	.430(10.992)	.345(8.763)
DB 50906-1	2.083(52.908)	1.852(47.040)	.495(12.573)	1.516(38.506)	1.639(41.630)	.430(10.992)	.345(8.763)
DC 50907-1	2.723(69.164)	2.500(63.500)	.495(12.573)	2.154(54.711)	2.289(58.140)	.430(10.992)	.345(8.763)
DD 50908-1	2.630(66.802)	2.406(61.112)	.606(15.392)	1.938(49.225)	2.189(55.600)	.545(13.843)	.445(11.303)

Material: Nylon

Color: Natural (white)

Note: Nylon potting shells are molded with a thin flange .030(0.76) to permit the use of D Subminiature locking devices.

SWITCHING SHELLS

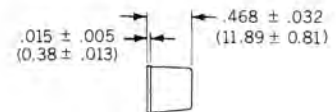
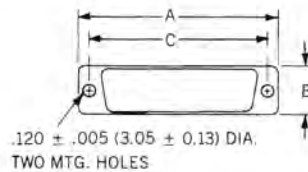

Part Number by Shell Size

Cannon	± .015 (0.38)	± .015 (0.38)	± .005 (0.13)
DA 19678-6	1.531(38.887)	.500(12.700)	1.312(33.324)
DB 19678-7	2.078(52.781)	.500(12.700)	1.852(47.040)
DC 19678-8	2.718(69.037)	.500(12.700)	2.500(63.500)
DD 19678-9	2.625(66.675)	.609(15.468)	2.406(61.112)

Material: Low carbon steel.

Finish: Cadmium plate, yellow chromate.

Corrosion Resistance: Passes 48-hour exposure to salt spray in accordance with MIL-STD-202A, Method 101A, Condition B.

SLIDE LOCKS

SLIDING LOCK RETAINER

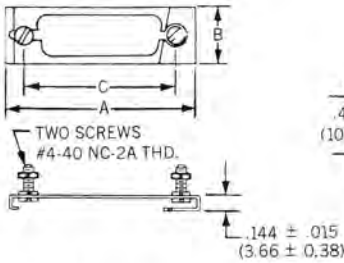

Material: Retainer plate — stainless steel; hardware — cold rolled steel.

Finish: Retainer plate — passivated; hardware — Cadmium plate, yellow chromate.

Corrosion Resistance: Passes 48-hour exposure to salt spray in accordance with MIL-STD-202A, Method 101A, Condition B.

SLIDING LOCK POST—ORDER TWO PER CONNECTOR

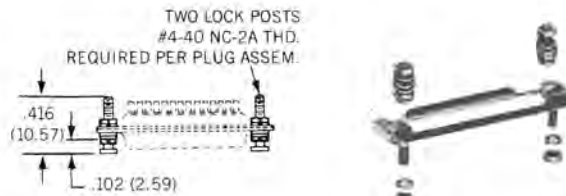

SLIDING LOCK POST

	Part Number
Steel	D53018
Non-Magnetic	D53018-5

LOCKED POSITION

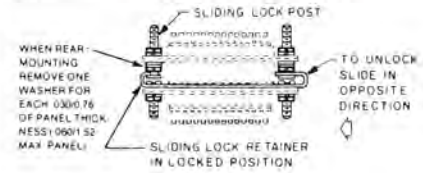

SLIDING LOCK RETAINER Part Number by Shell Size

	A	B	C
Cannon	±.015 (0.38)	±.015 (0.38)	±.005 (0.13)
DE 51224-1	1.392(35.36)	.500(12.70)	.984(25.00)
DA 51220-1	1.720(43.70)	.500(12.70)	1.312(33.32)
DB 51221-1	2.260(57.40)	.500(12.70)	1.852(47.07)
DC 51222-1	2.908(73.86)	.500(12.70)	2.500(63.50)
DD 51223-1	2.814(71.47)	.609(15.47)	2.406(61.10)

SCREW LOCKS

FEMALE

NOTE: Order two per connector

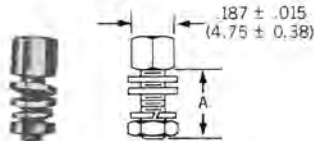

Material: Cold rolled steel

Finish: Cadmium plate, yellow chromate.

Corrosion Resistance: Passes 48-hour exposure to salt spray in accordance with MIL-STD-202A, Method 101A, Condition B.

NOTE: A 6 inch/pound (female) and 4 inch/pound (male) maximum torque during assembly is recommended on steel screw lock assemblies.

MOUNTED POSITION

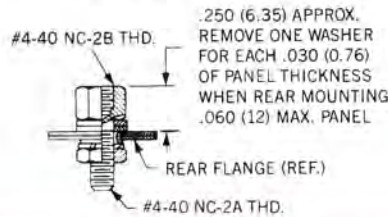

Part Number

	A	
Cannon	Mil. Spec.	±.015 (0.38)
D20418-2	M24308/26-1	.312(7.92)
D20418-50	—	.500(12.70)
D20418-39	M24308/26-2	.625(15.88)
D20418-74	—	.750(19.05)

MALE

NOTE: Order two per connector

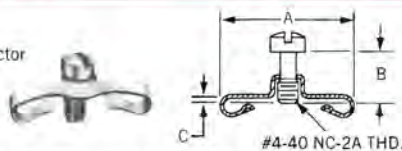

Material: Clip—sheet steel; hardware—cold rolled steel.

Finish: Cadmium plate, yellow chromate.

Corrosion Resistance: Passes 48-hour exposure to salt spray in accordance with MIL-STD-202A, Method 101A, Condition B.

Part Number

Cannon	Mil. Spec.	A	B	C	Connector Size
		±.015 (±0.38)	±.015 (±0.38)	±.005 (±0.13)	
D20419	—	.555(14.10)	.250(6.35)	.048(1.22)	DE, DA, DB, DC
D20419-18	M24308/25-9	.555(14.10)	.281(7.14)	.067(1.70)	DE, DA, DB, DC
D20419-21	—	.555(14.10)	.281(7.14)	.092(2.34)	DE, DA, DB, DC
D20419-104	—	.555(14.10)	.312(7.92)	.092(2.34)	DE, DA, DB, DC
D20420	—	.656(16.66)	.250(6.35)	.048(1.22)	DD only
D20420-13	M24308/25-10	.656(16.66)	.281(7.14)	.067(1.70)	DD only
D20420-15	—	.656(16.66)	.281(7.14)	.092(2.34)	DD only
D20420-86	—	.656(16.66)	.312(7.92)	.092(2.34)	DD only

JACKSCREW ORDER ONE PER CONNECTOR (not recommended for use with metal junction shells or for rear panel mounting)

JACKSCREW



JACKPOST

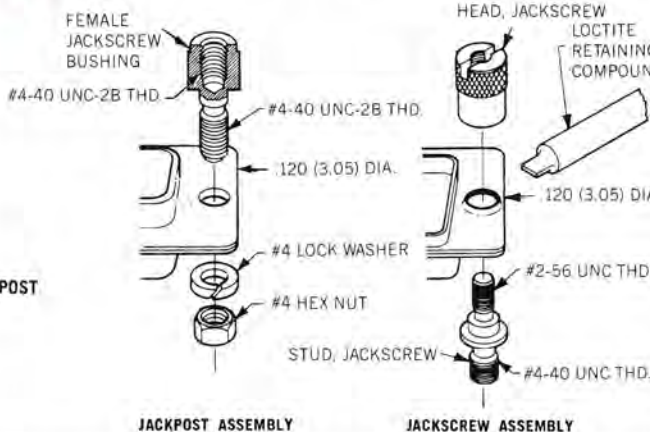

	Part Number	Material	Finish
Jackcrew	D110550*	Stainless steel	None
Jackpost	D110551*	Stainless steel	Passivate

*Part number consists of two assemblies each as required per connector. Fits all standard D Series with .120 (3.05) diameter mounting holes. 5 1/2 inch/pounds maximum torque during assembly is recommended.

SPRING LATCHES

ORDER TWO PER CONNECTOR

Material: Stainless steel.
Finish: Passivated.

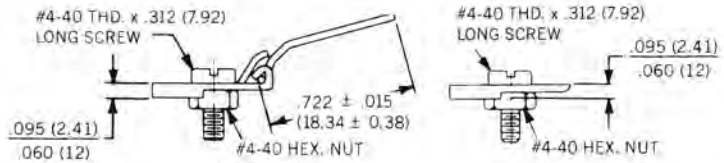

END DISC LATCH ASSEMBLY

End Disc Latch Assembly Part Number	A ± .015 (0.38)	B ± .015 (0.38)
D110278 (Sizes DE, DA, DB, DC)	.484(12.3)	.556(14.1)
D110280 (Size DD)	.609(15.5)	.673(17.1)
Spring Latch Assembly Part Number	A ± .015 (0.38)	B ± .015 (0.38)
D110277 (Sizes DE, DA, DB, DC)	.484(12.3)	.556(14.1)
D110279 (Size DD)	.609(15.5)	.673(17.1)

NOTE: Two end disk latch assemblies and two spring latch assemblies are required per mated connector.

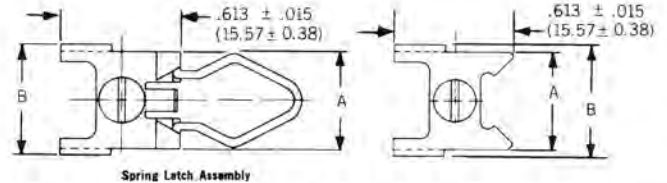

GUIDE PIN PLATES

MALE

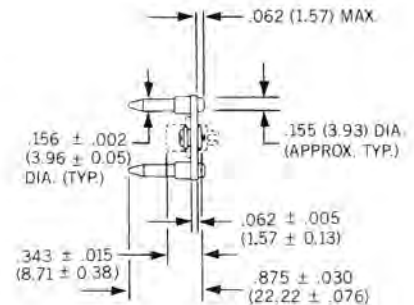
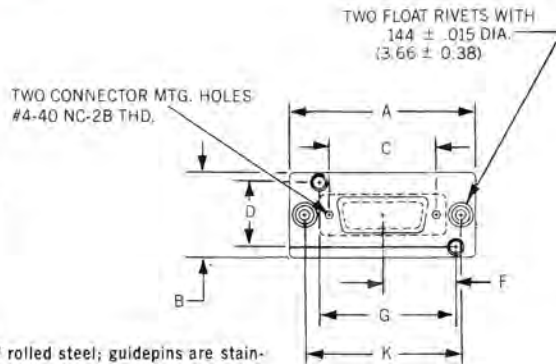

Material: Plates and float hardware are cold rolled steel; guidepins are stainless steel.

Plate Finish: Cadmium plate, yellow chromate.

Corrosion Resistance: Passes 48-hour exposure to salt spray in accordance with MIL-STD-202A, Method 101A, Condition B.

.032 (0.81) TOTAL DIAMETRICAL FLOAT

Part Number by Shell Size

Cannon	A ± .015 (0.38)	B ± .015 (0.38)	C ± .005 (0.13)	D .750 (19.050)	F ± .005 (0.13)	G 1.663 (42.240)	K ± .005 (0.13)
DA 22213	2.281(57.937)	1.000(25.400)	1.312(33.324)	.750(19.050)	.898(22.809)	1.663(42.240)	1.906(48.412)
DB 22255	2.820(71.628)	1.000(25.400)	1.852(47.040)	.750(19.050)	1.168(29.667)	2.203(55.956)	2.446(62.128)
DC 22070	3.468(88.087)	1.000(25.400)	2.500(63.500)	.750(19.050)	1.492(37.896)	2.851(72.415)	3.094(78.587)
DD 21962	3.375(85.725)	1.125(28.575)	2.406(61.112)	.874(22.1996)	1.437(36.499)	2.749(69.824)	3.000(76.200)

FEMALE

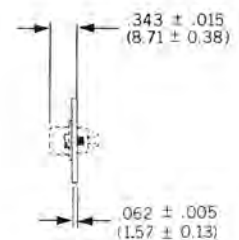
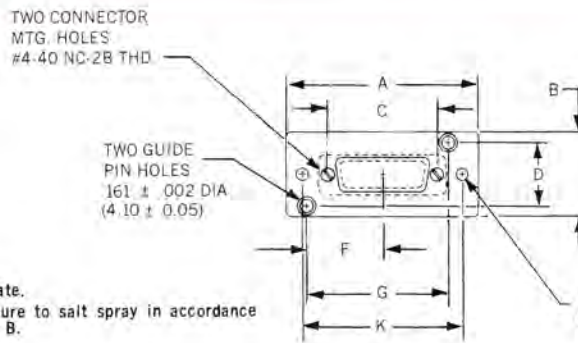

Material: Cold rolled steel.

Plate Finish: Cadmium plate, yellow chromate.

Corrosion Resistance: Passes 48-hour exposure to salt spray in accordance with MIL-STD-202A, Method 101A, Condition B.

Part Number by Shell Size

Cannon	A ± .015 (0.38)	B ± .015 (0.38)	C ± .005 (0.13)	D .750 (19.050)	F ± .005 (0.13)	G 1.663 (42.240)	K ± .005 (0.13)
DA 22214	2.281(57.937)	1.000(25.400)	1.312(33.324)	.750(19.050)	.898(22.809)	1.663(42.240)	1.906(48.412)
DB 22254	2.820(71.628)	1.000(25.400)	1.852(47.040)	.750(19.050)	1.168(29.667)	2.203(55.956)	2.446(62.128)
DC 22071	3.468(88.087)	1.000(25.400)	2.500(63.500)	.750(19.050)	1.492(37.896)	2.851(72.415)	3.094(78.587)
DD 21961	3.375(85.725)	1.125(28.575)	2.406(61.112)	.874(22.1996)	1.437(36.499)	2.749(69.824)	3.000(76.200)

POLARIZING PLATES

Material: Black plastic, 94-V-0 rated

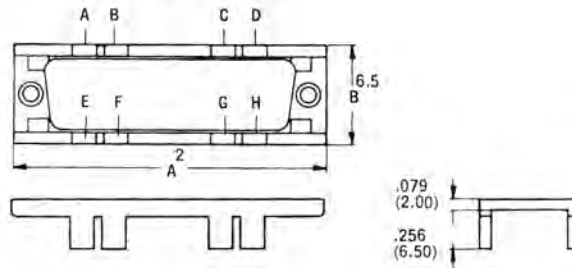

Polarizing scheme

Polarizing Keys		A	B	C	D	E	F	G	H
Position	1	○	⊗	⊗	○	○	⊗	⊗	○
	2	⊗	○	○	⊗	⊗	○	○	⊗
	3	○	⊗	○	○	○	○	○	○
	4	⊗	⊗	⊗	⊗	⊗	⊗	⊗	⊗
	5	○	○	○	○	○	○	○	○
	6	○	○	○	○	○	○	○	○
	7	○	○	○	○	○	○	○	○
	8	○	○	○	○	○	○	○	○
	9	○	○	○	○	○	○	○	○
	10	○	○	○	○	○	○	○	○

○ Cut Key on pin connector
⊗ Cut key on socket connector

Part Number by Shell Size	A	B
DE 115398	1.208(30.7)	0.629(16)
DA 115398-1	1.535(39.0)	0.629(16)
DB 115398-2	2.082(52.9)	0.629(16)
DC 115398-3	2.726(69.2)	0.629(16)
DD 115398-4	2.630(66.8)	0.749(19)

DUST CAPS

Material: Polyethylene (red).

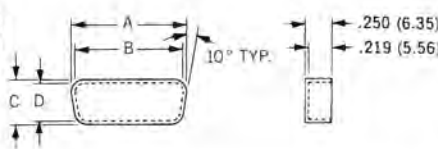

Part Number by Shell Size	Use with	A	B	C	D
DE 59-20	DE 9S	.694(17.6)	.627(15.9)	.362(9.2)	.295(7.5)
DE 60-20	DE 9P	.749(19.0)	.682(17.3)	.412(10.5)	.345(8.8)
DA 59-20	DA 15S	1.022(26.0)	.955(24.3)	.362(9.2)	.295(7.5)
DA 60-20	DA 15P	1.077(27.4)	1.010(25.7)	.412(10.5)	.345(8.8)
DB 59-20	DB 25S	1.562(39.7)	1.495(38.0)	.362(9.2)	.295(7.5)
DB 60-20	DB 25P	1.635(41.5)	1.568(39.8)	.430(10.9)	.363(9.2)
DC 59-20	DC 37S	2.210(56.1)	2.143(54.4)	.362(9.2)	.295(7.5)
DC 60-20	DC 37P	2.283(57.9)	2.216(56.3)	.430(10.9)	.363(9.2)
DD 59-20	DD 50S	2.116(53.7)	2.049(52.0)	.474(12.0)	.407(10.3)
DD 60-20	DD 50P	2.179(55.3)	2.112(53.6)	.536(13.6)	.469(11.9)

RIGHT ANGLE BRACKETS (Used with 90° Printed Circuit Connector D*M, D*, D*C/D*U)

NOTE: For applicable contact extension see pages 5 and 13.



Material: Nylon 6/6 heat stabilized 30% glass fiber, UL-SE-0. Color: Black.

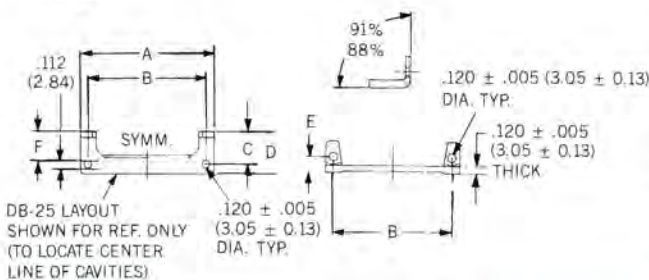

DB-25 LAYOUT SHOWN FOR REF. ONLY (TO LOCATE CENTER LINE OF CAVITIES)

D*/D*M

Shell Size	Part Number	A ±.015	B ±.005	C ±.005	D ±.010	E ±.010	F ±.010
DE	015-0338-000	1.224(31.1)	.984(24.0)	.340(8.63)	.484(12.3)	.247(6.27)	.283(7.2)
DA	015-0339-000	1.552(39.4)	1.312(33.3)	.340(8.63)	.484(12.3)	.247(6.27)	.283(7.2)
DB	015-0340-000	2.092(53.1)	1.852(47.0)	.340(8.63)	.484(12.3)	.247(6.27)	.283(7.2)
DC	015-0341-000	2.740(69.0)	2.500(63.5)	.340(8.63)	.484(12.3)	.247(6.27)	.283(7.2)
DD	015-0342-000	2.646(67.2)	2.406(61.1)	.395(10.0)	.594(15.1)	.302(7.67)	.283(7.2)

D*C/D*U

Shell Size	Part Number	A ±.015	B ±.005	C ±.005	D ±.010	E ±.010	F ±.010
DE	015-0348-000	1.224(31.1)	.984(24.0)	.502(12.8)	.647(16.4)	.247(6.27)	.445(11.3)
DA	015-0349-000	1.552(39.4)	1.312(33.3)	.502(12.8)	.647(16.4)	.247(6.27)	.445(11.3)
DB	015-0350-000	2.092(53.1)	1.852(47.0)	.502(12.8)	.647(16.4)	.247(6.27)	.445(11.3)
DC	015-0351-000	2.740(69.0)	2.500(63.5)	.502(12.8)	.647(16.4)	.247(6.27)	.445(11.3)
DD	015-0352-000	2.646(67.2)	2.406(61.1)	.558(14.2)	.756(19.2)	.302(7.67)	.445(11.3)

GASKETS



Material: Silastic sheet

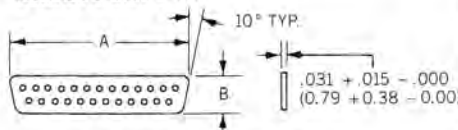

Part Number by Shell Size	A	B
DE 53750	.656(16.7)	.328(8.3)
DA 53750-1	.984(25.0)	.328(8.3)
DB 53750-2	1.531(38.9)	.328(8.3)
DC 53750-3	2.171(55.1)	.328(8.3)
DD 53750-4	2.078(52.8)	.437(11.1)

WIRE HOLE FILLERS (D*MA Series Only)

(D*MA Series Only)

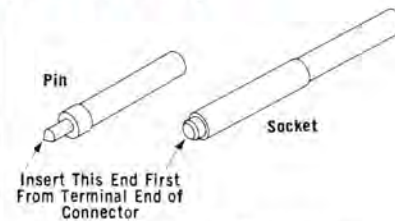

Material: Nylon.

Part Number	Insert Type
DMA 51236-1	Socket
DMA 51235-1	Pin

ALIGNMENT TOOL

(For D*C/D*U BURGUN-D 90° Connectors with Machined Contacts Only)



Part Number: 317-1389-000

PC BOARD HOLE PATTERNS

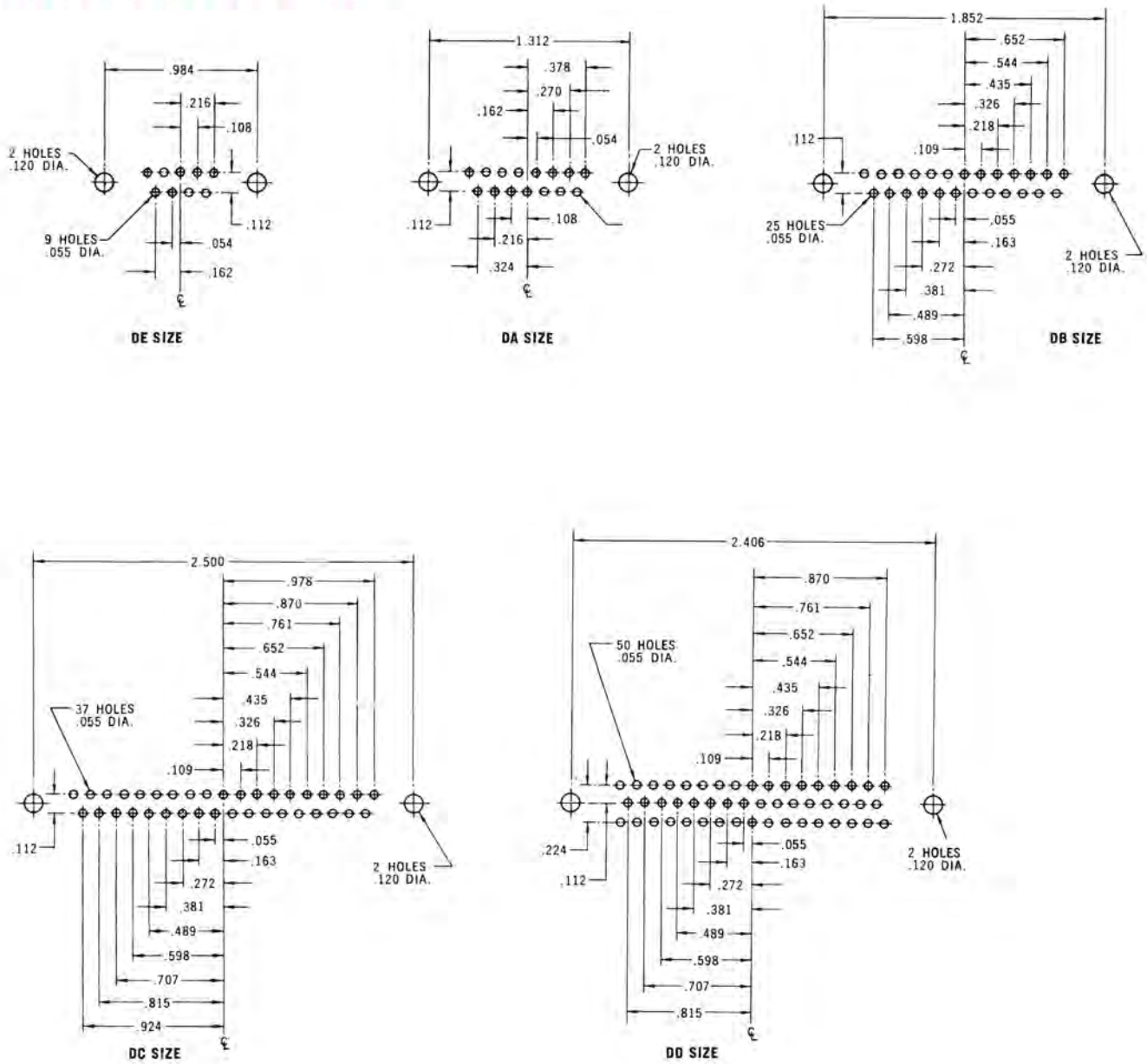

Conversion Chart—Inches to Millimeters

Inches	mm	Inches	mm	Inches	mm	Inches	mm
.054	1.37	.216	5.49	.381	9.68	.816	20.73
.055	1.40	.218	5.54	.435	11.05	.870	22.10
.108	2.74	.224	5.69	.489	12.42	.924	23.47
.109	2.77	.270	6.86	.544	13.82	.978	24.84
.112	2.84	.272	6.91	.598	15.19	.984	24.99
.120	3.05	.324	8.23	.652	16.56	1.312	33.32
.162	4.11	.326	8.28	.707	17.96	1.852	47.04
.163	4.14	.378	9.60	.761	19.33	2.406	61.11
						2.500	63.50

Dia. P/C Tail	Recommended P/C Board Hole Dia.
.028(0.71)	.045(1.14)
.030(0.76)	.045(1.14)
.040(1.02)	.055(1.40)

PANEL CUTOUTS

D*, D*C, D*U, D*M, D*MA, D*SP

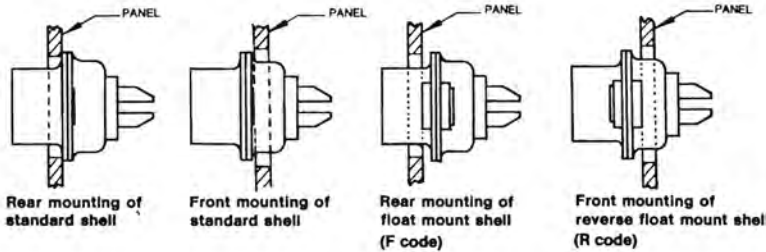

STANDARD CUTOUT

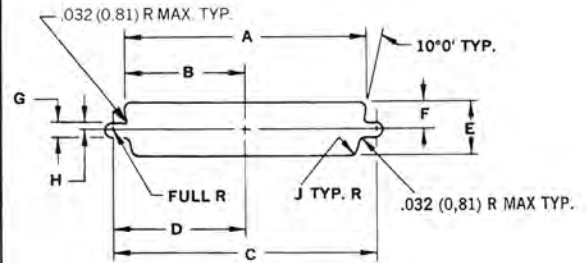

**OPTIONAL CUTOUT
(For Rear Mounting)**

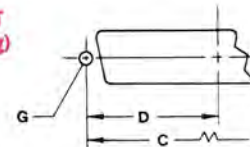

Connector Size	Mounting Method	A ±.005(0.13)	B ±.005(0.13)	C ±.005(0.13)	D ±.005(0.13)	E ±.005(0.13)	F ±.005(0.13)	G ±.002(0.05)	H ±.002(0.05)	J ±.002(0.05)
A Standard	Front Mounting	1.202(30.53)	.601(15.26)	1.312(33.32)	.656(16.66)	.513(13.03)	.257(6.52)	.120(3.04)	.060(1.52)	.083(2.10)
	Rear Mounting	1.134(28.80)	.567(14.40)	1.312(33.32)	.656(16.66)	.449(11.40)	.225(5.71)	.120(3.04)	.060(1.52)	.132(3.35)
A Float	Front Mounting	1.234(31.34)	.617(15.67)	1.312(33.32)	.656(16.66)	.545(13.84)	.273(6.93)	.088(2.23)	.044(1.11)	.083(2.10)
	Rear Mounting	1.166(29.61)	.583(14.80)	1.312(33.32)	.656(16.66)	.481(12.21)	.241(6.12)	.088(2.23)	.044(1.11)	.132(3.35)
B Standard	Front Mounting	1.743(44.27)	.872(22.14)	1.852(47.04)	.926(23.52)	.513(13.03)	.257(6.52)	.120(3.04)	.060(1.52)	.083(2.10)
	Rear Mounting	1.674(42.51)	.837(21.25)	1.852(47.04)	.926(23.52)	.449(11.40)	.225(5.71)	.120(3.04)	.060(1.52)	.132(3.35)
B Float	Front Mounting	1.775(45.08)	.888(22.55)	1.852(47.04)	.926(23.52)	.545(13.84)	.273(6.93)	.088(2.23)	.044(1.11)	.083(2.10)
	Rear Mounting	1.706(43.33)	.853(21.66)	1.852(47.04)	.926(23.52)	.481(12.21)	.241(6.12)	.088(2.23)	.044(1.11)	.132(3.35)
C Standard	Front Mounting	2.391(60.73)	1.196(30.37)	2.500(63.50)	1.250(31.75)	.513(13.03)	.257(6.52)	.120(3.04)	.060(1.52)	.083(2.10)
	Rear Mounting	2.326(59.08)	1.163(29.54)	2.500(63.50)	1.250(31.75)	.449(11.40)	.225(5.71)	.120(3.04)	.060(1.52)	.132(3.35)
C Float	Front Mounting	2.423(61.54)	1.212(30.78)	2.500(63.50)	1.250(31.75)	.545(13.84)	.273(6.93)	.088(2.23)	.044(1.11)	.083(2.10)
	Rear Mounting	2.354(59.79)	1.177(29.89)	2.500(63.50)	1.250(31.75)	.481(12.21)	.241(6.12)	.088(2.23)	.044(1.11)	.132(3.35)
D Standard	Front Mounting	2.297(58.34)	1.149(29.18)	2.406(61.11)	1.203(30.55)	.623(15.82)	.312(7.92)	.120(3.04)	.060(1.52)	.083(2.10)
	Rear Mounting	2.218(56.33)	1.109(28.16)	2.406(61.11)	1.203(30.55)	.555(14.09)	.278(7.06)	.120(3.04)	.060(1.52)	.132(3.35)
D Float	Front Mounting	2.329(59.15)	1.165(29.59)	2.406(61.11)	1.203(30.55)	.655(16.63)	.328(8.33)	.088(2.23)	.044(1.11)	.083(2.10)
	Rear Mounting	2.250(57.15)	1.125(28.57)	2.406(61.11)	1.203(30.55)	.587(14.90)	.294(7.46)	.088(2.23)	.044(1.11)	.132(3.35)
E Standard	Front Mounting	.874(22.19)	.437(11.09)	.984(24.99)	.492(12.49)	.513(13.03)	.257(6.52)	.120(3.04)	.060(1.52)	.083(2.10)
	Rear Mounting	.806(20.47)	.403(10.23)	.984(24.99)	.492(12.49)	.449(11.40)	.225(5.71)	.120(3.04)	.060(1.52)	.132(3.35)
E Float	Front Mounting	.906(23.01)	.453(11.50)	.984(24.99)	.492(12.49)	.545(13.84)	.273(6.93)	.088(2.23)	.044(1.11)	.083(2.10)
	Rear Mounting	.838(21.28)	.419(10.64)	.984(24.99)	.492(12.49)	.481(12.21)	.241(6.12)	.088(2.23)	.044(1.11)	.132(3.35)

PANEL MOUNTING

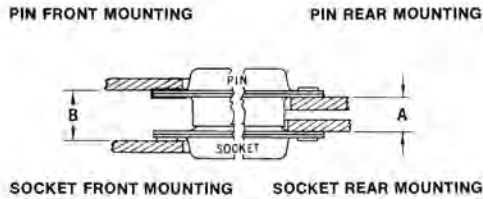

FIGURE 1A

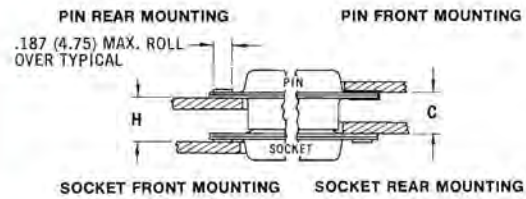

FIGURE 1B

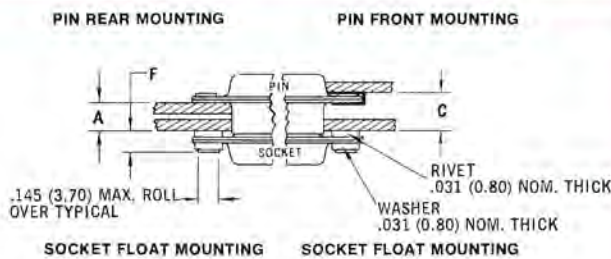

FIGURE 2

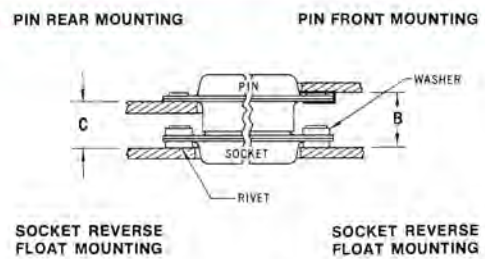

FIGURE 3

Fig. No.	Combination of Mated Connectors			A	B	C	F	H
	Size	Pin (See Note below)	Socket	+ .030(+0.76) - .000(-0)	+ .030(+0.76) - .000(-0)	+ .030(+0.76) - .000(-0)	± .010(±0.25)	+ .030(+0.76) - .000(-0)
1	A, E	Standard	Standard	.250(6.35)	.340(8.63)	.295(7.49)	—	.295(7.49)
1	B, C, D	Standard	Standard	.238(6.04)	.343(8.71)	.298(7.56)	—	.283(7.18)
2	A, E	Standard	Float Mount	.218(5.53)	—	.263(6.68)	.120(3.04)	—
2	B, C, D	Standard	Float Mount	.206(5.23)	—	.266(6.75)	.120(3.04)	—
2	A, E	Float Mount	Standard	.218(5.53)	—	.263(6.68)	.120(3.04)	—
2	B, C, D	Float Mount	Standard	.206(5.23)	—	.251(6.37)	.130(3.30)	—
3	A, E	Standard	Rev. Float Mount	—	.358(9.09)	.313(7.95)	.120(3.04)	—
3	B, C, D	Standard	Rev. Float Mount	—	.361(9.16)	.301(7.64)	.120(3.04)	—
3	A, E	Rev. Float Mount	Standard	—	.358(9.09)	.313(7.95)	.120(3.04)	—
3	B, C, D	Rev. Float Mount	Standard	—	.355(9.01)	.310(7.87)	.130(3.30)	—

NOTE:

1. A, B, C, and H are dimensions between panels and represent the recommended limit to be used in the design of the connector mounting method.
2. It is recommended that only one assembly, either pin or socket, be float mounted.
3. Standard pin assemblies contained .015 (0.38) thick front shells on E and A sizes; .024 (0.61) thick front shells on B, C, and D sizes.
4. Standard connectors accommodate a #4 screw. Float mount connectors accommodate a #2 screw.

MODIFICATION CODES

CODE	DESCRIPTION	APPLICATION
A101	Cadmium Plate, Yellow Chromate per QQ-P-416	Standard on most connector shells and accessories
A106	Gold over Copper Plating per MIL-G-45204 Type II Class 2 (100 Microinches)	D*M, D*MA, GD*, D*D
A156	Gold over Copper Plating per MIL-G-45204 Type II Class I (50 Microinches)	D*M, D*MA, GD*, D*D
A159	Electroless Nickel per MIL-C-26074 B	D*M, D*MA, GD*
A183	Zinc Plate, Yellow Chromate per ASTM-B-633	D*, D*C, D*U. Standard for D*SF
A197	Tin/Lead Electroplated Shells	D*, D*M, D*MA, D*C, D*U
A201	Gold over Nickel Plating	Standard contact finish All D Subminiature
A203	Zinc Plate, Clear Chromate per ASTM-B-633	D*, D*C, D*U
A208	Gold over Nickel (30 Microinches)	D*C, D*U, D*P
C37	Diallyl Phthalate Insulators per MIL-M-14, Color Green	D*. Standard for D*M, D*MA
C53	Black 94V-0 Insulators Polyamide	D*
FO	Less Contacts	D*MA, D*C, D*U, GD*, D*D
F179	Wrap Post Contacts, .375 (9.52)	D*, D*M
F179A	Wrap Post Contacts, .500 (12.7) Extension	D*, D*M
F197	Ground Spring Installed in Socket Connector	D*U
F201	Pin Shell with Multiple Grounding Indentations	D*, D*M, D*MA, D*C, D*U, GD*
F202	Metal Right Angle Bracket	D*U

CODE	DESCRIPTION	APPLICATION
K47	Connector Shell Plated Gold Over Copper (A156)	D*MA, GD*, Applicable to Connectors Less Contacts (FO)
K52	Connector Shell and Contacts Plated Gold over Copper (A156)	D*M, D*MA, GD*
K56	Connector Shell Plated with (A156) Finish, Contacts Plated with (A106) Finish	D*M, D*MA, GD*
K87	Shell Plated A197, with F201 Grounding Indentations (Pin Connector)	D*, D*M, D*MA, D*C, D*U
K97	Shell Plated A197 with F202 Right Angle Metal Brackets	D*U
K98	Shell Plated A197 F201 Multiple Grounding Indentations F202 Right Angle Metal Brackets	D*U
K101	A197 Shells A208 Contacts	D*, D*U
K102	A208 Contacts K87 Shells	D*, D*U
NM	Connector Supplied with Brass Shells, Screened for 2000 Gamma Residual Magnetism	D*, D*M, D*MA
NMB	Connector Supplied with Brass Shells and Unpigmented Insulators, Screened for 200 Gamma Residual Magnetism	D*M, D*MA
NMC	Connectors Supplied with Brass Shells and Unpigmented Insulators. Screened for 20 Gamma Residual Magnetism	D*M, D*MA
WS	Neoprene Wire Separator Bonded to Rear of Insulator	D*MA

TEST DATA
MIL-C-24308 TEST EXTRACTS APPLICABLE TO CLASS G CONNECTORS

Test Description	Requirement			Method
	Shell Size	Max Unmating (LBS)	Max Mating (LBS)	
Mating/Unmating Force	1	6	10	MIL-STD-1344 Method 2013
	2	10	17	
	3	17	28	
	4	24	39	
	5	30	49	
Contact Retention	Contacts shall be retained in their inserts by a 9 pound (minimum) force. The axial displacement of contacts shall not exceed .012 inch while under load			MIL-STD-1344 Method 2004
Insulation Resistance	After humidity 1 Megohm (min) All other conditions 5000 Megohm (min).			MIL-STD-1344 Method 3003
Contact Resistance	After salt spray not to exceed 55 millivolts max.			#20 AWG; 7.5 Amp MIL-STD-1344 Method 3004
Vibration	No damage and no loosening of parts due to vibration. No interruption of electrical continuity longer than 1 microsecond.			MIL-STD-1344 Method 2005 Test Cond. 4
Shock	No damage and no loosening of parts. No interruption of electrical continuity longer than 1 microsecond.			MIL-STD-1344 Method 2004 Test Cond. E
Durability	No electrical or mechanical defects after 500 cycles of mating and unmating			MIL-STD-1344 Method 2016 200 ± 100 cycles/hour
Salt Spray (Corrosion)	No exposure of base metal due to corrosion which will affect performance. Product will meet further tests as specified.			MIL-STD-1344 Method 1001 Cond. B
Fluid Immersion	20 hours immersion MIL-H-5606 Hydraulic Fluid 20 hours immersion MIL-L-23659 Lubricating Fluid Connectors shall meet mating/unmating force following immersion.			MIL-STD-1344 Method 1016

MIL-C-24308 CROSS-REFERENCE

Military Part Number	Cannon Part Number	Military Part Number	Cannon Part Number	Military Part Number	Cannon Part Number
M24308/1-1	DEMM9S	M24308/2-485	DCMAMY37S-FO	M24308/6-5	DDMAM50SNM
M24308/1-2	DAMM15S	M24308/2-486	DDMAMY50S-FO	M24308/6-6	DEMAMT9SNM
M24308/1-3	DBMM25S	M24308/3-1	DEMAM9P	M24308/6-7	DAMAMT15SNM
M24308/1-4	DCMM37S	M24308/3-2	DAMM15P	M24308/6-8	DBMAMT25SNM
M24308/1-5	DDMM50S	M24308/3-3	DBMM25P	M24308/6-9	DCMAMT37SNM
M24308/1-12	DEMMF9S	M24308/3-4	DCMM37P	M24308/6-10	DDMAMT50SNM
M24308/1-13	DAMMF15S	M24308/3-5	DDMM50P	M24308/6-15	DDMAM78SNM
M24308/1-14	DBMMF25S	M24308/3-12	DEMAM9P	M24308/6-259	DEMAMF9SNM
M24308/1-15	DCMMF37S	M24308/3-13	DAMMF15P	M24308/6-260	DAMAMF15SNM
M24308/1-16	DDMMF50S	M24308/3-14	DBMMF25P	M24308/6-261	DBMAMF25SNM
M24308/1-23	DEMAMY9S	M24308/3-15	DCMMF37P	M24308/6-262	DCMAMF37SNM
M24308/1-24	DAMMY15S	M24308/3-16	DDMMF50P	M24308/6-263	DDMAMF50SNM
M24308/1-25	DBMMY25D	M24308/4-1	DEMAM9P	M24308/6-268	DDMAMF78SNM
M24308/1-26	DCMMY37S	M24308/4-2	DAMAM15P	M24308/6-270	DEMAMFT9SNM
M24308/1-27	DDMMY50S	M24308/4-3	DBMAM25P	M24308/6-271	DAMAMFT15SNM
M24308/2-1	DEMAM9S	M24308/4-4	DCMAM37P	M24308/6-272	DBMAMFT25SNM
M24308/2-2	DAMAM15S	M24308/4-5	DDMAM50P	M24308/6-273	DCMAMFT37SNM
M24308/2-3	DBMAM25S	M24308/4-6	DEMAMT9P	M24308/6-274	DDMAMFT50SNM
M24308/2-4	DCMAM37S	M24308/4-7	DAMAMT15P	M24308/6-281	DEMAM9SNM-FO
M24308/2-5	DDMAM50S	M24308/4-8	DBMAMT25P	M24308/6-282	DAMAM15SNM-FO
M24308/2-6	DEMAMT9S	M24308/4-9	DCMAMT37P	M24308/6-283	DBMAM25SNM-FO
M24308/2-7	DAMAMT15S	M24308/4-10	DDMAMT50P	M24308/6-284	DCMAM37SNM-FO
M24308/2-8	DBMAMT25S	M24308/4-15	DDMAM78P	M24308/6-285	DDMAM50SNM-FO
M24308/2-9	DCMAMT37S	M24308/4-259	DEMAM9P-FO	M24308/6-290	DDMAM78SNM-FO
M24308/2-10	DDMAMT50S	M24308/4-260	DAMAM15P-FO	M24308/6-324	DEMAMF9SNM-FO
M24308/2-15	DDMAM78S	M24308/4-261	DBMAM25P-FO	M24308/6-325	DAMAMF15SNM-FO
M24308/2-23	DEMAMF9S	M24308/4-262	DCMAM37P-FO	M24308/6-326	DBMAMF25SNM-FO
M24308/2-24	DAMAMF15S	M24308/4-263	DDMAM50P-FO	M24308/6-327	DCMAMF37SNM-FO
M24308/2-25	DBMAMF25S	M24308/4-268	DDMAM78P-FO	M24308/6-328	DDMAMF50SNM-FO
M24308/2-26	DCMAMF37S	M24308/4-302	DEMAMF9P	M24308/6-333	DDMAMF78SNM-FO
M24308/2-27	DDMAMF50S	M24308/4-303	DAMAMF15P	M24308/6-453	DEMAMY9SNM
M24308/2-32	DDMAMF78S	M24308/4-304	DBMAMF25P	M24308/6-454	DAMAMY15SNM
M24308/2-34	DEMAMFT9S	M24308/4-305	DCMAMF37P	M24308/6-455	DBMAMY25SNM
M24308/2-35	DAMAMFT15S	M24308/4-306	DDMAMF50P	M24308/6-456	DCMAMY37SNM
M24308/2-36	DBMAMFT25S	M24308/4-311	DCMAMF78P	M24308/6-457	DDMAMY50SNM
M24308/2-37	DCMAMFT37S	M24308/4-313	DEMAMFT9P	M24308/6-464	DEMAMYT9SNM
M24308/2-38	DDMAMFT50S	M24308/4-314	DAMAMFT15P	M24308/6-465	DAMAMYT15SNM
M24308/2-281	DEMAM9S-FO	M24308/4-315	DDMAMFT25P	M24308/6-466	M24308/6-466
M24308/2-282	DAMAM15S-FO	M24308/4-316	DCMAMFT37P	M24308/6-467	DCMAMYT37SNM
M24308/2-283	DBMAM25S-FO	M24308/4-317	DDMAMFT50P	M24308/6-468	DDMAMYT50SNM
M24308/2-284	DCMAM37S-FO	M24308/4-324	DEMAMF9P-FO	M24308/6-491	DEMAMY9SNM-FO
M24308/2-285	DDMAM50S-FO	M24308/4-325	DAMAMF15P-FO	M24308/6-492	DAMAMY15SNM-FO
M24308/2-290	DDMAM78S-FO	M24308/4-326	DBMAMF25P-FO	M24308/6-493	DBMAMY25SNM-FO
M24308/2-292	DEMAMF9S-FO	M24308/4-327	DCMAMF37P-FO	M24308/6-494	DCMAMY37SNM-FO
M24308/2-293	DAMAMF15S-FO	M24308/4-328	DDMAMF50P-FO	M24308/6-495	DDMAMY50SNM-FO
M24308/2-294	DBMAMF25S-FO	M24308/4-333	DDMAMF78P-FO	M24308/7-1	DEMAM9PNM
M24308/2-295	DCMAMF37S-FO	M24308/5-1	DEMAM9SNM	M24308/7-2	DAMM15PNM
M24308/2-296	DDMAMF50S-FO	M24308/5-2	DAMM15SNM	M24308/7-3	DBMM25PNM
M24308/2-301	DDMAMF78S-FO	M24308/5-3	DBMM25SNM	M24308/7-4	DCMM37PNM
M24308/2-335	DBMAMR25S	M24308/5-4	DCMM37SNM	M24308/7-5	DDMM50PNM
M24308/2-336	DCMAMR37S	M24308/5-5	DDMM50SNM	M24308/7-12	DEMMF9PNM
M24308/2-341	DAMAMR15S	M24308/5-12	DEMMF9SNM	M24308/7-13	DAMMF15PNM
M24308/2-342	DEMAMY9S	M24308/5-13	DAMMF15SNM	M24308/7-14	DBMMF25PNM
M24308/2-343	DAMAMY15S	M24308/5-14	DBMMF25SNM	M24308/7-15	DCMMF37PNM
M24308/2-344	DBMAMY25S	M24308/5-15	DCMMF37SNM	M24308/7-16	DDMMF50PNM
M24308/2-345	DCMAMY37S	M24308/5-16	DDMMF50SNM	M24308/8-1	DEMAM9PNM
M24308/2-346	DDMAMY50S	M24308/5-23	DEMAM9SNM	M24308/8-2	DAMAM15PNM
M24308/2-353	DEMAMYT9S	M24308/5-24	DAMMY15SNM	M24308/8-3	DBMAM25PNM
M24308/2-354	DAMAMYT15S	M24308/5-25	DBMMY25SNM	M24308/8-4	DCMAM37PNM
M24308/2-355	DBMAMYT25S	M24308/5-26	DCMMY37SNM	M24308/8-5	DDMAM50PNM
M24308/2-356	DCMAMYT37S	M24308/5-27	DDMMY50SNM	M24308/8-6	DEMAMT9PNM
M24308/2-357	DDMAMYT50S	M24308/6-1	DEMAM9SNM	M24308/8-7	DAMAMT15PNM
M24308/2-482	DEMAMY9S-FO	M24308/6-2	DAMAM15SNM	M24308/8-8	DBMAMT25PNM
M24308/2-483	DAMAMY15S-FO	M24308/6-3	DBMAM25SNM	M24308/8-9	DCMAMT37PNM
M24308/2-484	DBMAMY25S-FO	M24308/6-4	DCMAM37SNM	M24308/8-10	DDMAMT50PNM

MIL-C-24308 CROSS-REFERENCE (Continued)

Military Part Number	Cannon Part Number
M24308/8-15	DDMAM78PNM
M24308/8-259	DEMAM9PNM-FO
M24308/8-260	DAMAM15PNM-FO
M24308/8-261	DBMAM25PNM-FO
M24308/8-262	DCMAM37PNM-FO
M24308/8-263	DDMAM50PNM-FO
M24308/8-269	DDMAM78PNM-FO
M24308/8-302	DEMAMF9PNM
M24308/8-303	DAMAMF15PNM
M24308/8-304	DBMAMF25PNM
M24308/8-305	DCMAMF37PNM
M24308/8-306	DDMAMF50PNM
M24308/8-311	DDMAMF78PNM
M24308/8-313	DEMAMFT9PNM
M24308/8-314	DAMAMFT15PNM
M24308/8-315	DBMAMFT25PNM
M24308/8-316	DCMAMFT37PNM
M24308/8-317	DDMAMFT50PNM
M24308/8-324	DEMAMF9PNM-FO
M24308/8-325	DAMAMF15PNM-FO
M24308/8-326	DBMAMF25PNM-FO
M24308/8-327	DCMAMF37PNM-FO
M24308/8-328	DDMAMF50PNM-FO
M24308/8-333	DDMAMF78PNM-FO
M24308/9-1	DEH9P002
M24308/9-2	DAH15P002
M24308/9-3	DBH25P002
M24308/9-4	DCH37P002
M24308/9-5	DDH50P002
M24308/9-6	DEH9P001
M24308/9-7	DAH15P001
M24308/9-8	DBH25P001
M24308/9-9	DCH37P001
M24308/9-10	DDH50P001
M24308/9-11	DEH9P202
M24308/9-12	DAH15P202
M24308/9-13	DBH25P202
M24308/9-14	DCH37P202
M24308/9-15	DDH50P202
M24308/9-16	DEH9P201
M24308/9-17	DAH15P201
M24308/9-18	DBH25P201
M24308/9-19	DCH37P201
M24308/9-20	DDH50P201
M24308/23-1	DEMM9SM
M24308/23-2	DAMM15SM
M24308/23-3	DBMM25SM
M24308/23-4	DCMM37SM
M24308/23-5	DDMM50SM
M24308/23-7	DEMM9SZ

Military Part Number	Cannon Part Number
M24308/23-8	DAMM15SZ
M24308/23-9	DBMM25SZ
M24308/23-10	DCMM37SZ
M24308/23-11	DDMM50SZ
M24308/23-13	DEMM9SH
M24308/23-14	DAMM15SH
M24308/23-15	DBMM25SH
M24308/23-16	DCMM37SH
M24308/23-17	DDMM50SH
M24308/23-19	DEMM9SX
M24308/23-20	DAMM15SX
M24308/23-21	DBMM25SX
M24308/23-22	DCMM37SX
M24308/23-23	DDMM50SX
M24308/23-25	DEMM9SD
M24308/23-26	DAMM15SD
M24308/23-27	DBMM25SD
M24308/23-28	DCMM37SD
M24308/23-29	DDMM50SD
M24308/23-31	DEMM9SL
M24308/23-32	DAMM15SL
M24308/23-33	DBMM25SL
M24308/23-34	DCMM37SL
M24308/23-35	DDMM50SL
M24308/23-37	DEMM9SA
M24308/23-38	DAMM15SA
M24308/23-39	DBMM25SA
M24308/23-40	DCMM37SA
M24308/23-41	DDMM50SA
M24308/23-43	DEMM9SG
M24308/23-44	DAMM15SG
M24308/23-45	DBMM25SG
M24308/23-46	DCMM37SG
M24308/23-47	DDMM50SG
M24308/23-49	DEMM9SS
M24308/23-50	DAMM15SS
M24308/23-51	DBMM25SS
M24308/23-52	DCMM37SS
M24308/23-53	DDMM50SS
M24308/23-55	DEMM9SW
M24308/23-56	DAMM15SW
M24308/23-57	DBMM25SW
M24308/23-58	DCMM37SW
M24308/23-59	DDMM50SW
M24308/24-1	DEMM9PM
M24308/24-2	DAMM15PM
M24308/24-3	DBMM25PM
M24308/24-4	DCMM37PM
M24308/24-5	DDMM50PM
M24308/24-7	DEMM9PZ

Military Part Number	Cannon Part Number
M24308/24-8	DAMM15PZ
M24308/24-9	DBMM25PZ
M24308/24-10	DCMM37PZ
M24308/24-11	DDMM50PZ
M24308/24-13	DEMM9PH
M24308/24-14	DAMM15PH
M24308/24-15	DBMM25PH
M24308/24-16	DCMM37PH
M24308/24-17	DDMM50PH
M24308/24-19	DEMM9PX
M24308/24-20	DAMM15PX
M24308/24-21	DBMM25PX
M24308/24-22	DCMM37PX
M24308/24-23	DDMM50PX
M24308/24-25	DEMM9PD
M24308/24-26	DAMM15PD
M24308/24-27	DBMM25PD
M24308/24-28	DCMM37PD
M24308/24-29	DDMM50PD
M24308/24-31	DEMM9PL
M24308/24-32	DAMM15PL
M24308/24-33	DBMM25PL
M24308/24-34	DCMM37PL
M24308/24-35	DDMM50PL
M24308/24-37	DEMM9PA
M24308/24-38	DAMM15PA
M24308/24-39	DBMM25PA
M24308/24-40	DCMM37PA
M24308/24-41	DDMM50PA
M24308/24-43	DEMM9PG
M24308/24-44	DAMM15PG
M24308/24-45	DBMM25PG
M24308/24-46	DCMM37PG
M24308/24-47	DDMM50PG
M24308/24-49	DEMM9PS
M24308/24-50	DAMM15PS
M24308/24-51	DBMM25PS
M24308/24-52	DCMM37PS
M24308/24-53	DDMM50PS
M24308/24-55	DEMM9PW
M24308/24-56	DAMM15PW
M24308/24-57	DBMM25PW
M24308/24-58	DCMM37PW
M24308/24-59	DDMM50PW
M24308/26-1	D20418-2
M24308/26-2	D20418-39

MIL-C-85049 CROSS-REFERENCE

Military Part Number	Cannon Part Number
M85049/48-1-1	DA24657
M85049/48-1-2	DB24658
M85049/48-1-3	DC24659
M85049/48-1-4	DD24660
M85049/48-1-5	DE24661
M85049/48-1-6	DA24657-5
M85049/48-1-7	DB24658-2
M85049/48-1-8	DC24659-2
M85049/48-1-9	DD24660-11
M85049/48-1-10	DE24661-4
M85049/48-2-1	DA44994
M85049/48-2-2	DB20961
M85049/48-2-3	DC20962
M85049/48-2-4	DD20963
M85049/48-2-5	DE20964

Military Part Number	Cannon Part Number
M85049/48-2-6	DA44994-3
M85049/48-2-7	DB20961-3
M85049/48-2-8	DC20962-8
M85049/48-2-9	DD20963-81
M85049/48-2-10	DE20964-8
M85049/48-3-2	DA19678-1
M85049/48-3-3	DB19678-2
M85049/48-3-4	DC19678-3
M85049/48-3-5	DD19678-4
M85049/48-3-7	DA19678-38
M85049/48-3-8	DB19678-53
M85049/48-3-9	DC19678-85
M85049/48-3-10	DD19678-85
M85049/50-1	DE19977-5
M85049/50-2	DA19977-1

Military Part Number	Cannon Part Number
M85049/50-3	DB19977-2
M85049/50-4	DC19977-3
M85049/50-5	DD19977-4
M85049/50-6	DE19977-20
M85049/50-7	DA19977-6
M85049/50-8	DB19977-17
M85049/50-9	DC19977-18
M85049/50-10	DD19977-19

INDEX

Part Number	Page	Part Number	Page	Part Number	Page	Part Number	Page
ABT-500	11	DA22214	61	DC-59-20	62	DDMA-30WS7S	39
ABT-607	11	DA24658	57	DC-60-20	62	DDMA-50P	39
ABT-620	11	DA50905-1	59	DCBMA-37PS	50	DDMA-50S	39
CBT-491	11	DA51210	58	DCC-37P	7	DDMA-78P	39
CBT-565	11	DA51211	58	DCC-37S	7	DDMA-78S	39
CCT-D+C-1	11	DA51220-1	60	DCD-37PA	52	DDMA110355	44
CCT-D+C-4	11	DA53750-1	62	DCD-37SA	52	DDMA110336	44
CCT-D+C-10	11	DA59104	25	DCDA-37P	52	DDP-50PAA	20
CCT-DM	38,45	DB-25P	4	DCDA-37S	52	DDP-50SAA	20
CCT-Hx4	27	DB-25S	4	DCM-8W8P	29	DDPF-50PY4	22
CET-C6B	38	DB-59-20	62	DCM-8W8S	29	DDPF-50SY4	22
CET-20-11	43	DB-60-20	62	DCM-13W6P	29	DDU-50P	7
CET-20-15	43	DBBMA-25PS	50	DCM-13W6S	29	DDU-50S	7
CET-20D	11	DBC-25P	7	DCM-17W5P	29	DD110963-5	57
CET-20HD	11,43	DBC-25S	7	DCM-17W5S	29	DD115339	58
CET-20HDL	48	DBD-25PA	52	DCM-21WA4P	29	DD115339-4	58
CET-22D	43	DBD-255A	52	DCM-21WA4S	29	DD115339-24	57
CPP-460	16	DBDA-25P	52	DCM-25W3P	29	DD115386-5A	58
CPT-D+C	11	DBDA-25S	52	DCM-25W3S	29	DD115386-92	28
DA-15P	4	DBM-5W5P	29	DCMA-37P	39	DD121073-53	28
DA-15S	4	DBM-5W5S	29	DCMA-37S	39	DD19678-9	59
DA-59-20	62	DBM-9W4P	29	DCP-37PAA	20	DD19678-13	59
DA-60-20	62	DBM-9W4S	29	DCP-37PCA	20	DD19977-4	57
DABMA-15PS	50	DBM-13W3P	29	DCP-37SAA	20	DD20964	56
DAC-15P	7	DBM-13W3S	29	DCP-37SCA	20	DD21961	61
DAC-15S	7	DBM-17W2P	29	DCPF-37PY4	22	DD21962	61
DAD-15PA	52	DBM-17W2S	29	DCPF-37SY4	22	DD24661	57
DAD-15SA	52	DBM-21W1P	29	DCSF-37P	15	DD50908-1	59
DADA-15P	52	DBM-21W1S	29	DCSF-37S	15	DD51216	58
DADA-15S	52	DBM-25P	29	DCU-37P	7	DD51217	58
DAM-3W3P	29	DBM-25S	29	DCU-37S	7	DD51223-1	60
DAM-3W3S	29	DBMA-13W3P	39	DC110963-4	57	DD53750-4	62
DAM-7W2P	29	DBMA-13W3S	39	DC111403	25	DE-9P	4
DAM-7W2S	29	DBMA-17W2P	39	DC111411	25	DE-9S	4
DAM-15P	29	DBMA-17W2S	39	DC115339-3	58	DE-59-20	62
DAM-15S	29	DBMA-25P	39	DC115386-4A	58	DE-60-20	62
DAMA-7W2P	39	DBMA-25S	39	DC115386-82	28	DEBMA-9PS	50
DAMA-7W2S	39	DBP-25PAA	20	DC115398-3	62	DEC-9P	7
DAMA-11W1P	39	DBP-25PCA	20	DD1C5398-4	62	DEC-9S	7
DAMA-11W1S	39	DBP-25SAA	20	DC115339-23	57	DED-9PA	52
DAMA-15P	39	DBP-25SCA	20	DC121073-52	28	DED-9PB	52
DAMA-15S	39	DBPF-25SY4	22	DC19678-8	59	DED-9SA	52
DAP-15PAA	20	DBPR-25PY4	22	DC19678-12	59	DED-9SB	52
DAP-15SAA	20	DBSF-25P	15	DC19977-3	57	DEDA-9P	52
DAP-15SCA	20	DBSF-25S	15	DC20963	56	DEDA-9S	58
DAP-15PCA	20	DBU-25P	7	DC22070	61	DEM-5W1P	29
DAPF-15PY4	22	DBU-25S	7	DC22071	61	DEM-5W1S	29
DAPF-15SY4	22	DB110963-3	57	DC24660	57	DEM-9P	29
DASF-15P	15	DB111402	25	DC50907-1	59	DEM-9S	29
DASF-15S	15	DB111410	25	DC51214	58	DEMA-9P	39
DAU-15P	7	DB115339-2	58	DC51215	58	DEMA-9S	39
DAU-15S	7	DB115339-22	57	DC51222-1	60	DEP-9PAA	20
DA110963-2	57	DB115386-3A	58	DC53750-3	62	DEP-9PCA	20
DA111401	25	DB115386-72	28	DC59106	25	DEP-9SAA	20
DA111409	25	DB115398-2	62	DD-50P	4	DEP-9SCA	20
DA11539-1	58	DB121073-51	28	DD-50S	4	DESF-9P	15
DA115339-21	57	DB19678-7	59	DD-59-20	62	DESF-9S	15
DA115386-2A	58	DB19678-11	59	DD-60-20	62	DEU-9P	7
DA115398-1	62	DB19977-2	57	DDBMA-50PS	50	DEU-9S	7
DA121073-50	28	DB20962	56	DCC-50P	7	DE110963-1	57
DA19678-1	56	DB22254	61	DDC-50S	7	DE115339-20	57
DA19678-2	56	DB22255	61	DDD-50PA	52	DE115386-1A	58
DB19678-3	56	DB24659	57	DDD-50SA	52	DE115398	62
DC19678-4	56	DB50906-1	59	DDDA-50P	52	DE121073-54	28
DD19678-6	59	DB51212	58	DDDA-50S	52	DE19977-5	57
DA19678-10	59	DB51213	58	DDM-24W7P	29	DE24657	57
DA19977-1	57	DB51221-1	60	DDM-24W7S	29	DE44994	56
DA20961	56	DB51226-1A	57	DDM-36W4P	29	DE50904-1	59
DA22213	61	DB53750-2	62	DDM-36W4S	29	DE51218	58
		DB59105	25	DDM-43W2P	29	DE51224-1	60
		DC-37P	4	DDM-43W2S	29	DE53750	62
		DC-37S	4	DDMA 30WS7P	39	DMA43716	44

INDEX

Part Number	Page	Part Number	Page	Part Number	Page	Part Number	Page
DMA43716-1	44	DM53740-5000	35	D110238-35	10	029-8757-009	15
DMA43716-2	44	DM53740-5001	35	D110238-165	10	029-8757-015	18
DMA43716-3	44	DM53740-5005	35	D110238-166	10	029-8757-025	18
DMA43716-4	44	DM53740-5008	35	D110238-428	10	029-8757-037	18
DMA43716-5	44	DM53740-5099	35	D110238-434	10	030-1952-000	10
DMA43716-6	44	DM53740-5100	35	D110238-431	10	030-1952-002	10
DMA43716-7	44	DM53740-5101	35	D110238-436	10	030-1953-000	10
DMA43717	44	DM53740-5104	35	D110277	61	030-1953-002	10
DMA43717-1	44	DM53740-5105	35	D110278	61	030-1954-000	10
DMA43717-2	44	DM53741	36	D110279	61	030-1955-000	10
DMA43717-3	44	DM53741-1	36	D110280	61	030-1989-000	13
DMA43717-4	44	DM53741-3	36	D110550	60	030-1990-000	13
DMA43717-5	44	DM53741-4	36	D110551	60	030-2042-002	43
DMA43717-6	44	DM53741-10	36	D20418-2	60	030-2042-000	43
DMA43717-7	44	DM53741-11	36	D20418-50	60	030-2086-000	13
DMA43718	44	DM53741-12	36	D20418-39	60	030-2087-000	13
DMA43718-1	44	DM53741-13	36	D20418-74	60	030-2088-000	13
DMA43718-2	44	DM53741-5000	35	D20419	60	030-2089-000	13
DMA43718-3	44	DM53741-5001	35	D20419-18	60	030-2090-000	13
DMA43718-4	44	DM53741-5003	35	D20419-21	60	030-2091-000	13
DMA43718-5	44	DM53741-5004	35	D20420	60	031-1007-000	43
DMA43718-6	44	DM53741-5059	35	D20420-13	60	031-1007-001	43
DMA43718-7	44	DM53741-5060	35	D20420-15	60	031-1007-004	43
DMA43719	44	DM53741-5062	35	D20420-86	60	031-1007-042	43
DMA43719-1	44	DM53741-5063	35	D53018	60	031-1007-054	43
DMA43719-2	44	DM53742	35	D53018-5	60	031-1007-048	43
DMA43719-3	44	DM53742-1	35	EDAL15SBA1	17	031-1147-000	43
DMA43719-4	44	DM53742-3	35	EDAL15SBA2	17	031-1147-002	43
DMA43719-5	44	DM53742-5	35	EDBL25SBA1	17	070051-0000	38
DMA43719-6	44	DM53742-18	35	EDSL15SBA2	17	070064-0000	38,45
DMA44157	44	DM53742-16	35	EDBM25SBA1	17	121086-0041	16
DMA44159	44	DM53742-17	35	EDBM25SBA2	17	121086-1620	16
DMA44157-2	44	DM53742-19	35	EDEL9SBA1	17	250-8501-004	28
DMA44159-2	44	DM53742-5000	35	EDEL9SBA2	17	274-5016-002	43
DMA44348	44	DM53742-5001	35	EDEM9SBA1	17	274-7003-000	43
DMA44349	44	DM53742-5002	35	EDEM9SBA2	17	274-7006-000	43
DMA44350	44	DM53742-5004	35	EDGL19SBA1	17	274-7010-000	48
DMA44351	44	DM53742-5006	35	EDGL19SBA2	17	274-7048-000	43
DMA44352	44	DM53742-5085	35	EDGM19SBA1	17	317-1389-000	62
DMA44353	44	DM53742-5086	35	EDGM19SBA2	17	323-7010-000	43
DMA44348-1	44	DM53742-5089	35	GDA-15P	47	330-5291-000	43
DMA44349-1	44	DM53742-5091	35	GDA-15S	47	330-5291-001	43
DMA44350-1	44	DM53742-5092	35	GDB-25P	47	330-5291-004	43
DMA44351-1	44	DM53743-2	36	GDB-25S	47	330-5291-015	55
DMA44352-1	44	DM53743-3	36	GDD-50P	47	330-5291-037	43
DMA44353-1	44	DM53743-5	36	GDD-50S	47	330-5291-050	43
DMA51235-1	62	DM53743-6	36	GDE-9P	47	330-5291-055	43
DMA51236-1	62	DM53743-16	36	GDE-9S	47	330-5291-079	55
DM121073-200	36	DM53743-17	36	K250	43	980-0005-722	43
DM121073-201	36	DM53743-18	36	L3198-20HD	43	995-0001-244	43
DM121073-202	36	DM53743-19	36	L3198-20HDL	11	995-0001-325	43
DM121073-203	36	DM53743-5000	35	M24308	68	995-0001-377	11
DM121073-210	36	DM53743-5001	35	M39029	43	995-0001-355	11
DM121073-211	36	DM53743-5003	35	M85049	71	995-0001-584	11
DM121073-212	36	DM53743-5004	35	M22520/1-01	11	995-0001-595	11
DM121073-213	36	DM53743-5073	35	M22520/1-05	43	995-0001-604	43
DM51155	37	DM53743-5074	35	M22520/2-01	11,43	995-0001-662	11
DM51155-7	37	DM53743-5076	35	M22520/2-06	43	995-0001-695	11
DM51155-5000	37	DM53743-5077	35	M22520/2-08	43	995-0001-739	43
DM51155-5004	37	DM53744-1	37	M39029/63-368	43	995-0001-761	27
DM51157	37	DM53744-6	37	M39029/64-369	43	995-0001-870	11
DM51157-8	37	DM53744-7	37	TH25	43	995-0001-878	27
DM51157-5000	37	DM53744-21	37	TH185	11	995-0001-885	27
DM51157-5005	37	DM53744-24	37	015-0338-000	62	995-0002-046	27
DM53740	35	DM53744-25	37	015-0339-000	62	995-0002-107	11
DM53740-1	35	DM53745-1	37	015-0340-000	62		
DM53740-3	35	DM53745-7	37	015-0341-000	62		
DM53740-5	35	DM53745-8	37	015-0342-000	62		
DM53740-15	35	DM53745-25	37	015-0348-000	62		
DM53740-16	35	DM53745-27	37	015-0349-000	62		
DM53740-18	35	DM53745-28	37	015-0350-000	62		
DM53740-17	35	D110238-34	10	015-0351-000	62		

Данный компонент на территории Российской Федерации

Вы можете приобрести в компании MosChip.

Для оперативного оформления запроса Вам необходимо перейти по данной ссылке:

<http://moschip.ru/get-element>

Вы можете разместить у нас заказ для любого Вашего проекта, будь то серийное производство или разработка единичного прибора.

В нашем ассортименте представлены ведущие мировые производители активных и пассивных электронных компонентов.

Нашей специализацией является поставка электронной компонентной базы двойного назначения, продукции таких производителей как XILINX, Intel (ex.ALTERA), Vicor, Microchip, Texas Instruments, Analog Devices, Mini-Circuits, Amphenol, Glenair.

Сотрудничество с глобальными дистрибьюторами электронных компонентов, предоставляет возможность заказывать и получать с международных складов практически любой перечень компонентов в оптимальные для Вас сроки.

На всех этапах разработки и производства наши партнеры могут получить квалифицированную поддержку опытных инженеров.

Система менеджмента качества компании отвечает требованиям в соответствии с ГОСТ Р ИСО 9001, ГОСТ РВ 0015-002 и ЭС РД 009

Офис по работе с юридическими лицами:

105318, г.Москва, ул.Щербаковская д.3, офис 1107, 1118, ДЦ «Щербаковский»

Телефон: +7 495 668-12-70 (многоканальный)

Факс: +7 495 668-12-70 (доб.304)

E-mail: info@moschip.ru

Skype отдела продаж:

moschip.ru

moschip.ru_4

moschip.ru_6

moschip.ru_9