

Sockets & Accessories, R10 Relays

- Sockets for 2 - 6 pole relays
- Solder, PCB or screw terminal sockets
- Choice of grounding provision on sockets
- Hold down springs
- Plates and brackets permit various mounting options



Approvals

UL E59244, CSA LR15734
Technical data of approved types on request

Technical Data

Socket contact material	Spring brass, tin plated
Socket body material	
2 and 4 pole models	Polyester
6 and 8 pole models	Phenolic
Maximum current	10A
Voltage drop	30mV max. at 10A
Dielectric strength	1,000Vrms
Insulation resistance	10 ⁹ megΩ

Solder and PC terminal sockets

Rugged, molded socket body retains floating terminals of either solder or printed circuit pin configuration. PC terminal sockets are offered with pins in either 0.1" (2.54mm) grid or in-line arrangement.

Grounding provisions

Pre-installed on sockets

Not for use at 5A AC and above.

Grounding Strip: Mounting stud of relay contacts grounding strip. Grounding strip is grounded with screw or rivet through round hole in socket.

Grounding Terminal (PC sockets only): Mounting stud of relay contacts ground terminal through square hole in socket.

Strip

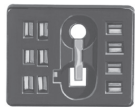

Terminal



Ordering Code



Product Code	Poles	Terminal type	Grounding provision	Part number
27E125	2	solder terminals	strip	1393143-8
27E126	4			1393143-9
27E127	6			1-1393143-0
27E162	2		none	1-1393143-6
27E163	4			1-1393143-7
27E164	6			1-1393143-8
27E128	2	PCB terminals, .180"	strip	1-1393143-1
27E129	4	(4.57mm) long,		1-1393143-2
27E130	6	staggered layout		1-1393143-3
27E212	2		none	2-1393143-4
27E213	4			2-1393143-5
27E271	6			3-1393143-1
27E193	2		terminal	2-1393143-1
27E194	4			2-1393143-2
27E636	2	PCB terminals, 210"	strip	5-1393143-0
27E637	4	(5.33mm) long,		5-1393143-1
		staggered layout		
27E342	2	PCB terminals, .180"	none	3-1393143-6
27E629	4	(4.57mm) long,		4-1393143-8
27E630	6	in-line layout		4-1393143-9

All accessories must be ordered separately.

Caution:

Printed circuit sockets are manufactured with "floating" (loose) terminals. This permits them to align with holes in the circuit board and with the relay terminals. During the mounting and soldering of the socket, vertical float should be eliminated and the terminals seated on the board. (This may be accomplished by inserting a dummy relay in the socket.) Failure to eliminate float may cause fracture of the solder joint or separation of the copper conductor from the printed circuit board when a relay is inserted in the socket after soldering.

Sockets & Accessories, R10 Relays (Continued)

Dimensions

Solder and PC terminal sockets

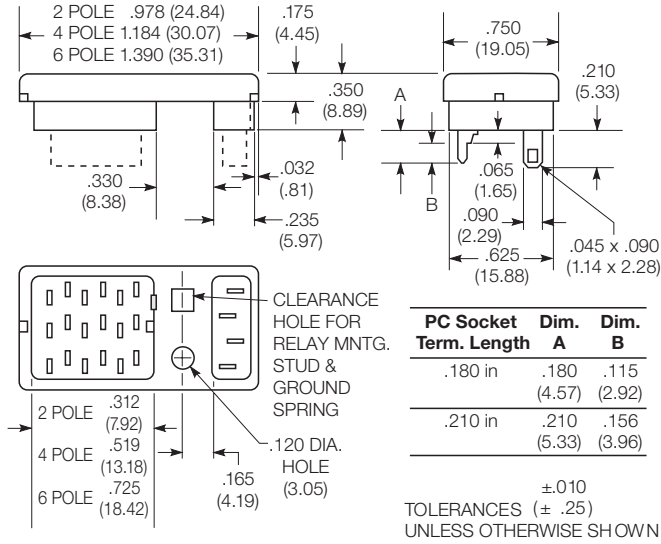

PCB layout

Sockets with staggered PC terminals

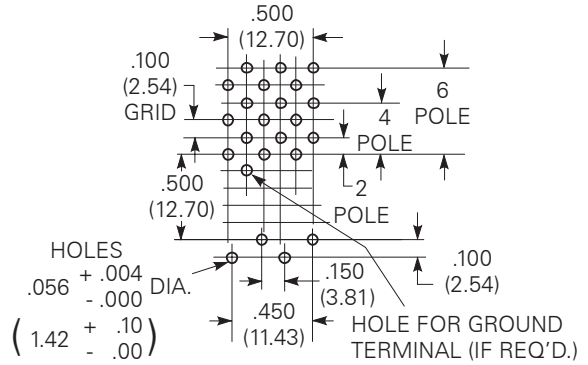

PCB layout (top view)

Sockets with solder terminals

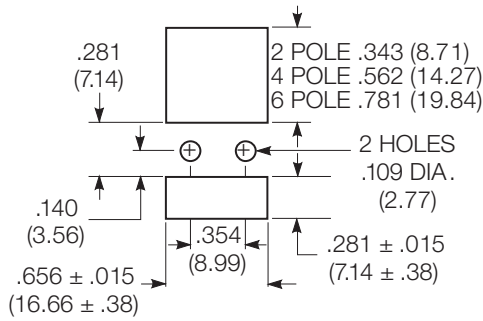

Sockets with inline PC terminals

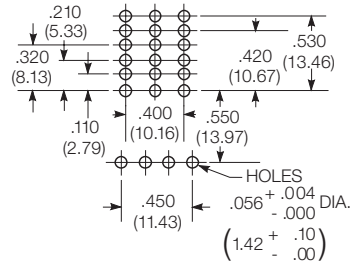

Sockets & Accessories, R10 Relays (Continued)

Ordering Code

Product Code	Poles	Terminal type	Mount type	Grounding provision	Part number
27E317	2	solder	bracket	strip	3-1393143-4
27E152	4				1-1393143-5
27E446	2	solder	flange	strip	4-1393143-1
27E447	4				4-1393143-2
27E448	6				4-1393143-3
27E460	2	screw	track/ chassis	none	1393837-1
27E461	4				4-1393143-4
27E462	6				4-1393143-5

All accessories must be ordered separately.

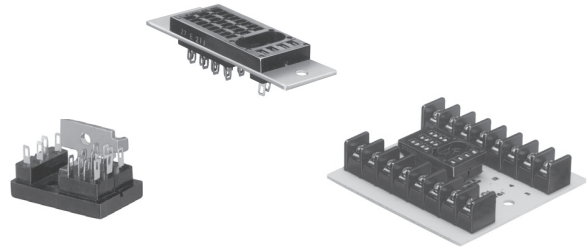

Dimensions

Bracket Mount socket 27E317 and 27E152
Allows solder terminal relay to mount flat on a chassis.

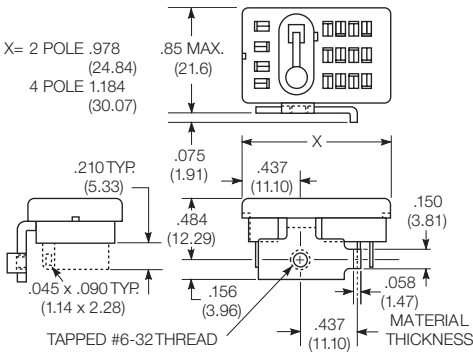

Flange mount socket 27E446, 27E447, 27E448
Solder terminal socket with tin-plated terminals and grounding strip pre-assembled on .065" (1.65mm) steel mounting plate. Requires only one chassis cutout.

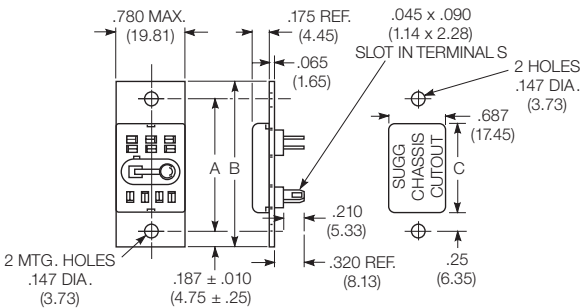

Track mount sockets 27E460, 27E461, 27E462
Provides front wiring, screw terminal connections for R10 family relays. No grounding provision.

2 pole terminal wiring code

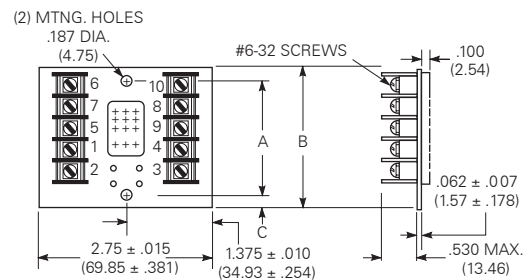

Socket	Poles	Dim A	Dim B	Dim C
27E446	2	1.437 (36.50)	1.822 (46.27)	.937 (23.80)
27E447	4	1.687 (42.85)	2.072 (52.63)	1.125 (28.58)
27E448	6	1.875 (47.63)	2.260 (57.40)	1.343 (34.11)

4 pole terminal wiring code

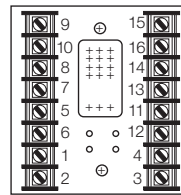

Suggested track mounting

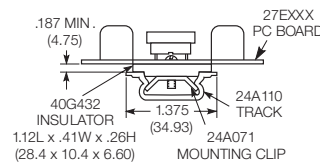

6 pole terminal wiring code

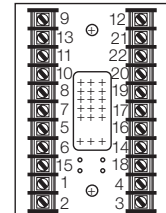

Suggested chassis mounting

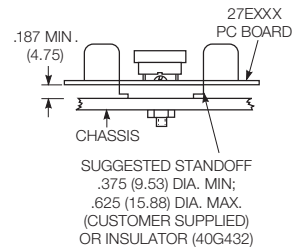

Sockets & Accessories, R10 Relays (Continued)

Ordering Code

Product Code	Description	Part number
20C249	Hold down spring for 2 pole R10 relays	3-1393159-5
20C250	Hold down spring for 4 pole R10 relays	3-1393159-6
20C251	Hold down spring for 6 pole R10 relays	3-1393159-7
20C266	Hold down spring for 8 pole R10 relays	4-1393159-1
20C259	Hold down strap for R10 relays in PC sockets	4-1393159-0
20C300	Hold down spring for 2 pole R10S relays	4-1393159-4
20C301	Hold down spring for 4 pole R10S relays	4-1393159-5
37D645	Mounting strip - accepts 10 relays or sockets	7-1393143-3
24A110	Mounting track	1419111-6
24A071	Steel mounting clip with #6-32 screw - use with 27E46_ sockets on 24A110 track	1419111-5
40G432	Plastic insulator - use with use with 27E46_ sockets on chassis or with 24A071 clip on 24A110 track	9-1393159-5

All accessories must be ordered separately.

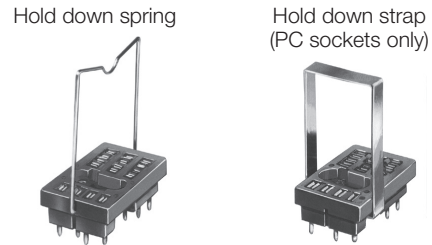

Dimensions

37D645 – Mounting Strip

Strip of .060" (1.52mm) aluminum contains ten pre-punched, breakaway mounting plates. Each plate accommodates a 2, 4, 6 or 8 pole solder terminal R10 relay or socket to facilitate chassis- or rack mounting.

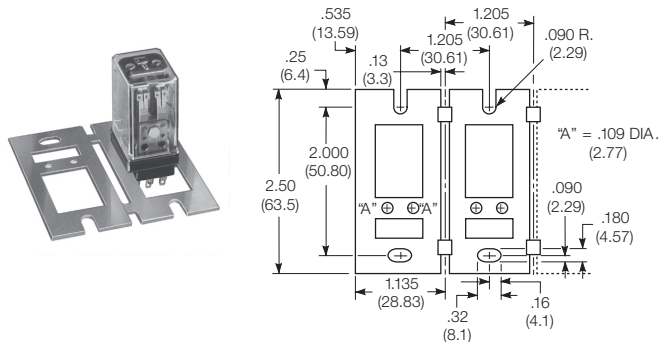

24A110 – Mounting track

Mounting track is designed to accept snap-mount sockets, as well as other P&B screw terminal sockets. Track is made of lightweight, sturdy extruded aluminum and is shipped in three-foot (914cm) lengths with mounting holes on six-inch (152mm) centers. Track can be cut to shorter lengths or used end-to-end.

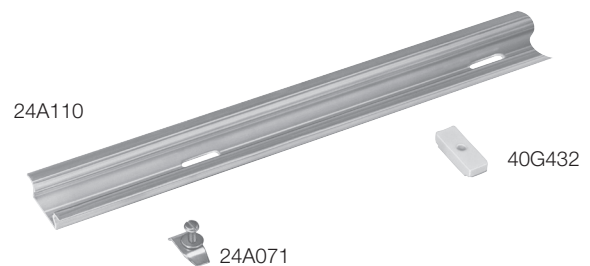
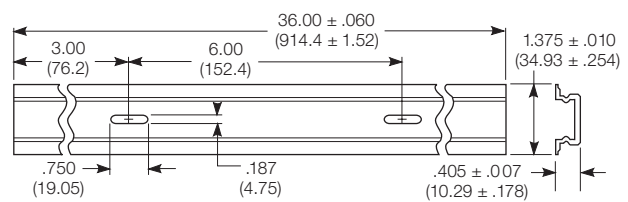

Данный компонент на территории Российской Федерации

Вы можете приобрести в компании MosChip.

Для оперативного оформления запроса Вам необходимо перейти по данной ссылке:

<http://moschip.ru/get-element>

Вы можете разместить у нас заказ для любого Вашего проекта, будь то серийное производство или разработка единичного прибора.

В нашем ассортименте представлены ведущие мировые производители активных и пассивных электронных компонентов.

Нашей специализацией является поставка электронной компонентной базы двойного назначения, продукции таких производителей как XILINX, Intel (ex.ALTERA), Vicor, Microchip, Texas Instruments, Analog Devices, Mini-Circuits, Amphenol, Glenair.

Сотрудничество с глобальными дистрибьюторами электронных компонентов, предоставляет возможность заказывать и получать с международных складов практически любой перечень компонентов в оптимальные для Вас сроки.

На всех этапах разработки и производства наши партнеры могут получить квалифицированную поддержку опытных инженеров.

Система менеджмента качества компании отвечает требованиям в соответствии с ГОСТ Р ИСО 9001, ГОСТ РВ 0015-002 и ЭС РД 009

Офис по работе с юридическими лицами:

105318, г.Москва, ул.Щербаковская д.3, офис 1107, 1118, ДЦ «Щербаковский»

Телефон: +7 495 668-12-70 (многоканальный)

Факс: +7 495 668-12-70 (доб.304)

E-mail: info@moschip.ru

Skype отдела продаж:

moschip.ru

moschip.ru_4

moschip.ru_6

moschip.ru_9