

embedded LCD-DISPLAY

240x128 WITH INTELLIGENCE

Issue 02.2014



Dimension:
113x70x12mm

TECHNICAL DATA

- * LCD GRAPHICS DISPLAY WITH A RANGE OF GRAPHICS FUNCTIONS
- * 8 BUILT-IN SOFT-FONTS
- * FONT ZOOM FROM approx. 2mm TO approx. 50mm, also ROTATED BY 90°
- * 3 DIFFERENT ONBOARD INTERFACES: RS-232, I²C BUS OR SPI BUS
- * 240x128 PIXELS WITH LED BACKLIGHT, BLUE NEGATIVE OR BLACK&WHITE POSITIVE, FSTN TECHNOLOGY OR AMBER
- * POWER SUPPLY +5V@ TYPICAL 75mA / 210mA (WITHOUT / WITH LED BACKLIGHT)
- * POSITIONING **ACCURATE TO THE PIXEL** WITH ALL FUNCTIONS
- * STRAIGHT LINE, POINT, AREA, AND/OR/EXOR, BAR GRAPH...
- * CLIPBOARD FUNCTIONS, PULL-DOWN MENUS
- * UP TO 256 IMAGES STORABLE INTERNALLY
- * UP TO 256 MACROS PROGRAMMABLE (32 kB EEPROM ONBOARD)
- * COMBINATIONS OF TEXT AND GRAPHICS, FLASHING ATTRIBUTES: ON/OFF/INVERTED
- * BACKLIGHT CAN BE SWITCHED BY SOFTWARE
- * ANALOG TOUCH PANEL: VARIABLE GRID
- * FREELY DEFINABLE KEYS AND SWITCHES

ORDERING CODES

DISPLAYS

240x128 DOTS, WHITE LED-BACKLIGHT, BLUENEGATIVE

AS ABOVE, BUT WITH TOUCH PANEL

240x128 DOTS, WHITE LED-BACKLIGHT, POSITIVE MODE, FSTN

AS ABOVE, BUT WITH TOUCH PANEL

240x128 DOTS, WHITE LED-BACKLIGHT, POSITIVE MODE, FSTN

AS ABOVE, BUT WITH TOUCH PANEL

STARTERKIT

INCLUDES EA eDIP240B-7LWP AND EVALUATION BOARD WITH USB

FOR DIRECT CONNECTION TO PC AND INTERFACE BOARDS FOR

CONNECTION WITH YOUR HOST SYSTEM

AS ABOVE, BUT WITH EA eDIP240J-7LWTP

ADDITIONAL PARTS

MOUNTING BEZEL (ALUMINIUM), BLACK ANODIZED

SOCKET 1x20, 4.5mm HIGH (1 piece)

EA eDIP240B-7LW
EA eDIP240B-7LWTP
EA eDIP240J-7LW
EA eDIP240J-7LWTP
EA eDIP240J-7LA
EA eDIP240J-7LATP

EA EVAL eDIP240B
EA EVAL eDIP240J

EA 0FP241-7SW
EA B254-20

**ELECTRONIC
ASSEMBLY**

making things easy

Documentation of revision				
Date	Type	Old	New	Reason / Description
15.02.04	V1.0			Preliminary version
24.11.04	V1.1	- Modulo 8	New Command Macro-Process #MD../#MZ../#MS.. Adaptor MAX232 circuit diagramm Modulo 256	new firmware - typing error in protocol description
18.01.05	V1.2		New Command Terminal-Cursor Save/Restore #TS/#TR New Command Bargraph send continous #AQ 2	new firmware
07.04.05	V1.3		New addressable 2-wire RS485 Interface with SN75176 New 32 additional I2C Addresses New Commands #AG, #SI, #KA	new firmware
13.05.05	V1.4		Bugfix in SPI- I2C-Mode after wrong Packet (NAK)	new firmware
04.10.05	V1.5		some problems with opertating >60°C (display corrupted) New Protocoll Info Command 'DC2 1 P bcc' Bugfix in #GZ (pointsize), #B RLOU (typ2+3 linewidth)	new firmware
18.10.05	V1.6		OUT-port functionality on not used configuration pins	new firmware
17.02.06	-		Drawing for mounting panel EA 0FP241-7SW included	-
27.04.06	-	V/A 61.0mm	Revised drawing (V/A = 60.4mm and pcb Rev.D)	
29.06.07	-		Insert EA eDIP240J-7LA	

CONTENTS

GENERAL	3
ELECTRICAL SPECIFICATIONS	4
RS-232	5
SPI	6
I ² C	7
SOFTWARE PROTOCOL	8-9
TOUCH PANEL	10
CHARACTERSETS	11-12
COMMANDS / FUNCTIONS INTABULAR FORM	13-15
ACKNOWLEDGEMENTS FROM THE CONTROL PANEL	16
PROGRAMMING EXAMPLE	17
PROGRAMMING MACROS	18-19
DIMENSIONS	20

GENERAL

The EA eDIP240-7 is the world's first display with integrated intelligence! As well as a number of built-in fonts which can be used with pixel accuracy it also features a whole range of sophisticated graphics functions. Supplied with 5V, the display is ready for operation immediately. It is controlled via one of the 3 integrated RS-232, SPI or I²C interfaces.

Graphics commands similar to high-level languages are used for programming. There is no longer any need for the time-consuming programming of character sets and graphics routines. The ease of use of this display with its touch panel reduces development time dramatically.

HARDWARE

The display is designed to work with an operating voltage of +5V. Data transfer is either serial and asynchronous using the RS-232 format or synchronous using the SPI or I²C specification. A simple protocol is used for all data transfer variants to improve data reliability.

ANALOG TOUCH PANEL

The EA eDIP240B-7LWTP and EA eDIP240J-7LWTP versions are equipped with an integrated touch panel. You can make entries and menu or bar graph settings by touching the display. The labeling of the "keys" is flexible and can also be changed during runtime (different languages, icons). The drawing of the individual "keys" and the labeling is handled by the integrated software.

LED BACKLIGHT, TYPES B AND J

All displays in blue-and-white (B) and black-and-white (J) are equipped with a modern, low power consumption LED backlight. Whereas the black&white and the amber-colored display can still be read even when the backlight is switched off completely, the blue-white display requires a minimum level of illumination to be legible. The backlight can be switched off with a software command and the brightness can be adjusted.

We recommend the black&white version for use in direct sunlight. For all other applications, we recommend the high-contrast, blue-white version.

Note that the white LED backlight is subject to aging. That means switching off or dimming backlight is a must for 24-hour-applications. Not so for the amber backlight.

SOFTWARE

The display is programmed by means of commands, such as *Draw a rectangle from (0,0) to (64,15)*. No additional software or drivers are required. Strings can be placed with **pixel accuracy**. Flashing attributes can be assigned as often as you like – for graphics as well. Text and graphics can be combined at any time. Up to 16 different character sets can be used. Each one can be zoomed from 2 to 4 times. With the largest character set, the words and numbers displayed will fill the screen.

ACCESSORIES

Evaluation-Board (Programmer) for internal data flash memory

The display is shipped fully programmed and with all fonts. The additional Evaluation-Board is thus generally not required.

However, if the internal character sets have to be changed or extended, or if images or macros have to be stored internally, the Evaluation-Board EA 9777-2USB, which is available as an accessory, will burn the data/images you have created into the on-board EEPROM (32/64 kB) permanently.

The Evaluation-Board runs under Windows and is connected to the PC's USB interface. It is shipped with an interface cable and the installation software. The Evaluation-Board is equipped with several LEDs, pushbuttons and potentiometer to test all peripheral modes of the eDIP.

Interface-Expansion for Evaluation-Board (included in the Starter-Kit):

With the expansion EA 9777-2PE for the Evaluation-Board all interfaces of the display are made available with the help from small adapter boards: RS-232, RS-485, SPI, I²C, RS-232 (CMOS level).

Further information you will find in the datasheet of the Evaluation-Board.

SPEZIFICATION AND CHARACTERISTICS

Characteristics					
Value	Condition	min.	typ.	max.	Unit
Operating Temperature		-20		+70	°C
Storage Temperature		-30		+80	°C
Storage Humidity	< 40°C			90	%RH
Operating Voltage		4.5	5.0	5.5	V
Input Low Voltage		-0.5		0.2*VDD	V
Input High Voltage	Pin Reset only	0.9*VDD		VDD+0.5	V
Input High Voltage	except Reset	0.6*VDD		VDD+0.5	V
Input Leakage Current	Pin MOSI only			1	uA
Input Pull-up Resistor		20		50	kOhms
Output Low Voltage				0.7	V
Output High Voltage		4.0			V
Output Current				20	mA
Current	Backlight off		75		mA
	Backlight on		210		mA

OUTPUT

Beginning with firmware V1.6 and the higher the EA eDIP240 is able to provide up to 7 digital output for driving an external LED for example.

Depending on the choosen interface mode RS232, SPI or I2C all non used configuration pins can be used as separate output lines. All lines used for output (open drain with internal pull-up) are like 1=HIGH level for interface mode configuration.

Each output can be set by command 'ESC YW n1 n2' individually. Maximum current is 10mA per line. Because of internal pull-up construction the max. current is valid for L level only. So theoretically each line is able drive a LED direct. Larger current need to be amplified by use of a transistor or MOSFET.

Relation Output <-> Pin No.						
Output No.	RS232/RS422		SPI		I2C	
	Pin No.	Symbol	Pin No.	Symbol	Pin No.	Symbol
OUT1	6	BAUD0	10	DORD	6	BA0
OUT2	7	BAUD1	12	OUT2	7	BA1
OUT3	8	BAUD2	13	DPOM	8	SA0
OUT4	9	ADR0	14	CPOL	9	SA1
OUT5	13	DPOM	15	CPHA	10	SA2
OUT6	14	ADR1			11	BA2
OUT7	15	ADR2			13	DPOM

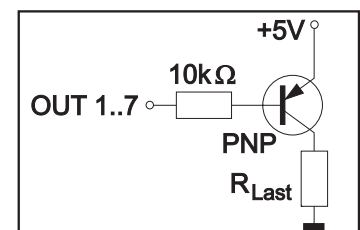

RS-232/RS-422 INTERFACE

Wiring the display as shown below selects the RS-232/RS-422 interface. The pin assignment is shown in the table on the right.

The RxD and TxD lines have a 5V CMOS line level. If “genuine” RS-232 levels are required (e.g. for direct connection to a PC), an external level converter such as the ICL232 is necessary.

Pinout eDIP240-7						
RS-232 / RS-422 mode						
Pin	Symbol	In/Out	Function	Pin	Symbol	Function
1	GND	-	Ground Potential for logic (0V)	21	N.C.	not connected
2	VDD	-	Power supply for logic (+5V)	22	N.C.	not connected
3	VADJ	In	Operating voltage for LC driving (input)	23	N.C.	not connected
4	VOUT	Out	Output voltage for LC driving	24	N.C.	not connected
5	RESET	-	L: Reset	25	N.C.	not connected
6	BAUD0	In	Baud Rate 0	26	N.C.	not connected
7	BAUD1	In	Baud Rate 1	27	N.C.	not connected
8	BAUD2	In	Baud Rate 2	28	N.C.	not connected
9	ADR0	In	Address 0 for RS-485 (V1.3 or later)	29	N.C.	not connected
10	RxD	In	Receive Data	30	N.C.	not connected
11	TxD	Out	Transmit Data	31	N.C.	not connected
12	EN485	Out	Transmit Enable for RS-485 driver	32	N.C.	not connected
13	DPOM	In	L: disable Power-On-Macro do not connect for normal operation	33	N.C.	not connected
14	ADR1	In	Address 1 for RS-485 (V1.3 or later)	34	N.C.	not connected
15	ADR2	In	Address 2 for RS-485 (V1.3 or later)	35	N.C.	not connected
16	BUZZ	Out	Buzzer output	36	N.C.	not connected
17	EEP_SDA	Bidir.	Serial Data Line for int. EEPROM	37	N.C.	not connected
18	EEP_SCL	Out	Serial Clock Line for int. EEPROM	38	N.C.	not connected
19	EEP_WP	In	H: Write Protect for int. EEPROM	39	N.C.	not connected
20	TEST SBUF	IN Out	open-drain with internal pullup 20..50k IN (Power-On) L: Testmode OUT L: data in sendbuffer	40	N.C.	not connected

Note:
At pin 20 (SBUF), the display sets a low level to indicate that data is available to be fetched from the internal send buffer. This line can, for instance, be connected to an interrupt input of the host system.

BAUDRATES

The baud rate is set with pins 6, 7 and 8 (Baud0 through 2). The data format is set permanently to 8 data bits, 1 stop bit, no parity. RTS/CTS handshaking lines are not required. The integrated software protocol takes on the necessary control functions (see pages 8 and 9).

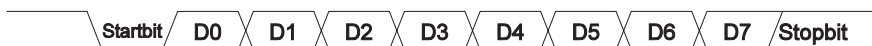

Baud rates			
Baud0	Baud1	Baud2	Data format 8,N,1
0	0	0	1200
1	0	0	2400
0	1	0	4800
1	1	0	9600
0	0	1	19200
1	0	1	38400
0	1	1	57600
1	1	1	115200

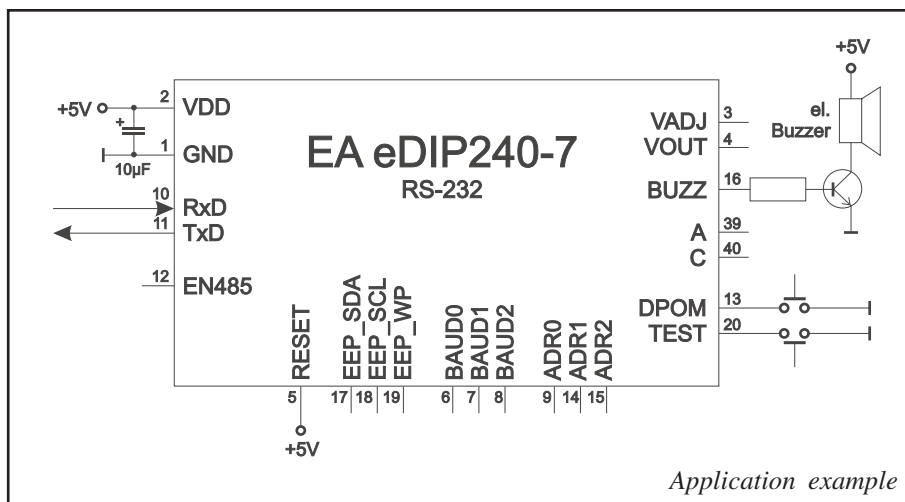

Application example

SPI INTERFACE

Wiring the display as shown below activates SPI mode. Data is then transferred over the serial, synchronous SPI interface. The DORD, CPOL and CPHA inputs are used to match the hardware conditions to the master. For example (see diagram below).

A reasonable communication is possible up to 100 kHz. Clock frequency may be raised up to 3 MHz, but in this case make shure, that there is a pause between 2 bytes of min. 100 μ s.

Note:

At pin 20 (SBUF), the display sets a low level to indicate that data is available to be fetched from the internal send buffer. This line can, for instance, be connected to an interrupt input of the host system.

Pinout eDIP240-7						
SPI mode						
Pin	Symbol	In/Out	Function	Pin	Symbol	Function
1	GND	-	Ground Potential for logic (0V)	21	N.C.	not connected
2	VDD	-	Power supply for logic (+5V)	22	N.C.	not connected
3	VADJ	In	Operating voltage for LC driving (input)	23	N.C.	not connected
4	VOU	Out	Output voltage for LC driving	24	N.C.	not connected
5	RESET	-	L: Reset	25	N.C.	not connected
6	SS	In	Slave Select	26	N.C.	not connected
7	MOSI	In	Serial In	27	N.C.	not connected
8	MISO	Out	Serial Out	28	N.C.	not connected
9	CLK	In	Shift Clock	29	N.C.	not connected
10	DORD	In	Data Order (0=MSB first; 1=LSB first)	30	N.C.	not connected
11	SPI MODE	In	connect to GND for SPI interface	31	N.C.	not connected
12	OUT2	Out	open-drain with internal pullup 20..50k (V1.6 or later)	32	N.C.	not connected
13	DPOM	In	L: disable Power-On-Macro do not connect for normal operation	33	N.C.	not connected
14	CPOL	In	Clock Polarity (0=LO 1=HI when idle)	34	N.C.	not connected
15	CPHA	In	Clock Phase (sampled on 0=1st 1=2nd edge)	35	N.C.	not connected
16	BUZZ	Out	Buzzer output	36	N.C.	not connected
17	EEP_SDA	Bidir.	Serial Data Line for int. EEPROM	37	N.C.	not connected
18	EEP_SCL	Out	Serial Clock Line for int. EEPROM	38	N.C.	not connected
19	EEP_WP	In	H: Write Protect for int. EEPROM	39	N.C.	not connected
20	TEST SBUF	IN Out	open-drain with internal pullup 20..50k IN (Power-On) L: Testmode OUT L: data in sendbuffer	40	N.C.	not connected

DATATRANSFER SPI

Via the pins DORD, CPOL and CPHA transfer parameter will be set.

Write operation: a clock rate up to 100 kHz is allowed without any stop. Together with a pause of 100 μ s between every data byte a clock rate up to 3 MHz an be reached.

Read operation: to read data (e.g. the "ACK" byte) a dummy byte (e.g. 0xFF) need to be sent. Note that the EA eDIP240-7 for internal operation does need a short time before providing the data; therefore a short pause of min. 6 μ s (no activity of CLK line) is needed for each byte. Same is with 100kHz operation.

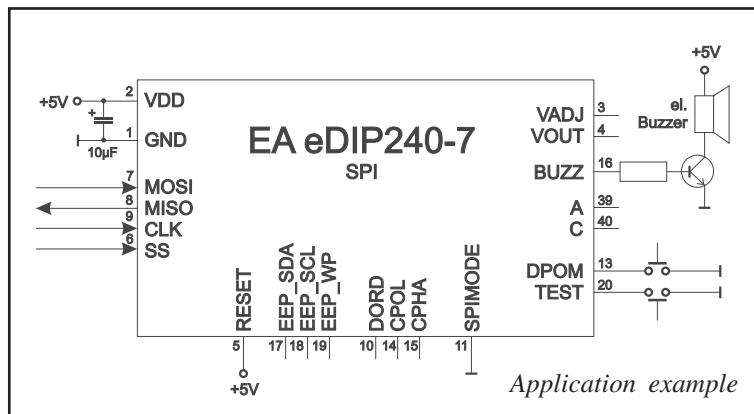
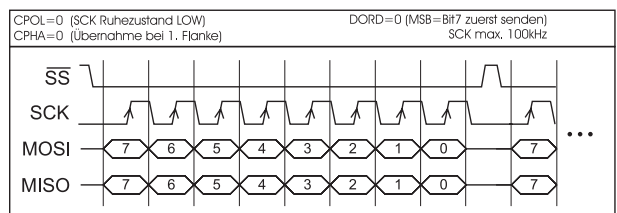
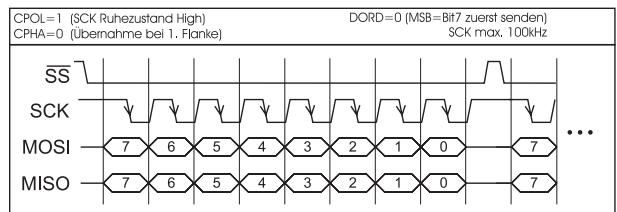
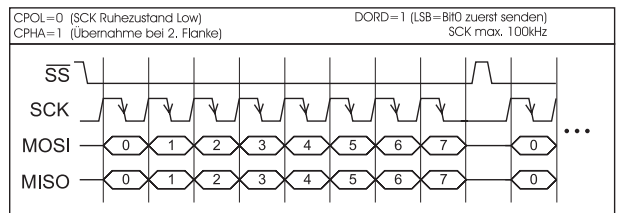
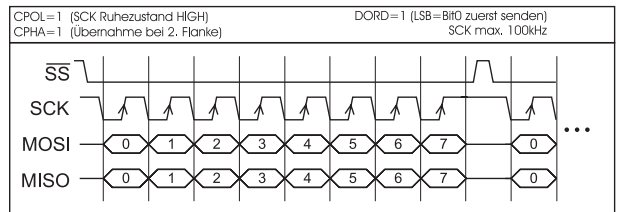

I²C BUS INTERFACE

Wiring the display as shown below allows the display to be operated directly on an I²C bus.

4 different base addresses and 8 different slave addresses can be selected at the display.

A data transmission rate of up to 100kHz is possible.

If transmitter will pause for min. 100 μs between each byte, SCL may rise up to max. 400 kHz.

Pinout eDIP240-7						
I ² C-Bus mode						
Pin	Symbol	In/Out	Function	Pin	Symbol	Function
1	GND	-	Ground Potential for logic (0V)	21	N.C.	not connected
2	VDD	-	Power supply for logic (+5V)	22	N.C.	not connected
3	VADJ	In	Operating voltage for LC driving (input)	23	N.C.	not connected
4	VOUT	Out	Output voltage for LC driving	24	N.C.	not connected
5	RESET	-	L: Reset	25	N.C.	not connected
6	BA0	In	Basic Address 0	26	N.C.	not connected
7	BA1	In	Basic Address 1	27	N.C.	not connected
8	SA0	In	Slave Address 0	28	N.C.	not connected
9	SA1	In	Slave Address 1	29	N.C.	not connected
10	SA2	In	Slave Address 2	30	N.C.	not connected
11	BA2	In	Basic Address 2 (V1.3 or later)	31	N.C.	not connected
12	I ² C MODE	In	connect to GND for I ² C interface	32	N.C.	not connected
13	DPOM	In	L: disable Power-On-Macro do not connect for normal operation	33	N.C.	not connected
14	SDA	Bidir.	Serial Data Line	34	N.C.	not connected
15	SCL	In	Serial Clock Line	35	N.C.	not connected
16	BUZZ	Out	Buzzer output	36	N.C.	not connected
17	EEP_SDA	Bidir.	Serial Data Line for int. EEPROM	37	N.C.	not connected
18	EEP_SCL	Out	Serial Clock Line for int. EEPROM	38	N.C.	not connected
19	EEP_WP	In	H: Write Protect for int. EEPROM	39	N.C.	not connected
20	TEST SBUF	IN Out	open-drain with internal pullup 20..50k IN (Power-On) L: Testmode OUT L: data in sendbuffer	40	N.C.	not connected

Note:

At pin 20 (SBUF), the display sets a low level to indicate that data is available to be fetched from the internal send buffer. This line can, for instance, be connected to an interrupt input of the host system.

Note:

The pins BA0 to 2, SA0 to 2, DPOM, DPROT and TEST/SBUF have an internal pullup, which is why only the LO level (L=0=GND) is to be actively applied. These pins must be left open for a Hi level (H=1). On pin 20 (SBUF) the display indicates with a low level that data is ready to be retrieved from the internal send buffer. The line can be connected to an interrupt input of the host system, for example.

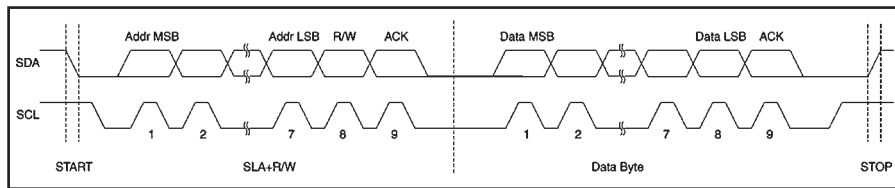

Pin 11,7,6		Base address	I ² C address								
BA2	BA1	BA0	D7	D6	D5	D4	D3	D2	D1	D0	
L	L	L	\$10	0	0	0	1	S A 2	S A 1	S A 0	R W
L	L	H	\$20	0	0	1	0				
L	H	L	\$30	0	0	1	1				
L	H	H	\$40	0	1	0	0				
H	L	L	\$70	0	1	1	1				
H	L	H	\$90	1	0	0	1				
H	H	L	\$B0	1	0	1	1				
H	H	H	\$D0	1	1	0	1				

all pins open: Write \$DE
Read \$DF

DATA TRANSFER I²C-BUS

principle I²C-bus transfer:

- I²C-Start
- Master-Transmit: EA eDIP-I²C-address (e.g. \$DE), send smallprotocol package (data)
- I²C-Stop
- I²C-Start
- Master-Read: EA eDIP-I²C-Address (e.g. \$DF), read ACK-byte and opt. smallprotocol package (data)
- I²C-Stop

Read operation: for internal operation the EA eDIP240-7 does need a short time before providing the data; therefore a short pause of min. 6μs is needed for each byte (no activity of SCL line).

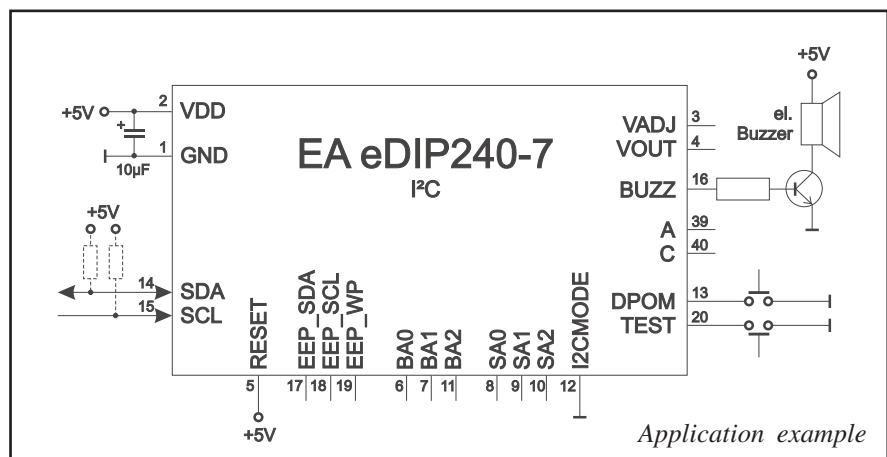

Application example

DATATRANSFER PROTOCOL (SMALL PROTOCOL)

The protocol has an identical structure for all 3 interface types: RS-232, SPI and I²C. Each data transfer is embedded in a fixed frame with a checksum (protocol package). The EA eDIP240-7 acknowledges this package with the character <ACK> (= \$06) on successful receipt or <NAK> (= \$15) in the event of an incorrect checksum or receive buffer overflow. In the case of <NAK>, the entire package is rejected and must be sent again.

Receiving the <ACK> byte means only that the protocol package is ok, there is no syntax check for the command.

Note: it is necessary to read the <ACK> byte in any case.

If the host computer does not receive an acknowledgment, at least one byte is lost. In this case, the set timeout has to elapse before the package is sent again.

The raw data volume per package is limited to 64 bytes (len ≤ 64). Commands longer than 64 bytes (e.g. Load image ESC UL...) must be divided up between a number of packages. All data in the packages are compiled again after being correctly received by the EA eDIP240-7.

DEACTIVATING THE SMALL PROTOCOL

For tests the protocol can be deactivated by closing the solder strap J2 (see page 20). In normal operation, however, you are urgently advised to activate the protocol. If you do not, any overflow of the receive buffer will not be detected.

BUILDING THE SMALL PROTOCOL PACKAGES

Command/Data to the display

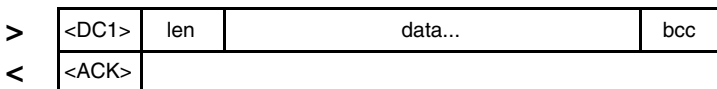

<DC1> = 17(dec.) = \$11 <ACK> = 6(dec.) = \$06
 len = count of user data (without <DC1>, without checksum bcc)
 bcc = 1 byte = sum of all bytes incl. <DC1> and len, modulo 256

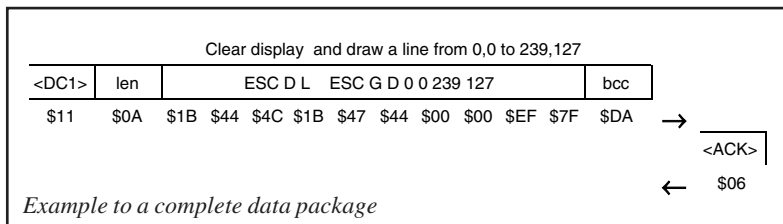

Request for content of send buffer

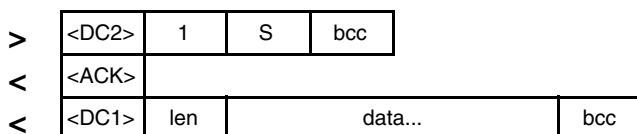

<DC2> = 18(dec.) = \$12 1 = 1(dec.) = \$01 S = 83(dec.) = \$53
 <ACK> = 6(dec.) = \$06
 len = count of user data (without <DC2>, without checksum bcc)
 bcc = 1 byte = sum of all bytes incl. <DC2>, modulo 256

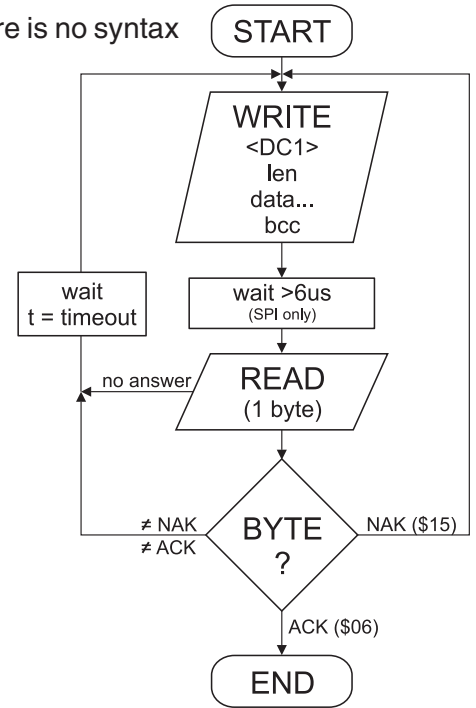

The user data is transferred framed by <DC1>, the number of bytes (len) and the checksum (bcc). The display responds with <ACK>.

```
void sendData(unsigned char *buf, unsigned char len)
{
    unsigned char i, bcc;

    SendByte(0x11);           // Send DC1
    bcc = 0x11;

    SendByte(len);           // Send data length
    bcc = bcc + len;

    for(i=0; i < len; i++)    // Send buf
    { SendByte(buf[i]);
      bcc = bcc + buf[i];
    }

    SendByte(bcc);           // Send checksum
}

// „C“ source code to transmit a data package
```

The command sequence <DC2>, 1, S, bcc empties the display's send buffer. The display replies with the acknowledgement <ACK> and then begins to send all the collected data such as touch keystrokes.

Request for buffer information

>	<DC2>	1	I	bcc	
<	<ACK>				
<	<DC2>	2	send buffer bytes ready	receive buffer bytes free	bcc

<DC2> = 18(dec.) = \$12 I = 1(dez.) = \$01 I = 73(dez.) = \$49
 <ACK> = 6(dec.) = \$06
 send buffer bytes ready = count of bytes stored in send buffer
 receive buffer bytes free = count of bytes for free receive buffer
 bcc = 1 byte = sum of all bytes incl. <DC2>, modulo 256

This command queries whether user data is ready to be picked up and how full the display's receive buffer is.

Protocol settings

>	<DC2>	3	D	packet size for send buffer	timeout	bcc
<	<ACK>					

<DC2> = 18(dec.) = \$12 3 = 3(dez.) = \$03 D = 68(dez.) = \$44
 packet size for send buffer = 1..64 (standard: 64)
 timeout = 1..255 in 1/100 seconds (standard: 200 = 2 seconds)
 bcc = 1 byte = sum of all bytes incl. <DC2>, modulo 256
 <ACK> = 6(dec.) = \$06

This is how the maximum package size that can be sent by the display can be limited. The default setting is a package size with up to 64 bytes of user data.

The timeout can be set in increments of 1/100 seconds. The timeout is activated when individual bytes get lost. The entire package then has to be sent again.

Request for protocol settings

>	<DC2>	1	P	bcc		
<	<ACK>					
<	<DC2>	3	max. packet size	akt. send packet size	akt. timeout	bcc

<DC2> = 18(dec.) = \$12 I = 1(dez.) = \$01 P = 80(dez.) = \$50
 <ACK> = 6(dec.) = \$06
 max. packet size = count of maximum user data for 1 package (eDIP240-7 = 64)
 akt. send packet size = current package size for send
 akt. timeout = current timeout in 1/100 seconds
 bcc = 1 byte = sum of all bytes incl. <DC2>, modulo 256

This command is used to query protocol settings.

Repeat the last package

>	<DC2>	1	R	bcc
<	<ACK>			
<	<DC1>	len	data...	bcc

<DC2> = 18(dec.) = \$12 I = 1(dez.) = \$01 R = 82(dez.) = \$52
 <ACK> = 6(dec.) = \$06
 <DC1> = 17(dec.) = \$11
 len = count of user data in byte (without checksum, without <DC1> or <DC2>)
 bcc = 1 byte = sum of all bytes incl. <DC2> and len, modulo 256

If the most recently requested package contains an incorrect checksum, the entire package can be requested again. The reply can then be the contents of the send buffer (<DC1>) or the buffer/protocol information (<DC2>).

Addressing (only for RS232/RS485)

>	<DC2>	3	A	select or deselect	adr	bcc
<	<ACK>					

<DC2> = 18(dec.) = \$12 3 = 3(dez.) = \$03 A = 65(dez.) = \$41
 select or deselect: 'S' = \$53 or 'D' = \$44
 adr = 0..255
 bcc = 1 byte = sum of all bytes incl. <DC2> and adr, modulo 256
 <ACK> = 6(dec.) = \$06

This command can be used to select or deselect the eDIP with the address adr.

TOUCH PANEL (EAeDIP240x-7LWTP only)

The versions -7xxTP are supplied with an analog resistive touch panel. Up to 60 touch regions (buttons, switches, menus, bar graph entries), can be defined simultaneously. The fields can be defined to single-pixel accuracy. The display supports representation using easy-to-use commands (see page 15). When the touch “keys” are touched, they can be automatically inverted and an external buzzer (pin 16) can sound, indicating they have been touched. The defined return code of the “key” is transmitted via the serial interface, or an internal touch macro with the number of the return code is started (see page 18, *Macro programming*).

TOUCH PANEL ADJUSTMENT

The touch panel is perfectly adjusted and immediately ready for operation on delivery. As a result of aging and wear, it may become necessary to readjust the touch panel.

Adjustment procedure:

1. Touch the touch panel at power-on and keep touching it. After the message “touch adjustment ?” appears, release the touch panel again (or issue the ‘ESC @’ command).
2. Touch the touch panel again within a second for at least a second.
3. Follow the instructions for adjustment (press the 2 points upper left and lower right).

FRAMES AND KEY FORMS

A frame type can be set by using the *Draw frame* or *Draw frame box* command or by drawing touch keys. 18 frame types are available (0= do not draw a frame).

BITMAPS AS KEYS

In addition to the frame types, which can be scaled to any size, you also have the option of using any bitmap images (in each case, a pair showing the *not pressed* and *pressed* statuses) as touch keys or switches.

The LCD-Tools^{*)} allows you to incorporate your own buttons in the form of images (compiler statement “PICTURE”). A button always comprises two monochrome

Windows BMPs of the same size (one bitmap showing the normal representation of the touch key and one showing the pressed touch key). The active area of the touch key is derived automatically from the size of the button bitmaps.



SWITCHES IN GROUPS (RADIO GROUP)

Touch switches change their status from *ON* to *OFF* and vice versa each time they are touched. A number of touch switches can be grouped together (command: ‘ESC A R nr’). If a touch switch in an ‘nr’ group is now switched on, all other buttons in this group are automatically switched off. This means that one button is only ever on at a time.

^{*)} see our web site at <http://www.lcd-module.de/deu/touch/touch.htm>

INTEGRATED AND EXTERNAL FONTS

Apart from the 8x8 terminal font (font no. 8), 3 additional monospaced fonts, 3 proportional fonts and 1 large numeric font are integrated as standard. The proportional fonts result in a more attractive appearance, and at the same time require less space on screen (e.g. the "i" is narrow and the "W" is wide). Each character can be positioned **with pixel accuracy** and the width and height can be scaled by a factor of 1 - 4.

Each text can be output left justified, right justified or centered. 90° rotation e.g. for vertical installation of the display is also possible. Macro programming permits additional fonts to be integrated (up to 15). This is done with a text editor and programmed using the LCD-Tools* (EA 9777-1USB).

+ Lower Upper	\$0 (0)	\$1 (1)	\$2 (2)	\$3 (3)	\$4 (4)	\$5 (5)	\$6 (6)	\$7 (7)	\$8 (8)	\$9 (9)	\$A (10)	\$B (11)	\$C (12)	\$D (13)	\$E (14)	\$F (15)
\$20 (dez: 32)		!	"	#	\$	%	&	'	()	*	+	,	-	.	/
\$30 (dez: 48)	0	1	2	3	4	5	6	7	8	9	:	;	<	=	>	?
\$40 (dez: 64)	@	A	B	C	D	E	F	G	H	I	J	K	L	M	N	O
\$50 (dez: 80)	P	Q	R	S	T	U	V	W	X	Y	Z	[\]	^	_
\$60 (dez: 96)	`	a	b	c	d	e	f	g	h	i	j	k	l	m	n	o
\$70 (dez: 112)	p	q	r	s	t	u	v	w	x	y	z	{		}	~	Δ
\$80 (dez: 128)	€	ü	é	â	ä	à	ç	ê	ë	è	ï	î	ì	ñ	ř	
\$90 (dez: 144)	É	æ	Æ	ô	ö	ò	û	ü	ÿ	ö	Ü	†	‡	¥	ß	ƒ
\$A0 (dez: 160)	á	í	ó	ú	ñ	ñ	ã	ø	¿	¡	¼	½	¾	¿	«	»
\$B0 (dez: 176)																
\$C0 (dez: 192)																
\$D0 (dez: 208)																
\$E0 (dez: 224)	α	β	Γ	π	Σ	σ	μ	τ	ξ	θ	η	δ	ψ	φ	ε	π
\$F0 (dez: 240)	≡	±	≥	≤	Γ	J	÷	≈	°	•	•	•	•	•	•	•

Font 1: 4x6 monospaced

+ Lower Upper	\$0 (0)	\$1 (1)	\$2 (2)	\$3 (3)	\$4 (4)	\$5 (5)	\$6 (6)	\$7 (7)	\$8 (8)	\$9 (9)	\$A (10)	\$B (11)	\$C (12)	\$D (13)	\$E (14)	\$F (15)
\$20 (dez: 32)		!	"	#	\$	%	&	'	()	*	+	,	-	.	/
\$30 (dez: 48)	0	1	2	3	4	5	6	7	8	9	:	;	<	=	>	?
\$40 (dez: 64)	@	A	B	C	D	E	F	G	H	I	J	K	L	M	N	O
\$50 (dez: 80)	P	Q	R	S	T	U	V	W	X	Y	Z	[\]	^	_
\$60 (dez: 96)	`	a	b	c	d	e	f	g	h	i	j	k	l	m	n	o
\$70 (dez: 112)	p	q	r	s	t	u	v	w	x	y	z	{		}	~	Δ
\$80 (dez: 128)	€	ü	é	â	ä	à	ç	ê	ë	è	ï	î	ì	ñ	ř	
\$90 (dez: 144)	É	æ	Æ	ô	ö	ò	û	ü	ÿ	ö	Ü	†	‡	¥	ß	ƒ
\$A0 (dez: 160)	á	í	ó	ú	ñ	ñ	ã	ø	¿	¡	¼	½	¾	¿	«	»
\$B0 (dez: 176)																
\$C0 (dez: 192)																
\$D0 (dez: 208)																
\$E0 (dez: 224)	α	β	Γ	π	Σ	σ	μ	τ	ξ	θ	η	δ	ψ	φ	ε	π
\$F0 (dez: 240)	≡	±	≥	≤	Γ	J	÷	≈	°	•	•	•	•	•	•	•

Font 2: 6x8 monospaced

+ Lower Upper	\$0 (0)	\$1 (1)	\$2 (2)	\$3 (3)	\$4 (4)	\$5 (5)	\$6 (6)	\$7 (7)	\$8 (8)	\$9 (9)	\$A (10)	\$B (11)	\$C (12)	\$D (13)	\$E (14)	\$F (15)
\$20 (dez: 32)		!	"	#	\$	%	&	'	()	*	+	,	-	.	/
\$30 (dez: 48)	0	1	2	3	4	5	6	7	8	9	:	;	<	=	>	?
\$40 (dez: 64)	@	A	B	C	D	E	F	G	H	I	J	K	L	M	N	O
\$50 (dez: 80)	P	Q	R	S	T	U	V	W	X	Y	Z	[\]	^	_
\$60 (dez: 96)	`	a	b	c	d	e	f	g	h	i	j	k	l	m	n	o
\$70 (dez: 112)	p	q	r	s	t	u	v	w	x	y	z	{		}	~	Δ
\$80 (dez: 128)	€	ü	é	â	ä	à	ç	ê	ë	è	ï	î	ì	ñ	ř	
\$90 (dez: 144)	É	æ	Æ	ô	ö	ò	û	ü	ÿ	ö	Ü	†	‡	¥	ß	ƒ
\$A0 (dez: 160)	á	í	ó	ú	ñ	ñ	ã	ø	¿	¡	¼	½	¾	¿	«	»
\$B0 (dez: 176)																
\$C0 (dez: 192)																
\$D0 (dez: 208)																
\$E0 (dez: 224)	α	β	Γ	π	Σ	σ	μ	τ	ξ	θ	η	δ	ψ	φ	ε	π
\$F0 (dez: 240)	≡	±	≥	≤	Γ	J	÷	≈	°	•	•	•	•	•	•	•

Font 3: 7x12 monospaced

+ Lower Upper	\$0 (0)	\$1 (1)	\$2 (2)	\$3 (3)	\$4 (4)	\$5 (5)	\$6 (6)	\$7 (7)	\$8 (8)	\$9 (9)	\$A (10)	\$B (11)	\$C (12)	\$D (13)	\$E (14)	\$F (15)
\$20 (dez: 32)		!	"	#	\$	%	&	'	()	*	+	,	-	.	/
\$30 (dez: 48)	0	1	2	3	4	5	6	7	8	9	:	;	<	=	>	?
\$40 (dez: 64)	@	A	B	C	D	E	F	G	H	I	J	K	L	M	N	O
\$50 (dez: 80)	P	Q	R	S	T	U	V	W	X	Y	Z	[\]	^	_
\$60 (dez: 96)	`	a	b	c	d	e	f	g	h	i	j	k	l	m	n	o
\$70 (dez: 112)	p	q	r	s	t	u	v	w	x	y	z	{		}	~	Δ
\$80 (dez: 128)	€	ü	é	â	ä	à	ç	ê	ë	è	ï	î	ì	ñ	ř	
\$90 (dez: 144)	É	æ	Æ	ô	ö	ò	û	ü	ÿ	ö	Ü	†	‡	¥	ß	ƒ
\$A0 (dez: 160)	á	í	ó	ú	ñ	ñ	ã	ø	¿	¡	¼	½	¾	¿	«	»
\$B0 (dez: 176)																
\$C0 (dez: 192)																
\$D0 (dez: 208)																
\$E0 (dez: 224)	α	β	Γ	π	Σ	σ	μ	τ	ξ	θ	η	δ	ψ	φ	ε	π
\$F0 (dez: 240)	≡	±	≥	≤	Γ	J	÷	≈	°	•	•	•	•	•	•	•

Font 4: GENEVA10 proportional

+ Lower Upper	\$0 (0)	\$1 (1)	\$2 (2)	\$3 (3)	\$4 (4)	\$5 (5)	\$6 (6)	\$7 (7)	\$8 (8)	\$9 (9)	\$A (10)	\$B (11)	\$C (12)	\$D (13)	\$E (14)	\$F (15)
\$20 (dez: 32)		!	"	#	\$	%	&	'	()	*	+	,	-	.	/	
\$30 (dez: 48)	0	1	2	3	4	5	6	7	8	9	:	;	<	=	>	?
\$40 (dez: 64)	@	A	B	C	D	E	F	G	H	I	J	K	L	M	N	O
\$50 (dez: 80)	P	Q	R	S	T	U	V	W	X	Y	Z	[\]	^	_		
\$60 (dez: 96)	`	a	b	c	d	e	f	g	h	i	j	k	l	m	n	o
\$70 (dez: 112)	p	q	r	s	t	u	v	w	x	y	z	{ }	~	Δ		
\$80 (dez: 128)	€	ü	é	â	ä	à	å	ç	ê	ë	è	ï	î	ì	ñ	Å
\$90 (dez: 144)	É	æ	Æ	ô	ö	ò	û	ù	ÿ	ö	ü					
\$A0 (dez: 160)	á	í	ó	ú	ñ	Ñ	ä	ö								
\$B0 (dez: 176)																
\$C0 (dez: 192)																
\$D0 (dez: 208)																
\$E0 (dez: 224)		ß														
\$F0 (dez: 240)								°								

Font 5: CHICAGO14 proportional

+ Lower Upper	\$0 (0)	\$1 (1)	\$2 (2)	\$3 (3)	\$4 (4)	\$5 (5)	\$6 (6)	\$7 (7)	\$8 (8)	\$9 (9)	\$A (10)	\$B (11)	\$C (12)	\$D (13)	\$E (14)	\$F (15)
\$20 (dez: 32)		!	"	#	\$	%	&	'	()	*	+	,	-	.	/	
\$30 (dez: 48)	0	1	2	3	4	5	6	7	8	9	:	;	<	=	>	?
\$40 (dez: 64)	@	A	B	C	D	E	F	G	H	I	J	K	L	M	N	O
\$50 (dez: 80)	P	Q	R	S	T	U	V	W	X	Y	Z	[\]	^	_		
\$60 (dez: 96)	`	a	b	c	d	e	f	g	h	i	j	k	l	m	n	o
\$70 (dez: 112)	p	q	r	s	t	u	v	w	x	y	z	{ }	~	Δ		
\$80 (dez: 128)	€	ü	é	â	ä	à	å	ç	ê	ë	è	ï	î	ì	ñ	Å
\$90 (dez: 144)	É	æ	Æ	ô	ö	ò	û	ù	ÿ	ö	ü					
\$A0 (dez: 160)	á	í	ó	ú	ñ	Ñ	ä	ö								
\$B0 (dez: 176)																
\$C0 (dez: 192)																
\$D0 (dez: 208)																
\$E0 (dez: 224)		ß														
\$F0 (dez: 240)								°								

Font 6: Swiss30 Bold proportional

+ Lower Upper	\$0 (0)	\$1 (1)	\$2 (2)	\$3 (3)	\$4 (4)	\$5 (5)	\$6 (6)	\$7 (7)	\$8 (8)	\$9 (9)	\$A (10)	\$B (11)	\$C (12)	\$D (13)	\$E (14)	\$F (15)
\$20 (dez: 32)												+	,	-	.	
\$30 (dez: 48)	0	1	2	3	4	5	6	7	8	9	:					

Font 7: big numbers BigZif57

TYPEFACE

This picture of a screen image shows all the integrated standard fonts.

Macro programming permits some additional fonts to be integrated. Any conceivable font (including Chinese or Cyrillic) can be created with a text editor and programmed using the LCD-Toolkit*) and programmer EA 9777-1USB.



*) see our web site at <http://www.lcd-module.de/deu/touch/touch.htm>

ALL COMMANDS AT A GLANCE

The built-in intelligence allows an easy creation of your individual screen content. Below mentioned commands can be used either directly via the serial interface (see page 17) or together with the self-definable macro (see page 18).

EA eDIP240-7: Command table 1							after reset	
Command	Codes			Remarks				
Commands for terminal mode								
Formfeed FF (dez:12)	^L					The contents of the terminal area are deleted and the cursor is placed at pos. (1,1)		
Carriage Return CR(13)	^M					Cursor to the beginning of the line on the extreme left		
Linefeed LF (dez:10)	^J					Cursor is set to the next line		
Cursor position	ESC	T	P	n1	n2	n1=column; n2=line; origin upper-left corner (1,1)	1,1	
Cursor On / Off			C	n1		n1=0: Cursor is invisible; n1=1: Cursor flashes;	1	
Terminal invisible			A			Terminal display not visible; outputs are ignored		
Terminal visible			E			Terminal display is visible again;	visibl	
Show revision code			V			Show revision code on terminal layer e.g. "EA eDIP240-7 V1.1 Rev.B"		
Comands for outputting strings								
Output string L: left justified C: centered R: right justified	ESC	Z	L	x1	y1	Text NUL ...	A string (...) is output to xx1,yy1. 'NUL' (\$00), 'LF' (\$0A) or 'CR' (\$0D) = end of string; several lines are separated by the character ' ' (\$7C); text between two '-' (\$7E) characters flashes on/off; text between two '@' (\$40) characters flashes inversely;	
Set font			F	n1			Set font with the number n1 (0..16)	0
Font zoom factor			Z	n1	n2		n1 = X zoom factor (1x..4x); n2 = Y zoom factor (1x..4x)	1,1
Add. line spacing			Y	n1			Insert n1 pixels between two lines of text as additional line spacing	
Text angle			W	n1			Text output angle: n1=0: 0°; n1=1: 90°	0
Text mode			V	n1			Set mode n1: 1=set; 2=delete; 3=inverse; 4=replace; 5=inverse replace;	4
Text blink attribute			B	n1			n1: 0=text solid, blink off; 1=text blink on/off; 2=text blink inverted;	0
String for terminal			ESC	Z	T		Text ...	Command for outputting a string in a macro to the terminal
Draw straight lines and points								
Draw rectangle	ESC	G	R	x1	y1	x2 y2	Draw four straight lines as a rectangle from x1,y1 to x2,y2	
Draw straight line			D	x1	y1	x2 y2	Draw straight line from x1,y1 to x2,y2	
Continue straight line			W	x1	y1		Draw a straight line from last end point to x1, y1	0
Draw point			P	x1	y1		Set one dot at coordinates x1, y1	
Point size/line thickness			Z	n1	n2		n1 = X-Punktgröße (1..15); n2 = Y-Punktgröße (1..15);	1,1
Graphic mode			V	n1			Drawing mode n1: 1=set; 2=delete; 3=inverse;	1
Change/draw rectangular areas								
Delete area	ESC	R	L	x1	y1	x2 y2	Delete an area from x1,y1 to x2,y2 (all pixels out)	
Invert area			I	x1	y1	x2 y2	Invert an area from x1,y1 to x2,y2 (invert all pixels)	
Fill area			S	x1	y1	x2 y2	Fill an area from x1,y1 to x2,y2 (all pixels on)	
Area with fill pattern			M	x1	y1	x2 y2 n1	Draw an area from x1,y1 to x2,y2 with pattern n1 (always set)	
Draw box			O	x1	y1	x2 y2 n1	Draw a rectangle x1,y1 to x2,y2 with fill pattern n1 (always replace)	
Draw frame			R	x1	y1	x2 y2 n1	Draw a frame of the type n1 from x1,y1 to x2,y2 (always set)	
Draw frame box			T	x1	y1	x2 y2 n1	Draw a frame box of the type n1 from x1,y1 to x2,y2 (always replace)	
Bitmap image commands								
Image from clipboard	ESC	U	C	x1	y1		The current contents of the clipboard are loaded to x1,y1 with all the image attributes	
Load internal image			I	x1	y1	no	Load internal image with the no. (0..255) from EEPROM to x1,y1	
Load image			L	x1	y1	BLH data ...	Load an image to x1,y1; see image structure for image data	
Image zoom factor			Z	n1	n2		n1 = X zoom factor (1x..4x); n2 = Y zoom factor (1x..4x)	1,1
Image angle			W	n1			Output angle: n1=0: 0°; n1=1: 90°; n1=2: 180°; n1=3: 270°	0
Image link mode			V	n1			Mode n1: 1=set; 2=delete; 3=inverse; 4=replace; 5=inverse replace	4
Image flashing attribute			B	n1			n1=0 Image attribute blink off; n1=1 image blink mode on/off; n1=2 image blink mode inverse	0
Send hard copy			H	x1	y1	x2 y2	A full image is requested in Windows BMP format. The image header is sent first via RS232, followed by the actual image data (9662 bytes).	
Display commands (effect on the entire display)								
Delete display	ESC	D	L				Delete display contents (all pixels off)	
Invert display			I				Invert display contents (invert all pixels)	
Fill display			S				Fill display contents (all pixels on)	
Switch display off			A				Display contents become invisible but are retained, commands continue to be possible	
Switch display on			E				Display contents become visible again	visibl
Show clip-board			C				Show content of clip-board. Standard display output is no longer visible	
Show current			N				Switch back to noraml operation. Standard display output is visible	
Flashing area commands								
Delete flashing attribute	ESC	Q	L	x1	y1	x2 y2	Delete the flashing attribute from x1,y1 to x2,y2	
Inverted flashing area			I	x1	y1	x2 y2	Define an inverted flashing area from x1,y1 to x2,y2	
Pattern for flashing area			M	x1	y1	x2 y2 n1	Define flashing area with pattern n1 (on/off) from x1,y1 to x2,y2	
Set flashing time			Z	n1			Set the flashing time n1= 1..15 in 1/10s; 0=deactivate flashing function	6

EA eDIP240-7: Command table 2

Command	Codes		Remarks								after reset			
Bar graph commands														
Define bar graph			R L O U	n1	x1	y1	x2	y2	sv	ev	type	pat	Define bar graph to L(left), R(right), O(ben) (up), U(nten) (down) with the "nr" (1..32). x1,y1,x2,y2 form the rectangle enclosing the bar graph. sv, ev are the values for 0% and 100%. type=0: bar; type=1: bar in rectangle; pat=bar pattern type=2: line; type=3: line in rectangle; pat= line width	No bar define
Update bar graph	ESC	B	A	n1	valu								Set and draw the bar graph with the number n1 to the new user "value."	
Draw new bar graph			Z	n1									Draw the bar graph with the number n1 completely	
Send bar graph value			S	n1									Send the current value of bar graph no. n1 on the serial interface	
Delete bar graph			D	n1	n2								Makes definition of bar graph with number n1 invalid. If bar graph was defined as a touch field, active area will become inactive again n2=0: above function and bar graph keeps visible; n2=1: bar graph will be cleared	
Clipboard commands (buffer for image areas)														
Save display contents			B										The entire contents of the display are copied to the clipboard as an image area	
Save area	ESC	C	S	x1	y1	x2	y2						The image area from x1,y1 to x2,y2 is copied to the clipboard	
Restore area			R										The image area on the clipboard is copied back its original position in the display	
Copy area			K	x1	y1								The image area on the clipboard is copied to x1,y1 in the display	
Settings for menu/pop-up and touch panel														
Set font for menu			F	n1									All following menu entries will be written in font n1 (0..16)	0
Set zoom factor			Z	n1	n2								n1 = X-zoom factor (1x..4x); n2 = Y-zoom factor (1x..4x)	1,1
add. line spacing			Y	n1									Add n1 dots as additional line spacing between 2 lines	
Angle for menu	ESC	N	W	n1									Pop-up direction: n1=0: 0°; n1=1: 90°;	0
Set automatic function for touch			T	n1									n1=1: touch menu will pop-up automatically; n1=0: touch menu will not pop-up but 'ESC T 0' will be sent to host; this one is able to pop-up with command 'ESC N T 2' then.	1
Menu/pop-up commands (not valid for touch panel use; for that see table "Commands for the touch panel")														
Define menu and show			D	x1	y1	no	text ...	NUL					A menu is drawn as of the corner x1,y1 with the current menu font. no= currently inverted entry (e.g.: 1 = 1st. entry) text:= string with menu items. The different items are separated by the character ' ' (\$7C,dec:124) (e.g. "item1 item2 item3"). The background of the menu is saved automatically. If a menu is already defined, it is automatically canceled+deleted.	
Next item	ESC	N	N										The next item is inverted or remains at the end	
Previous item			P										The previous item is inverted or remains at the beginning	
End of menu/send			S										The menu is removed from the display and replaced with the original background. The current item is sent as a number (1..n) (0=no menu displayed)	
End of menu/macro			M	n1									The menu is removed from the display and replaced with the original background. Menu macro n1 is called for item 1, menu macro nr+1 for entry 2, and so on	
End of menu/cancel			A										The menu is removed from the display and replaced with the original background	
Macro commands														
Run macro	ESC	M	N	n1									Call the (normal) macro with the number n1 (0..255) (max. 7 levels)	
Run touch macros			T	n1									Call the touch macro with the number n1 (0..255) (max. 7 levels)	
Run menu macro			M	n1									Call the menu macro with the number n1 (0..255) (max. 7 levels)	
Automatic/cyclic macro														
Macro with delay			G	n1	ts								(normal-) macro n1 (0..255) runs after delay of ts/10s. May be stopped/prevented by any command via serial interface or by touch panel	
Autom. macro cyclical, once	ESC	M	E	n1	n2	ts							Automatically macros n1..n2 once only; ts=pause in 1/10s. Will be stopped by any command via serial interface or by touch panel use	
Autom. macro cyclical			A	n1	n2	ts							Automatically macros n1..n2 cyclically; ts=pause in 1/10s. Will be stopped by any command via serial interface or by touch panel use	
Autom. macro pingpong			J	n1	n2	ts							Automatically macros n1..n2..n1 (pingpong); ts=pause in 1/10s. Will be stopped by any command via serial interface or by touch panel use	
Process macro commands (from V1.1)														
Define process macro			D	no	type	n3	n4	ts					Define process macro number no (1..4) (1=highest priority). (normal-) macro n3..n4 will be served with ts/10s delay. type: 1=once only; 2=cyclical; 3=pingpong n3..n4..n3	
Process macro speed	ESC	M	Z	no	ts								Assign a new delay for process no (1..4) with ts /10s value. ts=0 will stop the automatic	
Stop process macro			S	n1									All process macro will be stopped with n1=0 and continued with n1=1 e.g. to make settings or output via serial interface without interference	1
Other commands														
Wait (pause)	ESC	X	ts										Wait ts tenths of a second before the next command is executed.	
Beep on/off			S	ts									Switch beeper output (pin 16) ts=2..255 for ts 1/10s to high ts=0 set permanent low, ts=1 set permanent high	OFF
Backlight on/off	ESC	Y	L	ts									LED backlight n1=0: OFF; n1=1: ON; ts=2..255: switches backlight on for ts /10s and then off	1
Backlight brightness			H	n1									Adjust brightness of backlight n1=0..100% (non linear)	100
Send bytes			B	cnt	data ...								cnt (=1..255) bytes are sent via serial interface data ... = cnt. bytes (e.g. control of an external printer)	
Send version	ESC	S	V										Software version will be sent as a string ;e.g. "EA eDIP240-7 V1.2 Rev.B"	
Send version			I										(V1.3) eDIP sends internal information	

EA eDIP240-7: Commands for the touch panel											after reset			
Command	Codes		Remarks											
Touch: Define areas														
Define touch key (key remains depressed as long as there is contact)	ESC	A	T	x1	y1	x2	y2	dow code	up code	text ...	NUL	'T': The area from xx1,yy1 to xx2,yy2 is defined as a key. 'U': Image no=1..255 is loaded to xx1,yy2 and defined as a key. 'down code':(1-255) Return/touch macro when key pressed. 'up code': (1-255) Return/touch macro when key released. (down/up code = 0 press/release not reported). 'text': A string that is centered with the current touch font in the touch key follows; the first character determines the alignment of the text (C=centered, L=left, R=right justified); multiline text is separated with the character ' ' (\$7C, dec: 124); 'NUL': (\$00) = end of string		
			U	x1	y1	n1	dow code	up code	text ...	NUL				
Define touch switch (status of the switch toggles after each contact on/off)	ESC	A	K	x1	y1	x2	y2	dow code	up code	text ...	NUL	'K': The area from xx1,yy1 to xx2,yy2 is defined as a switch. 'J': Image no. n1 is loaded to xx1,yy2 and defined as a switch. 'down code': (1-255) Return/touch macro when switched on. 'up code': (1-255) Return/touch macro when switched off. (down/up code = 0 on/off not reported). 'text': A string that is centered with the current touch font in the touch key follows; the first character determines the alignment of the text (C=centered, L=left, R=right justified); multiline text is separated with the character ' ' (\$7C, dec: 124); 'NUL': (\$00) = end of string		
			J	x1	y1	n1	dow code	up code	text ...	NUL				
Define touch key with menu function	ESC	A	M	x1	y1	x2	y2	dow code	up code	mnu code	text ...	NUL	The area from xx1,yy1 to xx2,yy2 is defined as a menu key. 'down code':(1-255) Return/touch macro when pressed. 'up Code':(1-255) Return/touch macro when menu canceled 'mnu Code':(1-255) Return/menu macro+(item no. 1) after selection of a menu item. (down/up code = 0 activation/cancellation of the menu not reported). 'text':= string with the menu key text and the menu items. the first character determines the direction in which the menu opens (R=right, L=left, O=up, U=down). The second character determines the alignment of the touch key text . The different items are separated by the character ' ' (\$7C,dec:124) (e.g. "uckey item1 item2 item3". The key text is drawn with the current touch font and the menu items are drawn with the current menu font. The background of the menu is saved automatically.	
Define drawing area	ESC	A	D	x1	y1	x2	y2	n1	A drawing area is defined. You can then draw with a line width of n1 within the corner coordinates xx1,yy1 and xx2,yy2.					
Define free touch area	ESC	A	H	x1	y1	x2	y2	A freely usable touch area is defined. Touch actions (down, up and drag) within the corner coordinates xx1,yy1 and xx2,yy2 are sent via serial interface.						
Set bargraph by touch	ESC	A	B	no				The bar graph with the no=1..32 n1 is defined for input by touch panel.						
Touch: settings														
Touch frame	ESC	A	E	n1				The frame type for the display of touch keys/switches is set with n1				1		
Touch key response			I	n1				Automatic inversion when touch key touched: n1=0=OFF; n1=1=ON;				1		
			S	n1				Tone sounds briefly when a touch key is touched: n1=0=OFF; n1=1=ON				1		
			Invert touch key	N	code				The touch key with the assigned return code is inverted manually					
Query touch switch			X	code				The status of the switch (off=0; on=1) is sent via the serial interface						
Set touch switch			P	code	n1				The status of the switch is changed by means of a command n1=0=off; n1=1=on					
Define radiogroup			R	no				Within a group only one single switch will be active; ret of them will be deactivated no=0: next switch definitions will keep free of all groups no=1..255: next switch definitions will join to goup number no				0		
Delete touch area			L	code	n1				The touch area with the return code (code=0: all touch areas) is removed from the touch query. When n1=0, the area remains visible on the display; when n1=1, the area is deleted from the display.					
			V	x1	y1	n1				Remove a special touch area x1,y1 from touch query; n1=0: area stys visible; n1=1: areawill be overwritten with background color				
Send bar value on/off			Q	n1				Automatic transmission of a new bar graph value by touch input is deactivated (n1=0) or activated (n1=1)				1		
Touch query on/off	A	n1				Touch query is deactivated (n1=0) or activated (n1=1)				1				
Touch: Label font														
Label font	ESC	A	F	no				Set font with the number no=0..16 for touch key label				0		
Label zoom factor			Z	n1	n2				n1 = X zoom factor (1x..4x); n2 = Y zoom factor (1x..4x)				1,1	
Add. line spacing			Y	n1				Insert n1 pixels between two lines of text as additional line spacing						
Label angle			W	n1				Text output angle: n1=0: 0°; n1=1: 90°				0		

Response of EA eDIP240-7 via serial interface						
Id	num	data			Remark	
Automatic response						
ESC	A	1	code		Response from the analog touch panel when a key/switch is pressed. code = down or up code of the key/switch. Only transmitted if no corresponding touch macro is defined !	
ESC	N	1	code		After a menu item is selected by touch, the selected menu item code is transmitted. Only transmitted if no corresponding touch macro is defined !	
ESC	B	2	no	value	When a bar graph is set by touch, the current value of the bar is transmitted with no. Transmission of the bar value must be activated (see the 'ESC A Q n1' command).	
ESC	T	0			When automatic-open-mode for menu function is disabled (via command 'ESC N T n1'), this request will be sent to host. Then it is necessary that host will open menu with command 'ESC N T 2'.	
ESC	H	3	type	x1 y1	The following is transmitted in the case of a free touch area event: type=0 release; type=1 is touch; type=2 is drag within the free touch area at the x,y coordinates (16-bit values)	
Response only when requested						
ESC	N	1	no		After the 'ESC N S' command, the currently selected menu item is transmitted. no=0: no menu item is selected.	
ESC	B	2	no	value	After the 'ESC B S n1' command, the current value of the bar is transmitted with no.	
ESC	X	2	code	value	After the 'ESC A X' command, the current status of the touch switch is transmitted with code (the return code). value = 0 or 1	
ESC	I	count	X-Pixel, Y-Pixel, Version, Touchinfo, CRC-ROM, CRC-ROM reference EEP in KB, (abV1.4) CRC-EEP, CRC-EEP reference, EEPcount		(V1.3: count=14; V1.4: count = 21) After command 'ESC S I' eDIP sends internal information (16-Bit integer Werte LO- HI-Byte) Version: LO-Byte = Versionno. Software; HI-Byte = Versionno. Hardware Touchinfo: LO-Byte = '- +' X-axis; HI-Byte = '- +' Y-axis EEPcount: Count of used bytes in EEPROM (3 Byte: LO-, MID- HI-Byte)	
ESC	V	count	char. string...		After the 'ESC S V' command, the version of the eDIP firmware is transmitted as a string (end code is the character NUL = \$00). The first two bytes of the string always start with 'EA'	
Response without length specification (num)						
ESC	U	L	x1	y1	*.blh image data...	After command 'ESC UH...' is received a screen copy will be sent x1,y1 = coordinates of the top left corner *.blh image data: 2 bytes (width, height) + count of image data ((width+7)/8*height)

Note:

At pin 20 (SBUF), the display sets a low level to indicate that data is available to be fetched from the internal send buffer. This line can, for instance, be connected to an interrupt input of the host system.

TERMINAL MODE

The display provides a terminal function. When you switch it on, a cursor flashes in the first line, indicating that the display is ready for operation. All the incoming characters are displayed in ASCII format on the terminal (exception: CR,LF,FF,ESC,'#'). To achieve this, a correctly functioning protocol frame is required (pages 8 and 9) or the protocol must be deactivated (close solder strap J2, page 8 and 20). Line breaks are automatic or can be executed by means of the 'LF' character. If the last line is full, the contents of the terminal scroll upward. The 'FF' character (formfeed) clears the terminal.

The character '#' is used as an escape character and thus cannot be displayed directly on the terminal. If the character '#' is to be output on the terminal, it must be transmitted twice: '##'.

The terminal has a separate output layer and is thus completely independent of the graphic outputs. If the graphics screen is cleared with 'ESC DL', for example, that does not affect the contents of the terminal window. The terminal font is permanently in ROM and can also be used for graphics output 'ESC Z...' (set FONT no.=0).

	+ Lower	\$0 (0)	\$1 (1)	\$2 (2)	\$3 (3)	\$4 (4)	\$5 (5)	\$6 (6)	\$7 (7)	\$8 (8)	\$9 (9)	\$A (10)	\$B (11)	\$C (12)	\$D (13)	\$E (14)	\$F (15)
Upper			!	"	#	\$	%	&	'	()	*	+	,	-	.	/
\$20 (dez: 32)			!	"	#	\$	%	&	'	()	*	+	,	-	.	/
\$30 (dez: 48)		0	1	2	3	4	5	6	7	8	9	:	;	<	=	>	?
\$40 (dez: 64)		a	b	c	d	e	f	g	h	i	j	k	l	m	n	o	
\$50 (dez: 80)		p	q	r	s	t	u	v	w	x	y	z	[\]	^	_
\$60 (dez: 96)		~	a	b	c	d	e	f	g	h	i	j	k	l	m	n	o
\$70 (dez: 112)		p	q	r	s	t	u	v	w	x	y	z	{		}	~	Δ
\$80 (dez: 128)		€	ü	é	â	ä	à	ç	ê	ë	è	ï	î	í	ñ	Á	
\$90 (dez: 144)		é	æ	œ	ö	ö	ù	ù	ÿ	ö	ü	ç	£	¥	β	f	
\$A0 (dez: 160)		á	í	ó	ú	ñ	ñ	ë	ó	ç	í	½	¼	i	«	»	
\$B0 (dez: 176)																	
\$C0 (dez: 192)																	
\$D0 (dez: 208)																	
\$E0 (dez: 224)		α	β	Γ	π	Σ	σ	μ	τ	ϕ	θ	η	δ	φ	ε	π	
\$F0 (dez: 240)		≡	±	≥	≤	ρ	∫	÷	≈	°	*	.	√	n	z	3	-

Terminal-Font (Font 0): 8x8 monospaced

USING THE SERIAL INTERFACE

The EA eDIP240-7 can be programmed by means of various integrated commands. Each command begins with ESCAPE or HASH followed by one or two command letters and some parameters. There thus are two ways to send commands:

1. ASCII mode

- The ESC character corresponds to the character '#' (hex: \$23, dec: 35).
- The command letters come directly after the '#' character.
- The parameters are transmitted as plain text (several ASCII characters) followed by a separating character (such as a comma ',') - also after the last parameter e.g.: **#GD0,0,239,127,**
- Strings (text) are written directly without quotation marks and terminated with CR (hex: \$0D) or LF (hex: \$0A).

2. Binary mode

- The escape character corresponds to the character ESC (hex: \$1B, dec: 27).
- The command letters are sent directly.
- The x, y coordinates and all the other parameters are transmitted as 8-bit binary values (1 byte).
- Strings (text) are terminated with CR (hex: \$0D) or LF (hex: \$0A) or NUL (hex: \$00).

No separating characters, such as spaces or commas, may be used in binary mode. The commands require **no final byte**, such as a carriage return (apart from the string: \$00).

FILL PATTERNS

A pattern type can be set as a parameter with some commands. In this way, rectangular areas and bar graphs for instance can be filled with different patterns. There are 16 internal fill patterns available.

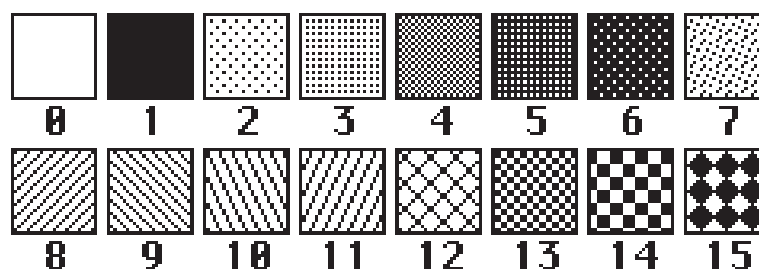

MACRO PROGRAMMING

Single or multiple command sequences can be grouped together in macros and stored in the EEPROM. You can then start them by using the *Run macro* commands. There are different types of macro:

Normal macros (0 through 255)

These are started by means of an 'ESC MN xx' command via the serial interface or from another macro. A series of macros occurring one after the other can be called cyclically (movie, hourglass, multi-page help text). These automatic macros continue to be processed until a command is received via RS-232 or another macro is activated.

Furthermore these macros may be started by "macro processes" as an individual task (from V1.1). Process macros will not be interrupted by any other commands or touch panel use.

Touch macro (1 through 255)

Started when you touch/release a touch field (only in versions with a touch panel - TP) or issue an 'ESC MT xx' command.

Menu macro (1 through 255)

Started when you choose a menu item or issue an 'ESC MM xx' command.

Power-on macro

Started after power-on. You can switch off the cursor and define an opening screen, for example.

Reset macro

Started after an external reset or after a voltage dip under 4.7V (VDD-VSS).

Watchdog macro

Started after a fault/error (e.g. crash).

Brown-out macro

Started after a voltage dip <4V.

Important: If a continuous loop is programmed in the power-on, reset or watchdog macro, the display can no longer be addressed. In this event, execution of the power-on macro must be suppressed. This is achieved by wiring DPOM appropriately.

PowerOff - connect pin 13 (DPOM) to GND - PowerOn - disconnect pin 13 again.

WRITE PROTECTION FOR MACRO PROGRAMMING AND FONTS

A VDD line level at pin 19 (EEP_WP) prevents inadvertent overwriting of the macros, images and fonts in the EEPROM (recommended in any case!).

MEMORY EXPANSION

The size of the internal EEPROM memory is 32 kB. Generally, this allows sufficient space for a large number of images and macros. If, however, a very large number of images (in particular full-size images) are to be stored, it can be necessary to expand the memory. The memory capacity can be doubled by directly connecting a standard EEPROM of the 24C256 series. It is connected over pins 17, 18 and 19 (I2C adress \$A6) or can be placed direct as U12 (see drawing on page 20).

IMAGES STORED IN EEPROM

To reduce the transmission times at the interface or to save storage space in the processor system, up to 256 images can be stored in the internal EEPROM. They can be called using the “ESC U I” command or from within a macro. Any images in Windows BMP format (monochrome images only) can be used. They can be created and edited using commercial software such as Windows Paint or Photoshop (only black and white = 1 bit).

CREATING YOUR OWN MACROS AND IMAGES

To create your own macros, you need the following:

- the additional EA 9777-1USB programmer (available as an accessory) or self-created adaptor like application example below,
- the ELECTRONIC ASSEMBLY LCD-Tools^{*)} software; this contains a KIT-Editor, KIT-Compiler, Simulator, and examples and fonts (for Windows PCs)
- a PC with a serial port USB or COM

To define a sequence of commands as a macro, all the commands are written to a file on the PC (e.g. DEMO.KMC). You specify which character sets are to be integrated and which command sequences are to be in which macros.

If the macros are defined using the KIT Editor, the KIT Compiler is started by pressing F5. This creates a file with the name DEMO.EEP which immediately shows the results in a simulator window (virtual display). If display is connected via USB programmer EA 9777-1USB or application below, this file is then automatically burned into the display's EEPROM. The KIT Compiler recognizes the display with or without the small protocol being activated.

The actual programming operation only takes a few seconds, and you can then use your user-defined macros and images on the display immediately. You will find a detailed description of how to program macros along with examples in the online Help for the ELECTRONIC ASSEMBLY LCD-Tools^{*)} software.

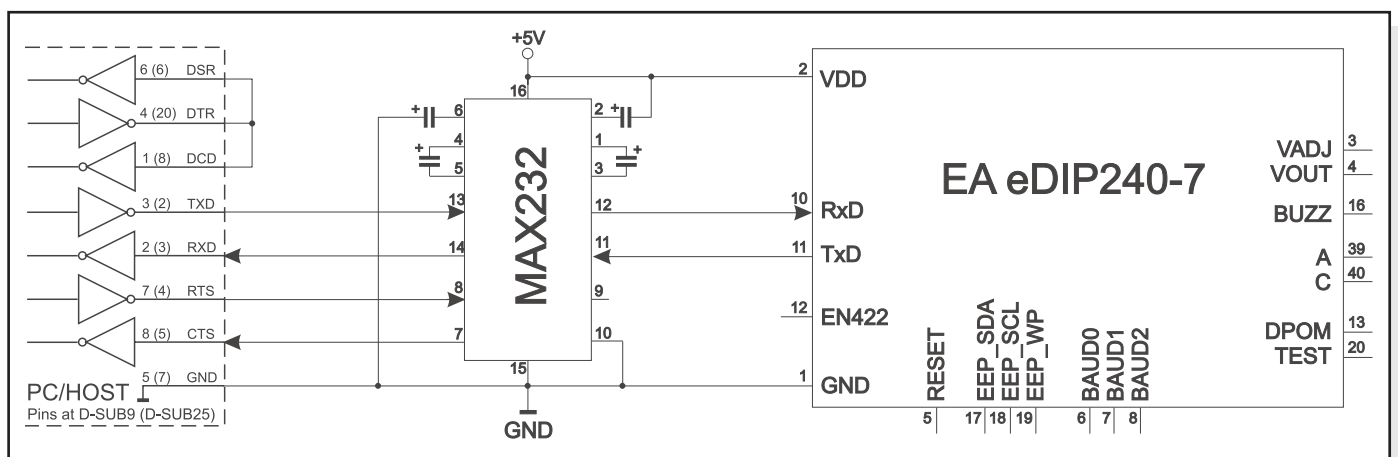

Application example to direct pc interfacing

^{*)} see our web site at <http://www.lcd-module.de/deu/touch/touch.htm>

DIMENSIONS

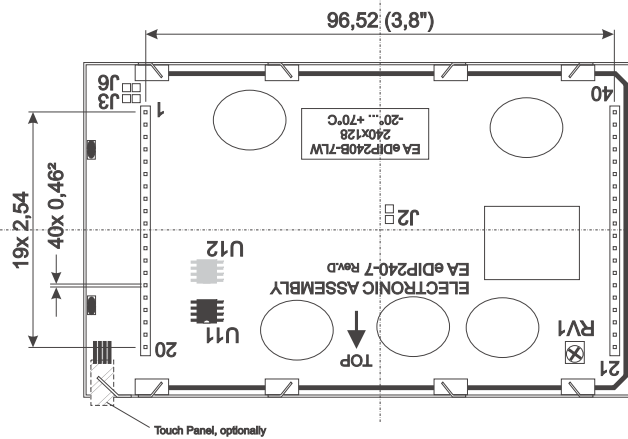
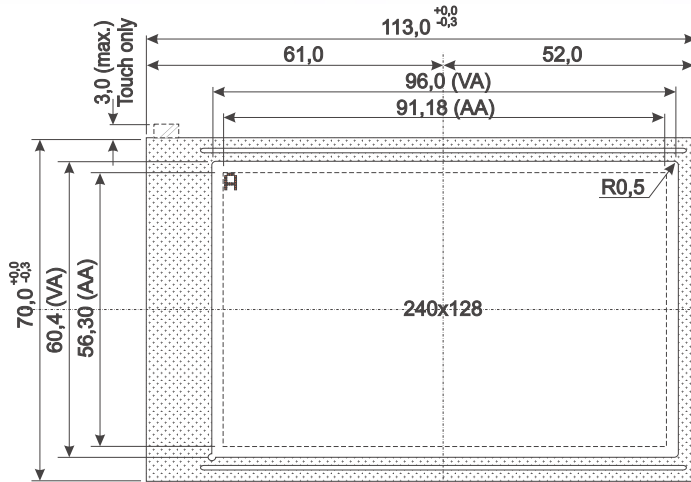

ohne Touchpanel

mit Touchpanel

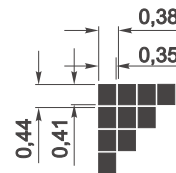
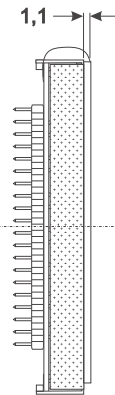
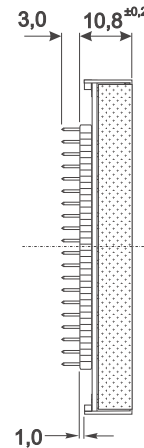

J2: switch off Small Protocoll
 J6: Connect Metal frame with GND (ESD / EMV)

all dimensions are in mm

ALUMINIUM BEZEL

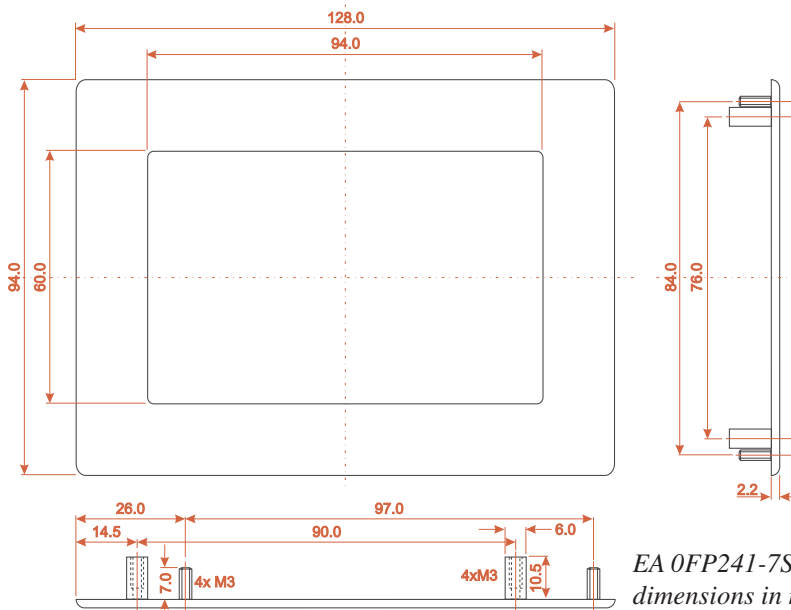

EA 0FP241-7SW:
 dimensions in mm

Notes on handling and operation

- LC displays are designed for hand soldering only. Reflow and wave soldering may destroy lcd immediately
- The following can lead to the electronic destruction of the module: cross-polarity or overvoltage of the power supply, overvoltage or cross-polarity or static discharge at the inputs, short-circuits at the outputs.
- The power supply must be disconnected before the module is removed. All inputs must also be free of voltage.
- The display and the touch screen are made of plastic and must not come into contact with hard objects. The surfaces can be cleaned with a soft cloth. No solvents may be used.
- The module is designed only for operation within buildings. Additional measures must be taken to allow operation in the open air. The maximum temperature range of -20 through +70°C must not be exceeded. The module may not operate correctly and may fail if used in a humid environment. The display must be shielded from direct sunlight.

ELECTRONIC ASSEMBLY

making things easy

Данный компонент на территории Российской Федерации

Вы можете приобрести в компании MosChip.

Для оперативного оформления запроса Вам необходимо перейти по данной ссылке:

<http://moschip.ru/get-element>

Вы можете разместить у нас заказ для любого Вашего проекта, будь то серийное производство или разработка единичного прибора.

В нашем ассортименте представлены ведущие мировые производители активных и пассивных электронных компонентов.

Нашей специализацией является поставка электронной компонентной базы двойного назначения, продукции таких производителей как XILINX, Intel (ex.ALTERA), Vicor, Microchip, Texas Instruments, Analog Devices, Mini-Circuits, Amphenol, Glenair.

Сотрудничество с глобальными дистрибьюторами электронных компонентов, предоставляет возможность заказывать и получать с международных складов практически любой перечень компонентов в оптимальные для Вас сроки.

На всех этапах разработки и производства наши партнеры могут получить квалифицированную поддержку опытных инженеров.

Система менеджмента качества компании отвечает требованиям в соответствии с ГОСТ Р ИСО 9001, ГОСТ РВ 0015-002 и ЭС РД 009

Офис по работе с юридическими лицами:

105318, г.Москва, ул.Щербаковская д.3, офис 1107, 1118, ДЦ «Щербаковский»

Телефон: +7 495 668-12-70 (многоканальный)

Факс: +7 495 668-12-70 (доб.304)

E-mail: info@moschip.ru

Skype отдела продаж:

moschip.ru

moschip.ru_4

moschip.ru_6

moschip.ru_9