

# Amphenol LMD and LMS Modular Connectors



## TABLE OF CONTENTS

### Amphenol LMD & LMS Modular Connectors

- Table of Contents . . . . .99
- Introduction - Features, Benefits, Performance ..100
- Features, Options & Contact Data . . . . .101
- LMD Housings - How to Order . . . . .102
- LMD Module Contact Arrangements . . . . .103, 104
- LMD Bussing Modules . . . . .105
- LMD Diode Modules & Relay Modules . . . . .106
- LMD Accessories . . . . .107
- LMD Assembly Instructions . . . . .108, 109
- LMS In-Line Splice Connector. . . . .110



### LMD & LMS Typical Markets:

- Commercial Avionics
- Avionics Instrumentation



Introduction/  
Pkg. Solutions/  
Brush Contact

LRM (Line Replaceable Modules)  
Options/  
Accessories

Ruggedized  
VME64x/  
VITA 60, 66

High Density  
HSB3  
HDB3  
Hi Speed

Low Mating Force MIL-DTL-55302  
Docking Conn./  
Accessories/Install.

Rack & Panel  
Brush  
Ruggedized

LMD/LMS  
Rectangular  
Interconnects

Other  
Rectangular  
Interconnects

**LMD Modular Connectors**

The LMD Connector Series was designed by Amphenol Pyle-National to provide flexibility in the assembly of wire harnesses that are used in instrumentation and avionic control environments. The modular design of the LMD provides rack and panel or cable to cable attachment.

**Design Features of LMD Connectors**

- An LMD Connector is comprised of a housing, modules and contacts - each ordered separately, requiring assembly
- Lightweight housings are offered in two materials
  - standard black thermoplastic
  - high performance composite material for EMI shielding
  - white thermoplastic nylon material with increased solvent resistance
- Four standard modules are available with the following contact arrangements: 1 #8, 4 #16, 9 #20, 16 #22
- Modules are available in sealed and unsealed versions
- Linear module design may be used for rack and panel or cable to cable applications
- Bussing modules available to allow for a plurality of circuit network configurations without extra hardware
- Diode modules provide a current protection system for avionic instrumentation packages and eliminate the need for dedicated PC boards and other hardware
- Miniature relay modules can be added which eliminate the need for printed circuit boards and hardware

**LMS Modular Connectors**

Supplementing the LMD connector family, Amphenol/Pyle National offers the LMS in-line splice connector; a low cost interconnects that incorporates the LMD modules and contacts.

- Standard LMS splice connector - 3-piece assembly with module removal tool access
- Tool-less splice connector - 3-piece assembly with a push-button module release for easy module removal
- Two-piece bracket available for panel mounting
- Used in wire harness, instrument and equipment terminations and test points



*LMD Receptacle and Plug*

**LMD Benefits**

- Reduces assembly and production costs
- Eliminates costly PC board and associated hardware
- Reduces inventory levels and associated costs
- Allows for a variety of circuit configurations
- Permits ease of circuit upgrading
- Facilitates equipment maintenance

**LMD Performance Characteristics**

Temperature Rating	-55° C to +140° C (-67° F to + 284° F)
Insulation Resistance (min.)	5000 megohms initial: 1000 megohms after 96 hours humidity
Durability	250 cycles (mating and unmating)
Vibration	Maximum discontinuity of one microsecond when subjected to sinusoidal vibration of 10 to 2000 Hz at 15 gravity units
Physical Shock	Maximum discontinuity of one microsecond when subjected to 1/2 -sine-wave transient shock of 50 gravity units with pulse duration of 11 milliseconds
Module Insertion & Removal Force	5 lbs. maximum
Module Retention	70 lbs. minimum



*LMS Tool-less Splice Connector*

## FEATURES, OPTIONS & CONTACT DATA



### LMD Features and Options

LMD's module options provide a mix of both active and passive devices within one connector. The features and options of this series describe the design flexibility in this connector series:

- LMD Standard components are molded of a U/L rated 94VO flame retardant, light-weight thermoplastic material. Alternate white nylon material (provides resistance to industrial oils and solvents) is available; consult Amphenol Aerospace for availability.
- The linear LMD connector may be used for rack and panel or cable-to-cable applications.
- Plug and receptacle housings may be front or rear panel mounted.
- Optional keying post provides six position keying capability.
- The optional center jackscrew provides ease of mating and unmating and insures high reliability under vibration.
- Cable strain reliefs are available for internal attachment. (See page 107).
- Variety of module types. Sealed and unsealed modules accept rear release #8, #16, #20 and #22 gauge contacts. Bussing, diode and relay modules available. PC tail contacts are also available; consult Amphenol Aerospace.
- A variety of contacts accept #8 through #28 AWG wire. Commercially available automated crimp terminating equipment may be used.
- Wired or unwired modules are rear inserted and held by two retention tines. With the aid of a front release tool, the modules are easily removed from the rear. (See pg. 107).
- Pin or socket modules may be intermixed in plug or receptacle housings.

### Contact Data

Contact Size	Wire Size	Contact Resistance		Dielectric Withstanding Voltage AC (RMS)	Max. Recommended Working Voltage AC (RMS)
		Test Current (amperes)	Max. Millivolts		
22	22	5.0	73	1800	600
	28	1.5	54		
20	20	7.5	55	1800	600
	24	3.0	45		
16	16	13.0	49	2300	900
	20	7.5	46		
8*	12	23	42	2300	900
	14	17	40		
8	8	46	26	2300	900
	10	33	28		

Contact Size	Wire Size	Contact Crimp Tensile Strength Lbs. Min.	Max. Wire Insulation
22	28	3	.054
	26	5	
	24	8	
	22	12	
20	24	8	.083
	22	12	
	20	20	
	20	20	
16	18	30	.103
	16	50	
	16	50	
8*	14	70	.255
	12	110	
8	10	150	.255
	8	220	

\* with #12 wire well

Introduction/  
Pig Solutions/  
Brush Contact

LRM (Line Replaceable Modules)  
Staggered/  
GEN-X  
Hybrids - Fiber Optics/  
Hi Speed/RF/Power  
Options/  
Accessories

Ruggedized  
VME 64X/  
VITA 60, 66

High Density  
HDB3  
HSP3  
Hi Speed

Low Mating Force MIL-DTL-55302  
Standard | Hybrids - Signal/Power/  
Brush  
Coax/Fiber Optics  
Docking Conn/  
Accessories/Install.

Rack & Panel  
Brush  
Ruggedized

LMD/LMS  
Rectangular  
Interconnects

Other  
Rectangular  
Interconnects

**HOW TO ORDER LMD HOUSINGS**

Housings are ordered separately from modules and contacts. Housings are available with 6 bays. Typical housing part number is shown as follows:

	1.	2.	3.	4.	5.	6.
1. Connector Type	Housing Material	Number of Modules	Connector Type	Coupling Mechanism	Alternate Keying	
<b>LMD</b>	<b>LMD</b>	<b>-0</b>	<b>6</b>	<b>P</b>	<b>J</b>	<b>3</b>

**2. Housing Material**

<b>0</b>	designates standard black thermoplastic
<b>F</b>	designates white thermoplastic nylon material - consult Amphenol for availability

**3. Number of Modules**

<b>6</b>	cavities in plug or receptacle housing (available in 6 only)
----------	--------------------------------------------------------------

**4. Connector Type**

<b>P</b>	designates plug
<b>R</b>	designates receptacle

**5. Coupling Mechanism**

<b>J</b>	designates jack-socket, rotating
<b>K</b>	designates jack-screw, fixed
<b>E</b>	designates without coupling mechanism

**6. Alternate Keying**

<b>3</b>	6 positions of keying post: 1, 2, 3, 4, 5 or 6
<b>7</b>	designates keying hardware shipped unassembled for field assembly
<b>8</b>	designates no alternate keying hardware. Keyed through housing only.

Ordering information on modules, contacts and strain reliefs is given on other pages of this LMD catalog section that follow.

**RECEPTACLE HOUSING  
6 BAY**



**PLUG HOUSING  
6 BAY**

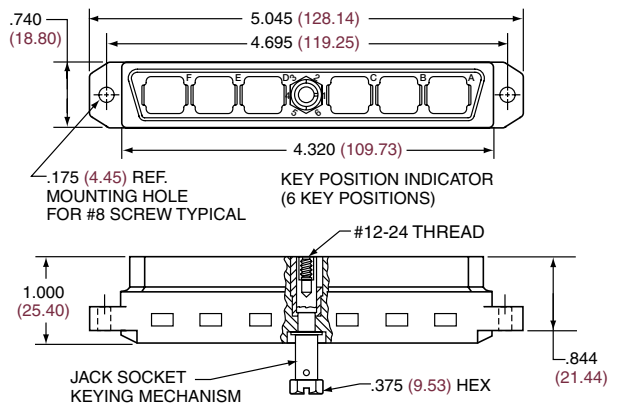

Introduction/  
Pkg. Solutions/  
Brush Contact

LRM (Line Replaceable Modules)  
Options/  
Accessories

Ruggedized  
VME64x/  
VITA 60, 66

High Density  
HSB3  
HDB3  
Hi Speed

Low Mating Force MIL-DTL-55302  
Docking Conn./  
Accessories/Install.

Rack & Panel  
Brush  
Ruggedized

LMD/LMS  
Rectangular  
Interconnects

Other  
Rectangular  
Interconnects



## MODULE CONTACT ARRANGEMENTS

Modules and contacts for LMD connectors are sold separately from housings.

### Modules with 16 Size 22 Contacts



**Socket Module**

**Pin Module**

**Part number:**  
LMD-3003-S

**Part number:**  
LMD-3003-P



**Sealed Socket Module**

**Sealed Pin Module**

**Part number:**  
LMD-4003-S

**Part number:**  
LMD-4003-P

### Modules with 9 Size 20 Contacts

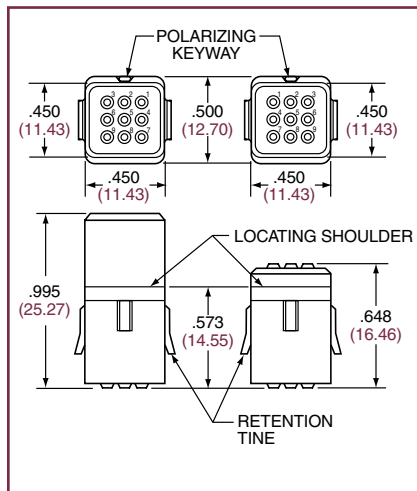

**Socket Module**

**Pin Module**

**Part number:**  
LMD-3001-S

**Part number:**  
LMD-3001-P

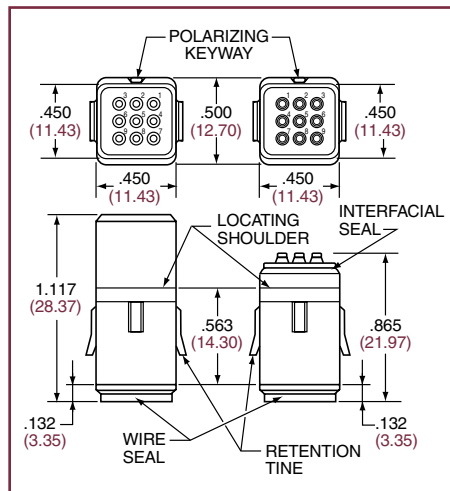

**Sealed Socket Module**

**Sealed Pin Module**

**Part number:**  
LMD-4001-S

**Part number:**  
LMD-4001-P

Module part numbers are for black thermoplastic material. Consult Amphenol Aerospace for availability of any other module materials.

### Pin Contact Size 22

**Part number: LMD-4022-36LJ**

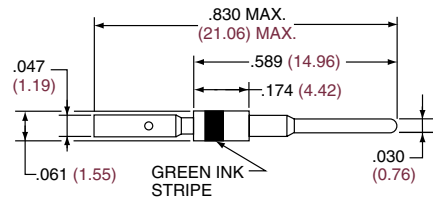

### Socket Contact Size 22

**Part number: LMD-4122-96LD**

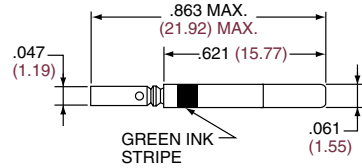

Contact Finish: Gold Plated

### Pin Contact Size 20

**Part number: LMD-4020-96LD**

**Thermocouple**

**Part Number: LMD-4020-10( )\***

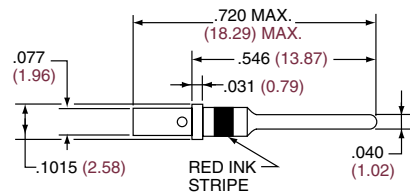

### Socket Contact Size 20

**Part number: LMD-4120-96LD**

**Thermocouple**

**Part Number: LMD-4120-10( )\***

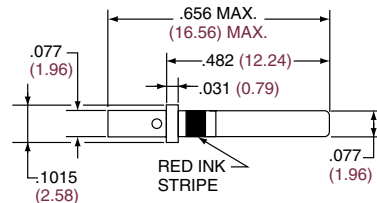

Contact Finish: Gold Plated

\*Complete thermocouple part number with code letter for desired contact material as follows:

- P = Chromel
- R = Alumel
- N = Constantan
- C = Copper

Introduction/  
Pig Solutions/  
Brush Contact

LRM (Line Replaceable Modules)  
Staggered/ Hybrids - Fiber Optics/  
GEN-X  
Hi Speed/RF/Power  
Options/  
Accessories

Ruggedized  
VME 64x/  
VITA 60, 66

High Density  
HDB3  
HSB3  
Hi Speed

Low Mating Force MIL-DTL-55302  
Standard | Hybrids - Signal/Power/  
Brush  
Coax/Fiber Optics  
Docking Conn/  
Accessories/Install.

Rack & Panel  
Brush  
Ruggedized

LMD/LMS  
Rectangular  
Interconnects

Other  
Rectangular  
Interconnects

Introduction/  
Pkg. Solutions/  
Brush Contact

LRM (Line Replaceable Modules)  
Options/  
Accessories

Ruggedized  
VME64x/  
VITA 60, 66

High Density  
HDB3  
HSB3  
Hi Speed

Low Mating Force MIL-DTL-55302  
Docking Conn./  
Accessories/Install.

Rack & Panel  
Brush  
Ruggedized

LMD/LMS  
Rectangular  
Interconnects

Other  
Rectangular  
Interconnects

Modules and contacts for LMD connectors are sold separately from housings.

#### Modules with 4 Size 16 Contacts



**Socket Module**  
Part number: LMD-3005-S

**Pin Module**  
Part number: LMD-3005-P



**Sealed Socket Module**  
Part number: LMD-4005-S

**Sealed Pin Module**  
Part number: LMD-4005-P

#### Modules with 1 Size 8 Contacts

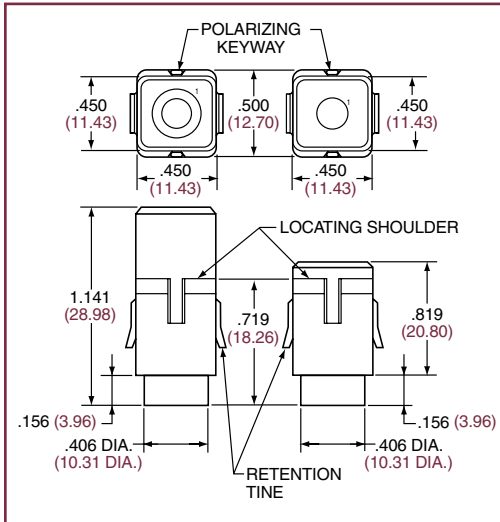

**Socket Module**  
Part number: LMD-3004-S

**Pin Module**  
Part number: LMD-3004-P

Module part numbers are for black thermoplastic material. Consult Amphenol Aerospace for availability of any other module materials.

#### Pin Contact Size 16 Part number: LMD-4016-96LD

#### Thermocouple Part Number: LMD-4016-10( )\*

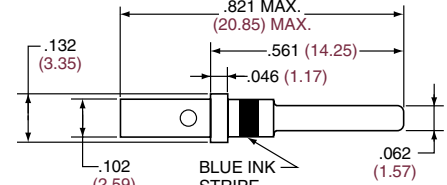

#### Socket Contact Size 16 Part number: LMD-4116-96LD

#### Thermocouple Part Number: LMD-4116-10( )\*

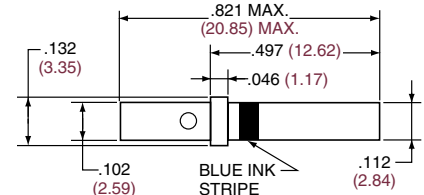

Contact Finish: Gold Plated  
\*Complete thermocouple part number with code letter for desired contact material as follows:  
P = Chromel  
R = Alumel  
N = Constantan  
C = Copper

#### Pin Contact Size 8 Part number: LMD-4008-36L

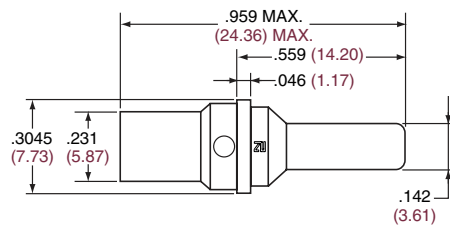

#### Socket Contact Size 8 Part number: LMD-4108-36L

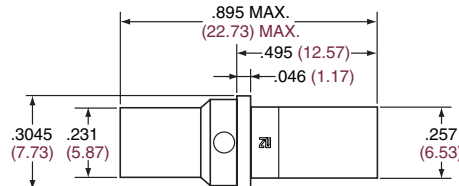

Contact Finish: Gold Plated

## BUSSING MODULES - FOR PLURAL CIRCUIT NETWORKS

Bussing Modules were designed by Amphenol Pyle-National to provide a complete terminal junction system. This module conveniently and simply allows for a plurality of circuit network configurations, eliminated the need for “pigtailed”, termination strips or termination hardware. Nine bussing configurations are currently available\* in either a standard or sealed module. Sealed modules have a rubber interfacial seal for increased environmental resistance. LMD Bussing Modules are currently available in black thermoplastic material.\*\*



### Modules with Size 22 Contacts

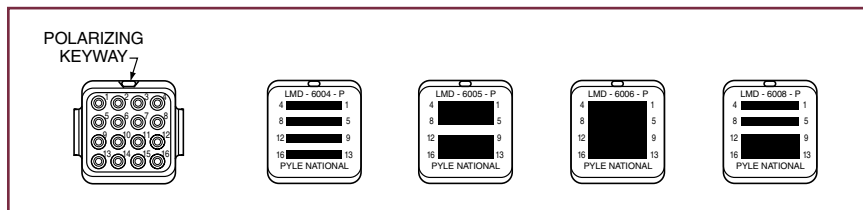

### Modules with Size 20 Contacts

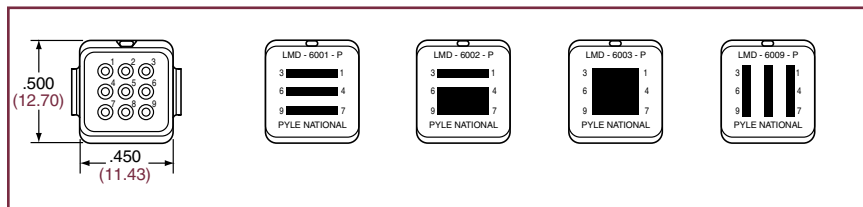

### Modules with Size 16 Contacts

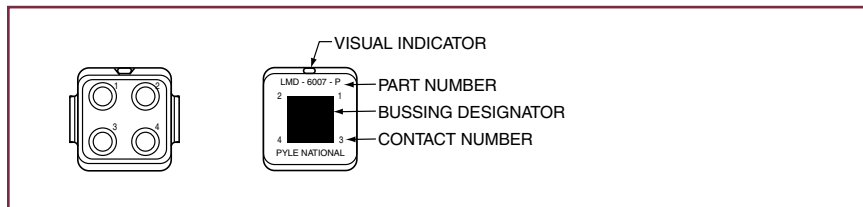

Contact Front View

Bussing Configuration (Rear View)

### Standard Bussing Module

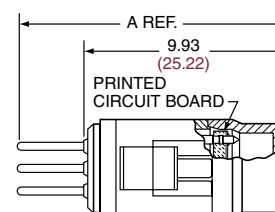

### Sealed Bussing Module

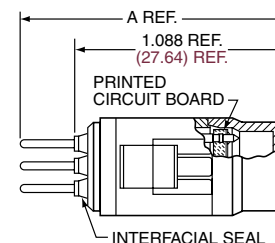

Module Side View

LMD Bussing Module Part Number		Contact Size	Bussing Circuits	A. Ref.
Standard Module	Sealed Module			
LMD-6001-P	LMD-6101-P	20	3	1.326
LMD-6002-P	LMD-6102-P	20	2	1.326
LMD-6003-P	LMD-6103-P	20	1	1.326
LMD-6004-P	LMD-6104-P	22	4	1.256
LMD-6005-P	LMD-6105-P	22	2	1.256
LMD-6006-P	LMD-6106-P	22	1	1.256
LMD-6007-P	LMD-6107-P	16	1	1.326
LMD-6008-P	LMD-6108-P	22	3	1.326
LMD-6009-P	LMD-6109-P	20	3	1.326

\* For other circuit network configurations, consult Amphenol Aerospace.

\*\* For availability of materials other than standard black thermoplastic, consult Amphenol Aerospace.

Introduction/  
Pig Solutions/  
Brush Contact

LRM (Line Replaceable Modules)

Staggered/  
GEN-X

Hybrids - Fiber Optics/  
Hi Speed/RF/Power

Options/  
Accessories

Ruggedized  
VME 64x/  
VITA 60, 66

High Density  
HDB3  
HSB3  
Hi Speed

Standard  
Brush

Low Mating Force MIL-DTL-55302

Hybrids - Signal/Power/  
Coax/Fiber Optics

Docking Conn/  
Accessories/Install.

Rack & Panel  
Brush  
Ruggedized

LMD/LMS  
Rectangular  
Interconnects

Other  
Rectangular  
Interconnects

### DIODE MODULES & RELAY MODULES

Introduction/  
Pkg. Solutions/  
Brush Contact

LRM (Line Replaceable Modules)  
Options/  
Hybrids - Fiber Optics / Staggered/  
GEN-X  
Hi Speed/RF/Power  
Accessories

Ruggedized  
VME64x/  
VITA 60, 66

High Density  
HDB3  
HSB3  
Hi Speed

Low Mating Force MIL-DTL-55302  
Hybrids - Signal/Power / Standard  
Coax/Fiber Optics  
Brush

Rack & Panel  
Brush  
Ruggedized

LMD/LMS  
Rectangular  
Interconnects

Other  
Rectangular  
Interconnects

Diode Modules provide a current protection system for Avionic instrumentation packages. Module configurations represent standard system and test application requirements.\*  
Diode Modules eliminate dedicated PC boards and other assorted hardware. These modules are available in sealed type only, incorporating an interfacial seal for environmental protection, and are manufactured of black thermoplastic material.\*\*



#### Diode Modules with Size 22 Contacts



#### Diode Modules with Size 20 Contacts

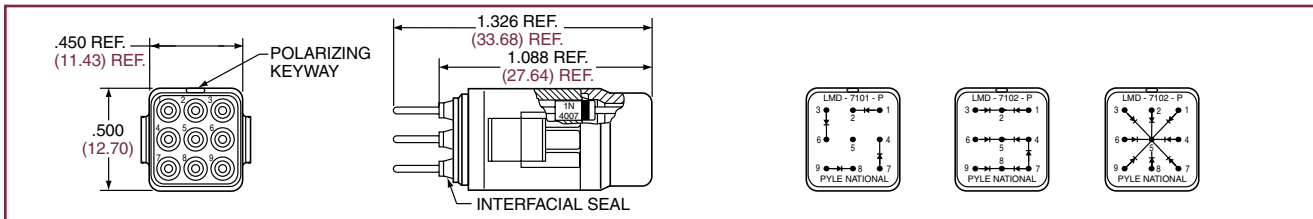

Contact Front View

Module Side View

Diode Configuration  
(Rear View)

LMD Diode Module Part Number	Contact Size	Circuit Description
LMD-7111-P	22	8 discrete diodes
LMD-7112-P	22	4 pair of diodes, each pair with common cathode
LMD-7113-P	22	8 diodes with common cathode (pin #1)
LMD-7101-P	20	4 discrete diodes
LMD-7102-P	20	3 pair of diodes, ear pair with common cathode
LMD-7103-P	20	8 diodes with common cathode (pin #5)

Relay Modules incorporate an industry standard miniature relay per MIL-R-39016 specification part number 39016/19-036L\* These modules eliminate the need for PC boards and all related hardware. These modules are available in unsealed and sealed types as shown below, and are manufactured of black thermoplastic material.\*\*

#### RELAY MODULES

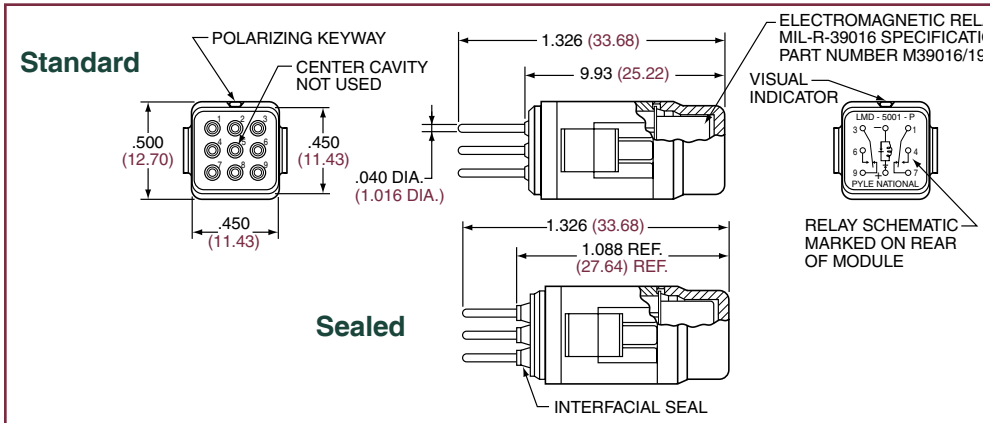

Contact Front View

Module Side View

Relay Configuration  
(Rear View)

LMD Relay Module Part Number	
Standard Module	Sealed Module
LMD-5001-P	LMD-5101-P

\* For other circuit network configurations, consult Amphenol Aerospace.

\*\* For availability of materials other than standard black thermoplastic, consult Amphenol Aerospace.



**STRAIN RELIEFS, CRIMPING, INSERTION/REMOVAL TOOLS**

**Strain Relief for Internal Attachment of Wiring**

**Part number: LMD-5300-10A**

Two-piece strain relief with cable tie included, for internal attachment to LMD 6 bay connector housings. Molded in black thermoplastic material.



**LMD TOOLS**

**Crimping Tool for Size 22 Contacts**

	Crimping Tool Part Number	Positioner		Wire Size	Crimp Tool Selector Setting
		For Pin Contact	For Socket Contact		
Amphenol/Pyle Number	TP-201401-H2	TP-201409	TP-201401-2-07	28	No. 1
Military Number	M22520/2-01	–	M22520/2-07	26	No. 2
				24	No. 3
				22	No. 4

**Crimping Tool for Size 20 & 16 Contacts**

	Crimping Tool Part Number	Turret Head	Contact Size	Wire Size	Crimp Tool Selector Setting
Military Number	M22520/1-01	M22520/1-02		22	No. 3
				20	No. 4
			16	20	No. 4
				18	No. 5
				16	No. 6

**Crimping Tool for Size 8 Contacts**

	Crimping Tool Part Number	Locator	For Size 8 Contacts		For Size 8 Contacts with #12 Wire Well	
			Wire Size	Crimp Tool Selector Setting	Wire Size	Crimp Tool Selector Setting
Amphenol/Pyle Number	TP-201393	TP-201408	10	No. 5	14	No. 2
Military Number	–	–	8	No. 7	12	No. 3

**Contact Insertion/Removal Tools**

Contact Size	Color	Amphenol/Pyle Part Number	Military Part Number
22	Green	10-538988-22D	MIL-I-81969/14-01
20	Red	10-538988-201	MIL-I-81969/14-02
16	Blue	10-538988-016	MIL-I-81969/14-03
8	Red	TP-201406	MIL-I-81969/29-02

**LMD Module Removal Tool**

**Part number: TP-201397**

See photo on page 109 of module removal with this tool.

LMD tools can be purchased from Daniels Manufacturing Company.

Introduction/  
Pig Solutions/  
Brush Contact

LRM (Line Replaceable Modules)  
Staggered/  
GEN-X

Hybrids- Fiber Optics/  
Hi Speed/RF/Power

Options/  
Accessories

Ruggedized  
VME 64X/  
VITA 60, 66

High Density  
HDB3  
HSP3  
Hi Speed

Low Mating Force MIL-DTL-55302  
Standard | Hybrids-Signal/Power/  
Brush  
Coax/Fiber Optics

Docking Conn/  
Accessories/Install.

Rack & Panel  
Brush  
Ruggedized

LMD/LMS  
Rectangular  
Interconnects

Other  
Rectangular  
Interconnects

Introduction/  
Pkg. Solutions/  
Brush Contact

Amphenol recommends the tools listed on the preceding page for use with LMD connectors, and also the following procedures for wire preparation, crimping of wire and contact insertion and removal.

LRM (Line Replaceable Modules)  
Options/  
Accessories

**Wire Preparation**



Strip wires to dimension "A" shown in table at right. Avoid cutting or nicking wire strands.

Contact Size	Wire Size	Max. O. D. Insulation	Stripping Length Dimension "A"
22	20-24-26-28 AWG	.054	.156 – .125
20	20-22-24 AWG	.083	.185 – .155
16	16-18-20 AWG	.103	.260 – .230
8 (with #12 crimp)	12-14 AWG	.255	.395 – .365
8	8-10 AWG	.255	.395 – .365

Ruggedized  
VME64x/  
VITA 60, 66

**Crimping Wire to Contacts**

Follow steps 1-3 for proper contact crimping.



1. Fully insert wire into contact crimp pocket. Wire must be visible through wire inspection hole.
2. Insert contact into tool (use proper crimping tool as listed on preceding page). Crimp contact to wire. Tool will not open if contact is not fully crimped.
3. After crimping, wire should be visible through wire inspection hole.

High Density  
HSB3  
Hi Speed

**Contact Insertion**



Using proper insertion/removal tool as listed on previous page, slip wire into insertion end (colored end), placing crimp end of contact inside the slotted portion and contact shoulder against end of tool.



Align contact with the cavity at the rear face of the module. Carefully push the contact into the full depth of the cavity. Withdraw tool. A slight axial pull on the wire will confirm contact is locked in proper position.

**Contact Removal**



Snap the extraction end (white end) of the tool over the wire of the contact selected for removal. Carefully push the tool into the full depth of the contact cavity releasing the contact retaining collet. Hold the wire against the serrations on the tool, and withdraw the tool and the wired contact from the module.

Low Mating Force MIL-DTL-55302  
Docking Conn./  
Accessories/Install.

Rack & Panel  
Brush  
Ruggedized

LMD/LMS  
Rectangular  
Interconnects

Other  
Rectangular  
Interconnects

## MODULE INSERTION/REMOVAL & USE OF STRAIN RELIEF

Pin or socket modules, wired or unwired, can be inserted or intermixed in plug or receptacle housings. Select from standard module configurations shown on pages 103 & 104, or select the optional bussing, diode or relay modules offered, shown on pages 105 & 106. The next instructions illustrate the proper method of insertion and removal of modules within the LMD connector.

### Module Insertion



Align the module with the proper cavity at the rear of the housing. The module keyway must be positioned to accept key in housing cavity. Carefully insert the module straight in to the cavity until fully seated and locked in place. A slight axial push on the front of the module or a pull on the cable bundle will confirm module is locked in proper position.

### Module Removal



Select module to be removed and place the blades of removal tool into the removal slots at the front of the connector. Push the removal tool into the full depth of the cavity, releasing the module retention tines.



With the module removal tool fully inserted, push the extraction plunger to eject the module out of the rear of the connector.

### Assembly of Internal Strain Relief

Strain reliefs, if required, may be assembled to plug or receptacle connectors which have a full complement of modules installed. The following is instruction for assembling the internal attachment strain relief, part number LMD-5300-10A (see page 107).



Tape wire bundle in area of cable clamp, and build up diameter to approx. 3/8 inches, if required. Align self-locking tines of the strain relief housing with the cavities adjacent to each module. Push the strain relief housing into place until the self-locking tines snap and lock strain relief into position. Assemble opposite half of strain relief housing to connector and tighten tie-strap to provide clamping force on the wire bundle.

### Opening Strain Relief to Service Modules and Contacts

Internal attachment strain reliefs may be opened to provide module and/or contact accessibility. To service connectors, first cut and discard tie-strap on strain relief. Open strain relief halves approx. 45° each by bending along integral flexible hinge. After servicing, close strain relief halves and install and tighten new tie-strap.

To completely remove strain relief from the housing in order to provide module access; first remove tie-strap, open strain relief halves 45° each, then remove module, then remove strain relief.



Introduction/  
Plug Solutions/  
Brush Contact

LRM (Line Replaceable Modules)  
Staggered/  
GEN-X

LRM (Line Replaceable Modules)  
Hybrids - Fiber Optics/  
Hi Speed/RF/Power  
Options/  
Accessories

Ruggedized  
VME 64X/  
VITA 60, 66

High Density  
HDB3  
HSP3  
Hi Speed

Low Mating Force MIL-DTL-55302  
Standard  
Brush

Hybrids - Signal/Power/  
Coax/Fiber Optics

Docking Conn/  
Accessories/Install.

Rack & Panel  
Brush  
Ruggedized

LMD/LMS  
Rectangular  
Interconnects

Other  
Rectangular  
Interconnects

Introduction/  
Pkg. Solutions/  
Brush Contact

LRM (Line Replaceable Modules)  
Options/  
Accessories

Ruggedized  
VME64x/  
VITA 60, 66

High Density  
HSB3  
HDB3  
Hi Speed

Low Mating Force MIL-DTL-55302  
Docking Conn./  
Accessories/Install.

Rack & Panel  
Brush  
Ruggedized

LMD/LMS  
Rectangular  
Interconnects

Other  
Rectangular  
Interconnects

## LMS Modular Connectors

Amphenol's LMS in-line splice connector incorporates LMD modules and contacts. The LMS is a simple, compact, three-piece assembly which is used in the following applications:

- Instrument terminations
- Equipment terminations
- Wire harness terminations
- Test points

The LMS double-ended tool-less splice (part number LMS-01T-TL) incorporated an integral release mechanism for easy tool-less module removal. It is manufactured of black thermoplastic material\* and is temperature rated at -55°C to +140°C (-67°F to +284°F).

The LMS connector uses the same standard modules, bussing modules, diode modules and/or relay modules as the LMD assemblies (see pages 103-105 for module and contact availability).

\* For availability of materials other than standard black thermoplastic, consult Amphenol Aerospace.

## LMS Two-Piece Bracket for Panel Mounting



## LMS Double-Ended In-Line Splice Housing Part Number: LMS-01T-TL



## LMS Panel Mounting Bracket Part Number: LMS-B1-01





## Данный компонент на территории Российской Федерации

### Вы можете приобрести в компании MosChip.

Для оперативного оформления запроса Вам необходимо перейти по данной ссылке:

<http://moschip.ru/get-element>

Вы можете разместить у нас заказ для любого Вашего проекта, будь то серийное производство или разработка единичного прибора.

В нашем ассортименте представлены ведущие мировые производители активных и пассивных электронных компонентов.

Нашей специализацией является поставка электронной компонентной базы двойного назначения, продукции таких производителей как XILINX, Intel (ex.ALTERA), Vicor, Microchip, Texas Instruments, Analog Devices, Mini-Circuits, Amphenol, Glenair.

Сотрудничество с глобальными дистрибьюторами электронных компонентов, предоставляет возможность заказывать и получать с международных складов практически любой перечень компонентов в оптимальные для Вас сроки.

На всех этапах разработки и производства наши партнеры могут получить квалифицированную поддержку опытных инженеров.

Система менеджмента качества компании отвечает требованиям в соответствии с ГОСТ Р ИСО 9001, ГОСТ РВ 0015-002 и ЭС РД 009

### Офис по работе с юридическими лицами:

105318, г.Москва, ул.Щербаковская д.3, офис 1107, 1118, ДЦ «Щербаковский»

Телефон: +7 495 668-12-70 (многоканальный)

Факс: +7 495 668-12-70 (доб.304)

E-mail: [info@moschip.ru](mailto:info@moschip.ru)

Skype отдела продаж:

moschip.ru

moschip.ru\_4

moschip.ru\_6

moschip.ru\_9