

## THL3502 and THL3512 Evaluation Board (THEVAL3502 and THEVAL3512) 24-channel LED Driver with LVDS Interface

### Overview

The THL35012 and THL3512 are LED driver with 24 channel open-drain outputs. The embedded oscillator and PWM controller individually generates 256-step brightness set by the dedicated registers for each channel. The serial interface of 2-pair LVDS lines (clock and data) features high-level noise tolerance, high-speed, and long-distance transmission. The LVDS allowing cascaded and multi-drop connection offers the maximum flexibility for designers to place and connect LED drivers. The simple and one-way communication protocol is easily-controlled and requires less CPU resources.

### Applications

- Amusement
- LED Backlight
- LED Display
- Digital Signage
- Illumination

### Features

- <Driver part>
  - Open-Drain Output: 16 channels
  - Output Sink Current: up to 100mA/ch
  - Output voltage: up to 40V
  - Individual Brightness Control: 256 steps
  - Group Brightness Control: 64 steps
  - Output disable/enable
- <Serial interface part>
  - 2-pair Serial LVDS Input or 3-wire Serial CMOS Input up to 10Mbps
  - Bridge Function Converting 3-wire Serial CMOS Input to 2-pair Serial LVDS Output
  - Repeater function of 2-pair Serial LVDS Input/ Output with Waveform and Timing Correction
  - Device Address Selection up to 62 addresses
  - General call to all devices
- <Protection Circuits>
  - UVLO, Overcurrent Protection, Thermal Shutdown
  - Supply Voltage: 3.0~5.5V
  - Package: QFN 48-pin Exposed Pad

### Description

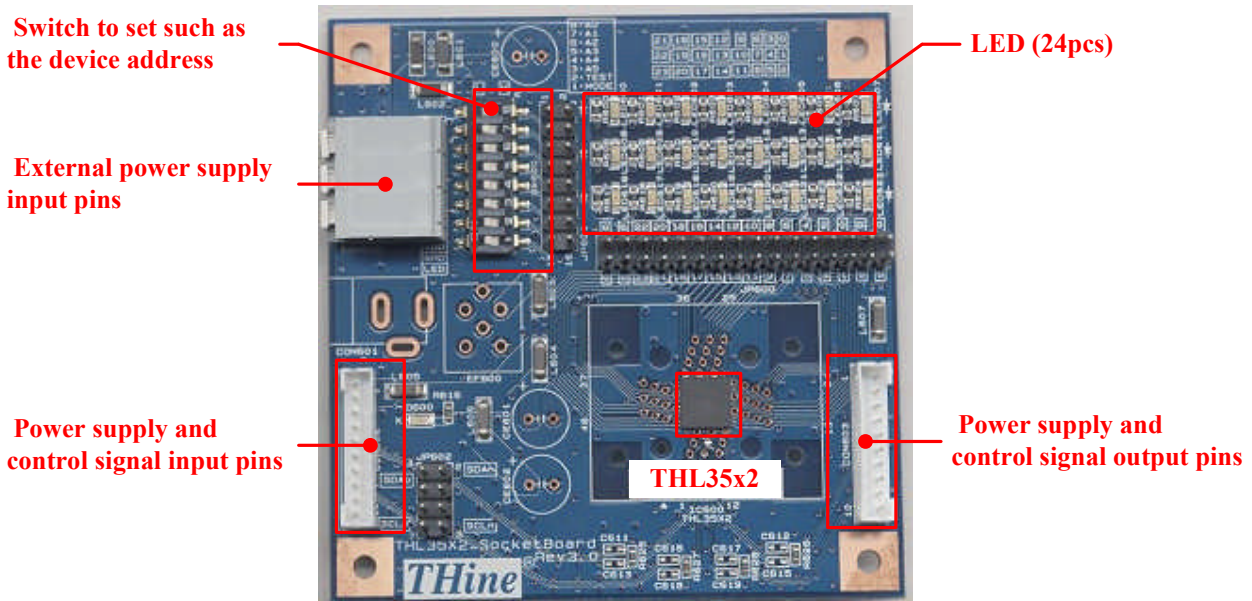
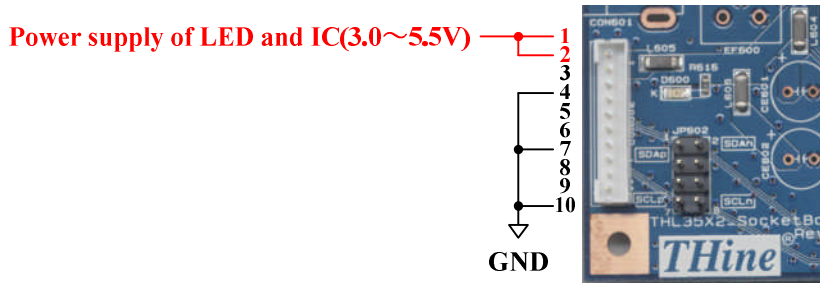

Figure 1 Board Overview

**Power Supply Inputs**

The method for connecting power supply inputs are shown below.

1) The all power supply inputs from the pre-stage. (Factory default settings)



**Figure 2 Power supply from pre-stage**

2) The all power supply inputs from the external unit.

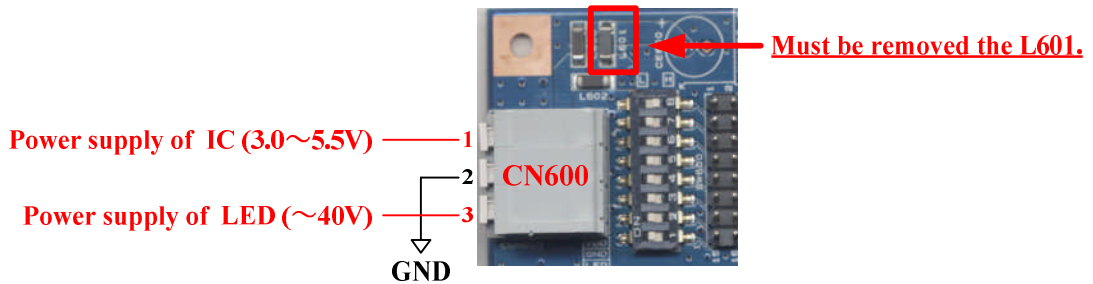

**Figure 3 Power supply from external unit**

3) The power supply of LED inputs from the external unit and the power supply of IC inputs from the pre-stage.

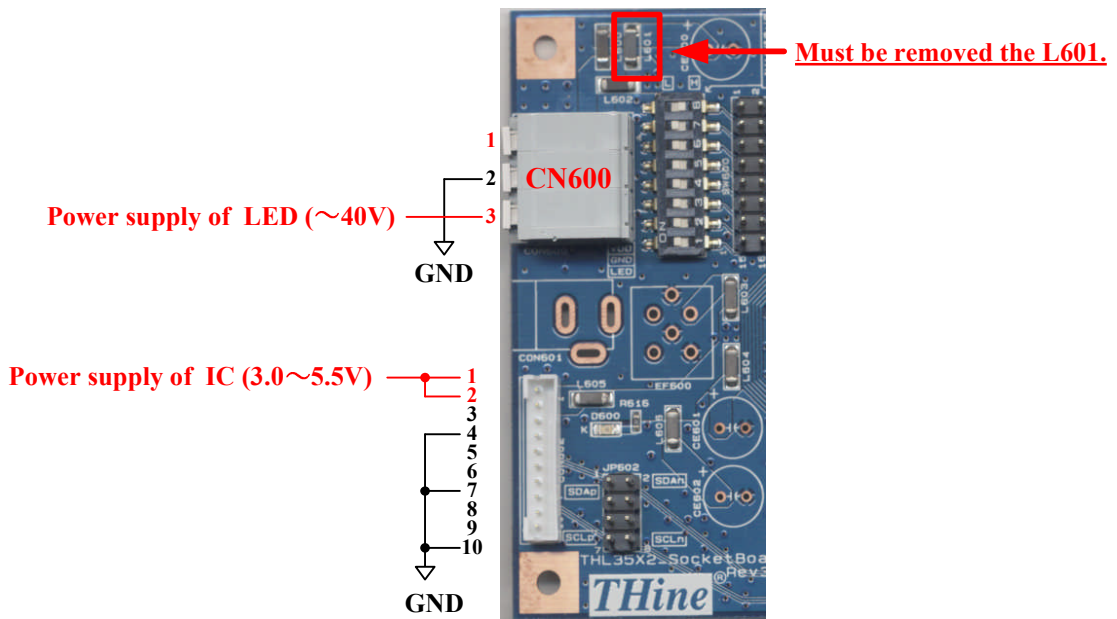

**Figure 4 Power supply from external unit and pre-stage**

### **Dip-Switch Setting**

Dip-Switch can set the device address and the control signal input mode.

#2 TEST always set to Low.

1) Setting of the device address.

Device address can set the A0 to A5. Switch is the Low level when the ON side.

2) Setting of the control signal input mode.

Please refer to the following control signal input mode settings.

**Table 1 Control signal input mode**

Input Mode	MODE pin
3 wire serial CMOS	High
2 wire serial LVDS	Low

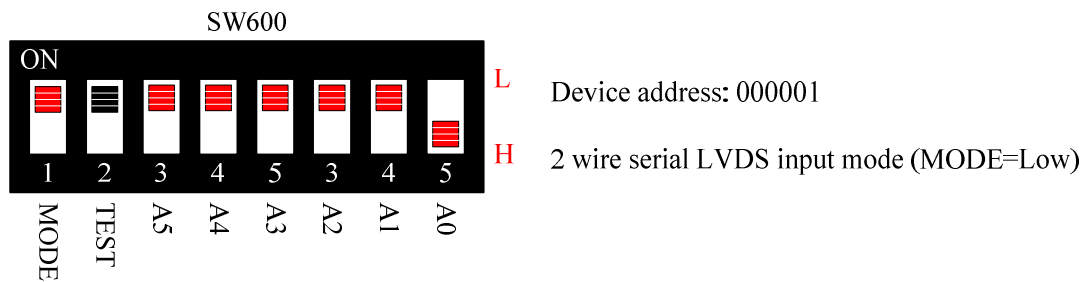

**Figure 5 Example for DIP-Switch**

### **Input Mode Setting**

In the case of change the control signal input mode, The following processing is required.

1) To 2 wire serial LVDS input: Please implement the 100 ohm resistor to R625 and R627.

(Factory default settings)

2) To 3 wire serial CMOS input: Please remove the 100 ohm resistor from R625 and R627.

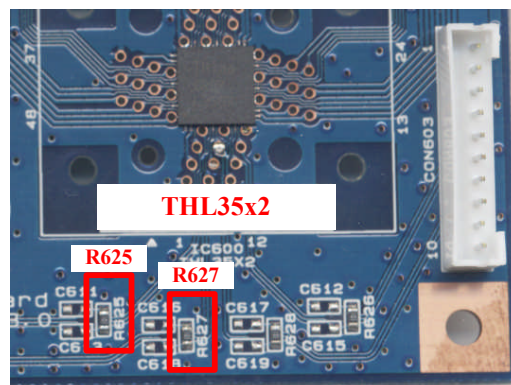

**Figure 6 Processed terminal resistor**

**Board schematic**

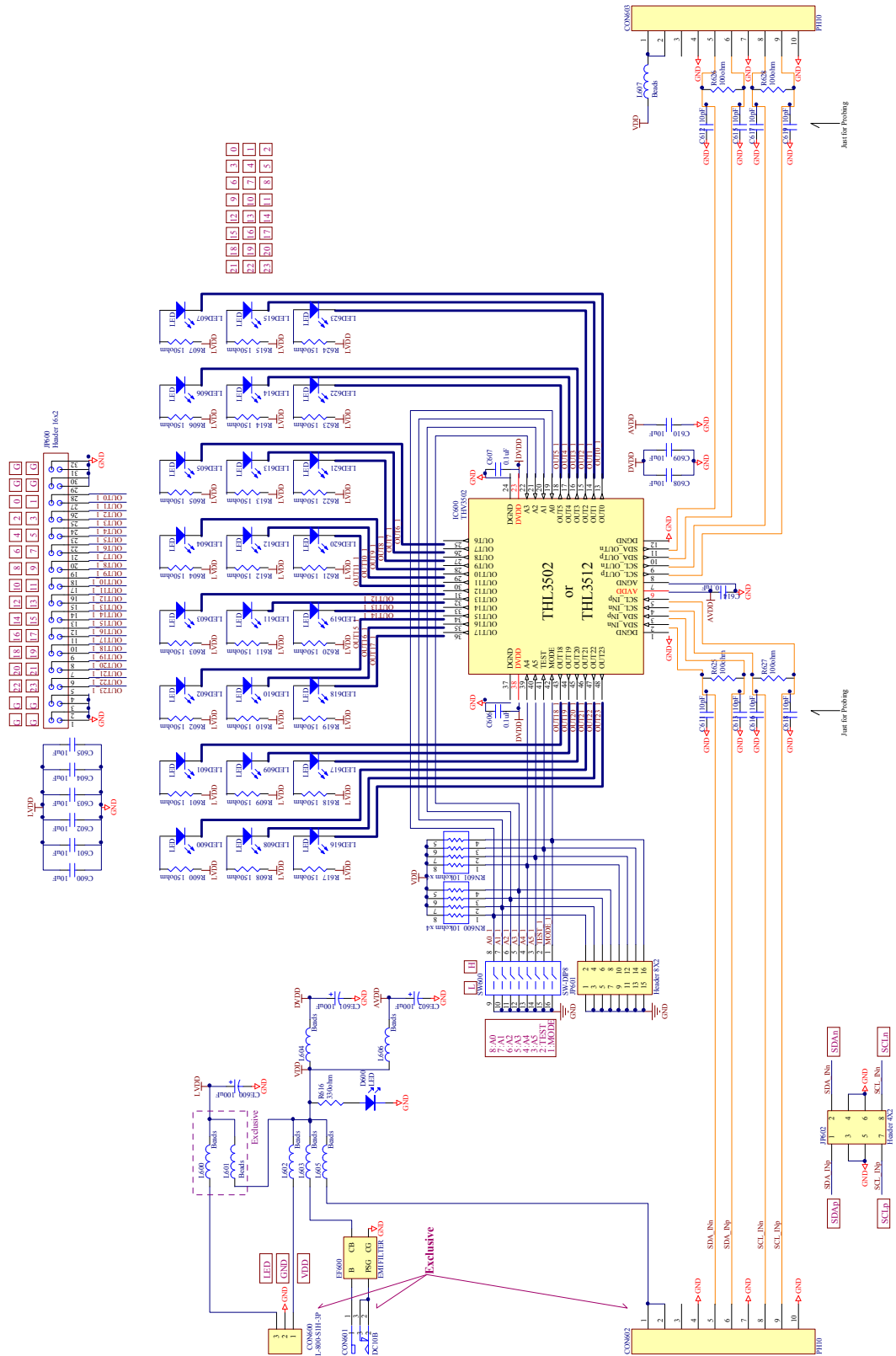

**Figure 7 Board schematic**

**■Bill of materials**

**Table 2 Bill of materials**

#	Designator	Description	Size	Part Number	Manufacturer
1	C600	Capacitor	3225	GRM32EB31H106KA12	Murata
2	C601	Capacitor	3225	GRM32EB31H106KA12	Murata
3	C602	Capacitor	3225	GRM32EB31H106KA12	Murata
4	C603	Capacitor	3225	GRM32EB31H106KA12	Murata
5	C604	Capacitor	3225	GRM32EB31H106KA12	Murata
6	C605	Capacitor	3225	GRM32EB31H106KA12	Murata
7	C606	Capacitor	1608	GRM188B31H104KA92	Murata
8	C607	Capacitor	1608	GRM188B31H104KA92	Murata
9	C608	Capacitor	3225	GRM32EB31H106KA12	Murata
10	C609	Capacitor	3225	GRM32EB31H106KA12	Murata
11	C610	Capacitor	3225	GRM32EB31H106KA12	Murata
12	C614	Capacitor	1608	GRM188B31H104KA92	Murata
13	CON600	Connector		ML-800-S1H-3P	Sato-parts
14	CON602	Nylon Connector		B10B-PH-K-S(LF)(SN)	JST
15	CON603	Nylon Connector		B10B-PH-K-S(LF)(SN)	JST
16	D600	LED		SML-210LT	Rohm
17	IC600	LED Driver	QFN48	THL3502 or THL3512	THine
18	JP502	Pin Header	2.54mm pitch	JTW-2500	Hirosugi-Keiki
19	JP600	Pin Header	2.54mm pitch	JTW-2500	Hirosugi-Keiki
20	JP601	Pin Header	2.54mm pitch	JTW-2500	Hirosugi-Keiki
21	L600	Bead	4516	BLM41PG600SN1L	Murata
22	L602	Bead	4516	BLM41PG600SN1L	Murata
23	L603	Bead	4516	BLM41PG600SN1L	Murata
24	L604	Bead	4516	BLM41PG600SN1L	Murata
25	L605	Bead	4516	BLM41PG600SN1L	Murata
26	L606	Bead	4516	BLM41PG600SN1L	Murata
27	L607	Bead	4516	BLM41PG600SN1L	Murata
28	LED600	LED	2012	PY1112H-TR	Stanley
29	LED601	LED	2012	PY1112H-TR	Stanley
30	LED602	LED	2012	PY1112H-TR	Stanley
31	LED603	LED	2012	PY1112H-TR	Stanley
32	LED604	LED	2012	PY1112H-TR	Stanley
33	LED605	LED	2012	PY1112H-TR	Stanley
34	LED606	LED	2012	PY1112H-TR	Stanley
35	LED607	LED	2012	PY1112H-TR	Stanley
36	LED608	LED	2012	PY1112H-TR	Stanley
37	LED609	LED	2012	PY1112H-TR	Stanley
38	LED610	LED	2012	PY1112H-TR	Stanley
39	LED611	LED	2012	PY1112H-TR	Stanley
40	LED612	LED	2012	PY1112H-TR	Stanley
41	LED613	LED	2012	PY1112H-TR	Stanley
42	LED614	LED	2012	PY1112H-TR	Stanley
43	LED615	LED	2012	PY1112H-TR	Stanley
44	LED616	LED	2012	PY1112H-TR	Stanley
45	LED617	LED	2012	PY1112H-TR	Stanley
46	LED618	LED	2012	PY1112H-TR	Stanley
47	LED619	LED	2012	PY1112H-TR	Stanley
48	LED620	LED	2012	PY1112H-TR	Stanley
49	LED621	LED	2012	PY1112H-TR	Stanley
50	LED622	LED	2012	PY1112H-TR	Stanley
51	LED623	LED	2012	PY1112H-TR	Stanley
52	R600	Resistor	1608	RK73B1JBK151J	KOA
53	R601	Resistor	1608	RK73B1JBK151J	KOA
54	R602	Resistor	1608	RK73B1JBK151J	KOA
55	R603	Resistor	1608	RK73B1JBK151J	KOA
56	R604	Resistor	1608	RK73B1JBK151J	KOA
57	R605	Resistor	1608	RK73B1JBK151J	KOA
58	R606	Resistor	1608	RK73B1JBK151J	KOA
59	R607	Resistor	1608	RK73B1JBK151J	KOA
60	R608	Resistor	1608	RK73B1JBK151J	KOA
61	R609	Resistor	1608	RK73B1JBK151J	KOA
62	R610	Resistor	1608	RK73B1JBK151J	KOA
63	R611	Resistor	1608	RK73B1JBK151J	KOA
64	R612	Resistor	1608	RK73B1JBK151J	KOA
65	R613	Resistor	1608	RK73B1JBK151J	KOA
66	R614	Resistor	1608	RK73B1JBK151J	KOA
67	R615	Resistor	1608	RK73B1JBK151J	KOA
68	R616	Resistor	1608	RK73B1JBK331J	KOA
69	R617	Resistor	1608	RK73B1JBK151J	KOA
70	R618	Resistor	1608	RK73B1JBK151J	KOA
71	R619	Resistor	1608	RK73B1JBK151J	KOA
72	R620	Resistor	1608	RK73B1JBK151J	KOA
73	R621	Resistor	1608	RK73B1JBK151J	KOA
74	R622	Resistor	1608	RK73B1JBK151J	KOA
75	R623	Resistor	1608	RK73B1JBK151J	KOA
76	R624	Resistor	1608	RK73B1JBK151J	KOA
77	R625	Resistor	1608	RK73B1JBK101J	KOA
78	R626	Resistor	1608	RK73B1JBK101J	KOA
79	R627	Resistor	1608	RK73B1JBK101J	KOA
80	R628	Resistor	1608	RK73B1JBK101J	KOA
81	RN600	Resistor Array	3216	CN1J4TTD103J	KOA
82	RN601	Resistor Array	3216	CN1J4TTD103J	KOA
83	SW600	DIP Switch		A6S-8101-H	Omron

## **Notices and Requests**

1. The product specifications described in this material are subject to change without prior notice.
2. The circuit diagrams described in this material are examples of the application which may not always apply to the customer's design. We are not responsible for possible errors and omissions in this material. Please note if errors or omissions should be found in this material, we may not be able to correct them immediately.
3. This material contains our copyright, know-how or other proprietary. Copying or disclosing to third parties the contents of this material without our prior permission is prohibited.
4. Note that if infringement of any third party's industrial ownership should occur by using this product, we will be exempted from the responsibility unless it directly relates to the production process or functions of the product.
5. This product is presumed to be used for general electric equipment, not for the applications which require very high reliability (including medical equipment directly concerning people's life, aerospace equipment, or nuclear control equipment). Also, when using this product for the equipment concerned with the control and safety of the transportation means, the traffic signal equipment, or various Types of safety equipment, please do it after applying appropriate measures to the product.
6. Despite our utmost efforts to improve the quality and reliability of the product, faults will occur with a certain small probability, which is inevitable to a semi-conductor product. Therefore, you are encouraged to have sufficiently redundant or error preventive design applied to the use of the product so as not to have our product cause any social or public damage.
7. Please note that this product is not designed to be radiation-proof.
8. Customers are asked, if required, to judge by themselves if this product falls under the category of strategic goods under the Foreign Exchange and Foreign Trade Control Law.
9. The product or peripheral parts may be damaged by a surge in voltage over the absolute maximum ratings or malfunction, if pins of the product are shorted by such as foreign substance. The damages may cause a smoking and ignition. Therefore, you are encouraged to implement safety measures by adding protection devices, such as fuses.

***THine Electronics, Inc.***  
sales@thine.co.jp

# Mouser Electronics

Authorized Distributor

Click to View Pricing, Inventory, Delivery & Lifecycle Information:

CEL:

[THEVAL3502](#)

## Данный компонент на территории Российской Федерации

### Вы можете приобрести в компании MosChip.

Для оперативного оформления запроса Вам необходимо перейти по данной ссылке:

<http://moschip.ru/get-element>

Вы можете разместить у нас заказ для любого Вашего проекта, будь то серийное производство или разработка единичного прибора.

В нашем ассортименте представлены ведущие мировые производители активных и пассивных электронных компонентов.

Нашей специализацией является поставка электронной компонентной базы двойного назначения, продукции таких производителей как XILINX, Intel (ex.ALTERA), Vicor, Microchip, Texas Instruments, Analog Devices, Mini-Circuits, Amphenol, Glenair.

Сотрудничество с глобальными дистрибьюторами электронных компонентов, предоставляет возможность заказывать и получать с международных складов практически любой перечень компонентов в оптимальные для Вас сроки.

На всех этапах разработки и производства наши партнеры могут получить квалифицированную поддержку опытных инженеров.

Система менеджмента качества компании отвечает требованиям в соответствии с ГОСТ Р ИСО 9001, ГОСТ РВ 0015-002 и ЭС РД 009

### Офис по работе с юридическими лицами:

105318, г.Москва, ул.Щербаковская д.3, офис 1107, 1118, ДЦ «Щербаковский»

Телефон: +7 495 668-12-70 (многоканальный)

Факс: +7 495 668-12-70 (доб.304)

E-mail: [info@moschip.ru](mailto:info@moschip.ru)

Skype отдела продаж:

moschip.ru

moschip.ru\_4

moschip.ru\_6

moschip.ru\_9