

# Self-powered Totalizer New H7E

CSM\_H7E\_-N\_DS\_E\_7\_1

## Compact Economical Totalizer with High Visibility Available with Backlit LCD Display

- Large display with 8.6-mm character height.
- Includes new models with backlight for improved visibility in dimly lit places. (Requires 24-VDC power supply.)
- Black and light-gray cases now available.
- PNP/NPN universal DC voltage input types now available.
- Battery is replaceable for Totalizer reuse and conservation of the environment.
- Key-protect switch to prevent faulty reset key operation.
- Dual operation mode.
- Front face compatible with NEMA4/IP66.
- Short body, all models have a depth of 48.5 mm.
- Finger protection terminal block conforms to VDE0106, Part100.
- Conforms to UL, CSA, and CE marking.  
Conforms to EN61010-1 (pollution degree 2/overvoltage category III.)
- Conforms to EMC standards and EN61326, thus allowing use in residential, commercial and light- and heavy-industry environments.
- Six-language instruction manual provided.
- PCB-mounting models available. (Requires 3-V power supply.)

## ■ Broad Line-up of the New H7E Series



### Contents

<b>Self-powered Totalizers</b>	
H7EC.....	2
H7ET.....	9
H7ER.....	16
H7E□-N□P.....	22
<b>Common to All Totalizers</b>	
Accessories.....	27
Precautions.....	29

# Self-powered Total Counter New H7EC

- Eight-digits, counting range 0 to 99999999.
- Dual input speed: 30 Hz ↔ 1 kHz (except for AC/DC multi-voltage input models)



## Model Number Structure

### Model Number Legend

Note: Some configurations are not available.

H7EC - N   -      
1 2 3

#### 1. Count Input

- None: No-voltage input
- V: PNP/NPN universal DC voltage input
- FV: AC/DC multi-voltage input

#### 2. Case Color

- None: Light gray
- B: Black

#### 3. Display

- None: 7-segment LCD without backlight
- H: 7-segment LCD with backlight

## Ordering Information

### Total Counters

Count input	Max. counting speed	Display	Model	
			Light-gray body	Black body
PNP/NPN universal DC voltage input (4.5 to 30 VDC)	30 Hz ↔ 1 kHz (switchable)	7-segment LCD with backlight	H7EC-NV-H	H7EC-NV-BH
		7-segment LCD	H7EC-NV	H7EC-NV-B
AC/DC multi-voltage input (24 to 240 VAC/VDC)	20 Hz	7-segment LCD	H7EC-NFV	H7EC-NFV-B
No-voltage	30 Hz ↔ 1 kHz (switchable)	7-segment LCD	H7EC-N	H7EC-N-B

### Accessories (Order Separately)

Name	Model
Compact Flush Mounting Bracket	Y92F-35
Flush Mounting Bracket (See note 1)	Y92F-34
Wire-wrap Terminal (set of two Terminals)	Y92S-37
Lithium Battery (See note 2)	Y92S-36
Waterproof Packing (See note 1)	Y92S-32

Note: 1. Provided with H7EC. (Order additional Brackets separately as required.)

2. Built into H7EC. Order replacements using the above model number before the service life expires.

# Specifications

## General

Item	H7EC-NV-□ H7EC-NV-□H	H7EC-NFV-□	H7EC-N-□
Operating mode	Up type		
Mounting method	Flush mounting		
External connections	Screw terminals, optional Wire-wrap Terminals (see note 1)		
Reset	External/Manual reset		
Number of digits	8		
Count input	PNP/NPN universal DC voltage input	AC/DC multi-voltage input	No-voltage input
Display	7-segment LCD with or without backlight, zero suppression (character height: 8.6 mm) (see note 2)		
Max. counting speed	30 Hz/1 kHz	20 Hz	30 Hz/1 kHz
Case color	Light gray or black (-B models)		
Attachment	Waterproof packing, Y92F-34 Flush Mounting Bracket		
Approved standard	UL863, CSA C22.2 No.14, Lloyds Conforms to EN61010-1/IEC61010-1 (Pollution degree2/overvoltage category III) Conforms to VDE0106/P100		

- Note:** 1. Separately ordered Wire-wrap Terminals (Y92S-37) are required.  
2. Only PNP/NPN universal DC voltage input models (-H models) have a backlight.

## Ratings

Item	H7EC-NV-□ H7EC-NV-□H	H7EC-NFV-□	H7EC-N-□
Supply voltage	Backlight model: 24 VDC (0.3 W max.) (only for backlight) No-backlight model: Not required (powered by built-in battery)	Not required (powered by built-in battery)	
Count input	High (logic) level: 4.5 to 30 VDC Low (logic) level: 0 to 2 VDC (Input impedance: Approx. 4.7 kΩ)	High (logic) level: 24 to 240 VAC/VDC, 50/60 Hz Low (logic) level: 0 to 2.4 VAC/VDC, 50/ 60 Hz	No voltage input Maximum short-circuit impedance: 10 kΩ max. Short-circuit residual voltage: 0.5 V max. Minimum open impedance: 750 kΩ min.
Reset input		No voltage input Maximum short-circuit impedance: 10 kΩ max. Short-circuit residual voltage: 0.5 V max. Minimum open impedance: 750 kΩ min.	
Max. counting speed (see note)	30 Hz or 1 KHz (Switchable with switch)	20 Hz	30 Hz or 1 KHz (Switchable with switch)
Minimum signal width	20 Hz: 25 ms 30 Hz: 16.7 ms 1 KHz: 0.5 ms		
Reset system	External reset and manual reset: Minimum signal width of 20 ms		
Terminal screw tightening torque	0.98 N·m max.		
Ambient temperature	Operating: -10°C to 55°C (with no condensation or icing) Storage: -25°C to 65°C (with no condensation or icing)		
Ambient humidity	Operating 25% to 85%		

**Note:** ON/OFF ratio 1:1



# Connections

## Terminal Arrangement

Bottom view: View of the Total Counter rotated horizontally 180°

Backlight Model



No-backlight Model



## Connections

### H7EC Total Counter

#### PNP/NPN Universal DC Voltage Input Model With Backlight

1. Contact Input (Input by a Relay or Switch Contact)
2. Solid-state Input



- Note:**
1. Terminals 2 and 4 (input circuit and reset circuit) are functionally isolated.
  2. Select input transistors according to the following:  
Dielectric strength of the collector  $\geq 50$  V  
Leakage current  $< 100 \mu\text{A}$

## PNP/NPN Universal DC Voltage Input Model Without Backlight

### 1. Contact Input (Input by a Relay or Switch Contact)



### 2. Solid-state Input

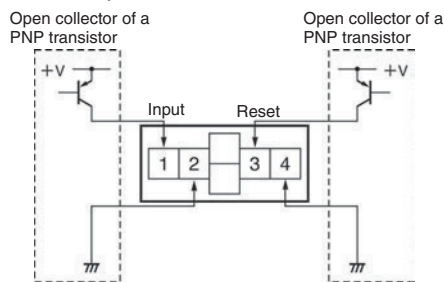

**Note:** 1. Terminals 2 and 4 (input circuit and reset circuit) are functionally isolated.

2. Select input transistors according to the following:  
Dielectric strength of the collector  $\geq 50$  V  
Leakage current  $< 100 \mu\text{A}$

## AC/DC Multi-voltage Input Model



**Note:** Select input transistors according to the following:  
Dielectric strength of the collector  $\geq 50$  V  
Leakage current  $< 1 \mu\text{A}$

## No-voltage Input Model

### 1. Contact Input (Input by a Relay or Switch Contact)



**Note:** Use Relays and Switches that have high contact reliability because the current flowing from terminals 1 or 3 is small. It is recommended that OMRON's G3TA-1A/ID be used as the SSR.

### 2. Solid-state Input (Open Collector Input of an NPN Transistor)



**Note:** 1. Residual voltage in the output section of Proximity Sensors or Photoelectric Sensors becomes less than 0.5 V because the current flowing from terminals 1 or 3 is small thus allowing easy connection.

2. Select input transistors according to the following:  
Dielectric strength of the collector  $\geq 50$  V  
Leakage current  $< 1 \mu\text{A}$

# Operation

## ■ Operating Modes

### H7EC Total Counter

Incrementing Operation (Up)



## Nomenclature

Front view

Reset Key

Reset the count value. Not operable under key-protect.

Counting speed switch

For all models except for H7EC-NFV-□. If the counting speed setting is changed, the present value will not be held and so press the Reset Key on the front panel.

Setting (see note)	Counting speed
 Concave side	30 Hz (default setting)
 Concave side Terminal block	1 kHz

Key-protect Switch

The Reset Key is not operable while the key-protect switch is set to ON.

Setting (see note)	Key-protect
 Concave side	OFF (default setting)
 Concave side Terminal block	ON

Bottom view

**Note:** Perform switch setting before mounting to a control panel.

# Dimensions

**Note:** All units are in millimeters unless otherwise indicated.

## H7EC-N



### Panel Cutout

Separate mounting



Dense mounting



Waterproofing is not possible for dense mounting

## Dimensions with Y92F-34 Flush Mounting Bracket

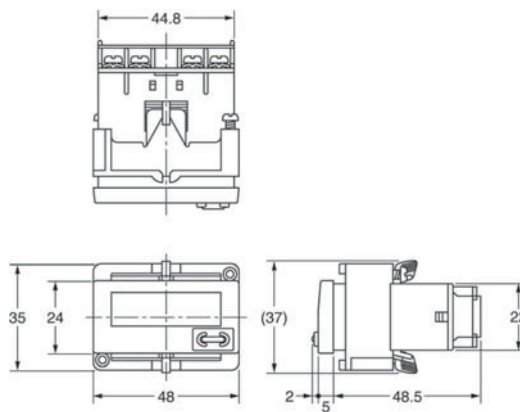

- When mounting, insert the Counter into the cutout, insert the adapter from the back and push in the Counter while making the gap between the front panel and the cutout panel as small as possible. Use screws to secure the Counter. If waterproofing is desired, insert the waterproof packing.
- When several Counters are installed, ensure that the ambient temperature will not exceed specifications.
- The appropriate thickness of the panel is 1 to 5 mm.

**Note:** A Compact Flush Mounting Bracket (Y92F-35) can also be used. Refer to *Accessories* for details.



# Self-powered Time Counter New H7ET

- Seven digits, time range 0 to 3999d23.9h.
- Dual time range: 999999.9 ↔ 3999d23.9h or 999h59m59s ↔ 9999h59.9m



## Model Number Structure

### Model Number Legend

Note: Some configurations are not available.

H7ET - N   -

1    2        3    4

#### 1. Count Input

- None: No-voltage input
- V: PNP/NPN universal DC voltage input
- FV: AC/DC multi-voltage input

#### 2. Time Range

- None: 999999.9h/3999d23.9h
- 1: 999h59m59s/9999h59.9m

#### 3. Case Color

- None: Light gray
- B: Black

#### 4. Display

- None: 7-segment LCD without backlight
- H: 7-segment LCD with backlight

## Ordering Information

### Time Counters

Timer input	Display	Time range			
		999999.9h ↔ 3999d23.9h (switchable)		999h59min59s ↔ 9999h59.9min (switchable)	
		Light-gray body	Black body	Light-gray body	Black body
PNP/NPN universal DC voltage input (4.5 to 30 VDC)	7-segment LCD with backlight	H7ET-NV-H	H7ET-NV-BH	H7ET-NV1-H	H7ET-NV1-BH
	7-segment LCD	H7ET-NV	H7ET-NV-B	H7ET-NV1	H7ET-NV1-B
AC/DC multi-voltage input (24 to 240 VAC/VDC)	7-segment LCD	H7ET-NFV	H7ET-NFV-B	H7ET-NFV1	H7ET-NFV1-B
No-voltage input	7-segment LCD	H7ET-N	H7ET-N-B	H7ET-N1	H7ET-N1-B

### Accessories (Order Separately)

Name	Model
Compact Flush Mounting Bracket	Y92F-35
Flush Mounting Bracket (See note 1)	Y92F-34
Wire-wrap Terminal (set of two terminals)	Y92S-37
Lithium Battery (See note 2)	Y92S-36
Waterproof Packing (See note 1)	Y92S-32

Note: 1. Provided with H7ET. (Order additional Brackets separately as required.)

2. Built into H7ET. Order replacements using the above model number before the service life expires.

# Specifications

## ■ General

Item	H7ET-NV-□ H7ET-NV-□H	H7ET-NFV-□	H7ET-N-□	H7ET-NV1-□ H7ET-NV1-□H	H7ET-NFV1-□	H7ET-N1-□
Operating mode	Accumulating					
Mounting method	Flush mounting					
External connections	Screw terminals					
Reset	External/Manual reset					
Display	7-segment LCD with or without backlight, zero suppression (character height: 8.6 mm) (see note 1)					
Number of digits	7					
Time range	0.0h to 999999.9h ↔ 0.0h to 3999d23.9h (switchable with switch)			0s to 999h59min59s ↔ 0.0min to 9999h59.9min (switchable with switch)		
Timer input	PNP/NPN universal DC voltage input	AC/DC multi-voltage input	No-voltage input	PNP/NPN universal DC voltage input	AC/DC multi-voltage input	No-voltage input
Case color	Light gray or black (-B models)					
Attachment	Waterproof packing, Y92F-34 Flush Mounting Bracket, time unit labels (see note 2)					
Approved standard	UL863, CSA C22.2 No.14, Lloyds Conforms to EN61010-1/IEC61010-1 (pollution degree2/overvoltage category III) Conforms to VDE0106/P100					

Note: 1. Only PNP/NPN universal DC voltage input models (-H models) have a backlight.

2. "-hours", "-d-h", "-h-m", and "-h-m-s" labels are included.

## ■ Ratings

Item	H7ET-NV-□-□ H7ET-NV-□-□H	H7ET-NFV-□-□	H7ET-N-□-□
Supply voltage	Backlight model: 24 VDC (0.3 W max.) (for backlight) No-backlight model: Not required (powered by built-in battery)	Not required (powered by built-in battery)	
Timer input	High (logic) level: 4.5 to 30 VDC Low (logic) level: 0 to 2 VDC (Input impedance: Approx. 4.7 kΩ)	High (logic) level: 24 to 240 VAC/VDC, 50/60 Hz Low (logic) level: 0 to 2.4 VAC/VDC, 50/ 60 Hz	No voltage input Maximum short-circuit impedance: 10 kΩ max. Short-circuit residual voltage: 0.5 V max. Minimum open impedance: 750 kΩ min.
Reset input		No voltage input Maximum short-circuit impedance: 10 kΩ max. Short-circuit residual voltage: 0.5 V max. Minimum open impedance: 750 kΩ min.	
Minimum pulse width	1 s		
Reset system	External reset and manual reset: Minimum signal width of 20 ms		
Terminal screw tightening torque	0.98 N·m max.		
Ambient temperature	Operating: -10°C to 55°C (with no condensation or icing) Storage: -25°C to 65°C (with no condensation or icing)		
Ambient humidity	Operating: 25% to 85%		



# Connections

## Terminal Arrangement

Bottom view: View of the Time Counter rotated horizontally 180°

Backlight Model



No-backlight Model

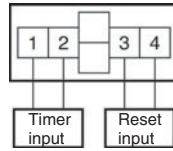

## Connections

### H7ET Time Counter

#### PNP/NPN Universal DC Voltage Input Model With Backlight

1. Contact Input (Input by a Relay or Switch Contact)
2. Solid-state Input

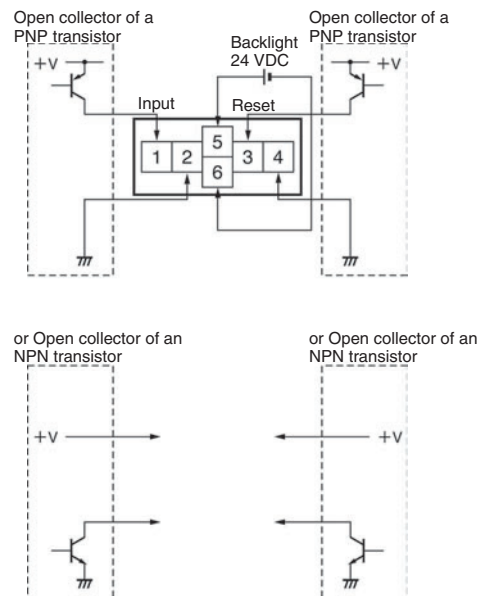

- Note:**
1. Terminals 2 and 4 (input circuit and reset circuit) are functionally isolated.
  2. Select input transistors according to the following:  
 Dielectric strength of the collector  $\geq 50$  V  
 Leakage current  $< 1 \mu\text{A}$

## PNP/NPN Universal DC Voltage Input Model Without Backlight

### 1. Contact Input (Input by a Relay or Switch Contact)



### 2. Solid-state Input

Open collector of a PNP transistor



Open collector of a PNP transistor

or Open collector of an NPN transistor



or Open collector of an NPN transistor

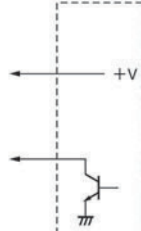

**Note:** 1. Terminals 2 and 4 (input circuit and reset circuit) are functionally isolated.

2. Select input transistors according to the following:  
Dielectric strength of the collector  $\geq 50$  V  
Leakage current  $< 1 \mu\text{A}$

## AC/DC Multi-voltage Input Model



or Open collector of an NPN transistor

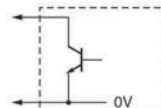

## No-voltage Input Model

### 1. Contact Input (Input by a Relay or Switch Contact)



**Note:** Use Relays and Switches that have high contact reliability because the current flowing from terminals 1 or 3 is as small as approx.  $10 \mu\text{A}$ . It is recommended that OMRON's G3TA-IA/ID be used as the SSR.

### 2. Solid-state Input

(Open Collector Input of an NPN Transistor)



**Note:** 1. Residual voltage in the output section of Proximity Sensors or Photoelectric Sensors becomes less than 0.5 V because the current flowing from terminals 1 or 3 is as small as approx.  $10 \mu\text{A}$ , thus allowing easy connection.

2. Select input transistors according to the following:  
Dielectric strength of the collector  $\geq 50$  V  
Leakage current  $< 1 \mu\text{A}$

# Operation

## ■ Operating Modes

### H7ET Time Counter

Incrementing Operation (Up)



## Nomenclature



### Reset Key

Reset the count value. Not operable under key-protect.

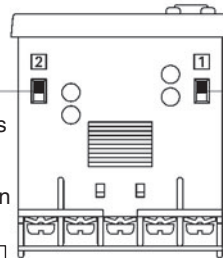

### Time-range switch

If the time-range setting is changed, the present value will not be held and so press the Reset Key on the front panel.

### Key-protect Switch

The Reset Key is not operable while the key-protect switch is set to ON.

Setting (see note)	Time range	
	H7ET-N□□-□□	H7ET-N□□1-□□
Front panel ↑ 	0.0h to 3999d23.9h	0s to 999h59min59s (default setting)
Terminal block ↓ 	0.0h to 999999.9h (default setting)	0.0min to 9999h59.9min

Setting (see note)	Key-protect
Front panel ↑ 	OFF (default setting)
Terminal block ↓ 	ON

**Note:** Perform switch setting before mounting to a control panel.

# Dimensions

**Note:** All units are in millimeters unless otherwise indicated.

## H7ET-N



## Dimensions with Y92F-34 Flush Mounting Bracket

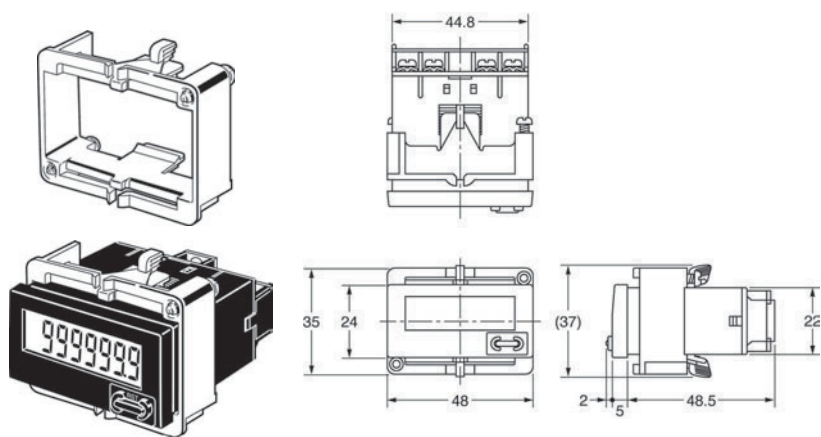

### Panel Cutout

Separate mounting



Dense mounting

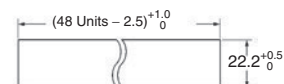

Waterproofing is not possible for dense mounting

- When mounting, insert the Counter into the cutout, insert the adapter from the back and push in the Counter while making the gap between the front panel and the cutout panel as small as possible. Use screws to secure the Counter. If waterproofing is desired, insert the waterproof packing.
- When several Counters are installed, ensure that the ambient temperature will not exceed specifications.
- The appropriate thickness of the panel is 1 to 5 mm.

**Note:** A Compact Flush Mounting Bracket (Y92F-35) can also be used. Refer to *Accessories* for details.

# Self-powered Tachometer New H7ER

- Revolutions displayed up to five digits.
- Dual revolution display according to encoder resolution used; 1000 s<sup>-1</sup>/1000 min<sup>-1</sup> or 1000.0 s<sup>-1</sup> /1000.0 min<sup>-1</sup>
- Switchable dual revolution display type available (-NV1 models); extended up to 10000 min<sup>-1</sup>



## Model Number Structure

### Model Number Legend

Note: Some configurations are not available.

H7ER - N   -

1    2        3    4

#### 1. Count Input

- None: No-voltage input
- V: PNP/NPN universal DC voltage input

#### 2. Number of Digits

- None: 4 digits
- 1: 5 digits

#### 3. Case Color

- None: Light gray
- B: Black

#### 4. Display

- None: 7-segment LCD without backlight
- H: 7-segment LCD with backlight

## Ordering Information

### Tachometers

Count input	Display	Max. revolutions displayed (applicable encoder resolution)			
		1000 s <sup>-1</sup> (1 pulse/rev.), 1000 min <sup>-1</sup> (60 pulse/rev.)		1000.0 s <sup>-1</sup> (10 pulse/rev.), 1000.0 min <sup>-1</sup> (600 pulse/rev.) ↔ 10000 min <sup>-1</sup> (60 pulse/rev.) (switchable)	
		Light-gray body	Black body	Light-gray body	Black body
PNP/NPN universal DC voltage input (4.5 to 30 VDC)	7-segment LCD with backlight	H7ER-NV-H	H7ER-NV-BH	H7ER-NV1-H	H7ER-NV1-BH
	7-segment LCD	H7ER-NV	H7ER-NV-B	H7ER-NV1	H7ER-NV1-B
No-voltage input	7-segment LCD	H7ER-N	H7ER-N-B	---	---

### Accessories (Order Separately)

Name	Model
Compact Flush Mounting Bracket	Y92F-35
Flush Mounting Bracket (See note 1)	Y92F-34
Wire-wrap Terminal (set of two terminals)	Y92S-37
Lithium Battery (See note 2)	Y92S-36
Waterproof Packing (See note 1)	Y92S-32

Note: 1. Provided with H7ER. (Order additional Brackets separately as required.)

2. Built into H7ER. Order replacements using the above model number before the service life expires.



# Specifications

## General

Item	H7ER-NV-□ H7ER-NV-□H	H7ER-N-□	H7ER-NV1-□ H7ER-NV1-□H
Operating mode	Up type		
Mounting method	Flush mounting		
External connections	Screw terminals, Wire-wrap Terminals (see note 3)		
Display	7-segment LCD with or without backlight, zero suppression (character height: 8.6 mm) (see note 4)		
Number of digits	4		5
Count input	PNP/NPN universal DC voltage input	No-voltage input	PNP/NPN universal DC voltage input
Max. counting speed	1 kHz		10 kHz
Max. revolutions displayed (see note 5)	1,000 s <sup>-1</sup> (When encoder resolution of 1 pulse/rev is used.) 1,000 min <sup>-1</sup> (When encoder resolution of 60 pulse/rev is used.)		1,000.0 s <sup>-1</sup> (When encoder resolution of 10 pulse/rev is used.) 1,000.0 min <sup>-1</sup> (When encoder resolution of 600 pulse/rev is used.) ↔ 10,000 min <sup>-1</sup> (When encoder resolution of 60 pulse/rev is used.) (Switchable with switch)
Attachment	Waterproof packing, Y92F-34 Flush Mounting Bracket, revolution unit labels (see note 5)		
Approved standard	UL863, CSA C22.2 No.14, Lloyds Conforms to EN61010-1/IEC61010-1 (Pollution degree2/overvoltage category III) Conforms to VDE0106/P100		

- Note:**
- Reset is not available.
  - When there is no input, the display will be 0.0 or 0.
  - Separately ordered Wire-wrap Terminals (Y92S-37) are required.
  - Only PNP/NPN Universal DC voltage input models have a backlight.
  - "rpm", "rps", "s<sup>-1</sup>" and "min<sup>-1</sup>" labels are included.

## Ratings

Item	H7ER-NV-□-□ H7ER-NV-□-□H	H7ER-N-□
Supply voltage	Backlight model: 24 VDC (0.3 W max.) (for backlight lit) No-backlight model: Not required (powered by built-in battery)	Not required (powered by built-in battery)
Count input	High (logic) level: 4.5 to 30 VDC Low (logic) level: 0 to 2 VDC (Input impedance: Approx. 4.7 kΩ)	No voltage input Maximum short-circuit impedance: 10 kΩ max. Short-circuit residual voltage: 0.5 V max. Minimum open impedance: 750 kΩ min.
Max. counting speed	4-digit models: 1 kHz 5-digit models: 10 kHz	1 kHz
Minimum signal width	10 kHz: 0.05 ms 1 kHz: 0.5 ms (See note.)	
Terminal screw tightening torque	0.98 N·m max.	
Ambient temperature	Operating: -10°C to 55°C (with no condensation or icing) Storage: -25°C to 65°C (with no condensation or icing)	
Ambient humidity	Operating: 25% to 85%	

**Note:** 5-digit models : 1 kHz/10 kHz switchable.



# Connections

## Terminal Arrangement

Bottom view: View of the Tachometer rotated horizontally 180°

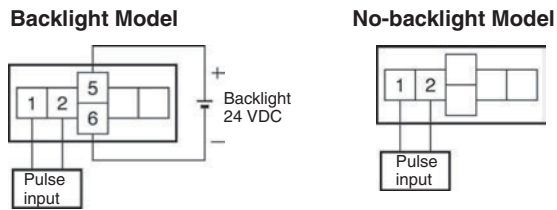

## Connections

### H7ER Tachometer

**Note:** Select input transistors according to the following:  
 Dielectric strength of the collector  $\geq 50$  V  
 Leakage current  $< 100 \mu\text{A}$  ( $1 \mu\text{A}$  for no-voltage input model)

#### PNP/NPN Universal DC Voltage Input Models With Backlight Transistor Input



#### No-voltage Input Model Transistor Input (Open Collector of an NPN Transistor)

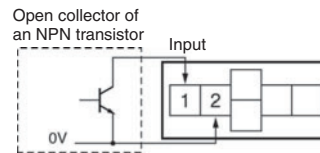

#### PNP/NPN Universal DC Voltage Input Models Without Backlight Transistor Input



# Operation

## ■ Operating Modes

### H7ER Tachometer

Incrementing Operation  
Within Unit Time (Up)

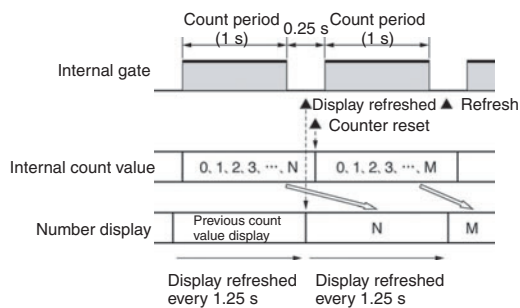

## Nomenclature



### Counting Speed Switch Settings and Unit Label Application

Model	Counting speed switch setting (see note)	Max. revolutions displayed	Applicable encoder resolution	Applicable unit label
H7ER-NV1-□□	Front panel ↑ Concave side	10000 min <sup>-1</sup> (default setting)	60 pulse/rev.	"min <sup>-1</sup> " or "rpm"
	↓ Concave side	1000.0 min <sup>-1</sup>	600 pulse/rev.	"min <sup>-1</sup> " or "rpm"
	Terminal block	1000.0 s <sup>-1</sup>	10 pulse/rev.	"s <sup>-1</sup> " or "rps"
H7ER-N-□ H7ER-NV-□□	No setting is required	1000 min <sup>-1</sup>	60 pulse/rev.	"min <sup>-1</sup> " or "rpm"
		1000 s <sup>-1</sup>	1 pulse/rev.	"s <sup>-1</sup> " or "rps"

**Note:** Perform switch setting before mounting to a control panel.

# Dimensions

**Note:** All units are in millimeters unless otherwise indicated.

## H7ER-N



### Panel Cutout

Separate mounting



Dense mounting

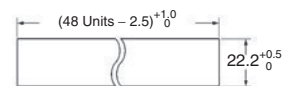

Waterproofing is not possible for dense mounting

## Dimensions with Y92F-34 Flush Mounting Bracket

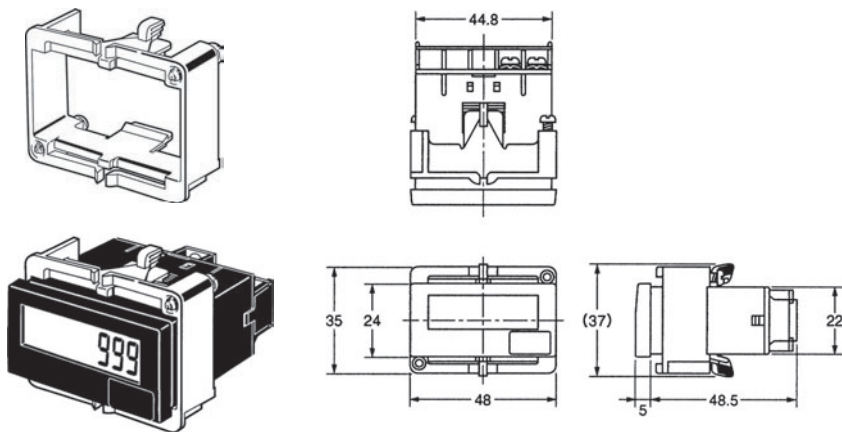

- When mounting, insert the Counter into the cutout, insert the adapter from the back and push in the Counter while making the gap between the front panel and the cutout panel as small as possible. Use screws to secure the Counter. If waterproofing is desired, insert the waterproof packing.
- When several Counters are installed, ensure that the ambient temperature will not exceed specifications.
- The appropriate thickness of the panel is 1 to 5 mm.

**Note:** A Compact Flush Mounting Bracket (Y92F-35) can also be used. Refer to *Accessories* for details.

# PCB-mounting Counters H7E□-N□P

- Dedicated for use on PCB.
- Total Counters and Time Counter available.

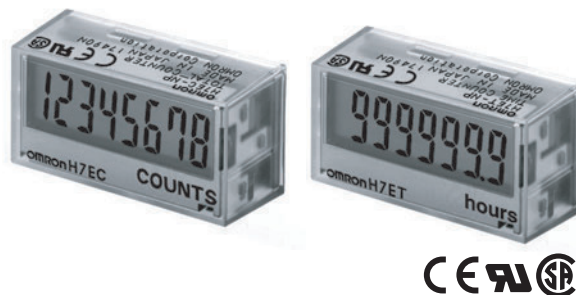

## Model Number Structure

### Model Number Legend

H7E□-N□P  
1 2

#### 1. Function

C: Total Counter  
T: Time Counter

#### 2. Max. Counting Speed for H7EC Models

None: 1 kHz  
L: 30 Hz

## Ordering Information

### PC Board-use Counters

Count input	Display	Total counter		Time counter
		Max. counting speed		
		1 kHz	30 Hz	
No-voltage input	7-segment LCD	H7EC-NP	H7EC-NLP	H7ET-NP

### Accessory (Order Separately)

Connecting Socket (28-pin)	XR2A-2801-N
----------------------------	-------------

# Specifications

## ■ General

Item	Total Counter		Time Counter
	H7EC-NP	H7EC-NLP	H7ET-NP
Operating mode	Up type		
Mounting method	Direct mounting on PC Board or mounting on 28-pin socket		
Reset	External reset, Power-OFF reset		
Number of digits	8		7
Time range	---		0.0h to 999999.9h
Max. counting speed	1 kHz	30 Hz	---
Count/Timer input	No-voltage input		
Display	7-segment LCD (character height: 8.6 mm)		
Case color	Transparent		
Approved standard	UL863, CSA C22.2 No.14		

## ■ Ratings

Item	H7EC-NP H7EC-NLP	H7ET-NP
Supply voltage	3 VDC (2.7 to 3.3 VDC)	
Count/Timer input	No voltage input	
Reset input	Maximum short-circuit impedance: 10 kΩ max. Short-circuit residual voltage: 0.5 V max. Minimum open impedance: 750 kΩ min.	
Max. counting speed (see note)	1 kHz: Minimum signal width of 0.5 ms 30 Hz: Minimum signal width of 16.7 ms	---
Minimum signal input width	---	1 s
Reset system	External reset: Minimum signal width of 20 ms Power-OFF reset: Minimum power OFF time of 500 ms	
Ambient temperature	Operating: -10°C to 55°C (with no condensation or icing) Storage: -25°C to 65°C (with no condensation or icing)	
Ambient humidity	Operating: 25% to 85%	

Note: ON/OFF ratio 1:1

## ■ Characteristics

Item	H7EC-NP H7EC-NLP	H7ET-NP
Time accuracy	---	±100 ppm (25°C)
Noise immunity	Square-wave noise generated by noise simulator (pulse width: 100 ns/1 μs, 1-ns rise) ±500 V (Between count or timer input terminals/Between reset terminals)	
Static immunity	±8 kV (malfunction)	
Vibration resistance	Malfunction:0.15-mm single amplitude at 10 to 55 Hz for 10 min each in 3 directions Destruction:0.375-mm single amplitude at 10 to 55 Hz for 2 hrs each in 3 directions	
Shock resistance	Malfunction:200 m/s <sup>2</sup> 3 times each in 6 directions Destruction:300 m/s <sup>2</sup> 3 times each in 6 directions	
EMC	(EMI) EN61326 Emission Enclosure: EN55011 Group 1 class B (EMS) EN61326 Immunity ESD: EN61000-4-2: 4-kV contact discharge (level 2) 8-kV air discharge (level 3) Immunity RF-interference from AM Radio Waves: EN61000-4-3: 10 V/m (80 MHz to 1 GHz) (level 3) Immunity RF-interference from Pulse-modulated Radio Waves: EN61000-4-3: 10 V/m (900 MHz ± 5 MHz) (level 3) Immunity Conducted Disturbance (see note):EN61000-4-6: 10 V (0.15 to 80 MHz) (level 3) Immunity Burst (see note): EN61000-4-4: 2-kV I/O signal line (level 4)	
Weight	Approx. 20 g	

Note: The power supply terminals of the H7E□-N□P are considered as 3-VDC control terminals.

# Connections

## Terminal Arrangement

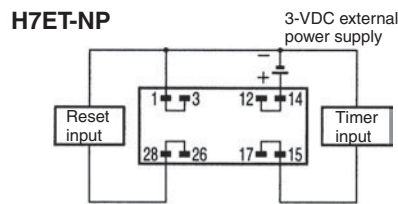
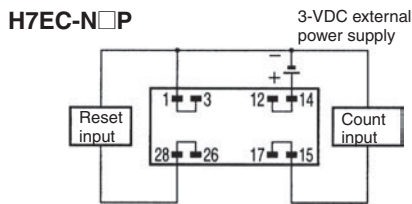

## Connections

### Power Supply and Battery Connections

#### Battery Connections



When designing a circuit, keep the power wiring connections shorter than 50 mm. Refer to the connection diagram above for the proper wiring polarity.

The life expectancy of a battery power supply can be calculated by the following formula:

$$t = A / I_c$$

Where,

t: Life expectancy of battery (h)

A: Battery capacity (mAh)

I<sub>c</sub>: H7E□-N□P current consumption (mA)

Example:

Battery life when using a 3-V lithium battery with a capacity of 1,200 mAh for the H7E□-N□P.

$$t = 1,200 \text{ [mAh]} / 20 \times 10^{-3} \text{ [mA]} = 60,000 \text{ hours (approx. 6.8 years)}$$

The battery capacity varies depending on the type of battery used; oxidized silver, mercury, or lithium battery.

#### Voltage Division of Power Supply Circuit

When necessary, the voltage from the battery may be divided by resistances:

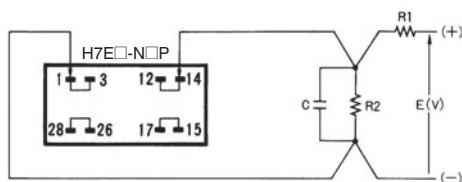

When doing so, however, ensure that the following equation balances:

$$E(V) \times R_2 / (R_1 + R_2) = 3 V$$

R	E		
	5 V	12 V	24 V
R <sub>1</sub>	2 kΩ	9.1 kΩ	33 kΩ
R <sub>2</sub>	3 kΩ	3 kΩ	4.7 kΩ

Allow a current high enough to flow through R<sub>1</sub> so that the H7E□-N□P receives sufficient current.

C is a film capacitor, of about 0.1 μF, and is intended to absorb noise induced by the power lines.

Keep the wiring between the H7E□-N□P and R<sub>2</sub> or C as short as possible (within 50 mm).

#### Backup Circuit for Protection Against Power Failure



Use a diode (D) having a forward voltage as small as possible (0.1 V max. at I<sub>F</sub> of 20 μA).

Determine the ratio of R<sub>1</sub> to R<sub>2</sub> in accordance with the forward voltage of the diode to be used. Be aware that when the power supplied to the H7E□-N□P has dropped to less than the voltage of the backup circuit, the battery will discharge.

To protect the circuit against a momentary power failure, an aluminum electrolyte capacitor can be used in place of a battery, as shown below:



When a capacitor is used, its backup time can be calculated by the following formula:

$$t = C(V_1 - V_2) / I_c$$

Where,

t: Backup time (s)

C: Capacitance (μF)

V<sub>1</sub>: Supply voltage before power failure (V)

V<sub>2</sub>: Minimum operating voltage of H7E□-N□P (V)

I<sub>c</sub>: H7E□-N□P current consumption (μA)

Example:

Backup time by an aluminum electrolytic capacitor of 100 μF. (Minimum operating voltage of H7E□-N□P is 2.6 V.)

$$t = 100 \mu\text{F} \times (3 - 2.6 \text{ V}) / 20 \mu\text{A} = 100 \times 0.40 / 20 = 2.0 \text{ seconds}$$

Note that the above calculation provides an approximate value, which varies depending on the environment under which the Counter is used and also on the type of capacitors used. Provide some allowance in selecting capacitors.

Keep the wiring between the H7E□-N□P and R<sub>2</sub> or C as short as possible (within 50 mm).



## Input Connections

### Input Connection Contact Input



When the H7EC-NP is used, relay chattering may be counted. Use the H7EC-NLP, one of the low-speed input models.

### Solid State Input

#### Open-collector Transistor Input



#### TTL or C-MOS IC Input

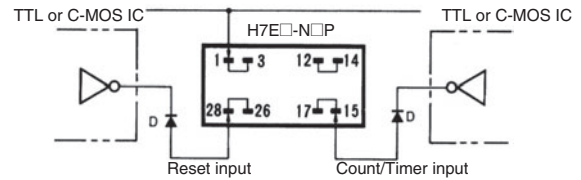

Use a transistor for input that satisfies the following conditions:

Collector breakdown voltage  $\geq 50$  V

Leakage current  $< 1 \mu\text{A}$

Use a diode (D) having a forward voltage as small as possible (0.1 V max. at  $I_F$  of 20  $\mu\text{A}$ ).

## Operation

### Operating Modes

#### H7EC Total Counter

Incrementing Operation (Up)



#### H7ET Time Counter

Incrementing Operation (Up)



# Dimensions

Note: All units are in millimeters unless otherwise indicated.

## H7EC-N□P



## DIP Terminal



## PCB Processing Dimensions (Soldering Surface)



Note: Processing dimensions are for 28-pin IC socket.

## H7ET-NP

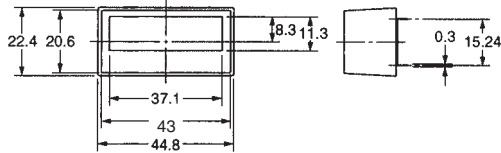

# Accessories (Order Separately) (Common)

## ■ New H7E (Except for PCB-mounting Counter)

The New H7E models are supplied with a mounting bracket (Y92F-34) and nut. Additionally, the Y92F-75/-76/-77B Flush Mounting Adapters shown here allow the New H7E models to be fitted to existing panel cutouts.

### Y92F-35 Compact Flush Mounting Bracket



### Panel Cutout

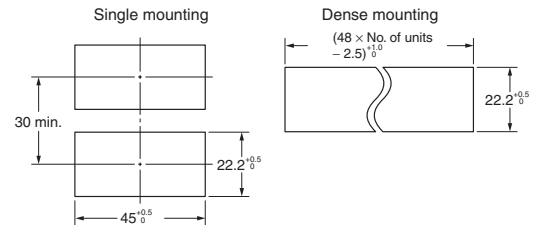

Degree of protection (front): IP40 (not waterproof)  
The DIP switch of the H7E□-N can be operated in mounted condition. Vibration resistance and shock resistant are the same level as the H7E□-N series.

- The minimum mounting interval is 30 mm.  
Note: An interval of 40 mm is recommended for easier wiring.
- Do not allow the ambient temperature of the H7E□-N to exceed the specifications (55°C).
- Mounting is possible onto panels with a thickness of 1 to 5 mm.

### Y92F-75 Flush Mounting Adapter for 26 × 45.3 Rectangular Cutout

Use mounting bracket supplied with the Counter

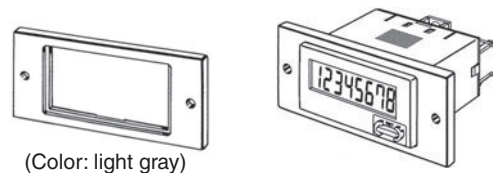

### Panel Cutout

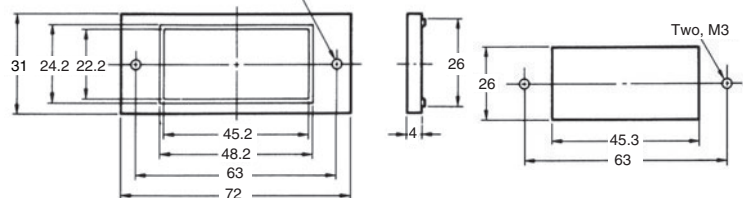

### Y92F-76 Flush Mounting Adapter for 27.5 × 52.5 Rectangular Cutout

Use the Y92F-76 together with the Y92F-35 Compact Flush Mounting Bracket.  
Do not use the Flush Mounting Adapter supplied with the Counter.

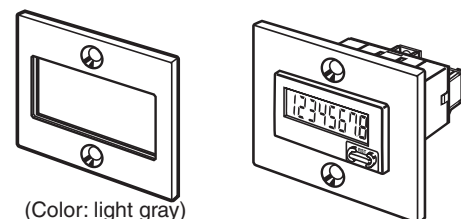

### Panel Cutout

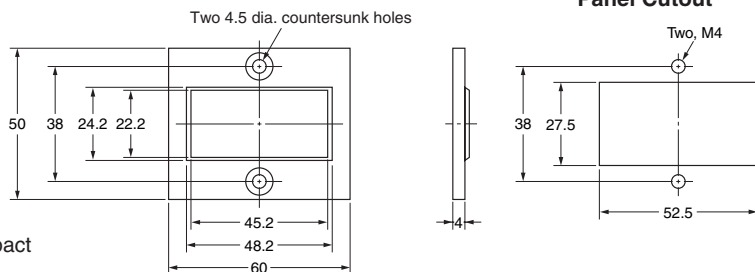

### Y92F-77B Flush Mounting Adapter for 24.8 × 48.8 Rectangular Cutout

Use mounting bracket supplied with the Counter

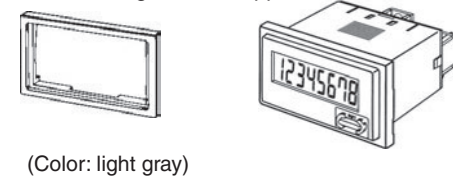

### Panel cutout

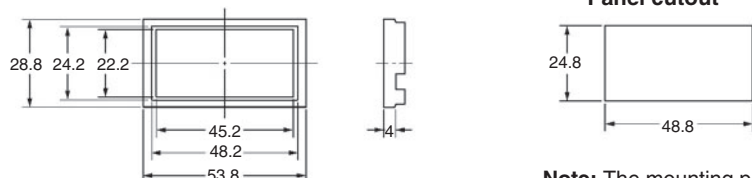

**Note:** The mounting panel thickness should be between 1 and 5 mm.

**Y92S-37 Wire-wrap Terminal (Set of Two Terminals)**



When using the Wire-wrap Terminal, be sure to use the correct wires and peripheral devices. (The correct wires, bits and sleeves are shown in the table on the right.)

Wire	Bit	Sleeve	Wrapped state
AWG22	2-A	2-B	Normal
AWG24	1-A	1-B	Normal
AWG26	3-A	1-B	Normal

**Y92S-36 Lithium Battery (3 V)**



## Precautions (Common)

Refer to *Safety Precautions for All Counters*.

### ■ New H7E (Except for PCB-mounting Counter)

#### ⚠ WARNING

This product has a built-in lithium battery. Do not short-circuit the + and – terminals, charge, disassemble, deform, or expose the battery to fire. The battery may explode (break), catch fire, or cause liquid leakage.

Do not use any battery other than the specified one (Y92S-36). Using another battery may cause liquid leakage or breakage, resulting in malfunction or injury.

#### ⚠ CAUTION

If a voltage other than the rated one is applied, internal elements may be damaged.

Do not use the Counter in the following places:

- Locations subject to direct sunlight.
- Locations subject to corrosive gases.
- Locations subject to dust.

### Before Use

- An insulation sheet has been inserted to maintain the quality of the Totalizer in the event of a long period without use. Be sure to remove this sheet before attempting to use the product.

Remove the insulation sheet and press the Reset Key on the front panel of the Counter. (With the H7ER-N, -NV(-H), -NV1(-H), models, "0" or "0.0" will be displayed after 1 s.)

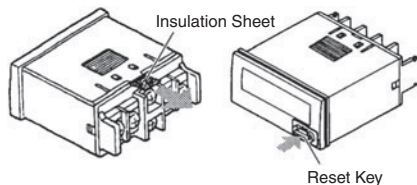

- Switch settings on the Counter must be performed before mounting it to a control panel.
- Do not use the Counter in the following locations:
  - Locations subject to severe changes in temperature.
  - Locations subject to condensation as the result of high humidity.

### Mounting Precautions for Flush Mounting

Although the operating section is watertight (conforming to NEMA4, IP66), rubber packing is provided to avoid water leakage through the gap between the Counter and panel cutout. Unless this rubber packing is tightly squeezed on, water may permeate inside the panel. Therefore, be sure to tighten the screws for fixing the Y92F-34 Flush Mounting Bracket. (Excessive tightening may also deform the rubber packing.)

#### Screw for the Flush Mounting Bracket



### Reset Input and Count/Timer Input

- The H7E operates using its built-in Battery. If the H7E is connected to a device that has +V and OUT terminals that are connected with a diode as shown in the circuit diagram, the circuit indicated by the arrow 1 or 2 will be formed when the device is turned OFF. As a result, the H7E may be reset or count by one. It is recommended that such devices not be connected to the H7E.



- If an excessive voltage is applied to the count/timer input or reset terminals, the internal elements may be damaged. Ensure that the following voltages are not exceeded:
  - PNP/NPN universal voltage input model: 30 VDC
  - AC/DC voltage input model:
    - At count/timer input: 240 VAC (peak voltage: 338V)
    - 240 VDC
    - At reset input: No voltage can be applied. (No-voltage input)
  - No-voltage input model: No voltage can be applied.
- Avoid wiring close to high-tension or large-current lines.
- Do not remove the outer case when voltage is being applied to the power supply terminals or the input terminals.
- The input for the H7E□-NFV-□ is a high-impedance circuit and so influence from an induced voltage may result in malfunction. Therefore, when the input signal wiring is longer than 10 m (line capacitance of 120 pF/m, at room temperature), it is recommended that a CR filter or a bleeder resistor is connected.

## Count Input, Timer Input or Reset Input to More than One H7E Counter at a Time

- PNP/NPN Universal DC Voltage Input



**Note:** H (Reset ON) level must be 4.5 V minimum.

$$H = \frac{4.7 (k\Omega)/N + V}{4.7 (k\Omega)/N + R}$$

- No-voltage Input

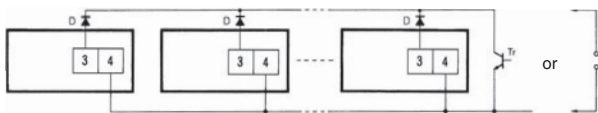

- Note:**
1. The leakage current of the transistor used for input must be less than 1  $\mu$ A.
  2. The forward voltage of the diode must be as low as possible (i.e., 0.1 V maximum with an  $I_F$  of 20  $\mu$ A) so that the voltage between terminals 3 and 4 will be 0.5 V when the reset input is ON.

## Input and Power Supply

### No-voltage Input Models

- Do not impose voltage on the Counter if the Counter is a model that operates with no-voltage input, otherwise the internal circuit of the Counter may be damaged. Do not connect any single input signal in parallel to Counter models operating with no-voltage input and those operating with voltage input, otherwise the Counters may malfunction.
- When connecting a sensor to the Counter that operates with no-voltage input, make sure that the sensor has open collector output.



- When connecting an open collector input from a transistor to the Counter that operates with no-voltage input, make sure that the leakage current of the transistor is 1  $\mu$ A maximum.

### No-voltage Input and PNP/NPN Universal DC Voltage Input Models

- The operation of the Counter may be affected if the capacitance of input lines exceeds 500 pF (about 10 m, with parallel wires of 2 x 2 mm). Keep all wires as short as possible. When using shielded wire, line capacitance may occur.

## AC/DC Multi-voltage Input Models

- When connecting count/timer input from an SSR to the Counter that operates with AC/DC voltage input, use OMRON's G3TA-IA/ID SSR (for DC) whose leakage current is 0.1 mA max. or connect a bleeder resistor in parallel to the input circuit of the Counter.



## Backlight Power Supply

- To reduce variation in the brightness of the backlight when using more than one H7E with a backlight, use the same power supply for all the backlights.



- When connecting the DC power supply for the backlights, be sure to connect the polarities correctly.

## Input Verification with the H7ET Time Counter

### (When the time range is not set to 0s to 999h59min59s)

The decimal point of the LCD blinks every other second while an input signal is being applied. If the decimal point is not blinking, the input signal is not being received correctly. Check the input signal connections.

## Unit Label for Time Counter and Tachometer

A unit label has been packed with the Counter. Use in accordance with the application.



## Battery Replacement

Remove the wiring when replacing the Battery. Do not come in contact with any item to which high voltage is being applied. Doing so may result in electric shock.

Before changing the Battery, the person should ensure that they are not carrying any static electric charge.

Procedure for replacing the Battery (refer to the diagrams below):

1. Using the tool, pry open the lift-tab on the case. (1)
2. Pull the body out of its outer case. (2)
3. Lift the Battery up by the edge and remove it. (3)  
When removing the Battery, do not come in contact with the display area or any internal parts.
4. Wipe the back of the new Battery before inserting it.
5. Ensure that the + and - terminals are correctly oriented.
6. After replacing the Battery, re-insert the body into its case. (4)  
Check that the case is securely held in by the lift-tab.

7. Press the Reset Key before use (not necessary for H7ER-N, -NV, -NV1). (5)



## EN/IEC Standards

The count or timer input, reset input, and backlight power supply terminals of the no-voltage input or PNP/NPN universal DC voltage input models (H7E□-N, -N1, H7E□-NV(-H), -NV1(-H)) are not isolated.

A SELV power supply conforming to Appendix H of IEC61010-1 should be used for the count or timer input, reset input and backlight power supply terminals. A SELV power supply is a power supply for which the input and output have double or reinforced insulation, and for which the output voltage is 30 Vrms with 42.4 V peak or 60 VDC max. (Only the H7E□-NV□-H has a backlight.)

The terminals for count or timer input and reset input for AC/DC multi-voltage input models have basic insulation.

Connect the reset input terminals to a device that does not have exposed current-carrying parts and has basic insulation for 240 VAC.

## Others

If the indicator keeps flickering or is OFF, the internal battery may be close to the end of its service life. In such a case, it is suggested that the battery be replaced.

## PCB-mounting Counter

### Power Supply

- Use the power supply within the applicable range indicated by the following waveform, while considering the ripple and voltage fluctuations of the circuit power source.



- The H7E□-N□P changes its mode as shown below depending on the applied supply voltage.



### Battery Replacement

To prevent unwanted reset when replacing the battery, connect the new battery before disconnecting the old one. Otherwise, the voltage supplied to the counter circuit drops, causing the present count value to reset.

When designing the circuit board, providing two extra terminals for battery connection will make the switch must simpler. See the schematic diagram below:



Wiring polarity must be carefully observed, in order to prevent permanent damage to the Counters. Exercise caution when inserting the Counter in the socket, to prevent reversed polarity.



## Inputs

Do not route the wiring of the count, timer, or reset inputs in the vicinity of, or in parallel to the wiring of high-voltage or inductive load circuits (such as motors and relays). Also, keep the wiring as short as possible.



Be careful not to apply voltages exceeding the following values to the count, timer, or reset terminals, otherwise the internal circuit may be damaged.

No-voltage input: 3 VDC

## General Information

Finish soldering under the conditions below.

Solder the terminals within 5 seconds, at a solder iron tip temperature of  $250^{\circ}\text{C} \pm 10^{\circ}\text{C}$  when using lead solder, and within 3 seconds, at a solder iron tip temperature of  $350^{\circ}\text{C} \pm 10^{\circ}\text{C}$  when using lead-free solder.

Since the Counter is not flux-tight, do not use flux when soldering.

Avoid automatic and dip soldering. Manually solder the Counter onto a PC board, and avoid cleaning as much as possible.

When mounting the Counter on a PC board with components which consume higher current than the H7E□-N□P, observe the following precautions.

1. Minimize the wiring (less than 50 mm) from the H7E□-N□P to the power supply section.
2. Avoid placing the H7E□-N□P power, timer, counter, or reset input circuit in parallel with circuits that consume large currents, particularly on the positive side.

PC Board (Bad Example)



PC Board (Good Example)



When using the Counter in an environment where the Counter is subject to frequent occurrences of vibration or shock, or when mounting the Counter facing downwards or sideways, it is suggested that the Counter be directly soldered to a PCB instead of using sockets.

## To Conform to EN/IEC Standards

Input terminals have no insulation from power supply terminals. The power supply terminals must be supplied from a SELV source in accordance with IEC61010-1 Annex H. SELV (separated extra-low voltage) source is a power supply having double or reinforced insulation between the primary and the secondary circuit and having output voltage of 30 V rms max. and 42.4 V peak max. or 60 VDC max.

## Cleaning

To prevent damage, the exterior of the Counter must not be exposed to organic solvents (3.g. paint thinner or benzene), strong alkalis, or strong acids.

## Others

- No user-serviceable parts.
- Return to OMRON for all repairs.

ALL DIMENSIONS SHOWN ARE IN MILLIMETERS.

To convert millimeters into inches, multiply by 0.03937. To convert grams into ounces, multiply by 0.03527.

In the interest of product improvement, specifications are subject to change without notice.



## Read and Understand This Catalog

Please read and understand this catalog before purchasing the products. Please consult your OMRON representative if you have any questions or comments.

## Warranty and Limitations of Liability

### WARRANTY

OMRON's exclusive warranty is that the products are free from defects in materials and workmanship for a period of one year (or other period if specified) from date of sale by OMRON.

OMRON MAKES NO WARRANTY OR REPRESENTATION, EXPRESS OR IMPLIED, REGARDING NON-INFRINGEMENT, MERCHANTABILITY, OR FITNESS FOR PARTICULAR PURPOSE OF THE PRODUCTS. ANY BUYER OR USER ACKNOWLEDGES THAT THE BUYER OR USER ALONE HAS DETERMINED THAT THE PRODUCTS WILL SUITABLY MEET THE REQUIREMENTS OF THEIR INTENDED USE. OMRON DISCLAIMS ALL OTHER WARRANTIES, EXPRESS OR IMPLIED.

### LIMITATIONS OF LIABILITY

OMRON SHALL NOT BE RESPONSIBLE FOR SPECIAL, INDIRECT, OR CONSEQUENTIAL DAMAGES, LOSS OF PROFITS OR COMMERCIAL LOSS IN ANY WAY CONNECTED WITH THE PRODUCTS, WHETHER SUCH CLAIM IS BASED ON CONTRACT, WARRANTY, NEGLIGENCE, OR STRICT LIABILITY.

In no event shall the responsibility of OMRON for any act exceed the individual price of the product on which liability is asserted.

IN NO EVENT SHALL OMRON BE RESPONSIBLE FOR WARRANTY, REPAIR, OR OTHER CLAIMS REGARDING THE PRODUCTS UNLESS OMRON'S ANALYSIS CONFIRMS THAT THE PRODUCTS WERE PROPERLY HANDLED, STORED, INSTALLED, AND MAINTAINED AND NOT SUBJECT TO CONTAMINATION, ABUSE, MISUSE, OR INAPPROPRIATE MODIFICATION OR REPAIR.

## Application Considerations

### SUITABILITY FOR USE

OMRON shall not be responsible for conformity with any standards, codes, or regulations that apply to the combination of products in the customer's application or use of the products.

At the customer's request, OMRON will provide applicable third party certification documents identifying ratings and limitations of use that apply to the products. This information by itself is not sufficient for a complete determination of the suitability of the products in combination with the end product, machine, system, or other application or use.

The following are some examples of applications for which particular attention must be given. This is not intended to be an exhaustive list of all possible uses of the products, nor is it intended to imply that the uses listed may be suitable for the products:

- Outdoor use, uses involving potential chemical contamination or electrical interference, or conditions or uses not described in this catalog.
- Nuclear energy control systems, combustion systems, railroad systems, aviation systems, medical equipment, amusement machines, vehicles, safety equipment, and installations subject to separate industry or government regulations.
- Systems, machines, and equipment that could present a risk to life or property.

Please know and observe all prohibitions of use applicable to the products.

NEVER USE THE PRODUCTS FOR AN APPLICATION INVOLVING SERIOUS RISK TO LIFE OR PROPERTY WITHOUT ENSURING THAT THE SYSTEM AS A WHOLE HAS BEEN DESIGNED TO ADDRESS THE RISKS, AND THAT THE OMRON PRODUCTS ARE PROPERLY RATED AND INSTALLED FOR THE INTENDED USE WITHIN THE OVERALL EQUIPMENT OR SYSTEM.

### PROGRAMMABLE PRODUCTS

OMRON shall not be responsible for the user's programming of a programmable product, or any consequence thereof.

## Disclaimers

### CHANGE IN SPECIFICATIONS

Product specifications and accessories may be changed at any time based on improvements and other reasons.

It is our practice to change model numbers when published ratings or features are changed, or when significant construction changes are made. However, some specifications of the products may be changed without any notice. When in doubt, special model numbers may be assigned to fix or establish key specifications for your application on your request. Please consult with your OMRON representative at any time to confirm actual specifications of purchased products.

### DIMENSIONS AND WEIGHTS

Dimensions and weights are nominal and are not to be used for manufacturing purposes, even when tolerances are shown.

### PERFORMANCE DATA

Performance data given in this catalog is provided as a guide for the user in determining suitability and does not constitute a warranty. It may represent the result of OMRON's test conditions, and the users must correlate it to actual application requirements. Actual performance is subject to the OMRON Warranty and Limitations of Liability.

### ERRORS AND OMISSIONS

The information in this document has been carefully checked and is believed to be accurate; however, no responsibility is assumed for clerical, typographical, or proofreading errors, or omissions.

2010.6

In the interest of product improvement, specifications are subject to change without notice.

**OMRON Corporation**  
Industrial Automation Company

<http://www.ia.omron.com/>

(c)Copyright OMRON Corporation 2010 All Right Reserved.

## Данный компонент на территории Российской Федерации

### Вы можете приобрести в компании MosChip.

Для оперативного оформления запроса Вам необходимо перейти по данной ссылке:

<http://moschip.ru/get-element>

Вы можете разместить у нас заказ для любого Вашего проекта, будь то серийное производство или разработка единичного прибора.

В нашем ассортименте представлены ведущие мировые производители активных и пассивных электронных компонентов.

Нашей специализацией является поставка электронной компонентной базы двойного назначения, продукции таких производителей как XILINX, Intel (ex.ALTERA), Vicor, Microchip, Texas Instruments, Analog Devices, Mini-Circuits, Amphenol, Glenair.

Сотрудничество с глобальными дистрибьюторами электронных компонентов, предоставляет возможность заказывать и получать с международных складов практически любой перечень компонентов в оптимальные для Вас сроки.

На всех этапах разработки и производства наши партнеры могут получить квалифицированную поддержку опытных инженеров.

Система менеджмента качества компании отвечает требованиям в соответствии с ГОСТ Р ИСО 9001, ГОСТ РВ 0015-002 и ЭС РД 009

### Офис по работе с юридическими лицами:

105318, г.Москва, ул.Щербаковская д.3, офис 1107, 1118, ДЦ «Щербаковский»

Телефон: +7 495 668-12-70 (многоканальный)

Факс: +7 495 668-12-70 (доб.304)

E-mail: [info@moschip.ru](mailto:info@moschip.ru)

Skype отдела продаж:

moschip.ru

moschip.ru\_4

moschip.ru\_6

moschip.ru\_9