

G6Z

Surface-mounting High-frequency Relay

Surface-mounting, 3-GHz-Band, Miniature, SPDT, High-frequency Relay

- Superior high-frequency characteristics, such as an isolation of 30 dB min., insertion loss of 0.5 dB max., and V.SWR of 1.5 max. at 2.6 GHz.
- Surface-mounting terminals and superior high frequency characteristics combined using semi triplate strip transmission lines.
- Miniature dimensions of 20 × 8.6 × 8.9 mm (L × W × H).
- Choose from a lineup that includes single-winding latching models (200 mW), double-winding latching models (360 mW), and models with a reverse contact arrangement.
- Series includes models with an E-shape terminal structure (same as existing models), and models with a Y-shape terminal structure, allowing greater freedom with PCB design.
- Models with 75-Ω impedance and models with 50-Ω impedance are available.

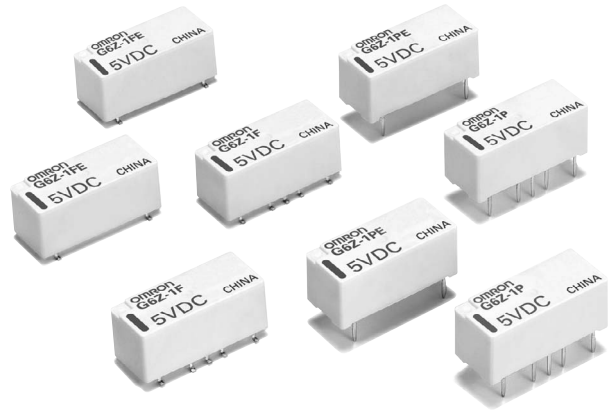

RoHS Compliant

Model Number Legend

G6Z□-□□□-□□
 1 2 3 4 5 6

1. Relay Function

- None: Single-side stable
- U: Single-winding latching
- K: Double-winding latching

2. Contact Form

- 1: SPDT (1c)

3. Terminal Shape

- F: Surface-mounting terminals
- P: PCB terminals

4. Terminal arrangement

- None: Y-shape terminal structure
- E: E-shape terminal structure

5. Characteristic Impedance

- None: 75 Ω
- A: 50 Ω

6. Contact Arrangement

- None: Standard contact arrangement
- R: Reverse contact arrangement

Application Examples

These Relays can be used for switching signals in media equipment.

- Wire communications: Cable TV (STB and broadcasting infrastructure), cable modems, and VRS (video response systems)
- Wireless communications: Transceivers, ham radios, car telephones, ETC, ITS, high-level TV, satellite broadcasting, text multiplex broadcasting, pay TV, mobile phone stations, TV broadcasting facilities, and community antenna systems
- Public equipment: TVs, TV games, satellite radio units, car navigation systems
- Industrial equipment: Measuring equipment, test equipment, and multiplex transmission devices

Ordering Information

Standard Models with PCB Terminals

Relay Function	Enclosure rating	Contact form	Terminal arrangement	Characteristic impedance	Model	Rated coil voltage	Minimum packing unit
Singleside stable	Fully sealed	SPDT (1c)	E-shape	75 Ω	G6Z-1PE	3, 4.5, 5, 9, 12, 24 VDC	25 pcs/tube
				50 Ω	G6Z-1PE-A		
			Y-shape	75 Ω	G6Z-1P	3, 4.5, 5, 9, 12, 24 VDC	
				50 Ω	G6Z-1P-A		
Singlewinding latching			E-shape	75 Ω	G6ZU-1PE	3, 4.5, 5, 9, 12, 24 VDC	
				50 Ω	G6ZU-1PE-A		
			Y-shape	75 Ω	G6ZU-1P	3, 4.5, 5, 9, 12, 24 VDC	
				50 Ω	G6ZU-1P-A		
Doublewinding latching	E-shape	75 Ω	G6ZK-1PE	3, 4.5, 5, 9, 12, 24 VDC			
		50 Ω	G6ZK-1PE-A				
	Y-shape	75 Ω	G6ZK-1P	3, 4.5, 5, 9, 12, 24 VDC			
		50 Ω	G6ZK-1P-A				

Note. Please add the coil rated voltage (V) to the model number when ordering.

Example: G6Z-1PE DC3

In addition, the delivered product and its package will be marked with voltage specification as "□□VDC".

●Standard Models with Surface-mounting Terminals

Relay Function	Enclosure rating	Contact form	Terminal arrangement	Characteristic impedance	Model	Rated coil voltage	Minimum packing unit	Minimum ordering unit (Tape packing)
Singleside stable	Fully sealed	SPDT (1c)	E-shape	75 Ω	G6Z-1FE	3, 4.5, 5, 9, 12 and 24 VDC	25 pcs/tube (300 pcs/reel)	300 pcs/reel
				50 Ω	G6Z-1FE-A			
			Y-shape	75 Ω	G6Z-1F			
				50 Ω	G6Z-1F-A			
Singlewinding latching			E-shape	75 Ω	G6ZU-1FE	3, 4.5, 5, 9, 12 and 24 VDC		
				50 Ω	G6ZU-1FE-A			
			Y-shape	75 Ω	G6ZU-1F			
				50 Ω	G6ZU-1F-A			
Doublewinding latching			E-shape	75 Ω	G6ZK-1FE	3, 4.5, 5, 9, 12 and 24 VDC		
				50 Ω	G6ZK-1FE-A			
			Y-shape	75 Ω	G6ZK-1F			
				50 Ω	G6ZK-1F-A			

Note 1. Please add the coil rated voltage (V) to the model number when ordering.

Example: G6Z-1PE DC3

In addition, the delivered product and its package will be marked with voltage specification as "□□VDC".

Note 2. When ordering Relays in tape packing (surface mounting terminal models), add "-TR" to the end of the model number.

This specification, however, is not part of the relay model number, so it is not marked on the relay case. (If "-TR" is not added to the end of the model number, the Relays will be provided in tube packing.)

Note 3. Consult your OMRON representative for reverse contact models.

■Ratings

●Coil: Single-side Stable Models (G6E-2P(E), G6Z-1F(E))

Rated voltage	Rated current (mA)	Coil resistance (Ω)	Must operate voltage (V)	Must release voltage (V)	Maximum voltage (V)	Power consumption (mW)
			% of rated voltage			
3 VDC	66.7	45	75% max.	10% min.	150%	Approx. 200
4.5 VDC	44.4	101				
5 VDC	40.0	125				
9 VDC	22.2	405				
12 VDC	16.7	720				
24 VDC	8.3	2,880				

●Coil: Single-winding Latching Models (G6ZU-1P(E), G6ZU-1F(E))

Rated voltage	Rated current (mA)	Coil resistance (Ω)	Must set voltage (V)	Must reset voltage (V)	Maximum voltage (V)	Power consumption (mW)
			% of rated voltage			
3 VDC	66.7	45	75% max.	75% max.	150%	Approx. 200
4.5 VDC	44.4	101				
5 VDC	40.0	125				
9 VDC	22.2	405				
12 VDC	16.7	720				
24 VDC	8.3	2,880				

●Coil: Double-winding Latching Models (G6ZK-1P(E), G6ZK-1F(E))

Rated voltage	Rated current (mA)	Coil resistance (Ω)	Must set voltage (V)	Must reset voltage (V)	Maximum voltage (V)	Power consumption (mW)
			% of rated voltage			
3 VDC	120	25	75% max.	75% max.	150%	Approx. 360
4.5 VDC	80	56				
5 VDC	72	69				
9 VDC	40	225				
12 VDC	30	400				
24 VDC	15	1,600				

Note 1. The rated current and coil resistance are measured at a coil temperature of 23°C with a tolerance of ±10%.

Note 2. The operating characteristics are measured at a coil temperature of 23°C.

Note 3. The maximum voltage is the highest voltage that can be imposed on the Relay coil instantaneously.

Note 4. The voltage measurements for operate/release and set/reset are the values obtained for instantaneous changes in the voltage (rectangular wave).

● Contacts

Item	Load	Resistive load
Rated load		10 mA at 30 VAC 10 mA at 30 VDC 10 W at 900 MHz *
Rated carry current	0.5 A	
Max. switching voltage	30 VAC, 30 VDC	
Max. switching current	0.5 A	

* This value is for an impedance of 50Ω or 75Ω with a V.SWR of 1.2 max.

● High-frequency Characteristics *1

Item	Frequency	900MHz				2.6GHz			
		TH		SMD		TH		SMD	
		E-shape	Y-shape	E-shape	Y-shape	E-shape	Y-shape	E-shape	Y-shape
Isolation	75 Ω	65 dB min.		60dB min.		35 dB min.	45 dB min.	30 dB min.	40 dB min.
	50 Ω	60 dB min.							
Insertion loss (not including substrate loss)	75 Ω	0.2 dB max.				0.5 dB max.			
	50 Ω	0.1 dB max.				0.3 dB max.			
V.SWR	75 Ω	1.2 dB max.				1.5 dB max.			
	50 Ω	1.1 dB max.				1.3 dB max.			
Return loss	75 Ω	20.8 dB min.				14.0 dB min.			
	50 Ω	26.4 dB min.				17.7 dB min.			
Maximum carry power		10W *2							

Note. The above values are initial values.

*1. Contact your OMRON representative if the Relay will be used in applications that require high repeatability with high-frequency characteristics in microload regions.

*2. These values are for an impedance of 50 Ω or 75 Ω with a V.SWR of 1.2 max.

■ Characteristics

Relay Function		Single-side stable models	Single-winding latching models	Double-winding latching models
Model		G6Z-1P(E), G6Z-1F(E)	G6ZU-1P(E), G6ZU-1F(E)	G6ZK-1P(E), G6ZK-1F(E)
Contact resistance *1		100 mΩ max.		
Operating (set) time		10 ms max.		
Release (reset) time		10 ms max.		
Minimum set/reset pulse time		—	12 ms	
Insulation resistance *2		100 MΩ min. (at 500 VDC)		
Dielectric strength	Between Coil and contacts	1,000 VAC, 50/60 Hz for 1 min		
	Between ground and coil/contacts	500 VAC, 50/60 Hz for 1 min		
	Between Contacts of the same polarity	500 VAC, 50/60 Hz for 1 min		
Vibration resistance	Destruction	10 to 55 to 10 Hz, 0.75 mm single amplitude (1.5 mm double amplitude)		
	Malfunction	10 to 55 to 10 Hz, 0.75 mm single amplitude (1.5 mm double amplitude)		
Shock resistance	Destruction	1,000 m/s ²		
	Malfunction	500 m/s ²		
Durability	Mechanical	1,000,000 operations min. (at 36,000 operations/hour)		
	Electrical	300,000 operations min. (30 VAC, 10 mA/30 VDC, 10 mA), 100,000 operations min. (900 MHz, 10 W) at a switching frequency of 1,800 operations/hour		
Ambient operating temperature		-40°C to 70°C (with no icing or condensation)		
Ambient operating humidity		5% to 85% RH		
Weight		Approx. 2.8 g		

Note. The above values are initial values.

*1. The contact resistance was measured with 10 mA at 1 VDC with a voltage drop method.

*2. The insulation resistance was measured with a 500 VDC megohmmeter applied to the same parts as those used for checking the dielectric strength.

Engineering Data

Ambient Temperature vs. Maximum Voltage

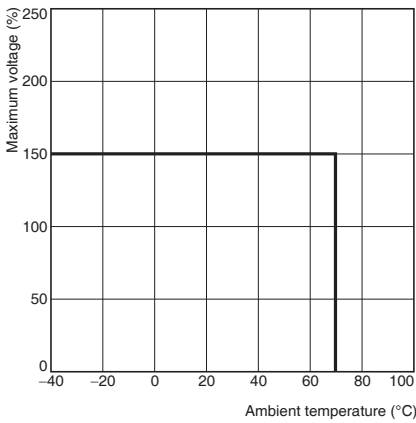

Ambient Temperature vs. Must Operate or Must Release Voltage

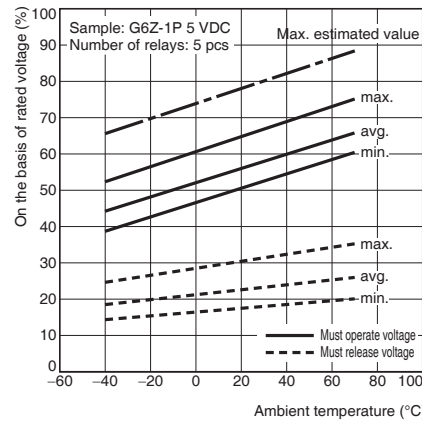

Shock Malfunction

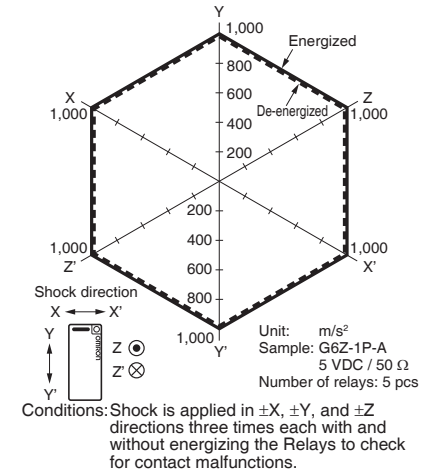

Electrical Durability (with Must Operate and Must Release Voltage) *1, *2

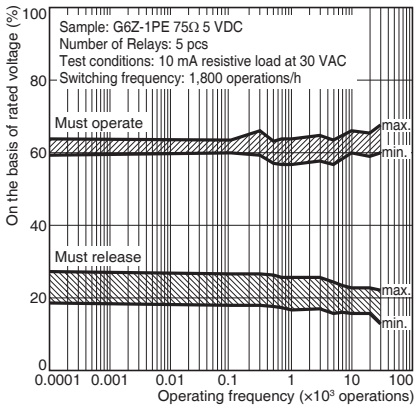

Electrical Durability (with Must Operate and Must Release Voltage)

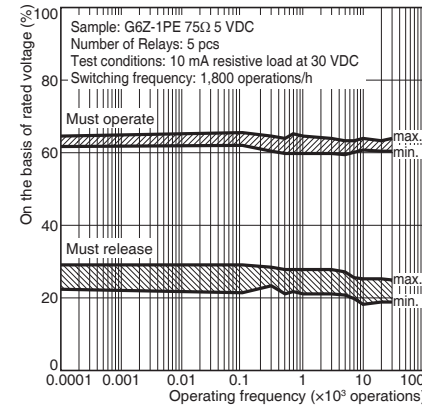

Electrical Durability (Contact Resistance) *1, *2

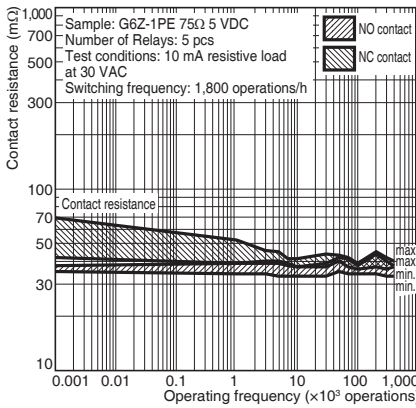

Electrical Durability (Contact Resistance) *1, *2

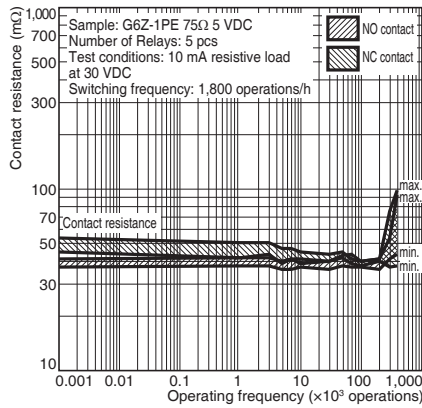

- *1. The tests were conducted at an ambient temperature of 23°C.
- *2. The contact resistance data are periodically measured reference values and are not values from each monitoring operation. Contact resistance values will vary according to the switching frequency and operating environment, so be sure to check operation under the actual operating conditions before use.

External Magnetic Interference

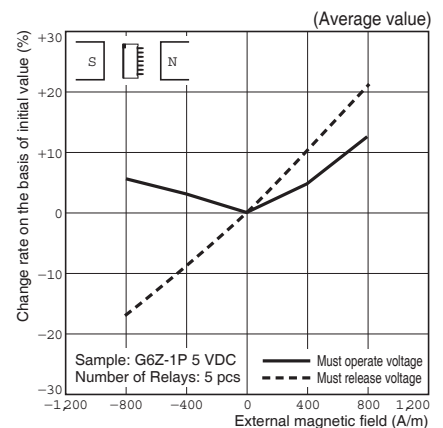
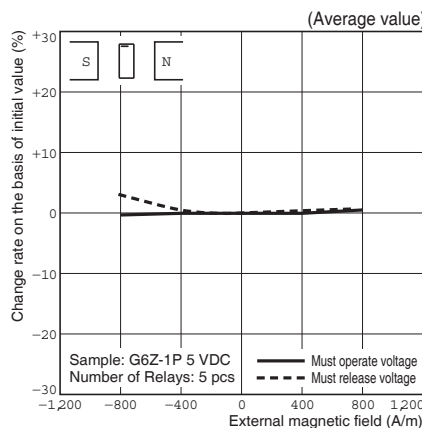
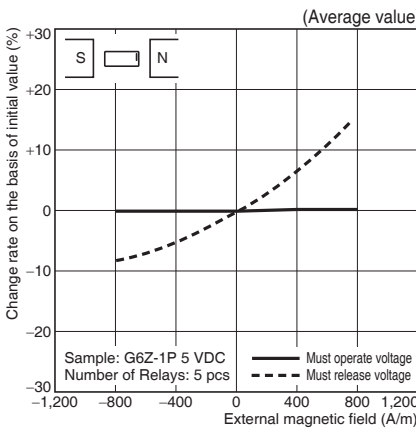

● High-frequency Characteristics at 75Ω (Isolation) *1, *2

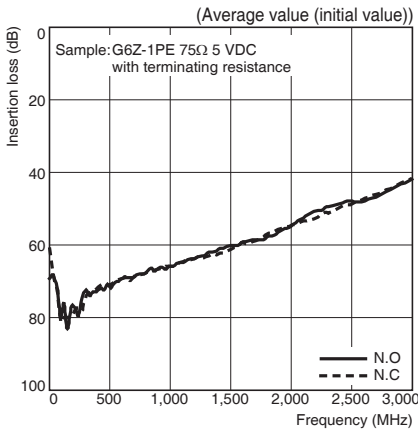

● High-frequency Characteristics at 75Ω (Insertion Loss) *1, *2

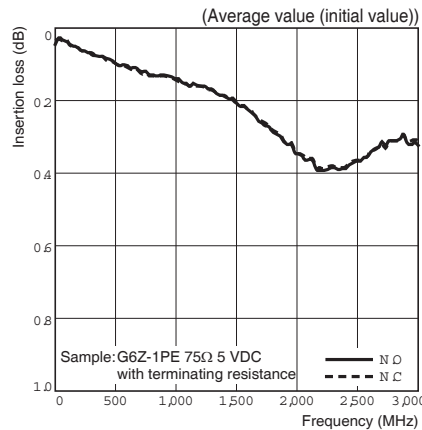

● High-frequency Characteristics at 75Ω (Return Loss, V.SWR) *1, *2

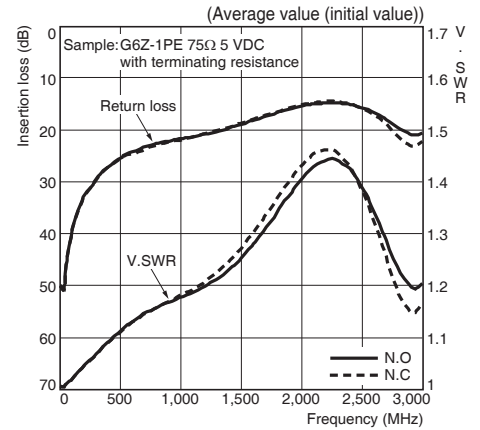

● High-frequency Characteristics at 50Ω (Isolation) *1, *2

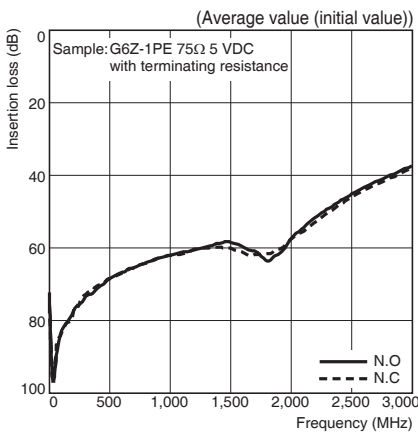

● High-frequency Characteristics at 50Ω (Insertion Loss) *1, *2

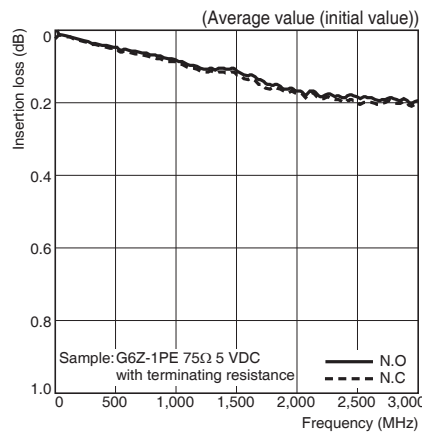

● High-frequency Characteristics at 50Ω (Return Loss, V.SWR) *1, *2

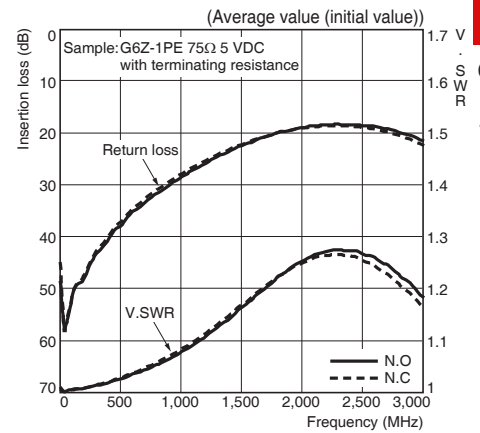

● Must Operate and Must Release Time Distribution *1

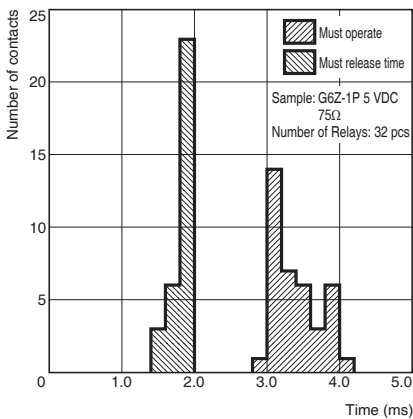

● Must Operate and Must Release Bounce Time Distribution *1

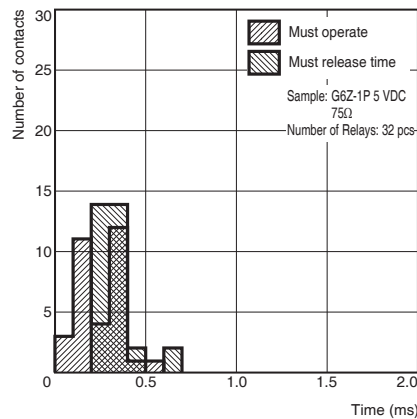

*1. The tests were conducted at an ambient temperature of 23°C.
 *2. High-frequency characteristics depend on the PCB to which the Relay is mounted. Always check these characteristics, including endurance, in the actual machine before use.

■Dimensions

(Unit: mm)

●Models with PCB Terminals

G6Z-1PE
G6ZU-1PE
G6Z-1PE-R

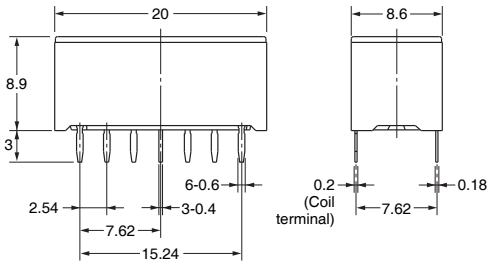
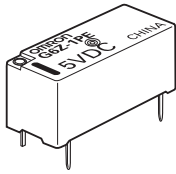

PCB Mounting Holes (Bottom View)
Tolerance: ± 0.1 mm

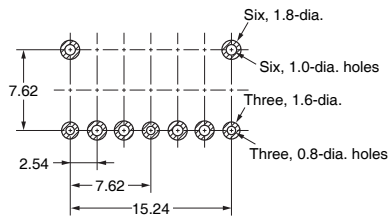

Terminal Arrangement/Internal Connections (Bottom View)

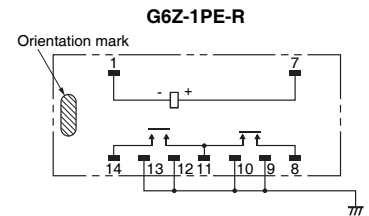
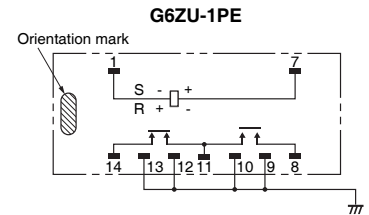
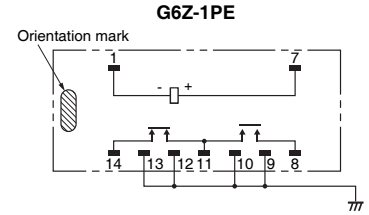

Note. Each value has a tolerance of ± 0.3 mm.

G6Z-1PE-A
G6ZU-1PE-A

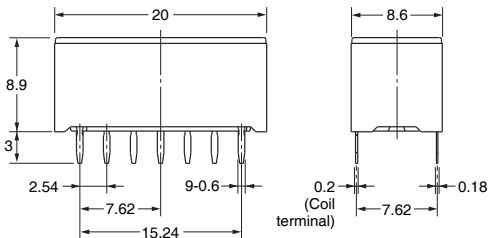
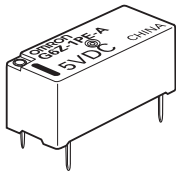

PCB Mounting Holes (Bottom View)
Tolerance: ± 0.1 mm

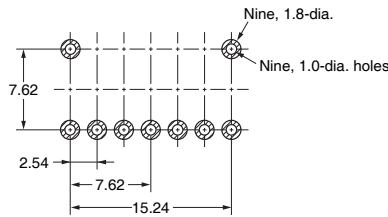

Terminal Arrangement/Internal Connections (Bottom View)

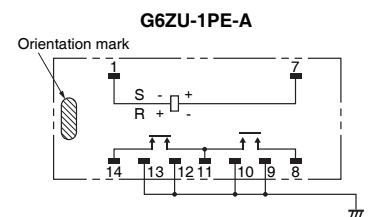
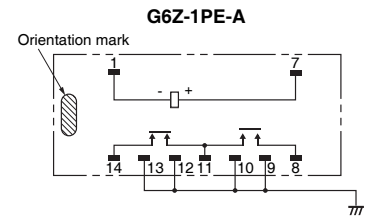

Note. Each value has a tolerance of ± 0.3 mm.

G6Z-1P
G6ZU-1P

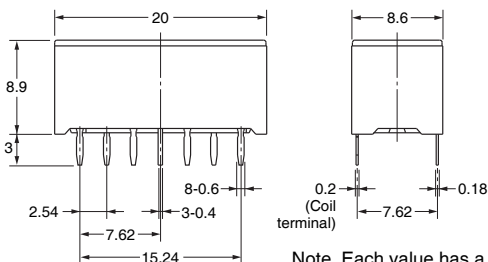
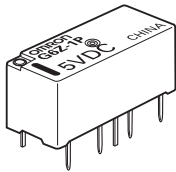

PCB Mounting Holes (Bottom View)
Tolerance: ± 0.1 mm

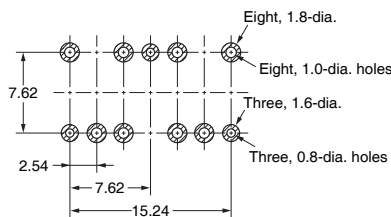

Terminal Arrangement/Internal Connections (Bottom View)

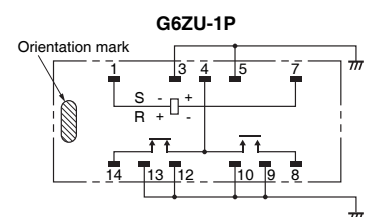
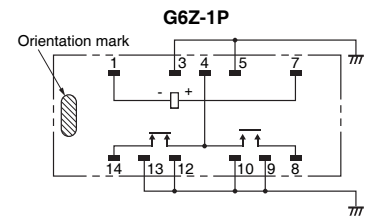

Note. Each value has a tolerance of ± 0.3 mm.

G6Z-1P-A G6ZU-1P-A

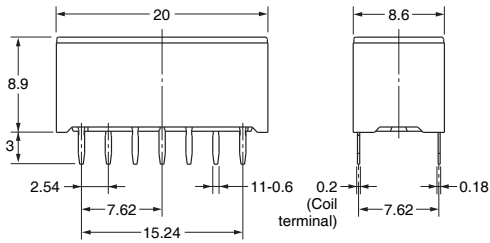
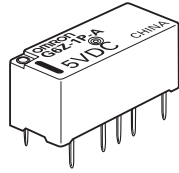

Note. Each value has a tolerance of ± 0.3 mm.

PCB Mounting Holes (Bottom View) Tolerance: ± 0.1 mm

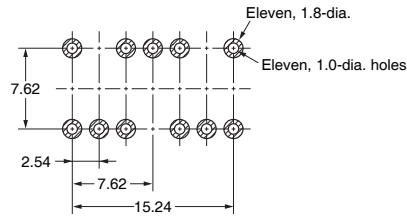

Terminal Arrangement/Internal Connections (Bottom View)

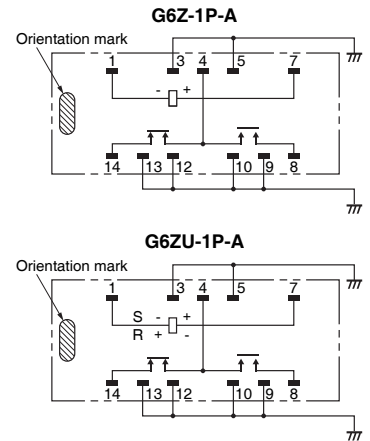

G6ZK-1PE

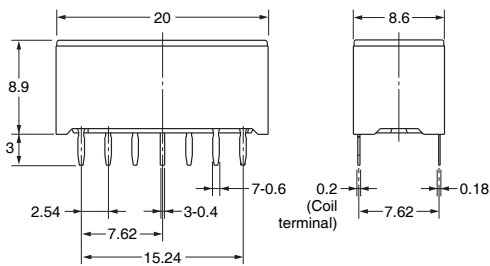
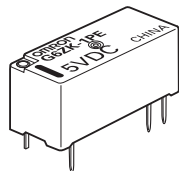

Note. Each value has a tolerance of ± 0.3 mm.

PCB Mounting Holes (Bottom View) Tolerance: ± 0.1 mm

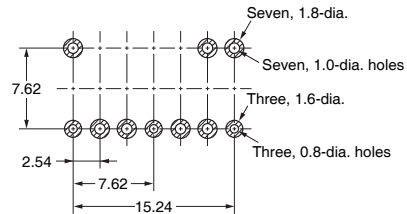

Terminal Arrangement/Internal Connections (Bottom View)

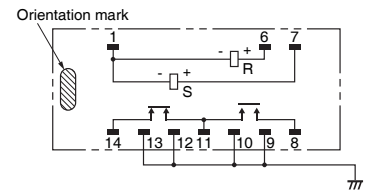

G
6
Z

G6ZK-1PE-A

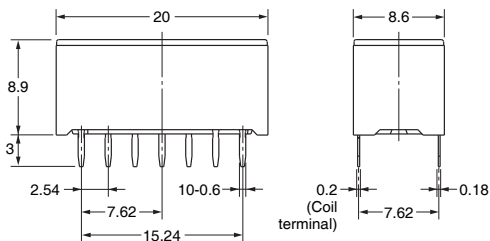
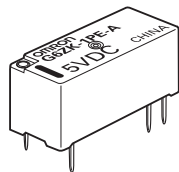

Note. Each value has a tolerance of ± 0.3 mm.

PCB Mounting Holes (Bottom View) Tolerance: ± 0.1 mm

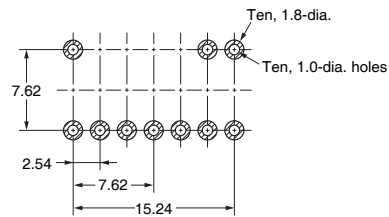

Terminal Arrangement/Internal Connections (Bottom View)

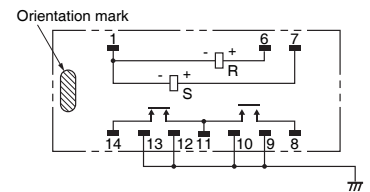

G6ZK-1P

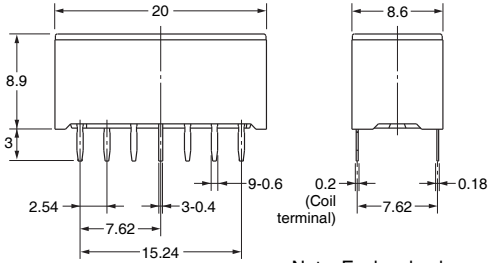
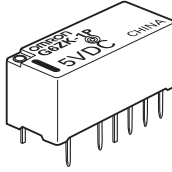

Note. Each value has a tolerance of ± 0.3 mm.

PCB Mounting Holes (Bottom View) Tolerance: ± 0.1 mm

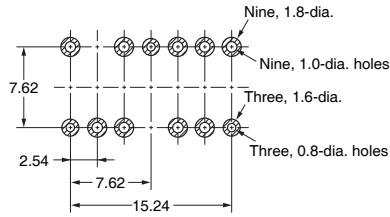

Terminal Arrangement/Internal Connections (Bottom View)

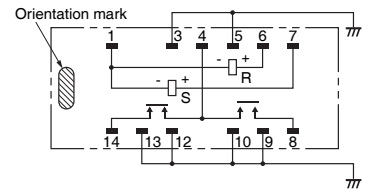

G6ZK-1P-A

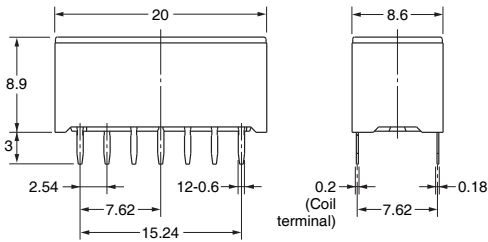
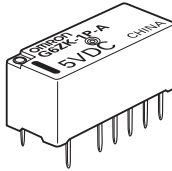

Note. Each value has a tolerance of ± 0.3 mm.

PCB Mounting Holes (Bottom View) Tolerance: ± 0.1 mm

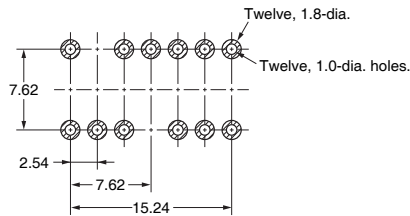

Terminal Arrangement/Internal Connections (Bottom View)

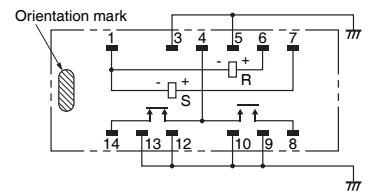

Models with Surface-mounting Terminals

G6Z-1FE G6ZU-1FE

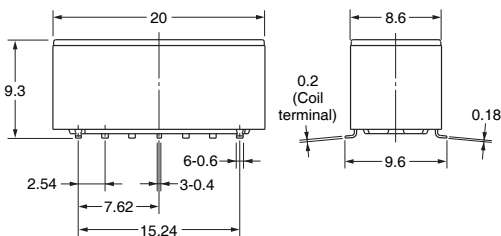
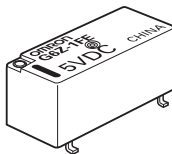

Note 1. Each value has a tolerance of ± 0.3 mm.
Note 2. The coplanarity of the terminals is 0.1 mm max.

Mounting Dimensions (Top View) Tolerance: ± 0.1 mm

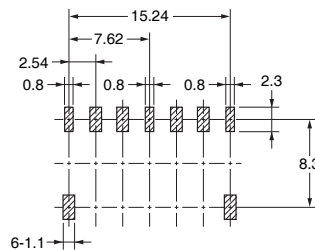

Terminal Arrangement/Internal Connections (Top View)

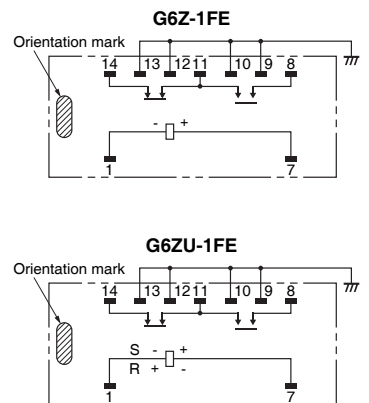

G6Z-1FE-A G6ZU-1FE-A

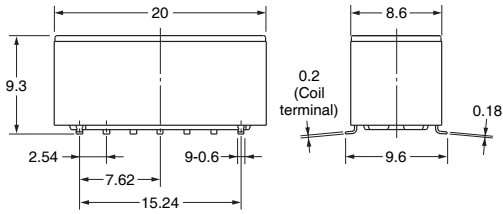
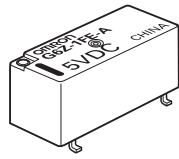

Mounting Dimensions (Top View)
Tolerance: ± 0.1 mm

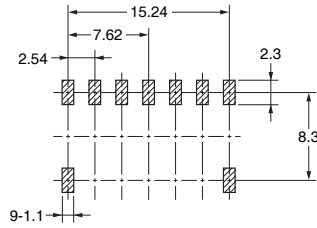

Terminal Arrangement/Internal Connections
(Top View)

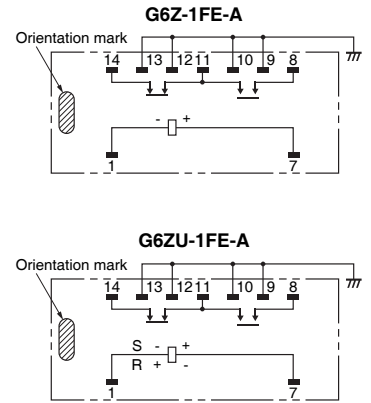

Note 1. Each value has a tolerance of ± 0.3 mm.
Note 2. The coplanarity of the terminals is 0.1 mm max.

G6Z-1F G6ZU-1F

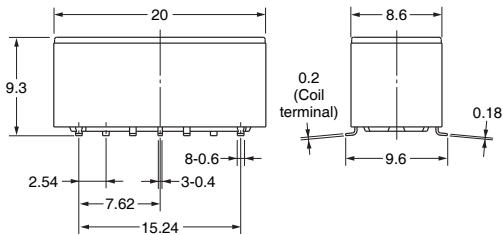
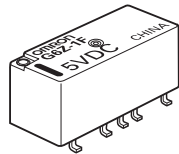

Mounting Dimensions (Top View)
Tolerance: ± 0.1 mm

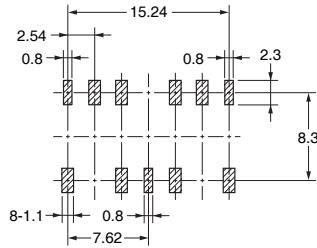

Terminal Arrangement/Internal Connections
(Top View)

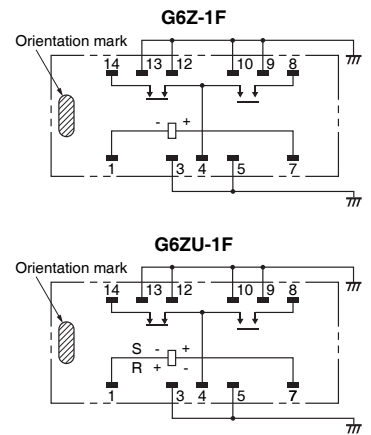

Note 1. Each value has a tolerance of ± 0.3 mm.
Note 2. The coplanarity of the terminals is 0.1 mm max.

G6Z-1F-A G6ZU-1F-A

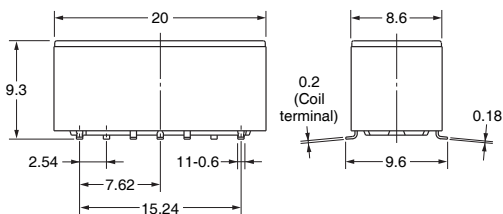
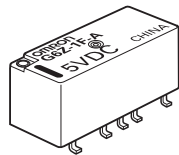

Mounting Dimensions (Top View)
Tolerance: ± 0.1 mm

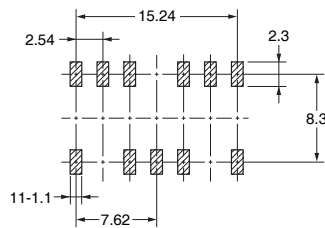

Terminal Arrangement/Internal Connections
(Top View)

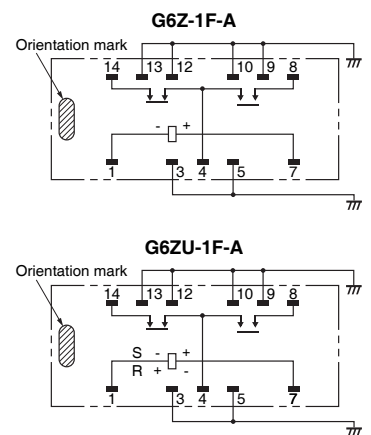

Note 1. Each value has a tolerance of ± 0.3 mm.
Note 2. The coplanarity of the terminals is 0.1 mm max.

G6ZK-1FE

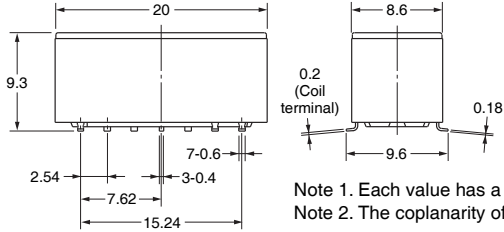
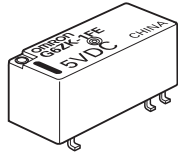

Note 1. Each value has a tolerance of ± 0.3 mm.
 Note 2. The coplanarity of the terminals is 0.1 mm max.

Mounting Dimensions (Top View)
 Tolerance: ± 0.1 mm

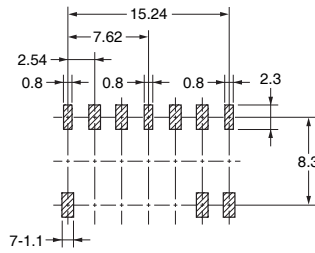

Terminal Arrangement/Internal Connections
 (Top View)

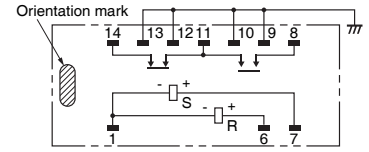

G6ZK-1FE-A

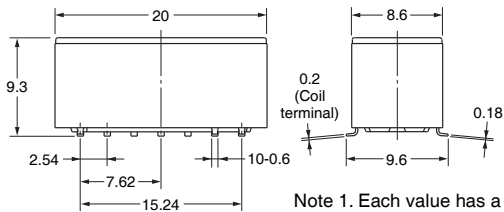
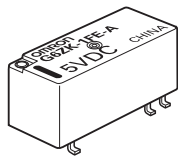

Note 1. Each value has a tolerance of ± 0.3 mm.
 Note 2. The coplanarity of the terminals is 0.1 mm max.

Mounting Dimensions (Top View)
 Tolerance: ± 0.1 mm

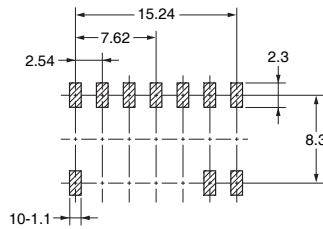

Terminal Arrangement/Internal Connections
 (Top View)

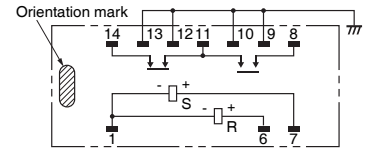

G6ZK-1F

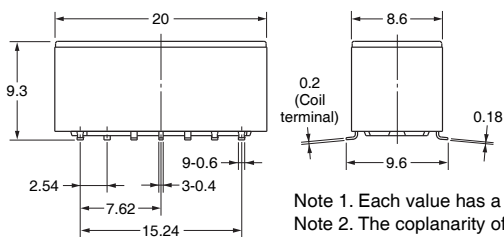
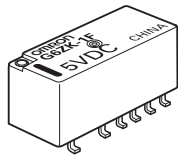

Note 1. Each value has a tolerance of ± 0.3 mm.
 Note 2. The coplanarity of the terminals is 0.1 mm max.

Mounting Dimensions (Top View)
 Tolerance: ± 0.1 mm

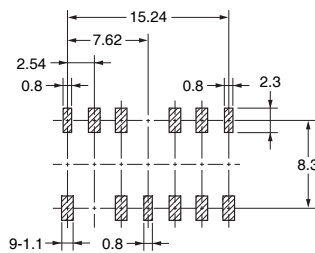

Terminal Arrangement/Internal Connections
 (Top View)

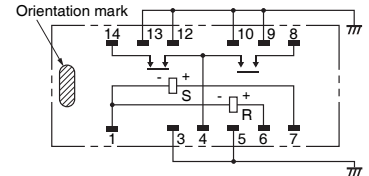

G6ZK-1F-A

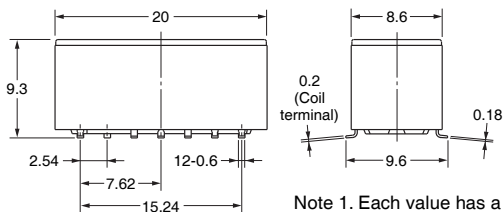
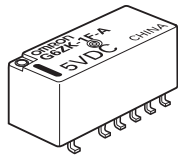

Note 1. Each value has a tolerance of ± 0.3 mm.
 Note 2. The coplanarity of the terminals is 0.1 mm max.

Mounting Dimensions (Top View)
 Tolerance: ± 0.1 mm

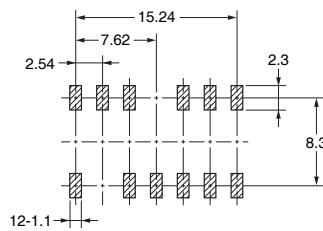

Terminal Arrangement/Internal Connections
 (Top View)

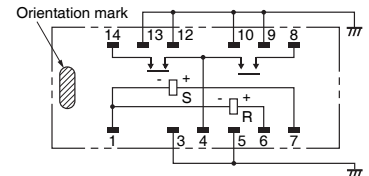

■ Tube Packing and Tape Packing

(1) Tube Packing

- Relays in tube packing are arranged so that the orientation mark of each Relay is on the left side.
- Be sure not to make mistakes in Relay orientation when mounting the Relay to the PCB.

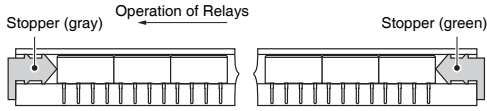

Tube length: 530 mm (stopper not included)
No. of Relays per tube: 25 pcs

(2) Tape Packing (Surface-mounting Terminal Models)

- When ordering Relays in tape packing, add the prefix “-TR” to the model number, otherwise the Relays in tube packing will be provided.
- Relays per Reel: 300 pcs
- Minimum packing unit: 1 Reel (300 pcs)

1. Direction of Relay Insertion

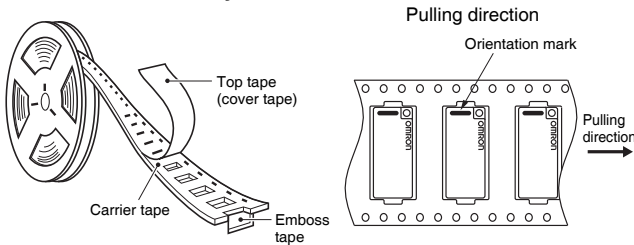

2. Reel Dimensions

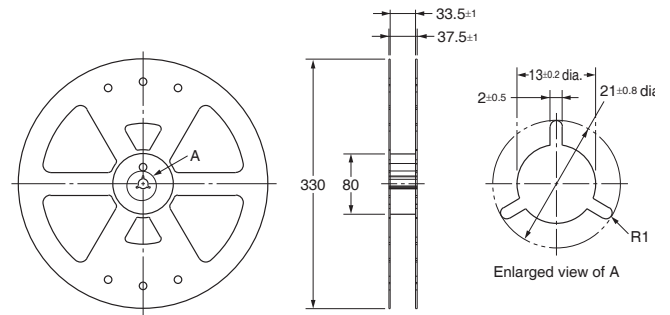

3. Carrier Tape Dimensions

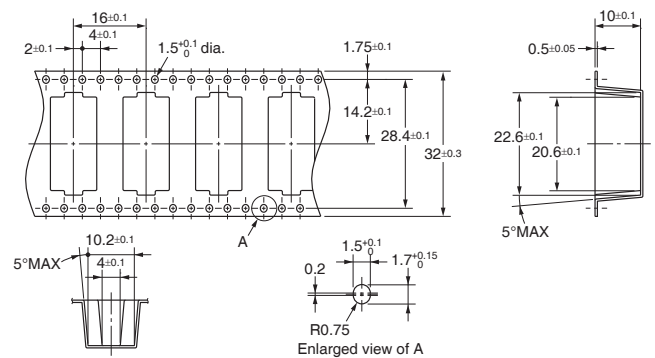

Note. The radius of the unmarked corner is 0.3 mm.

■ Recommended Soldering Method

● Temperature Conditions for IRS Method

- When using reflow soldering, ensure that the Relay terminals and the top of the case stay below the following curve. Check that these conditions are actually satisfied before soldering the terminals.

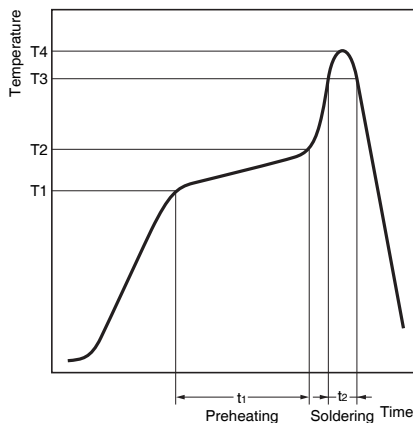

Measured part	Preheating (T1→T2, t1)	Soldering (T3, t2)	Maximum peak (T4)
Terminals	150→180°C, 120 s max.	230°C min, 30 s max.	250°C max.
Top of case	—	—	255°C max.

- Do not quench the terminals after mounting. Clean the Relay using alcohol or water no hotter than 40°C max.

- The thickness of cream solder to be applied should be between 150 and 200 μm on OMRON's recommended PCB pattern.

Correct Soldering

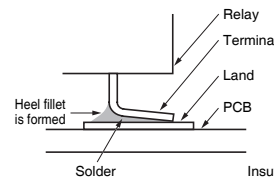

Incorrect Soldering

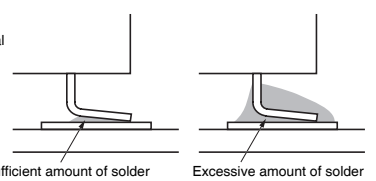

Check the soldering in the actual mounting conditions before use.

■Precautions

- For general precautions on PCB Relays, refer to the precautions provided in General Information of the Relay Product Data Book.

Correct Use

● High-frequency Characteristics Measurement Method and Measurement Substrate

- High-frequency characteristics for the G6Z are measured in the way shown below. Consult your OMRON representative for details on 50-Ω models.

Measurement Method for 75-Ω Models

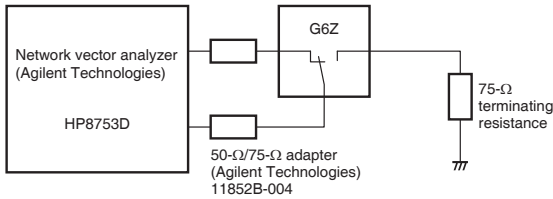

Through-hole Substrate (75-Ω Models, E-shape or Y-shape)

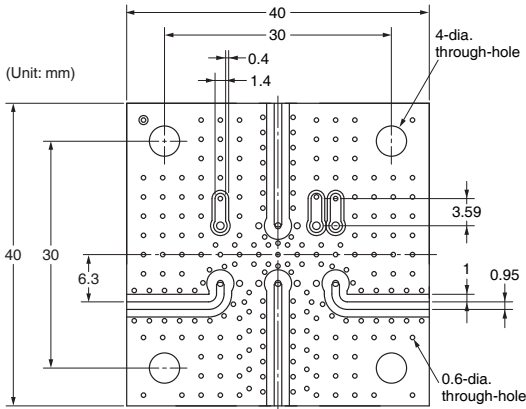

SMD-type Substrate (75-Ω Models, E-shape or Y-shape)

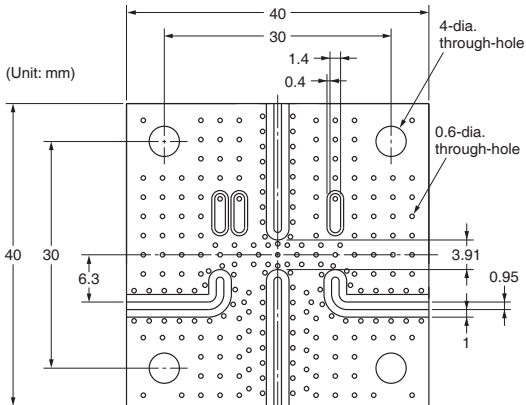

Substrate for High-frequency Characteristic Compensation (75-Ω Models, E-shape or Y-shape)

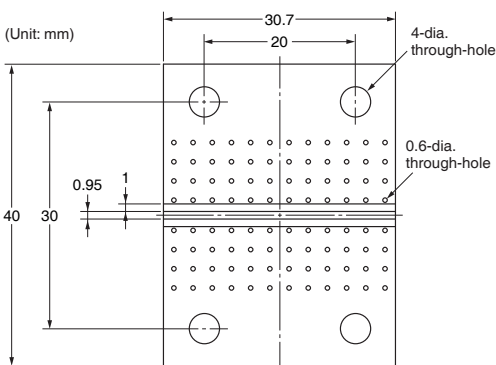

Substrate Types

Material: FR-4 glass epoxy (glass cloth impregnated with epoxy resin and copper laminated to its outer surface)

Thickness: 1.6 mm

Thickness of copper plating: 18 μm

Note 1. The compensation substrate is used when measuring the Relay's insertion loss. The insertion loss is obtained by subtracting the measured value for the compensation substrate from the measured value with the Relay mounted to the high-frequency measurement substrate.

Note 2. For convenience, the diagrams of the high-frequency measurement substrates given here apply both to models with an E-shape terminal structure and to models with a Y-shape terminal structure.

Note 3. Be sure to mount a standoff tightly to the through-hole substrate.

Note 4. Use measuring devices, connectors, and substrates that are appropriate for 50Ω and 75Ω respectively.

Note 5. Ensure that there is no pattern under the Relay. Otherwise, the impedance may be adversely affected and the Relay may not be able to attain its full characteristics.

●Handling

- Do not use the Relay if it has been dropped. Dropping the Relay may adversely affect its functionality.
- Protect the Relay from direct sunlight and keep the Relay under normal temperature, humidity, and pressure.
- Use the Relay as soon as possible after opening the moistureproof package. If the Relay is left for a long time after opening the moisture-proof package, the appearance may suffer and seal failure may occur after the solder mounting process. To store the Relay after opening the moisture-proof package, place it into the original package and sealed the package with adhesive tape.
- When washing the product after soldering the Relay to a PCB, use a water-based solvent or alcohol-based solvent, and keep the solvent temperature to less than 40°C. Do not put the relay in a cold cleaning bath immediately after soldering.

●Claw Securing Force During Automatic Mounting

- During automatic insertion of Relays, be sure to set the securing force of each claw to the following so that the Relay's characteristics will be maintained.

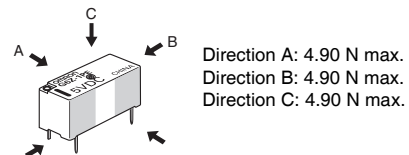

Secure the claws to the shaded area. Do not attach them to the center area or to only part of the Relay.

●Latching Relay Mounting

- Make sure that the vibration or shock that is generated from other devices, such as Relays, on the same panel or substrate and imposed on the Latching Relay does not exceed the rated value, otherwise the set/reset status of the Latching Relay may be changed. The Latching Relay is reset before shipping. If excessive vibration or shock is imposed, however, the Latching Relay may be set accidentally. Be sure to apply a reset signal before use.

●Coating

- Do not use silicone coating to coat the Relay when it is mounted to the PCB. Do not wash the PCB after the Relay is mounted using detergent containing silicone. Otherwise, the detergent may remain on the surface of the Relay.

●Repeatability

- Contact your OMRON representative if the Relay will be used in an application that requires high repeatability in high-frequency characteristics for the microload region. (Such applications include testing and measurement equipment and ATE applications.)

- Application examples provided in this document are for reference only. In actual applications, confirm equipment functions and safety before using the product.
- Consult your OMRON representative before using the product under conditions which are not described in the manual or applying the product to nuclear control systems, railroad systems, aviation systems, vehicles, combustion systems, medical equipment, amusement machines, safety equipment, and other systems or equipment that may have a serious influence on lives and property if used improperly. Make sure that the ratings and performance characteristics of the product provide a margin of safety for the system or equipment, and be sure to provide the system or equipment with double safety mechanisms.

Note: Do not use this document to operate the Unit.

Данный компонент на территории Российской Федерации

Вы можете приобрести в компании MosChip.

Для оперативного оформления запроса Вам необходимо перейти по данной ссылке:

<http://moschip.ru/get-element>

Вы можете разместить у нас заказ для любого Вашего проекта, будь то серийное производство или разработка единичного прибора.

В нашем ассортименте представлены ведущие мировые производители активных и пассивных электронных компонентов.

Нашей специализацией является поставка электронной компонентной базы двойного назначения, продукции таких производителей как XILINX, Intel (ex.ALTERA), Vicor, Microchip, Texas Instruments, Analog Devices, Mini-Circuits, Amphenol, Glenair.

Сотрудничество с глобальными дистрибьюторами электронных компонентов, предоставляет возможность заказывать и получать с международных складов практически любой перечень компонентов в оптимальные для Вас сроки.

На всех этапах разработки и производства наши партнеры могут получить квалифицированную поддержку опытных инженеров.

Система менеджмента качества компании отвечает требованиям в соответствии с ГОСТ Р ИСО 9001, ГОСТ РВ 0015-002 и ЭС РД 009

Офис по работе с юридическими лицами:

105318, г.Москва, ул.Щербаковская д.3, офис 1107, 1118, ДЦ «Щербаковский»

Телефон: +7 495 668-12-70 (многоканальный)

Факс: +7 495 668-12-70 (доб.304)

E-mail: info@moschip.ru

Skype отдела продаж:

moschip.ru

moschip.ru_4

moschip.ru_6

moschip.ru_9