

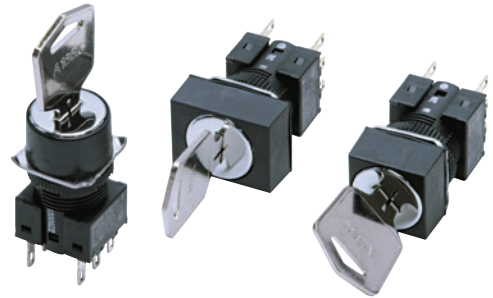

# A165K

## Separate Construction with Cylindrical 16-dia. Body

- Short mounting depth, less than 28.5 mm below panel
- Wide range of switching capacity from standard to microload
- Oil-resistant IP65 models



 Refer to *Safety Precautions for All Pushbutton Switches and Safety Precautions* on page 11.

## List of Models

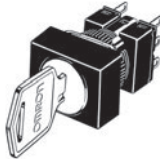
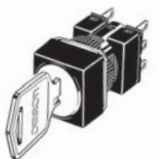
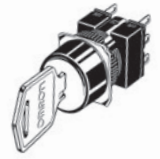
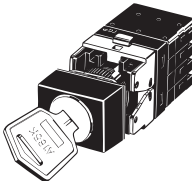
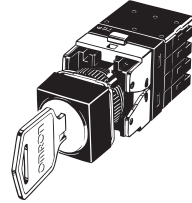
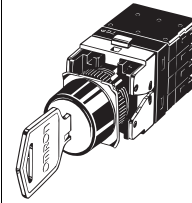
|                           | Model   |   |   |
|---------------------------|---|---|---|
|                           | Rectangular   | Square  | Round   |
| Solder terminals          |  <p>A165K-J Series</p>  |  <p>A165K-A Series</p>  |  <p>A165K-T Series</p>  |
| Screwless clamp connector |  <p>A165K-J Series</p> |  <p>A165K-A Series</p> |  <p>A165K-T Series</p> |

## Model Number Structure

**Model Number Legend** ..... The model numbers used to order sets of Units are illustrated below. One set comprises the Selector, Switch, and 2 Keys.  
For information on combinations, refer to *Ordering Information* on page 3.

A 1 6 5 K - <sup>(1)</sup> J <sup>(2)</sup> 3 M L - <sup>(3)</sup> 2

### (1) Shape of Selector

| Symbol | Shape       | Color |
|--------|-------------|-------|
| J      | Rectangular | Black |
| A      | Square      |       |
| T      | Round       |       |

### (2) Number of Notches/Resetting Method

| Symbol | No. of notches | Reset method            | Key release position |
|--------|----------------|-------------------------|----------------------|
| 2ML    | 2 notches      | Manual                  | Left                 |
| 2MR    |                |                         | Right                |
| 2M     |                |                         | Left and right       |
| 2AL    |                | Automatic               | Left                 |
| 3MC    | 3 notches      | Manual                  | Center               |
| 3MR    |                |                         | Right                |
| 3ML    |                |                         | Left                 |
| 3M     |                | Left, right, and center |                      |
| 3AC    | 3 notches      | Automatic               | Center               |

### (3) Contact Configuration

| Symbol | Type | Terminal         |
|--------|------|------------------|
| 1      | SPDT | Solder Terminal  |
| 2      | DPDT |                  |
| 2S     | DPDT | Screw-less Clamp |

Note: Only DPDT contacts are available with 3-notch models.

## Ordering Information

**Ordering as a Set** ..... The model numbers used to order sets of Units are given in the following tables. One set comprises the Selector, Switch and 2 Keys.

### Solder Terminals

Rectangular Models



Oil-resistant IP65

| Number of notches | Output | Reset method   | Key release position    | Model        |
|-------------------|--------|----------------|-------------------------|--------------|
| 2 notches         | SPDT   | Manual         | Left                    | A165K-J2ML-1 |
|                   |        |                | Right                   | A165K-J2MR-1 |
|                   |        |                | Left and right          | A165K-J2M-1  |
|                   | DPDT   | Automatic      | Left                    | A165K-J2AL-1 |
|                   |        |                | Left                    | A165K-J2ML-2 |
|                   |        |                | Right                   | A165K-J2MR-2 |
| DPDT              | Manual | Left and right | A165K-J2M-2             |              |
|                   |        | Left           | A165K-J2AL-2            |              |
|                   |        | Left           | A165K-J3MC-2            |              |
| 3 notches         | DPDT   | Manual         | Right                   | A165K-J3MR-2 |
|                   |        |                | Left                    | A165K-J3ML-2 |
|                   |        |                | Left, right, and center | A165K-J3M-2  |

Square Models



Oil-resistant IP65

| Number of notches | Output | Reset method   | Key release position    | Model        |
|-------------------|--------|----------------|-------------------------|--------------|
| 2 notches         | SPDT   | Manual         | Left                    | A165K-A2ML-1 |
|                   |        |                | Right                   | A165K-A2MR-1 |
|                   |        |                | Left and right          | A165K-A2M-1  |
|                   | DPDT   | Automatic      | Left                    | A165K-A2AL-1 |
|                   |        |                | Left                    | A165K-A2ML-2 |
|                   |        |                | Right                   | A165K-A2MR-2 |
| DPDT              | Manual | Left and right | A165K-A2M-2             |              |
|                   |        | Left           | A165K-A2AL-2            |              |
|                   |        | Left           | A165K-A3MC-2            |              |
| 3 notches         | DPDT   | Manual         | Right                   | A165K-A3MR-2 |
|                   |        |                | Left                    | A165K-A3ML-2 |
|                   |        |                | Left, right, and center | A165K-A3M-2  |

Round Models





Oil-resistant IP65

| Number of notches | Output | Reset method   | Key release position    | Model        |
|-------------------|--------|----------------|-------------------------|--------------|
| 2 notches         | SPDT   | Manual         | Left                    | A165K-T2ML-1 |
|                   |        |                | Right                   | A165K-T2MR-1 |
|                   |        |                | Left and right          | A165K-T2M-1  |
|                   | DPDT   | Automatic      | Left                    | A165K-T2AL-1 |
|                   |        |                | Left                    | A165K-T2ML-2 |
|                   |        |                | Right                   | A165K-T2MR-2 |
| DPDT              | Manual | Left and right | A165K-T2M-2             |              |
|                   |        | Left           | A165K-T2AL-2            |              |
|                   |        | Left           | A165K-T3MC-2            |              |
| 3 notches         | DPDT   | Manual         | Right                   | A165K-T3MR-2 |
|                   |        |                | Left                    | A165K-T3ML-2 |
|                   |        |                | Left, right, and center | A165K-T3M-2  |

**Ordering Information**

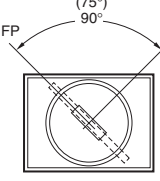
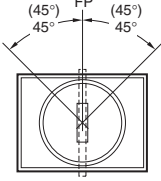

**Ordering Individually** ..... Selectors and Switches can be ordered separately. Combinations that are not available as sets can be created using individual Units. Also, store the parts as spares for maintenance and repairs.

**Operation Units (Listed on Page 5.)**

|  |   |  |   |
|--|---|--|---|
| <p>Rectangular<br/>(A165K-J)</p>  <p>Two keys are provided.</p> | <p>Square<br/>(A165K-A)</p>  | <p>Round<br/>(A165K-T)</p>  | <p>(Standard condition when shipped)</p> <div style="display: flex; justify-content: space-around;"> <div style="text-align: center;"> <p>Switches with<br/>2 Notches</p> <p>(75°)<br/>90°</p>  </div> <div style="text-align: center;"> <p>Switches with<br/>3 Notches</p> <p>(45°) FP (45°)<br/>45°</p>  </div> </div> <p>Note: The figures in parentheses are for self-resetting models.<br/>FP: Free position</p> |
|--|---|--|---|



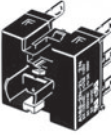
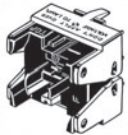

**Socket Units (Listed on Page 5.)**

|  |   |  |
|--|---|--|
| <p>Solder terminals</p>  | <p>PCB terminals</p>  | <p>Screw-less clamp connector</p>  |
|--|---|--|



## Ordering Information

**Ordering Individually** ..... Selectors and Switches can be ordered separately. Combinations that are not available as sets can be created using individual Units. Also, store the parts as spares for maintenance and repairs.

### Selectors

| Appearance  | Number of notches | Reset method | Key release position | Model      |
|---|-------------------|--------------|----------------------|------------|
| Rectangular<br>(A165K-J)<br> | 2 notches         | Manual       | ⊘                    | A165K-J2ML |
|   |                   |              | ⊘                    | A165K-J2MR |
|   |                   | Automatic    | ⊘                    | A165K-J2M  |
|   |                   |              | ⊘                    | A165K-J2AL |
|   | 3 notches         | Manual       | ⊘                    | A165K-J3MC |
|   |                   |              | ⊘                    | A165K-J3MR |
|   |                   | Automatic    | ⊘                    | A165K-J3ML |
|   |                   |              | ⊘                    | A165K-J3M  |
| Square<br>(A165K-A)<br>      | 2 notches         | Manual       | ⊘                    | A165K-A2ML |
|   |                   |              | ⊘                    | A165K-A2MR |
|   |                   | Automatic    | ⊘                    | A165K-A2M  |
|   |                   |              | ⊘                    | A165K-A2AL |
|   | 3 notches         | Manual       | ⊘                    | A165K-A3MC |
|   |                   |              | ⊘                    | A165K-A3MR |
|   |                   | Automatic    | ⊘                    | A165K-A3ML |
|   |                   |              | ⊘                    | A165K-A3M  |
| Round<br>(A165K-T)<br>      | 2 notches         | Manual       | ⊘                    | A165K-T2ML |
|   |                   |              | ⊘                    | A165K-T2MR |
|   |                   | Automatic    | ⊘                    | A165K-T2M  |
|   |                   |              | ⊘                    | A165K-T2AL |
|   | 3 notches         | Manual       | ⊘                    | A165K-T3MC |
|   |                   |              | ⊘                    | A165K-T3MR |
|   |                   | Automatic    | ⊘                    | A165K-T3ML |
|   |                   |              | ⊘                    | A165K-T3M  |
|   | Automatic         | ⊘            | A165K-T3AC           |            |

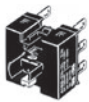
### Switches

| Appearance  | Classification |           |      | Model           |            |
|---|----------------|-----------|------|-----------------|------------|
|  | Switch         | 2 notches | SPDT | Solder terminal | A16S-2N-1  |
|   |                |           | DPDT |                 | A16S-2N-2  |
|   |                | 3 notches | DPDT |                 | A16S-3N-2  |
|  |                | 2 notches | SPDT | PCB terminal    | A16S-2N-1P |
|   |                |           | DPDT |                 | A16S-2N-2P |

### Switches with Screw-less Clamp

| Appearance  | Classification                         |      |           | Model       | Remarks     |   |
|---|--|------|-----------|-------------|-------------|---|
|  | Common to standard load and microload. | DPDT | 2 notches | Non-lighted | A16-2S      | Common to ones for pushbutton switches. |
|   |  |      | 3 notches |             | A16S-3N-2LS |   |



## Ordering Information

### Accessories and Tools (Order Separately)

#### Accessories

| Name        | Appearance  | Classification | Model      | Remarks   |
|-------------|---|----------------|------------|---|
| Panel Plugs |  | Rectangular    | A16ZJ-3003 | Used for covering the panel cutouts for future panel expansion.<br>Degree of protection: IP40<br>Color: Black |
|             |   | Square         | A16ZA-3003 |   |
|             |   | Round          | A16ZT-3003 |   |

#### Tools

| Name          | Appearance  | Model     | Applicable types  |                           |                          |                       |           | Remarks  |
|---------------|---|-----------|-------------------|---------------------------|--------------------------|-----------------------|-----------|--|
|               |   |           | Pushbutton Switch | Knob-type Selector Switch | Key-type Selector Switch | Emergency Stop Switch | Indicator |  |
| Screw Fitting |  | A16Z-3004 | Yes               | Yes                       | Yes                      | Yes                   | Yes       | Convenient for ganged installation.                                    |
| Extractor     |  | A16Z-5080 | Yes               | Yes                       | Yes                      | Yes                   | Yes       | Convenient for extracting the Lamp from a Solder-terminal Socket Unit. |

#### Key

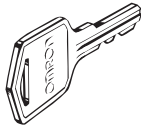
| Appearance  | Model     |
|---|-----------|
|  | A165K-KEY |

Note: Two Keys are provided.

Ordering as a Set: Refer to page 3.

- Specifications, and dimensions: Refer to page 7 to 10.
- Accessories, replacements, and tools: Refer to this page.

## Specifications

### Approved Standard Ratings

#### UL, cUL (File No. E41515)

5 A at 125 VAC, 3 A at 250 VAC (general use)  
3 A at 30 VDC (resistive)

Note: Certification has been obtained for the Switch Unit.  
For detailed information on individual products that have received certification, consult your supplier.

#### TÜV (EN60947-5-1) (Low Voltage Directive)

3 A at 250 VAC  
3 A at 30 VDC

#### CCC (GB14048.5)

5 A at 125 VAC  
3 A at 250 VAC  
3 A at 30 VDC

### Ratings

#### Contacts

| Rated voltage | Resistive load |
|---------------|----------------|
| 125 VAC       | 5 A            |
| 250 VAC       | 3 A            |
| 30 VDC        | 3 A            |

Minimum applicable load: 1 mA at 5 VDC

Rated values are obtained from tests conducted under the following conditions.

1. Load: Resistive load
2. Mounting conditions: No vibration and no shock
3. Temperature: 20±2°C
4. Operating frequency: 20 times/min

#### Contact Form

| Name | Contact form |
|------|--------------|
| SPDT |              |

### Characteristics

#### Socket Units

| Item                            | Type                                    | Key-type Selector Switch  |
|---------------------------------|---|---|
| Allowable operating frequency   | Mechanical                              | 20 operations/minute max.   |
|                                 | Electrical                              | 10 operations/minute max.   |
| Insulation resistance           |   | 100 MΩ min. (at 500 VDC)  |
| Dielectric strength             | Between terminals of same polarity      | 1,000 VAC, 50/60 Hz for 1 minute                                    |
|                                 | Between terminals of different polarity | 2,000 VAC, 50/60 Hz for 1 minute                                    |
|                                 | Between each terminal and ground        | 2,000 VAC, 50/60 Hz for 1 minute                                    |
| Vibration resistance            | Malfunction                             | 10 to 55 Hz, 1.5-mm double amplitude (malfunction within 1 ms)      |
| Shock resistance                | Destruction                             | 500 m/s <sup>2</sup>  |
|                                 | Malfunction                             | 150 m/s <sup>2</sup> max. (malfunction within 1 ms)                 |
| Durability                      | Mechanical                              | 250,000 operations min. (durability of key: 10,000 operations min.) |
|                                 | Electrical                              | 100,000 operations min.   |
| Electric shock protection class |   | Class II  |
| PTI (tracking characteristic)   |   | 175   |
| Degree of contamination         |   | 3 (IEC60947-5-1)  |
| Weight                          |   | Approx. 26.5 g (in the case of a DPDT switch key)                   |
| Ambient operating temperature   |   | -10°C to 55°C (with no icing or condensation)                       |
| Ambient operating humidity      |   | 35% to 85%RH  |
| Ambient storage temperature     |   | -25°C to 65°C (with no icing or condensation)                       |

#### Screw-less Clamp

| Item                              | Type             | Screw-less Clamp   |                     |                      |                      |
|-----------------------------------|------------------|--|---------------------|----------------------|----------------------|
| Recommended wire size             |                  | 0.5 mm <sup>2</sup> twisted wire or 0.8 mm-dia. solid wire |                     |                      |                      |
| Usable wires and tensile strength | Twisted wire     | 0.3 mm <sup>2</sup>  | 0.5 mm <sup>2</sup> | 0.75 mm <sup>2</sup> | 1.25 mm <sup>2</sup> |
|                                   | Solid wire       | 0.5 mm dia.  | 0.8 mm dia.         | 1.0 mm dia.          | ---                  |
|                                   | Tensile strength | 10 N   | 20 N                | 30 N                 | 40 N                 |
| Length of exposed wire            |                  | 10 ±1 mm   |                     |                      |                      |
| Compliant standards               |                  | JIS C 2811 Terminal Blocks for Industrial Use              |                     |                      |                      |

### Operating Characteristics

| Characteristics           | Type | Key-type Selector Switch |                                 |
|---------------------------|------|--------------------------|---------------------------------|
|                           |      | 2 notches                | 3 notches                       |
| Operating force (OF) max. |      | 0.1 N·m                  |                                 |
| Set position (SP)         |      | 90±5°                    | 45° <sup>+10</sup> <sub>0</sub> |

#### Operation Angle

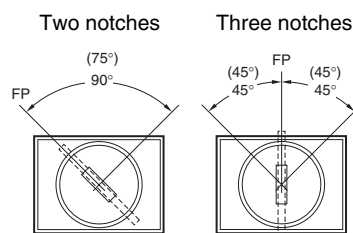

Note: The angle used for automatic reset is shown in parentheses.  
FP: Free position

#### Contact Configuration

| No. of notches | Contact configuration |    |          |     |     |
|----------------|-----------------------|----|----------|-----|-----|
|                | SPDT                  |    | DPDT     |     |     |
|                | Position              | SW | Position | SW1 | SW2 |
| 2 notches      |                       |    |          |     |     |
| 3 notches      | ---                   |    |          |     |     |
|                |                       |    |          |     |     |
|                |                       |    |          |     |     |

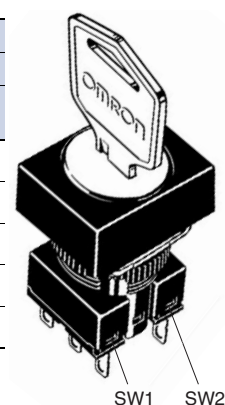

## Nomenclature

### Model Structure

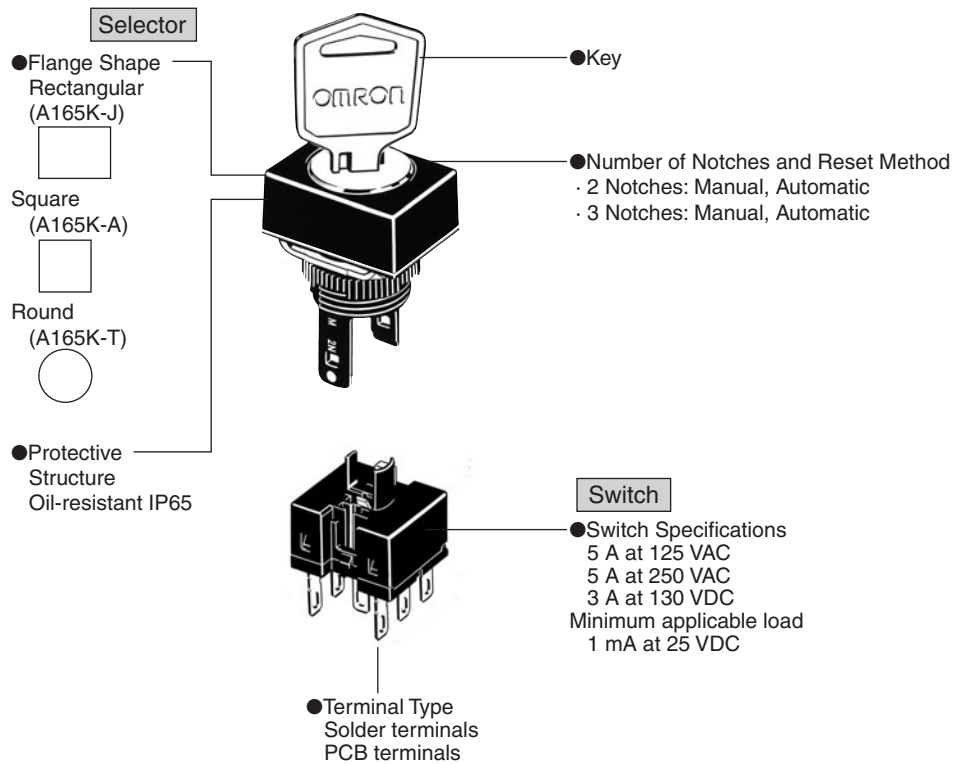

**The flange can be rotated to easily change the operation angle of the knob.**

For information on rotating the flange, refer to the A165S/W datasheet.

Example: Knob-type Selector Switch with Two Notches

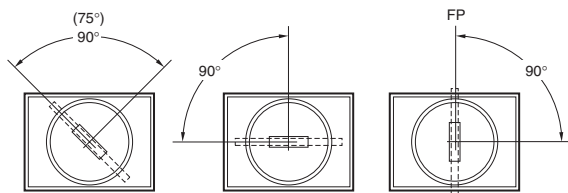

(Standard condition when shipped)

Note: The angle is 75° for self-resetting models.



## Dimensions The Dimension shows 2-switch outputs.

### Rectangular A165K-J Solder terminals (tab terminals #110)

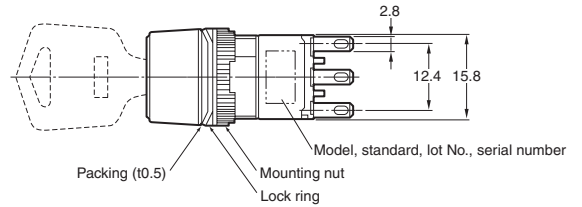
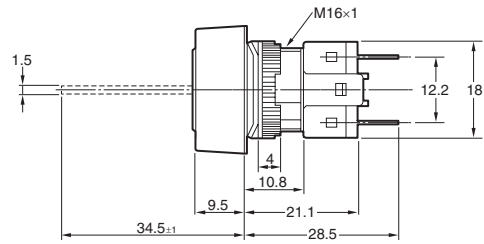
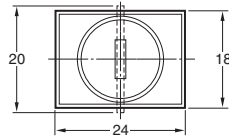
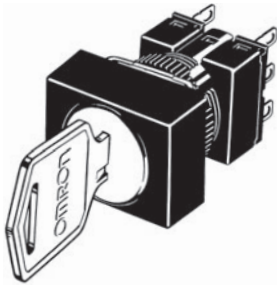

\* Refer to the A165S/W for Panel cutouts.

### Square A165K-A Solder terminals (tab terminals #110)

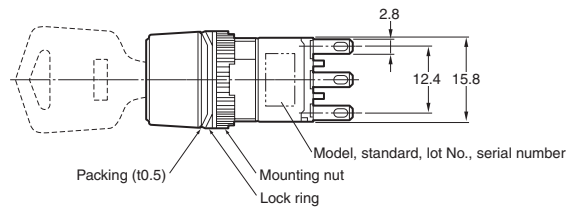
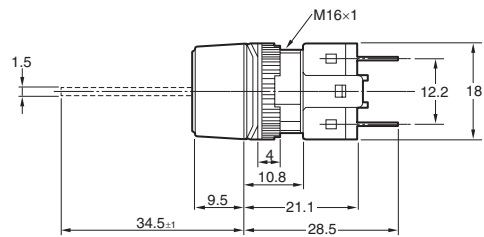
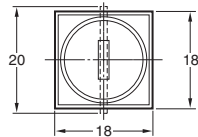
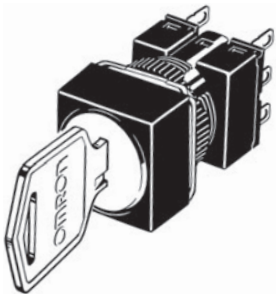

\* Refer to the A165S/W for Panel cutouts.

### Round A165K-T Solder terminals (tab terminals #110)

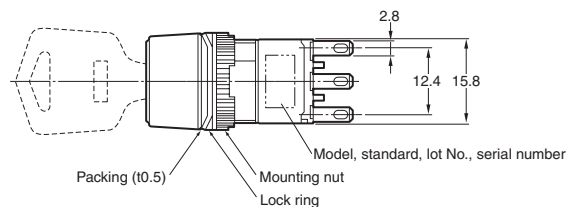
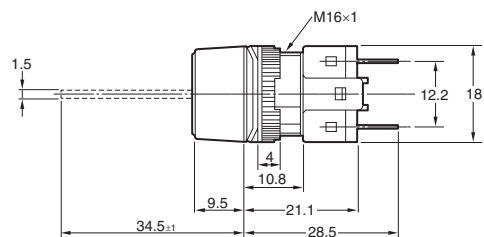
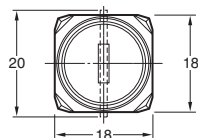
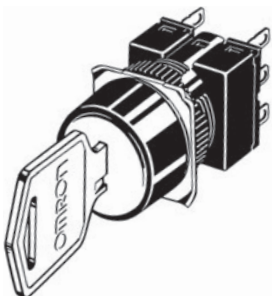

\* Refer to the A165S/W for Panel cutouts.

## Dimensions

• The Dimension shows 2-switch outputs. • The lamp terminal is also provided with non-lighted models. • A rectangular model is listed as an example. (Unit: mm)

### Rectangular A165K□-2S

#### Screw-Less Clamp

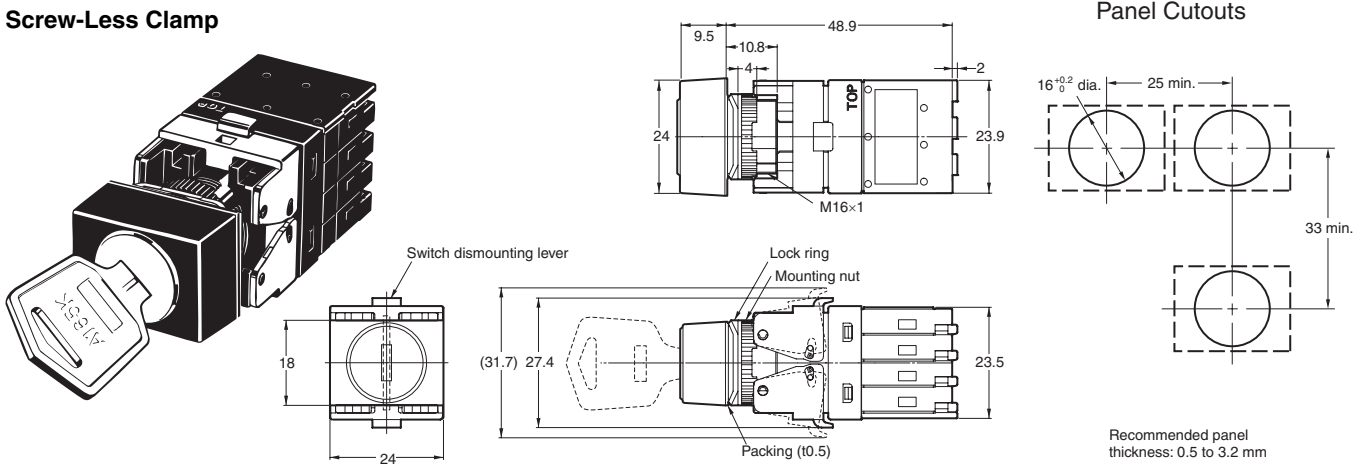

### Terminal Arrangement

For information on the terminal arrangement, refer to the A165S/W datasheet.

### Panel Mounting and Socket Unit Mounting and Removal

Refer to the A16 Pushbutton Switch datasheet.

### Flange Rotation

Refer to the A165S/W datasheet.

## Safety Precautions

Refer to *Safety Precautions for All Pushbutton Switches*.

### WARNING

Do not apply a voltage between the incandescent lamp and the terminal that is greater than the rated voltage. If the incandescent lamp is broken, the operating part may pop out.



Always turn OFF the power and wait for 10 minutes before replacing the incandescent lamp. If the lamp is replaced immediately after the power is turned OFF, the remaining heat may cause burns.



### Precautions for Correct Use

#### Mounting

- Always make sure that the power is turned OFF before mounting, removing, or wiring the Switch, or performing maintenance.
- Do not tighten the mounting nut more than necessary using tools such as pointed-nose pliers. Doing so will damage the mounting nut.  
The tightening torque is 0.29 to 0.49 N·m.

#### Wiring

- Solder terminals and quick-connect terminals (#110) are commonly used for terminals.
- Be sure to use electrical wires that are a size appropriate for the applied voltage and carry current (conductor size is 0.5 to 0.75 mm<sup>2</sup>). Perform soldering according to the conditions provided below. If the soldering is not properly performed, the lead wires will become detached, resulting in short-circuits.
  1. Hand soldering: 350°C, within 3 s
  2. Dip soldering: 350°C, within 3 s  
Wait for one minute after soldering before exerting any external force on the solder.
- Use non-corrosive resin fluid as the flux.
- Make sure that the electric cord is wired so that it does not touch the Unit. If the electric cord touches the Unit, then electric wires with a heat resistance of 100°C min. must be used.
- After wiring the Switch, maintain an appropriate clearance and creepage distance.

#### Operating Environment

- The IP65 model is designed with a degree of protection so that it will not sustain damage if it is subjected to water from any direction to the front of the panel.

#### Using the Microload

- Insert a contact protection circuit, if necessary, to prevent the reduction of life expectancy due to extreme wear on the contacts caused by loads where inrush current occurs when the contact is opened and closed.
- The A16 allows both a standard load (125 V at 5A, 250 V at 3 A) and a microload. If a standard load is applied, however, the microload area cannot be used. If the microload area is used with a standard load, the contact surface will become rough, and the opening and closing of the contact for a microload may become unreliable.
- The minimum applicable load is the N-level reference value. This value indicates the malfunction reference level for the reliability level of 60% ( $\lambda 60$ ) (conforming to JIS C5003).  
The equation,  $\lambda 60 = 0.5 \times 10^{-4}/\text{operations}$  indicates that the estimated malfunction rate is less than 1/2,000,000 operations with a reliability level of 60%.

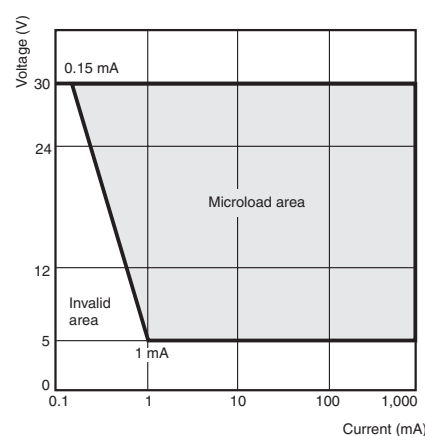

## Others

- The oil-resistant IP65 uses NBR rubber and is resistant to general cutting oil and cooling oil. Some particular oils cannot be used with the oil-resistant IP65, however, so contact your OMRON representative for details.
- If the panel is to be finished with coating, etc., make sure that the panel meets the specified dimensions after the coating.
- Do not subject the Switch to extreme shock or vibration. Doing so will cause malfunctions and damage to the Switch. Do not let sharp objects come into contact with the Switches that are made of resin. Doing so will damage the Switches, causing scratches on the outside of the operating parts, and malfunction. When handling the Switches, do not throw or drop them.

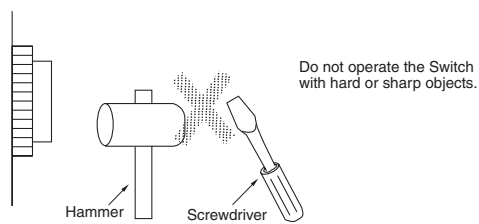
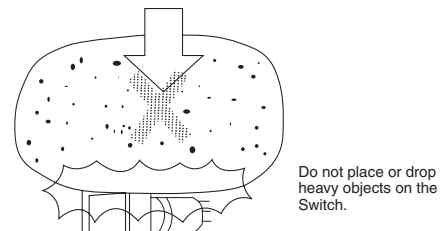
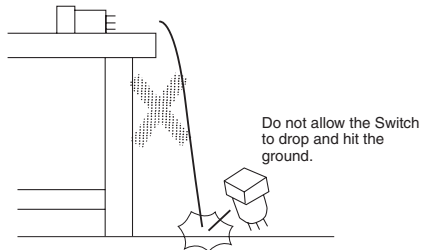

## Read and Understand This Catalog

Please read and understand this catalog before purchasing the products. Please consult your OMRON representative if you have any questions or comments.

## Warranty and Limitations of Liability

### WARRANTY

OMRON's exclusive warranty is that the products are free from defects in materials and workmanship for a period of one year (or other period if specified) from date of sale by OMRON.

OMRON MAKES NO WARRANTY OR REPRESENTATION, EXPRESS OR IMPLIED, REGARDING NON-INFRINGEMENT, MERCHANTABILITY, OR FITNESS FOR PARTICULAR PURPOSE OF THE PRODUCTS. ANY BUYER OR USER ACKNOWLEDGES THAT THE BUYER OR USER ALONE HAS DETERMINED THAT THE PRODUCTS WILL SUITABLY MEET THE REQUIREMENTS OF THEIR INTENDED USE. OMRON DISCLAIMS ALL OTHER WARRANTIES, EXPRESS OR IMPLIED.

### LIMITATIONS OF LIABILITY

OMRON SHALL NOT BE RESPONSIBLE FOR SPECIAL, INDIRECT, OR CONSEQUENTIAL DAMAGES, LOSS OF PROFITS OR COMMERCIAL LOSS IN ANY WAY CONNECTED WITH THE PRODUCTS, WHETHER SUCH CLAIM IS BASED ON CONTRACT, WARRANTY, NEGLIGENCE, OR STRICT LIABILITY.

In no event shall the responsibility of OMRON for any act exceed the individual price of the product on which liability is asserted.

IN NO EVENT SHALL OMRON BE RESPONSIBLE FOR WARRANTY, REPAIR, OR OTHER CLAIMS REGARDING THE PRODUCTS UNLESS OMRON'S ANALYSIS CONFIRMS THAT THE PRODUCTS WERE PROPERLY HANDLED, STORED, INSTALLED, AND MAINTAINED AND NOT SUBJECT TO CONTAMINATION, ABUSE, MISUSE, OR INAPPROPRIATE MODIFICATION OR REPAIR.

## Application Considerations

### SUITABILITY FOR USE

OMRON shall not be responsible for conformity with any standards, codes, or regulations that apply to the combination of products in the customer's application or use of the products.

At the customer's request, OMRON will provide applicable third party certification documents identifying ratings and limitations of use that apply to the products. This information by itself is not sufficient for a complete determination of the suitability of the products in combination with the end product, machine, system, or other application or use.

The following are some examples of applications for which particular attention must be given. This is not intended to be an exhaustive list of all possible uses of the products, nor is it intended to imply that the uses listed may be suitable for the products:

- Outdoor use, uses involving potential chemical contamination or electrical interference, or conditions or uses not described in this catalog.
- Nuclear energy control systems, combustion systems, railroad systems, aviation systems, medical equipment, amusement machines, vehicles, safety equipment, and installations subject to separate industry or government regulations.
- Systems, machines, and equipment that could present a risk to life or property.

Please know and observe all prohibitions of use applicable to the products.

NEVER USE THE PRODUCTS FOR AN APPLICATION INVOLVING SERIOUS RISK TO LIFE OR PROPERTY WITHOUT ENSURING THAT THE SYSTEM AS A WHOLE HAS BEEN DESIGNED TO ADDRESS THE RISKS, AND THAT THE OMRON PRODUCTS ARE PROPERLY RATED AND INSTALLED FOR THE INTENDED USE WITHIN THE OVERALL EQUIPMENT OR SYSTEM.

### PROGRAMMABLE PRODUCTS

OMRON shall not be responsible for the user's programming of a programmable product, or any consequence thereof.

## Disclaimers

### CHANGE IN SPECIFICATIONS

Product specifications and accessories may be changed at any time based on improvements and other reasons.

It is our practice to change model numbers when published ratings or features are changed, or when significant construction changes are made. However, some specifications of the products may be changed without any notice. When in doubt, special model numbers may be assigned to fix or establish key specifications for your application on your request. Please consult with your OMRON representative at any time to confirm actual specifications of purchased products.

### DIMENSIONS AND WEIGHTS

Dimensions and weights are nominal and are not to be used for manufacturing purposes, even when tolerances are shown.

### PERFORMANCE DATA

Performance data given in this catalog is provided as a guide for the user in determining suitability and does not constitute a warranty. It may represent the result of OMRON's test conditions, and the users must correlate it to actual application requirements. Actual performance is subject to the OMRON Warranty and Limitations of Liability.

### ERRORS AND OMISSIONS

The information in this document has been carefully checked and is believed to be accurate; however, no responsibility is assumed for clerical, typographical, or proofreading errors, or omissions.

2009.9

In the interest of product improvement, specifications are subject to change without notice.

**OMRON Corporation**  
Industrial Automation Company

<http://www.ia.omron.com/>

(c)Copyright OMRON Corporation 2009 All Right Reserved.

## Данный компонент на территории Российской Федерации

### Вы можете приобрести в компании MosChip.

Для оперативного оформления запроса Вам необходимо перейти по данной ссылке:

<http://moschip.ru/get-element>

Вы можете разместить у нас заказ для любого Вашего проекта, будь то серийное производство или разработка единичного прибора.

В нашем ассортименте представлены ведущие мировые производители активных и пассивных электронных компонентов.

Нашей специализацией является поставка электронной компонентной базы двойного назначения, продукции таких производителей как XILINX, Intel (ex.ALTERA), Vicor, Microchip, Texas Instruments, Analog Devices, Mini-Circuits, Amphenol, Glenair.

Сотрудничество с глобальными дистрибьюторами электронных компонентов, предоставляет возможность заказывать и получать с международных складов практически любой перечень компонентов в оптимальные для Вас сроки.

На всех этапах разработки и производства наши партнеры могут получить квалифицированную поддержку опытных инженеров.

Система менеджмента качества компании отвечает требованиям в соответствии с ГОСТ Р ИСО 9001, ГОСТ РВ 0015-002 и ЭС РД 009

### Офис по работе с юридическими лицами:

105318, г.Москва, ул.Щербаковская д.3, офис 1107, 1118, ДЦ «Щербаковский»

Телефон: +7 495 668-12-70 (многоканальный)

Факс: +7 495 668-12-70 (доб.304)

E-mail: [info@moschip.ru](mailto:info@moschip.ru)

Skype отдела продаж:

moschip.ru

moschip.ru\_4

moschip.ru\_6

moschip.ru\_9