

ORB SERIES

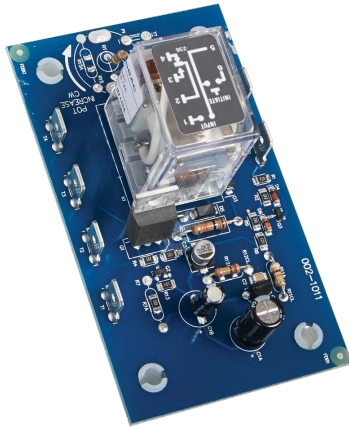

Description

The ORB Series' open PCB construction offers the user good economy without sacrificing performance and reliability. The output relay is available in isolated, 10A, DPDT or SPDT forms. The time delay may be ordered as factory fixed, onboard knob, or external adjustment. All connections are 0.25 in. (6.35 mm) male quick connect terminals.

Operation (Delay-on-Break)

Input voltage must be applied before and during timing. Upon closure of the initiate switch, the output relay energizes. The time delay begins when the initiate switch is opened (trailing edge triggered). The output remains energized during timing. At the end of the time delay, the output de-energizes. The output will energize if the initiate switch is closed when input voltage is applied.

Reset: Reclosing the initiate switch during timing resets the time delay. Loss of input voltage resets the time delay and output.

Wiring Diagram

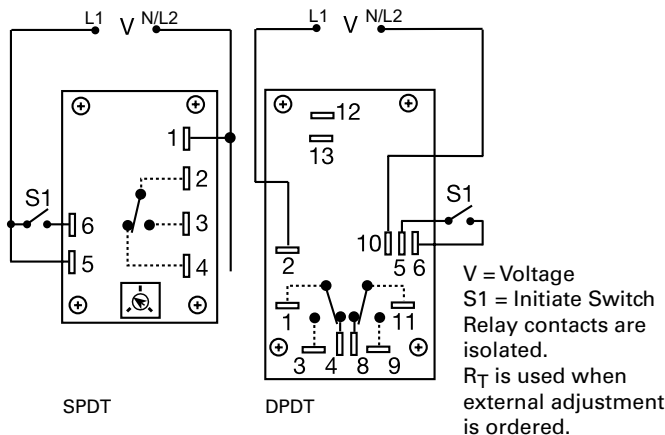

Ordering Information

MODEL	INPUT VOLTAGE	ADJUSTMENT	TIME DELAY	OUTPUT FORM
ORB120A160	120VAC	Fixed	60s	SPDT
ORB120A25	120VAC	Onboard	3 - 300s	SPDT
ORB24A11D	24VAC	Fixed	1s	DPDT
ORB24A21D	24VAC	Onboard	0.05 - 3s	DPDT
ORB24A25	24VAC	Onboard	3 - 300s	SPDT

If you don't find the part you need, call us for a custom product 800-843-8848

Features & Benefits

FEATURES	BENEFITS
Open PCB construction	Reduces cost for OEM applications
Analog circuitry	Repeat accuracy + / - 2%, Factory calibration + / - 10%
Isolated, 10A, SPDT or DPDT output contacts	Allows control of loads for AC or DC voltages
Line voltage initiation	Separate control voltage is not required for operation

Accessories

 **P1004-12, P1004-12-X Versa-Pot**
Panel mountable, industrial potentiometer recommended for remote time delay adjustment.

 **P0700-7 Versa-Knob**
Designed for 0.25 in (6.35 mm) shaft of Versa-Pot. Semi-gloss industrial black finish.

 **P1015-64 (AWG 14/16) Female Quick Connect**
These 0.25 in. (6.35 mm) female terminals are constructed with an insulator barrel to provide strain relief.

 **P1015-18 Quick Connect to Screw Adapter**
Screw adapter terminal designed for use with all modules with 0.25 in. (6.35 mm) male quick connect terminals.

ORB SERIES

Specifications

Time Delay

Type Analog circuitry
Range 0.05 - 300s in 5 adjustable ranges or fixed
Repeat Accuracy ±2% or 20ms, whichever is greater
Tolerance (Factory Calibration) Adjustable: guaranteed range
 Fixed: ±10%

Reset Time ≤ 50ms
Initiate Time ≤ 70ms
Time Delay vs Temp. & Voltage ≤ ±10%

Input

Voltage 24, 120, or 230VAC
Tolerance
24VAC -15% - 20%
120 & 230VAC -20% - 10%
AC Line Frequency 50/60 Hz
Power Consumption 2.25W

Output

Type Electromechanical relay
Form Isolated, SPDT or DPDT
Rating 10A resistive @ 120/240VAC & 28VDC;
 1/3 hp @ 120/240VAC
Life Mechanical - 1x10⁷; Electrical - 1x10⁶

Protection

Isolation Voltage ≥1500V RMS input to output

Mechanical

Mounting Surface mount with four #6 (M3.5 x 0.6) screws
Dimensions **H** 53.8 mm (2.12"); **W** 93.7 mm (3.69");
D 47.8 mm (1.88")

Termination 0.25 in. (6.35 mm) male quick connect terminals

Environmental

Operating/Storage Temperature -20° to 65°C / -30° to 85°C
Weight ≈ 2.7 oz (77 g)

Selection Guides

R _T Selection Chart					
Desired Time Delay*					R _T Megohm
Seconds					
1	2	3	4	5	
0.05	0.5	0.6	1.2	3.0	0.0
0.5	5.0	10	20	50	0.5
1.0	10	20	40	100	1.0
1.5	15	30	60	150	1.5
2.0	20	40	80	200	2.0
2.5	25	50	100	250	2.5
3.0	30	60	120	300	3.0

* When selecting an external R_T add at least 20% for tolerance of unit and the R_T.

Function Diagram

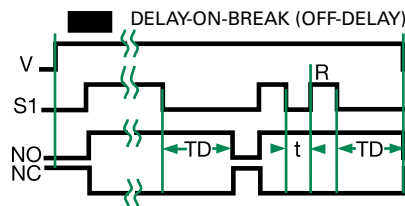

V = Voltage
 S1 = Initiate Switch
 NO = Normally Open Contact
 NC = Normally Closed Contact
 TD = Time Delay
 t = Incomplete Time Delay
 R = Reset
 = Undefined Time

Данный компонент на территории Российской Федерации

Вы можете приобрести в компании MosChip.

Для оперативного оформления запроса Вам необходимо перейти по данной ссылке:

<http://moschip.ru/get-element>

Вы можете разместить у нас заказ для любого Вашего проекта, будь то серийное производство или разработка единичного прибора.

В нашем ассортименте представлены ведущие мировые производители активных и пассивных электронных компонентов.

Нашей специализацией является поставка электронной компонентной базы двойного назначения, продукции таких производителей как XILINX, Intel (ex.ALTERA), Vicor, Microchip, Texas Instruments, Analog Devices, Mini-Circuits, Amphenol, Glenair.

Сотрудничество с глобальными дистрибьюторами электронных компонентов, предоставляет возможность заказывать и получать с международных складов практически любой перечень компонентов в оптимальные для Вас сроки.

На всех этапах разработки и производства наши партнеры могут получить квалифицированную поддержку опытных инженеров.

Система менеджмента качества компании отвечает требованиям в соответствии с ГОСТ Р ИСО 9001, ГОСТ РВ 0015-002 и ЭС РД 009

Офис по работе с юридическими лицами:

105318, г.Москва, ул.Щербаковская д.3, офис 1107, 1118, ДЦ «Щербаковский»

Телефон: +7 495 668-12-70 (многоканальный)

Факс: +7 495 668-12-70 (доб.304)

E-mail: info@moschip.ru

Skype отдела продаж:

moschip.ru

moschip.ru_4

moschip.ru_6

moschip.ru_9