

| PART NUMBER | RELAY DESCRIPTION |
|-------------|--|
| C75-2 | SSR with Short Circuit Protection & Terminals for Through Hole Mount |
| C75-2S | SSR with Short Circuit Protection, Trip Status, & Terminals for Through Hole Mount |
| C75-2SH | SSR with Short Circuit Protection, Trip Status, Over Voltage Spike Protection Terminals for Through Hole Mount |
| SC75-2 | SSR with Short Circuit Protection & Terminals for Surface Mount |
| SC75-2S | SSR with Short Circuit Protection, Trip Status, & Terminals for Surface Mount |
| SC75-2SH | SSR with Short Circuit Protection, Trip Status, Over Voltage Spike Protection. Terminals for Surface Mount |

ELECTRICAL SPECIFICATIONS

(-40°C to 85°C UNLESS OTHERWISE SPECIFIED)

INPUT (CONTROL) SPECIFICATIONS

| Parameter (see Note 1) | Min | Max | Units |
|------------------------------------|-----|-----|-------|
| Control Voltage Range | 4.5 | 5.5 | Vdc |
| Input Current @5Vdc (See Figure 1) | 12 | 18 | mAdc |
| Must Turn-On Voltage | 4.2 | | Vdc |
| Must Turn-Off Voltage | | 1.5 | Vdc |

OUTPUT (LOAD) SPECIFICATIONS

| Parameter (see Note 1) | Min | Max | Units |
|--|-----------------|------|-------|
| Load Voltage Rating | | 60 | Vdc |
| Transient Blocking Voltage | | 80 | Vdc |
| Output Current Rating @25°C (See Figure 2) | | 1.0 | Adc |
| On Resistance (See Figure 3) | | 0.9 | Ohm |
| Leakage Current at Rated Voltage | | 100 | µAdc |
| Turn-On Time | | 2.0 | ms |
| Turn-Off Time | | 2.0 | ms |
| Input to Output Capacitance @ 1KHz | | 5 | pF |
| Dielectric Strength | 1000 | | Vac |
| Insulation Resistance | 10 ⁸ | | Ohm |
| Junction Temperature | | 130 | °C |
| Electrical System Spike (see note 8) | | ±600 | VPK |

STATUS SPECIFICATIONS

| Parameter | Min | Max | Units |
|--------------------------------|-----|-----|-------|
| Status Leakage Current @ 15Vdc | | 1 | µAdc |
| Status Blocking Voltage | | 32 | Vdc |
| Status "On" Voltage @ 10 mAdc | | 0.4 | Vdc |
| Status "On" Current | 10 | | mAdc |



FEATURES/BENEFITS

- Short Circuit Protected: Prevents damage to system components, assemblies and system wiring
- Trip Status: Provides status monitoring and feedback of the protection state
- Optical Isolation: Isolates control circuits from load transients Eliminates ground loops and signal ground noise
- Low Off-State Leakage: For high off-state impedance
- Switches High Currents: To 1.0 Adc
- High Dielectric Strength: For safety and for protection of control and signal level circuits

DESCRIPTION

The C75-2S solid state relay utilizes a power FET switch that is protected against overload and short circuit currents. Protection is provided against turn-on into a short circuit, shorts that occur while conducting loads up to rated or for long term overload currents above rated that slowly overheat the relay. Once the protection trips the relay off it will remain off until reset by cycling the input control. Using the C75-2S to switch power loads can prevent fires, damage to system assemblies and system wiring. The power FET output offers low "On" resistance and can switch loads in either the high or the low side of the power line. The C75-2 is packaged in a 16 pin DIP, with surface mount or through hole mounting available. The C75-2SH also provides an open collector trip status feedback to the relay's control side for short circuit and thermal trip monitoring.

H = Relay has an internal over voltage suppressor for inductive loads.

ELECTRICAL CHARACTERISTICS

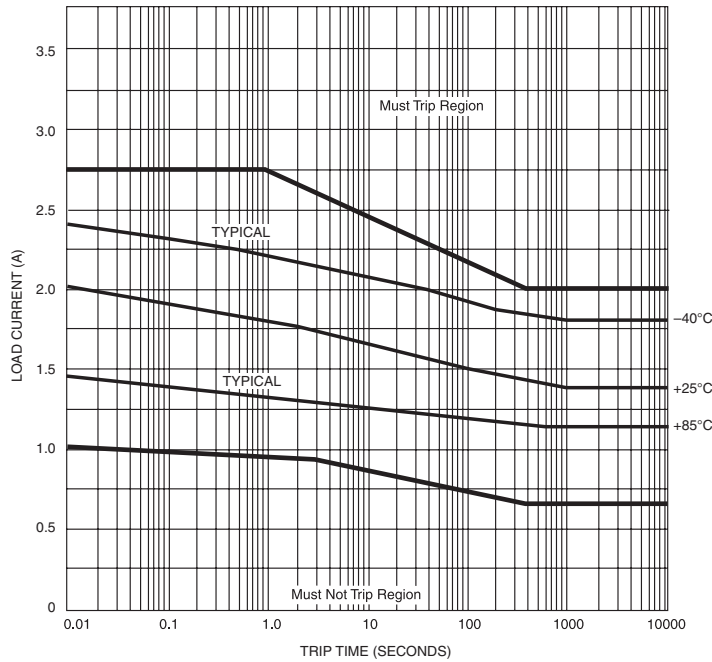

TYPICAL TRIPP CURRENT VS. TIME
FIGURE 4

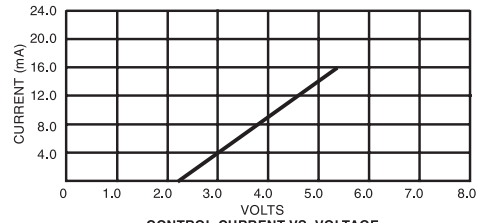

CONTROL CURRENT VS. VOLTAGE
FIGURE 1 (See Note 6)

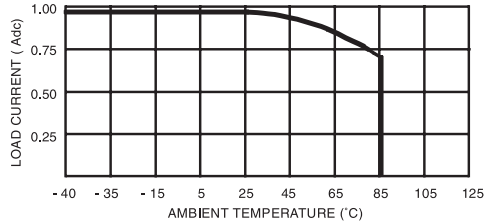

LOAD CURRENT DERATING VS. AMBIENT TEMPERATURE
FIGURE 2 (See Note 5)

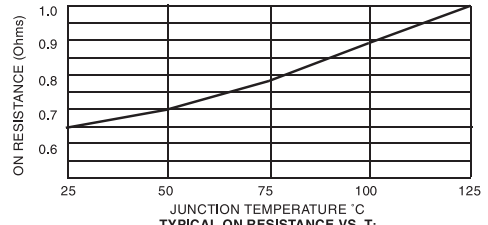

TYPICAL ON RESISTANCE VS. T_j
FIGURE 3

MECHANICAL SPECIFICATION

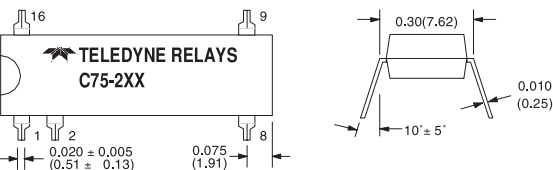
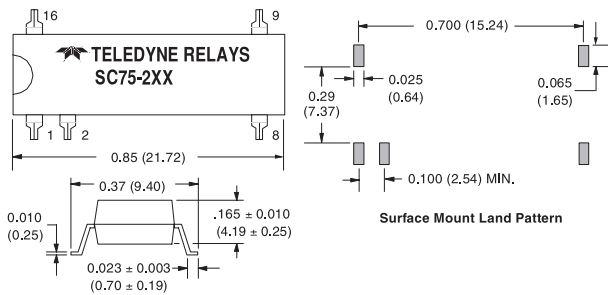

DIMENSIONS ARE IN INCHES (MILLIMETERS)
Tolerances ± 0.015 (0.38) unless specified.

WIRING CONFIGURATIONS

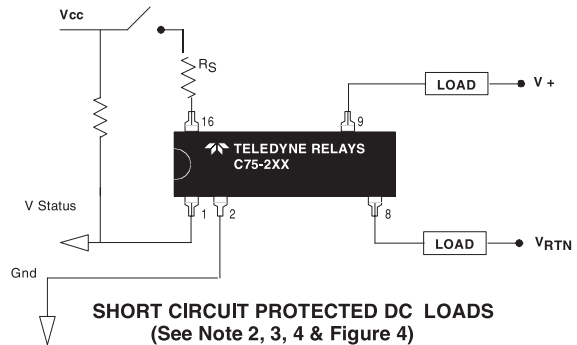

SHORT CIRCUIT PROTECTED DC LOADS
(See Note 2, 3, 4 & Figure 4)

- Operating Temperature Range -40°C to 85°C.
- Storage Temperature Range -40°C to 100°C.
- Weight: 2.0 grams maximum
- Case: 16 pin DIP package
- Case Material: Filled Epoxy, self extinguishing
- Solderability (10 sec) 260°C max

NOTES:

1. The input voltage is 5.0 Vdc for all tests unless otherwise specified.
2. For input voltage greater than 5.5 Vdc, a series resistor must be used to limit the current on the input of the relay. The resistor value shall be selected using the following equation: $R = (V_{in} - 5 \text{ volts}) / 0.015 \text{ A}$
3. Reversing the output polarity when the relay is in overload or is sustaining a short circuit may cause permanent damage.
4. Inductive loads must be diode suppressed.
5. Loads may be switched in either the high side or the low side of the power source.
5. Continuous load current is rated under the conditions of still air and mounted on a printed circuit card
6. To reset a tripped state, remove the overload condition then recycle the input signal
7. Applicable for relays with trip status only. The trip status output is an open collector transistor. Normally this transistor remains off. A trip status Low condition means an output current overload has tripped the relay off.
8. Applicable for over voltage spike protected relays only.

Данный компонент на территории Российской Федерации

Вы можете приобрести в компании MosChip.

Для оперативного оформления запроса Вам необходимо перейти по данной ссылке:

<http://moschip.ru/get-element>

Вы можете разместить у нас заказ для любого Вашего проекта, будь то серийное производство или разработка единичного прибора.

В нашем ассортименте представлены ведущие мировые производители активных и пассивных электронных компонентов.

Нашей специализацией является поставка электронной компонентной базы двойного назначения, продукции таких производителей как XILINX, Intel (ex.ALTERA), Vicor, Microchip, Texas Instruments, Analog Devices, Mini-Circuits, Amphenol, Glenair.

Сотрудничество с глобальными дистрибьюторами электронных компонентов, предоставляет возможность заказывать и получать с международных складов практически любой перечень компонентов в оптимальные для Вас сроки.

На всех этапах разработки и производства наши партнеры могут получить квалифицированную поддержку опытных инженеров.

Система менеджмента качества компании отвечает требованиям в соответствии с ГОСТ Р ИСО 9001, ГОСТ РВ 0015-002 и ЭС РД 009

Офис по работе с юридическими лицами:

105318, г.Москва, ул.Щербаковская д.3, офис 1107, 1118, ДЦ «Щербаковский»

Телефон: +7 495 668-12-70 (многоканальный)

Факс: +7 495 668-12-70 (доб.304)

E-mail: info@moschip.ru

Skype отдела продаж:

moschip.ru

moschip.ru_4

moschip.ru_6

moschip.ru_9