

Features

- High level of integration
- IGBT³ CHIP(Trench+Field Stop technology)
- Low saturation voltage and positive temperature coefficient
- Fast switching and short tail current
- Free wheeling diodes with fast and soft reverse recovery
- Solderable pins for PCB mounting
- Temperature sense included

Applications

- AC motor control
- Motion/servo control
- Inverter and power supplies

Module Characteristics ($T_J = 25^\circ\text{C}$, unless otherwise specified)

Symbol	Parameters	Test Conditions	Min	Typ	Max	Unit
$T_{J(max)}$	Max. Junction Temperature				150	$^\circ\text{C}$
$T_{J(op)}$	Operating Temperature		-40		125	$^\circ\text{C}$
T_{stg}	Storage Temperature		-40		125	$^\circ\text{C}$
V_{isol}	Insulation Test Voltage	AC, t=1min		3000		V
CTI	Comparative Tracking Index		250			
M_d	Mounting Torque	Recommended (M5)	2.5		5	N-m
Weight				300		g

Absolute Maximum Ratings ($T_J = 25^\circ\text{C}$, unless otherwise specified)

Symbol	Parameters	Test Conditions	Values	Unit
IGBT				
V_{CES}	Collector - Emitter Voltage	$T_J=25^\circ\text{C}$	1200	V
V_{GES}	Gate - Emitter Voltage		± 20	V
I_C	DC Collector Current	$T_C=25^\circ\text{C}$	200	A
		$T_C=80^\circ\text{C}$	150	A
I_{CM}	Repetitive Peak Collector Current	$t_p=1\text{ms}$	300	A
P_{tot}	Power Dissipation Per IGBT		625	W
Diode				
V_{RRM}	Repetitive Reverse Voltage	$T_J=25^\circ\text{C}$	1200	V
$I_{F(AV)}$	Average Forward Current	$T_C=25^\circ\text{C}$	200	A
		$T_C=80^\circ\text{C}$	150	A
I_{FRM}	Repetitive Peak Forward Current	$t_p=1\text{ms}$	300	A
I^2t		$T_J=125^\circ\text{C}$, t=10ms, $V_R=0\text{V}$	4350	A^2s

Electrical and Thermal Specifications ($T_J = 25^\circ\text{C}$, unless otherwise specified)

Symbol	Parameters	Test Conditions	Min	Typ	Max	Unit
IGBT						
$V_{GE(th)}$	Gate - Emitter Threshold Voltage	$V_{CE}=V_{GE}, I_C=6.0\text{mA}$	5.0	5.8	6.5	V
$V_{CE(sat)}$	Collector - Emitter	$I_C=150\text{A}, V_{GE}=15\text{V}, T_J=25^\circ\text{C}$		1.7		V
	Saturation Voltage	$I_C=150\text{A}, V_{GE}=15\text{V}, T_J=125^\circ\text{C}$		1.9		V
I_{ICES}	Collector Leakage Current	$V_{CE}=1200\text{V}, V_{GE}=0\text{V}, T_J=25^\circ\text{C}$			1	mA
		$V_{CE}=1200\text{V}, V_{GE}=0\text{V}, T_J=125^\circ\text{C}$			10	mA
I_{GES}	Gate Leakage Current	$V_{CE}=0\text{V}, V_{GE}=\pm 15\text{V}, T_J=125^\circ\text{C}$	-400		400	nA
R_{Gint}	Integrated Gate Resistor			5.0		Ω
Q_{ge}	Gate Charge	$V_{CE}=600\text{V}, I_C=150\text{A}, V_{GE}=\pm 15\text{V}$		1.4		μC
C_{ies}	Input Capacitance	$V_{CE}=25\text{V}, V_{GE}=0\text{V}, f=1\text{MHz}$		10.5		nF
C_{RES}	Reverse Transfer Capacitance			0.4		nF
$t_{d(on)}$	Turn - on Delay Time	$V_{CC}=600\text{V}$ $I_C=150\text{A}$ $R_G=2.4\Omega$ $V_{GE}=\pm 15\text{V}$ Inductive Load	$T_J=25^\circ\text{C}$		260	ns
			$T_J=125^\circ\text{C}$		290	ns
t_r	Rise Time		$T_J=25^\circ\text{C}$		30	ns
			$T_J=125^\circ\text{C}$		50	ns
$t_{d(off)}$	Turn - off Delay Time		$T_J=25^\circ\text{C}$		420	ns
			$T_J=125^\circ\text{C}$		520	ns
t_f	Fall Time		$T_J=25^\circ\text{C}$		70	ns
			$T_J=125^\circ\text{C}$		90	ns
E_{on}	Turn - on Energy		$T_J=25^\circ\text{C}$		12	mJ
			$T_J=125^\circ\text{C}$		16	mJ
E_{off}	Turn - off Energy	$T_J=25^\circ\text{C}$		11	mJ	
		$T_J=125^\circ\text{C}$		14.5	mJ	
I_{SC}	Short Circuit Current	$t_{psc} \leq 10\mu\text{s}, V_{GE}=15\text{V}, T_J=125^\circ\text{C}, V_{CC}=900\text{V}$		600		A
R_{thJC}	Junction-to-Case Thermal Resistance (Per IGBT)				0.20	K/W
Diode						
V_F	Forward Voltage	$I_F=150\text{A}, V_{GE}=0\text{V}, T_J=25^\circ\text{C}$		1.65		V
		$I_F=150\text{A}, V_{GE}=0\text{V}, T_J=125^\circ\text{C}$		1.65		V
t_{RR}	Reverse Recovery Time	$I_F=150\text{A}, V_R=600\text{V}$ $di_p/dt=3600\text{A}/\mu\text{s}$ $T_J=125^\circ\text{C}$		350		ns
I_{RRM}	Max. Reverse Recovery Current			160		A
E_{rec}	Reverse Recovery Energy			13.5		mJ
R_{thJCD}	Junction-to-Case Thermal Resistance (Per Diode)				0.36	K/W

NTC Characteristics ($T_J = 25^\circ\text{C}$, unless otherwise specified)

Symbol	Parameters	Test Conditions	Min	Typ	Max	Unit
R_{25}	Resistance	$T_c=25^\circ\text{C}$		5		K Ω
$B_{25/50}$				3375		K

Figure 1: Typical Output Characteristics for IGBT Inverter

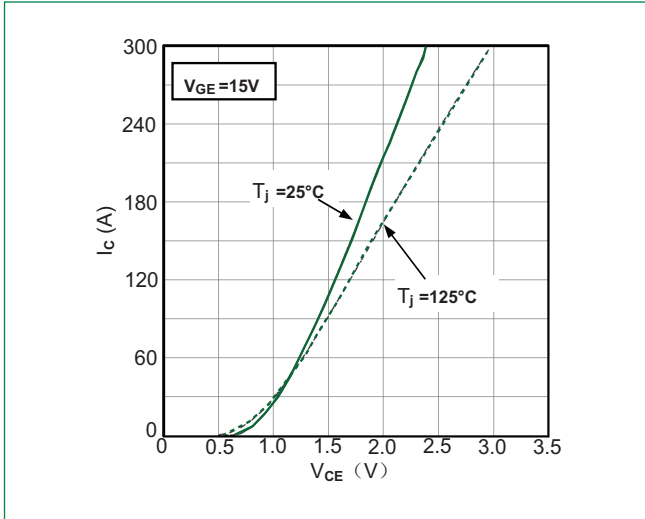

Figure 2: Typical Output Characteristics for IGBT Inverter

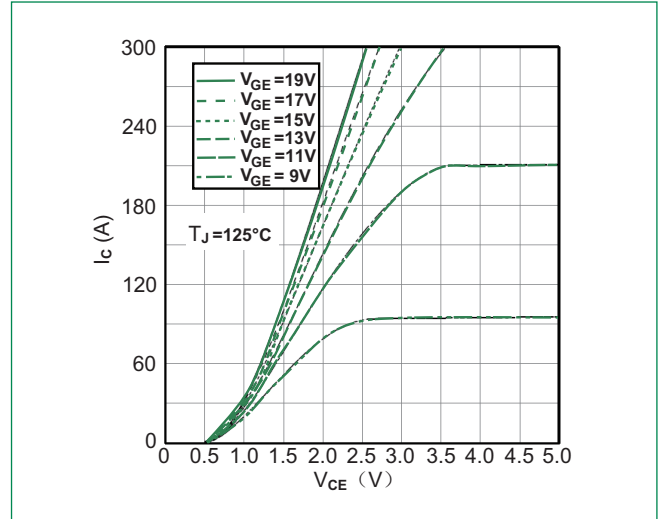

Figure 3: Typical Transfer Characteristics for IGBT Inverter

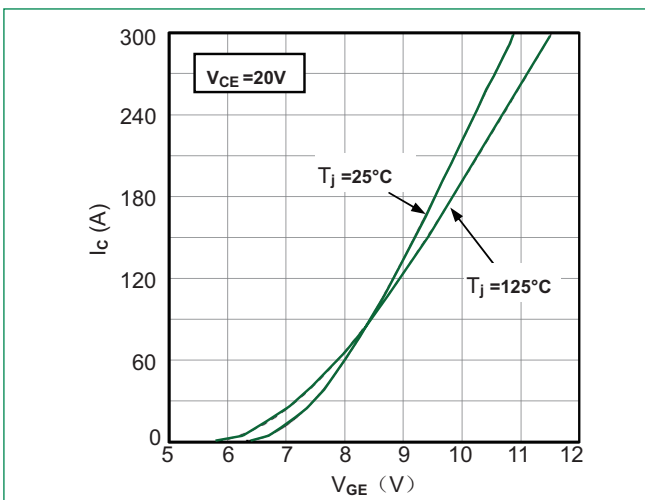

Figure 4: Switching Energy vs. Gate Resistor for IGBT Inverter

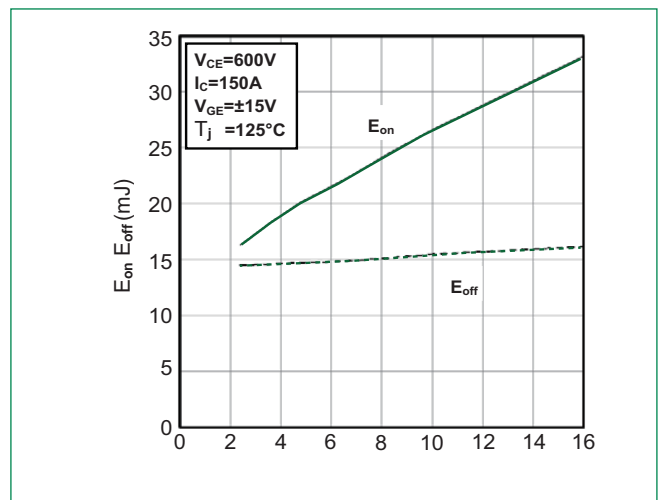

Figure 5: Switching Energy vs. Collector Current for IGBT Inverter

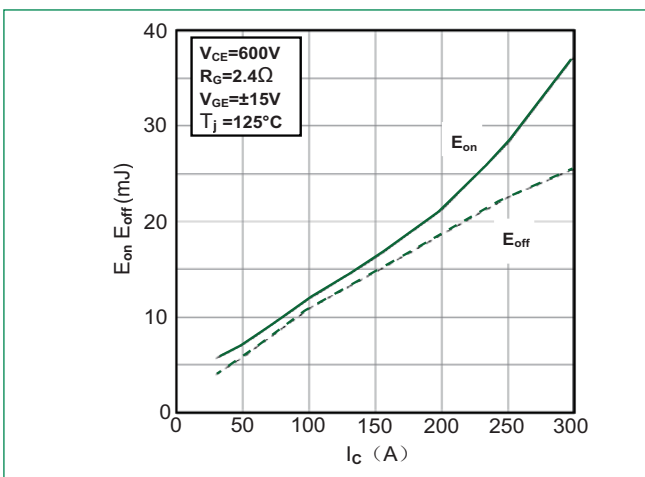

Figure 6: Reverse Biased Safe Operating Area for IGBT Inverter

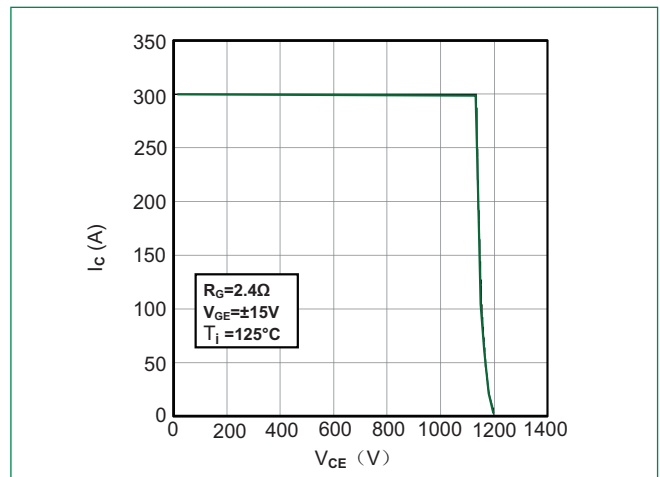

Figure 7: Diode Forward Characteristics for Diode Inverter

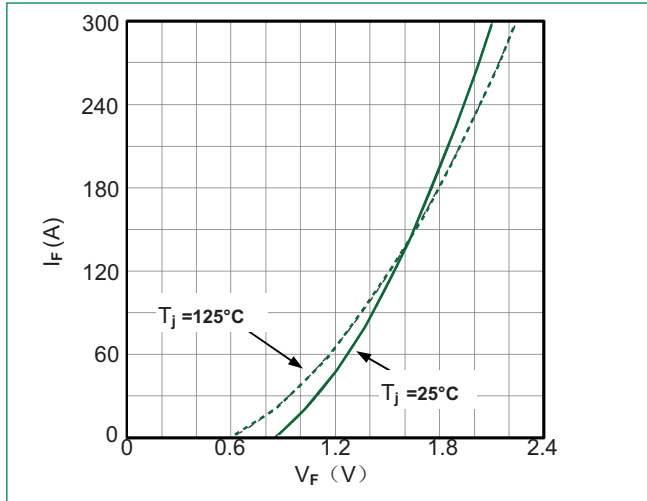

Figure 8: Switching Energy vs. Gate Resistort for Diode Inverter

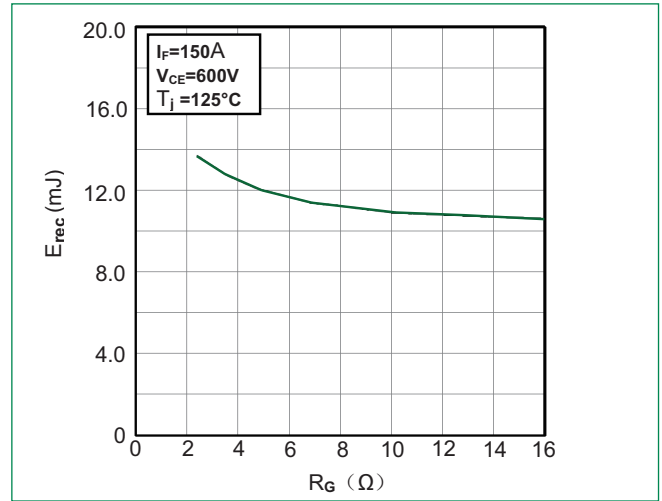

Figure 9: Switching Energy vs. Forward Current for Diode Inverter

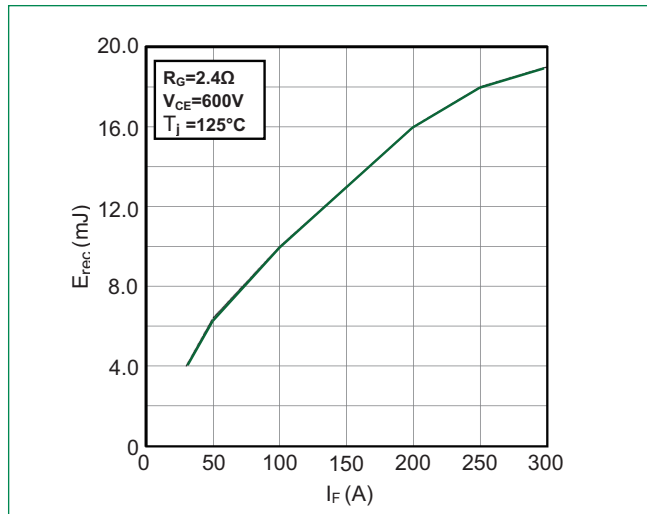

Figure 10: Transient Thermal Impedance of Diode and IGBT Inverter

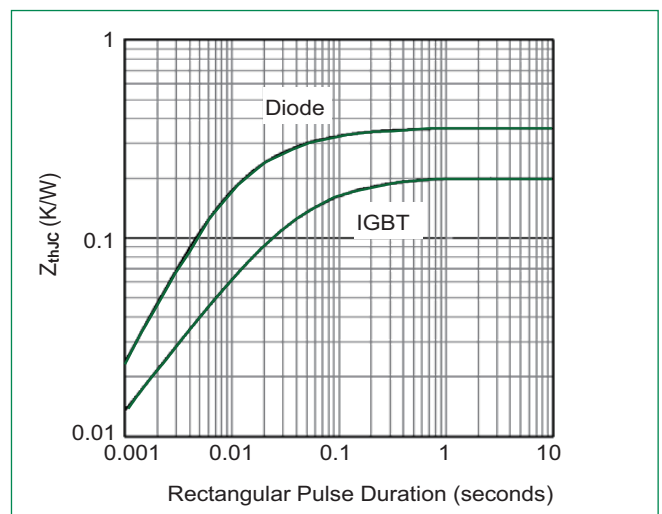
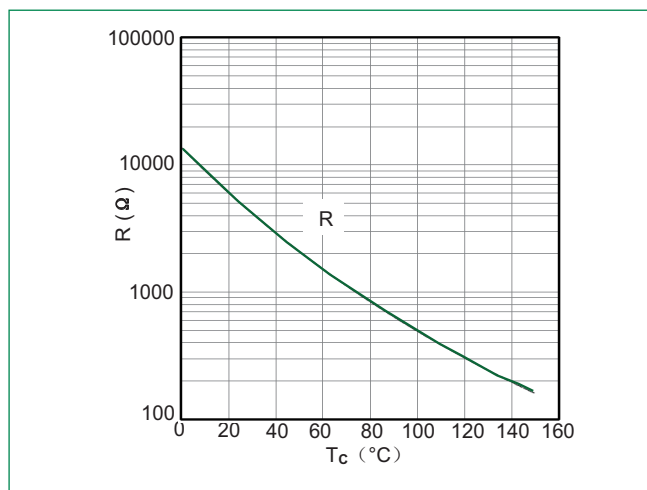
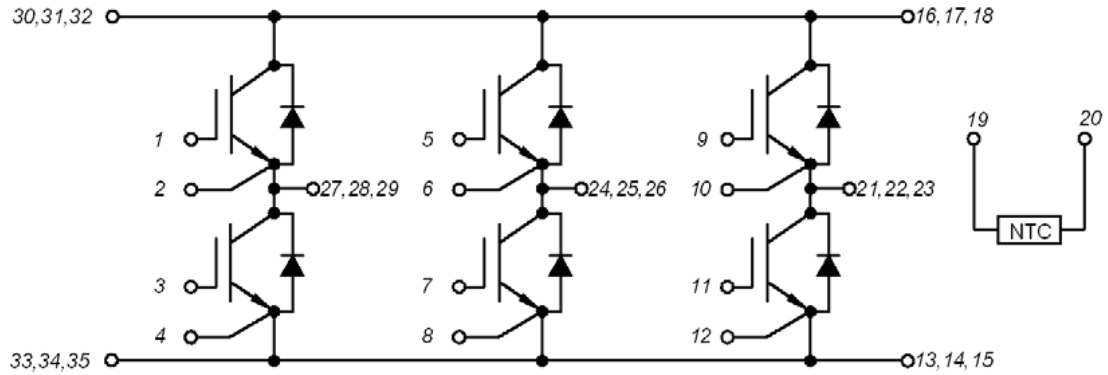

Figure 11: NTC Characteristics



Circuit Diagram



Part Numbering System

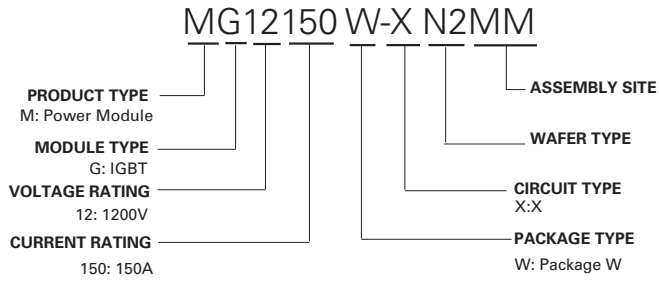

Part Marking System

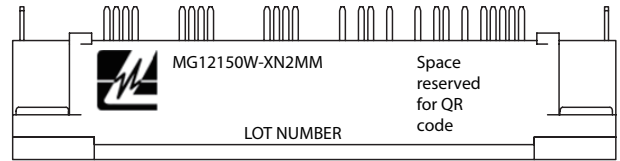

Packing Options

Part Number	Marking	Weight	Packing Mode	M.O.Q
MG12150W-XN2MM	MG12150W-XN2MM	300g	Bulk Pack	20

Dimensions-Package W

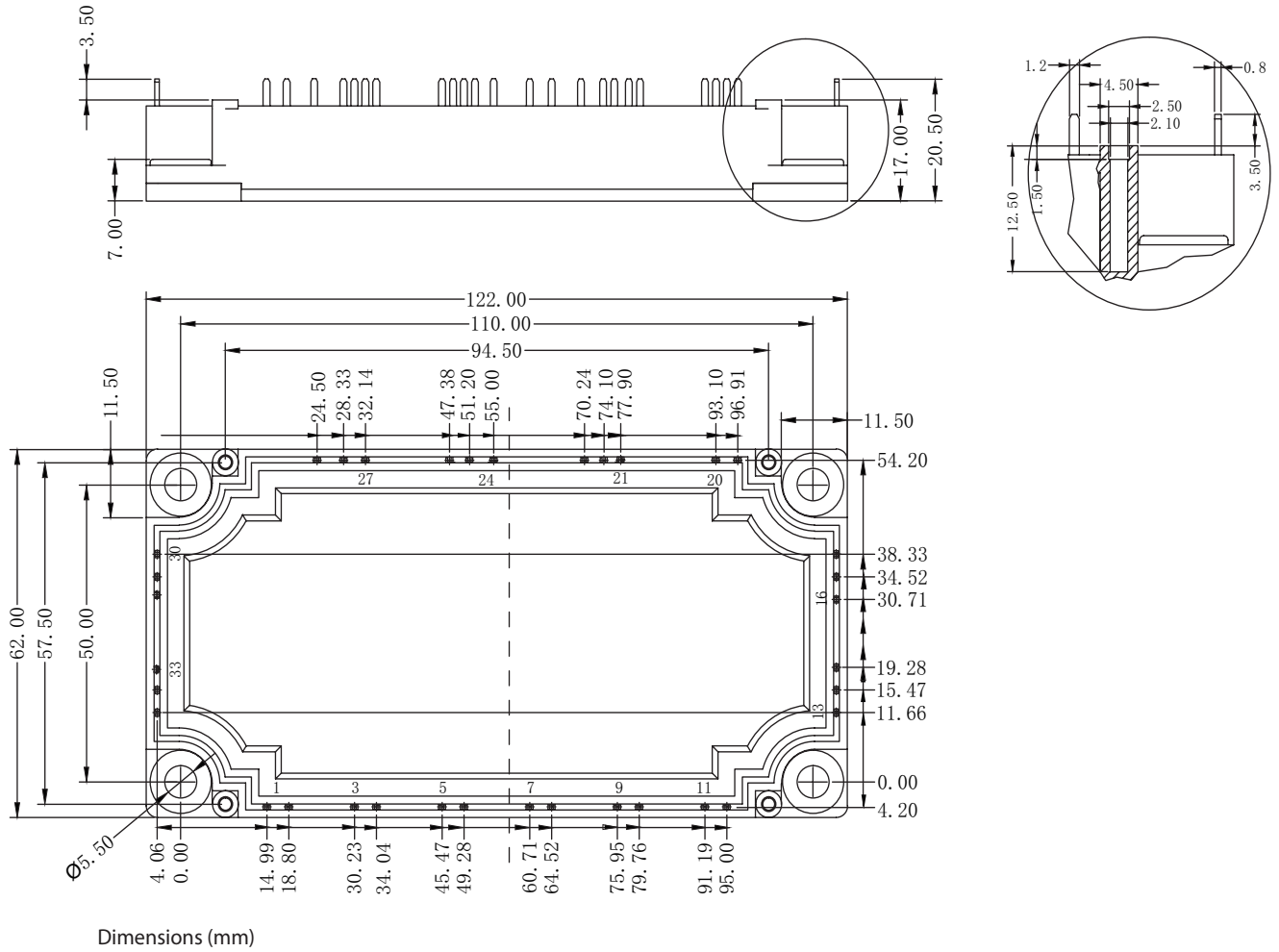

Данный компонент на территории Российской Федерации

Вы можете приобрести в компании MosChip.

Для оперативного оформления запроса Вам необходимо перейти по данной ссылке:

<http://moschip.ru/get-element>

Вы можете разместить у нас заказ для любого Вашего проекта, будь то серийное производство или разработка единичного прибора.

В нашем ассортименте представлены ведущие мировые производители активных и пассивных электронных компонентов.

Нашей специализацией является поставка электронной компонентной базы двойного назначения, продукции таких производителей как XILINX, Intel (ex.ALTERA), Vicor, Microchip, Texas Instruments, Analog Devices, Mini-Circuits, Amphenol, Glenair.

Сотрудничество с глобальными дистрибьюторами электронных компонентов, предоставляет возможность заказывать и получать с международных складов практически любой перечень компонентов в оптимальные для Вас сроки.

На всех этапах разработки и производства наши партнеры могут получить квалифицированную поддержку опытных инженеров.

Система менеджмента качества компании отвечает требованиям в соответствии с ГОСТ Р ИСО 9001, ГОСТ РВ 0015-002 и ЭС РД 009

Офис по работе с юридическими лицами:

105318, г.Москва, ул.Щербаковская д.3, офис 1107, 1118, ДЦ «Щербаковский»

Телефон: +7 495 668-12-70 (многоканальный)

Факс: +7 495 668-12-70 (доб.304)

E-mail: info@moschip.ru

Skype отдела продаж:

moschip.ru

moschip.ru_4

moschip.ru_6

moschip.ru_9