

Part Number: APA2106SECK

Super Bright Orange

Features

- 2.1mmX0.6mm right angle SMT LED, 1.0mm thickness.
- Low power consumption.
- Wide viewing angle.
- Ideal for backlight and indicator.
- Various colors and lens types available.
- Package: 2000pcs / reel.
- Moisture sensitivity level : level 3.
- RoHS compliant.

Description

The Super Bright Orange device is made with AlGaInP (on GaAs substrate) light emitting diode chip.

Package Dimensions

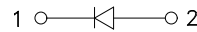
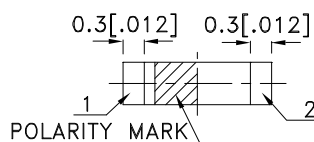
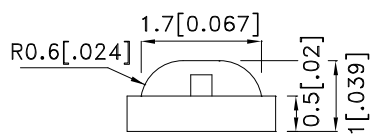

Notes:

1. All dimensions are in millimeters (inches).
2. Tolerance is ± 0.1 (0.004") unless otherwise noted.
3. The specifications, characteristics and technical data described in the datasheet are subject to change without prior notice.
4. The device has a single mounting surface. The device must be mounted according to the specifications



Selection Guide

| Part No. | Dice | Lens Type | Iv (mcd) [2] @ 20mA | | Viewing Angle [1] |
|-------------|-------------------------------|-------------|------------------------|------|----------------------|
| | | | Min. | Typ. | 2θ1/2 |
| APA2106SECK | Super Bright Orange (AlGaInP) | Water Clear | 110 | 250 | 120° |
| | | | *80 | *180 | |

Notes:

1. θ1/2 is the angle from optical centerline where the luminous intensity is 1/2 of the optical peak value.

2. Luminous intensity/ Luminous Flux: +/-15%.

*Luminous intensity value is traceable to the CIE127-2007 compliant national standards

Electrical / Optical Characteristics at TA=25°C

| Symbol | Parameter | Device | Typ. | Max. | Units | Test Conditions |
|--------|--------------------------|---------------------|------|------|-------|-----------------|
| λpeak | Peak Wavelength | Super Bright Orange | 610 | | nm | IF=20mA |
| λD [1] | Dominant Wavelength | Super Bright Orange | 601 | | nm | IF=20mA |
| Δλ1/2 | Spectral Line Half-width | Super Bright Orange | 29 | | nm | IF=20mA |
| C | Capacitance | Super Bright Orange | 15 | | pF | VF=0V;f=1MHz |
| VF [2] | Forward Voltage | Super Bright Orange | 2.1 | 2.5 | V | IF=20mA |
| IR | Reverse Current | Super Bright Orange | | 10 | uA | VR=5V |

Notes:

1.Wavelength: +/-1nm.

2.Forward Voltage: +/-0.1V.

3.Wavelength value is traceable to the CIE127-2007 compliant national standards.

Absolute Maximum Ratings at TA=25°C

| Parameter | Super Bright Orange | Units |
|--------------------------|---------------------|-------|
| Power dissipation | 75 | mW |
| DC Forward Current | 30 | mA |
| Peak Forward Current [1] | 195 | mA |
| Reverse Voltage | 5 | V |
| Operating Temperature | -40°C To +85°C | |
| Storage Temperature | -40°C To +85°C | |

Note:

1. 1/10 Duty Cycle, 0.1ms Pulse Width.



Super Bright Orange APA2106SECK



APA2106SECK

Reflow soldering is recommended and the soldering profile is shown below.
Other soldering methods are not recommended as they might cause damage to the product.

Reflow Soldering Profile For Lead-free SMT Process.



NOTES:

1. We recommend the reflow temperature 245°C(+/-5°C). The maximum soldering temperature should be limited to 260°C.
2. Don't cause stress to the epoxy resin while it is exposed to high temperature.
3. Number of reflow process shall be 2 times or less.

Recommended Soldering Pattern (Units : mm; Tolerance: ± 0.1)



Reel Dimension



Tape Dimensions (Units : mm)

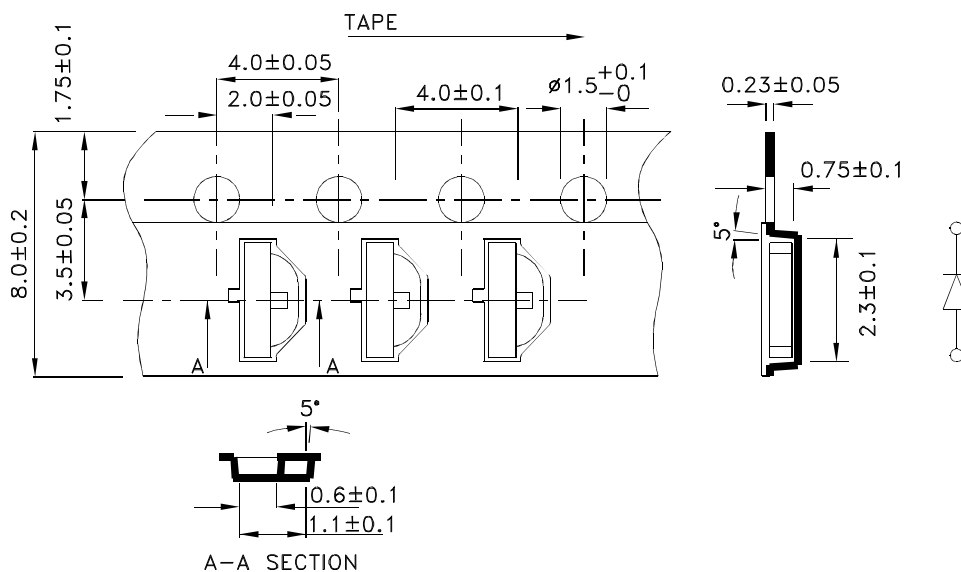

Kingbright

PACKING & LABEL SPECIFICATIONS

APA2106SECK

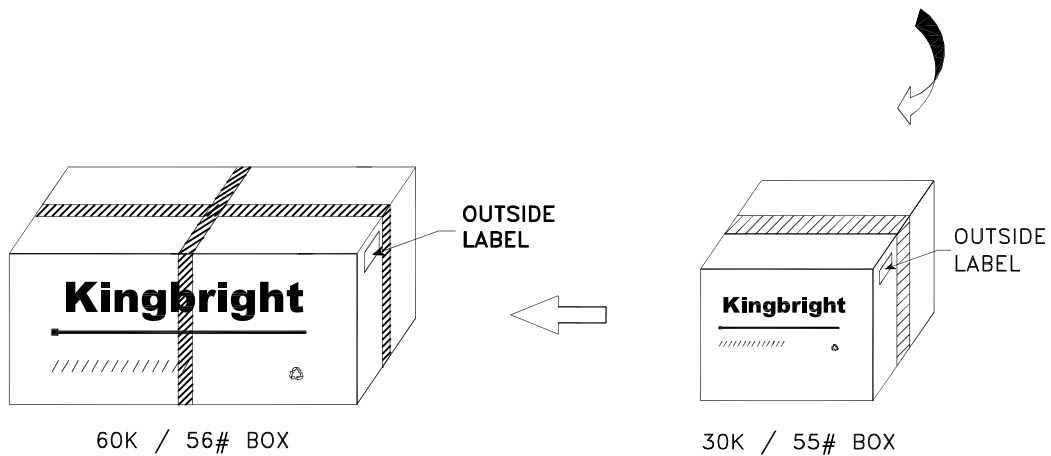
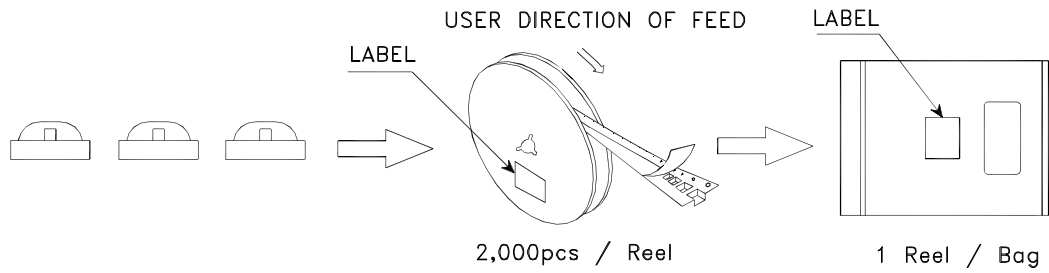

| | | |
|--|------|-----------------------------|
| <h1>Kingbright</h1> | | |
| P/NO: APA2106xxx | | |
| QTY: 2,000 pcs | Q.C. | Q C XX XX XXXX PASSED |
| S/N: XXXX | | |
| CODE: XXX | | |
| LOT NO: | | |
|  XXXXXXXXXXXXXXXXXXXXXXXX | | |
| RoHS Compliant | | |

Данный компонент на территории Российской Федерации

Вы можете приобрести в компании MosChip.

Для оперативного оформления запроса Вам необходимо перейти по данной ссылке:

<http://moschip.ru/get-element>

Вы можете разместить у нас заказ для любого Вашего проекта, будь то серийное производство или разработка единичного прибора.

В нашем ассортименте представлены ведущие мировые производители активных и пассивных электронных компонентов.

Нашей специализацией является поставка электронной компонентной базы двойного назначения, продукции таких производителей как XILINX, Intel (ex.ALTERA), Vicor, Microchip, Texas Instruments, Analog Devices, Mini-Circuits, Amphenol, Glenair.

Сотрудничество с глобальными дистрибьюторами электронных компонентов, предоставляет возможность заказывать и получать с международных складов практически любой перечень компонентов в оптимальные для Вас сроки.

На всех этапах разработки и производства наши партнеры могут получить квалифицированную поддержку опытных инженеров.

Система менеджмента качества компании отвечает требованиям в соответствии с ГОСТ Р ИСО 9001, ГОСТ РВ 0015-002 и ЭС РД 009

Офис по работе с юридическими лицами:

105318, г.Москва, ул.Щербаковская д.3, офис 1107, 1118, ДЦ «Щербаковский»

Телефон: +7 495 668-12-70 (многоканальный)

Факс: +7 495 668-12-70 (доб.304)

E-mail: info@moschip.ru

Skype отдела продаж:

moschip.ru

moschip.ru_4

moschip.ru_6

moschip.ru_9