

FEATURES

High common-mode transient immunity: 100 kV/μs
 High robustness to radiated and conducted noise
 Low propagation delay

- 13 ns maximum for 5 V operation
- 15 ns maximum for 1.8 V operation

150 Mbps maximum guaranteed data rate

Safety and regulatory approvals

- UL recognition: 5000 V rms for 1 minute per UL 1577
- CSA Component Acceptance Notice 5A
- VDE certificate of conformity
- DIN V VDE V 0884-10 (VDE V 0884-10):2006-12
- $V_{IORM} = 849$ V peak
- 8000 V peak reinforced surge isolation voltage
- CQC certification per GB4943.1-2011

Backward compatibility

- ADuM240E1/ADuM241E1/ADuM242E1 pin compatible with ADuM2400/ADuM2401/ADuM2402

Low dynamic power consumption

1.8 V to 5 V level translation
 High temperature operation: 125°C

Fail-safe high or low options
 16-lead, RoHS compliant, SOIC package
 Qualified for automotive applications

APPLICATIONS

General-purpose multichannel isolation
 Serial peripheral interface (SPI)/data converter isolation
 Industrial field bus isolation

GENERAL DESCRIPTION

The ADuM240D/ADuM240E/ADuM241D/ADuM241E/ADuM242D/ADuM242E¹ are quad-channel digital isolators based on Analog Devices, Inc., iCoupler® technology. Combining high speed, complementary metal-oxide semiconductor (CMOS) and monolithic air core transformer technology, these isolation components provide outstanding performance characteristics superior to alternatives such as optocoupler devices and other integrated couplers. The maximum propagation delay is 13 ns with a pulse width distortion of less than 3 ns at 5 V operation. Channel matching is tight at 3.0 ns maximum.

The ADuM240D/ADuM240E/ADuM241D/ADuM241E/ADuM242D/ADuM242E data channels are independent and are available in a variety of configurations with a withstand voltage rating of 5.0 kV rms (see the Ordering Guide). The devices operate with the supply voltage on either side ranging from 1.8 V to 5 V, providing compatibility with lower voltage

¹ Protected by U.S. Patents 5,952,849; 6,873,065; 6,903,578; and 7,075,329. Other patents are pending.

Rev. D **Document Feedback**
 Information furnished by Analog Devices is believed to be accurate and reliable. However, no responsibility is assumed by Analog Devices for its use, nor for any infringements of patents or other rights of third parties that may result from its use. Specifications subject to change without notice. No license is granted by implication or otherwise under any patent or patent rights of Analog Devices. Trademarks and registered trademarks are the property of their respective owners.

FUNCTIONAL BLOCK DIAGRAMS

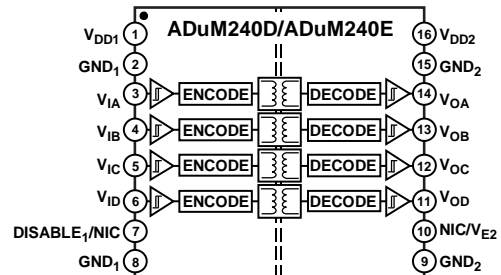

NOTES
 1. NIC = NO INTERNAL CONNECTION. LEAVE THIS PIN FLOATING.
 2. PIN 7 IS DISABLE₁ AND PIN 10 IS NIC FOR THE ADuM240D, AND PIN 7 IS NIC AND PIN 10 IS VE₂ FOR THE ADuM240E.

Figure 1. ADuM240D/ADuM240E Functional Block Diagram

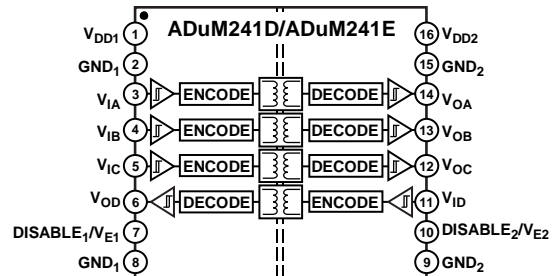

NOTES
 1. PIN 7 IS DISABLE₁ AND PIN 10 IS DISABLE₂ FOR THE ADuM241D, AND PIN 7 IS VE₁ AND PIN 10 IS VE₂ FOR THE ADuM241E.

Figure 2. ADuM241D/ADuM241E Functional Block Diagram

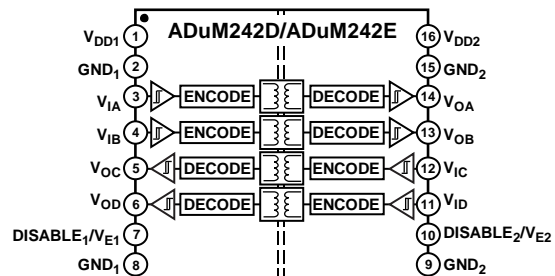

NOTES
 1. PIN 7 IS DISABLE₁ AND PIN 10 IS DISABLE₂ FOR THE ADuM242D, AND PIN 7 IS VE₁ AND PIN 10 IS VE₂ FOR THE ADuM242E.

Figure 3. ADuM242D/ADuM242E Functional Block Diagram

systems as well as enabling voltage translation functionality across the isolation barrier.

Unlike other optocoupler alternatives, dc correctness is ensured in the absence of input logic transitions. Two different fail-safe options are available, by which the outputs transition to a predetermined state when the input power supply is not applied or the inputs are disabled. The ADuM240E1/ADuM241E1/ADuM242E1 are pin compatible with the ADuM2400/ADuM2401/ADuM2402.

TABLE OF CONTENTS

Features	1	Recommended Operating Conditions	13
Applications	1	Absolute Maximum Ratings	14
General Description	1	ESD Caution.....	14
Functional Block Diagrams.....	1	Pin Configurations and Function Descriptions	16
Revision History	2	Typical Performance Characteristics	19
Specifications.....	3	Theory of Operation	21
Electrical Characteristics—5 V Operation.....	3	Applications Information	22
Electrical Characteristics—3.3 V Operation	5	PCB Layout	22
Electrical Characteristics—2.5 V Operation	7	Propagation Delay Related Parameters	22
Electrical Characteristics—1.8 V Operation	9	Jitter Measurement.....	22
Insulation and Safety Related Specifications	11	Insulation Lifetime.....	22
Package Characteristics	11	Outline Dimensions	24
Regulatory Information.....	12	Ordering Guide	24
DIN V VDE V 0884-10 (VDE V 0884-10) Insulation		Automotive Products.....	26
Characteristics	13		

REVISION HISTORY

11/2018—Rev. C to Rev. D

Changes to Table 12 and Table 13	12
--	----

4/2018—Rev. B to Rev. C

Change to Features Section	1
Changes to Table 12 and Table 13	12
Changes to Ordering Guide	24
Changes to Automotive Products Section.....	26

3/2018—Rev. A to Rev. B

Updated Outline Dimensions	24
Changes to Ordering Guide	24
Change to Automotive Products Section	26

4/2016—Rev. 0 to Rev. A

Added RI-16-2	Universal
Changes to Features Section	1
Changes to Table 1.....	3
Changes to Table 3.....	5
Changes to Table 5.....	7
Changes to Table 7.....	9
Added Table 10; Renumbered Sequentially	11
Added Table 13	12
Added Table 18	14
Updated Outline Dimensions	23
Added Figure 26	24
Changes to Ordering Guide	24
Added Automotive Products Section	26

9/2015—Revision 0: Initial Version

SPECIFICATIONS

ELECTRICAL CHARACTERISTICS—5 V OPERATION

All typical specifications are at $T_A = 25^\circ\text{C}$, $V_{DD1} = V_{DD2} = 5\text{ V}$. Minimum/maximum specifications apply over the entire recommended operation range of $4.5\text{ V} \leq V_{DD1} \leq 5.5\text{ V}$, $4.5\text{ V} \leq V_{DD2} \leq 5.5\text{ V}$, and $-40^\circ\text{C} \leq T_A \leq +125^\circ\text{C}$, unless otherwise noted. Switching specifications are tested with $C_L = 15\text{ pF}$ and CMOS signal levels, unless otherwise noted. Supply currents are specified with 50% duty cycle signals.

Table 1.

Parameter	Symbol	Min	Typ	Max	Unit	Test Conditions/Comments
SWITCHING SPECIFICATIONS						
Pulse Width	PW	6.6			ns	Within pulse width distortion (PWD) limit
Data Rate ¹		150			Mbps	Within PWD limit
Propagation Delay	t_{PHL} , t_{PLH}	4.8	7.2	13	ns	50% input to 50% output
Pulse Width Distortion	PWD		0.5	3	ns	$ t_{PLH} - t_{PHL} $
Change vs. Temperature			1.5		ps/°C	
Propagation Delay Skew	t_{PSK}			6.1	ns	Between any two units at the same temperature, voltage, and load
Channel Matching						
Codirectional	t_{PSKCD}		0.5	3.0	ns	
Opposing Direction	t_{PSKOD}		0.5	3.0	ns	
Jitter			490		ps p-p	See the Jitter Measurement section
			70		ps rms	See the Jitter Measurement section
DC SPECIFICATIONS						
Input Threshold Voltage						
Logic High	V_{IH}	$0.7 \times V_{DDx}$			V	
Logic Low	V_{IL}			$0.3 \times V_{DDx}$	V	
Output Voltage						
Logic High	V_{OH}	$V_{DDx} - 0.1$	V_{DDx}		V	$I_{Ox}^2 = -20\text{ }\mu\text{A}$, $V_{ix} = V_{ixH}^3$
		$V_{DDx} - 0.4$	$V_{DDx} - 0.2$		V	$I_{Ox}^2 = -4\text{ mA}$, $V_{ix} = V_{ixH}^3$
Logic Low	V_{OL}		0.0	0.1	V	$I_{Ox}^2 = 20\text{ }\mu\text{A}$, $V_{ix} = V_{ixL}^4$
			0.2	0.4	V	$I_{Ox}^2 = 4\text{ mA}$, $V_{ix} = V_{ixL}^4$
Input Current per Channel	I_i	-10	+0.01	+10	μA	$0\text{ V} \leq V_{ix} \leq V_{DDx}$
V_{E2} Enable Input Pull-Up Current	I_{PU}	-10	-3		μA	$V_{E2} = 0\text{ V}$
DISABLE ₁ Input Pull-Down Current	I_{PD}		9	15	μA	DISABLE ₁ = V_{DDx}
Tristate Output Current per Channel	I_{OZ}	-10	+0.01	+10	μA	$0\text{ V} \leq V_{Ox} \leq V_{DDx}$
Quiescent Supply Current						
ADuM240D/ADuM240E						
	$I_{DD1(Q)}$		1.2	2.2	mA	$V_i^5 = 0$ (E0, D0), 1 (E1, D1) ⁶
	$I_{DD2(Q)}$		2.0	2.72	mA	$V_i^5 = 0$ (E0, D0), 1 (E1, D1) ⁶
	$I_{DD1(Q)}$		12.0	20.0	mA	$V_i^5 = 1$ (E0, D0), 0 (E1, D1) ⁶
	$I_{DD2(Q)}$		2.0	2.92	mA	$V_i^5 = 1$ (E0, D0), 0 (E1, D1) ⁶
ADuM241D/ADuM241E						
	$I_{DD1(Q)}$		1.6	2.46	mA	$V_i^5 = 0$ (E0, D0), 1 (E1, D1) ⁶
	$I_{DD2(Q)}$		1.9	2.62	mA	$V_i^5 = 0$ (E0, D0), 1 (E1, D1) ⁶
	$I_{DD1(Q)}$		10.0	17.0	mA	$V_i^5 = 1$ (E0, D0), 0 (E1, D1) ⁶
	$I_{DD2(Q)}$		6.0	10.0	mA	$V_i^5 = 1$ (E0, D0), 0 (E1, D1) ⁶
ADuM242D/ADuM242E						
	$I_{DD1(Q)}$		1.6	2.46	mA	$V_i^5 = 0$ (E0, D0), 1 (E1, D1) ⁶
	$I_{DD2(Q)}$		1.6	2.46	mA	$V_i^5 = 0$ (E0, D0), 1 (E1, D1) ⁶
	$I_{DD1(Q)}$		7.0	11.5	mA	$V_i^5 = 1$ (E0, D0), 0 (E1, D1) ⁶
	$I_{DD2(Q)}$		7.0	11.5	mA	$V_i^5 = 1$ (E0, D0), 0 (E1, D1) ⁶
Dynamic Supply Current						
Dynamic Input	$I_{DD1(D)}$		0.01		mA/Mbps	Inputs switching, 50% duty cycle
Dynamic Output	$I_{DDO(D)}$		0.02		mA/Mbps	Inputs switching, 50% duty cycle

Parameter	Symbol	Min	Typ	Max	Unit	Test Conditions/Comments
Undervoltage Lockout	UVLO					
Positive V_{DDx} Threshold	V_{DDxUV+}		1.6		V	
Negative V_{DDx} Threshold	V_{DDxUV-}		1.5		V	
V_{DDx} Hysteresis	V_{DDxUVH}		0.1		V	
AC SPECIFICATIONS						
Output Rise/Fall Time	t_r/t_f		2.5		ns	10% to 90%
Common-Mode Transient Immunity ⁷	$ CM_H $	75	100		kV/ μ s	$V_{ix} = V_{DDx}$, $V_{CM} = 1000$ V, transient magnitude = 800 V
	$ CM_L $	75	100		kV/ μ s	$V_{ix} = 0$ V, $V_{CM} = 1000$ V, transient magnitude = 800 V

¹ 150 Mbps is the highest data rate that can be guaranteed, although higher data rates are possible.

² I_{Ox} is the Channel x output current, where x = A, B, C, or D.

³ V_{IH} is the input side logic high.

⁴ V_{IL} is the input side logic low.

⁵ V_i is the voltage input.

⁶ E0 is the ADuM240E0/ADuM241E0/ADuM242E0 models, D0 is the ADuM240D0/ADuM241D0/ADuM242D0 models, E1 is the ADuM240E1/ADuM241E1/ADuM242E1 models, and D1 is the ADuM240D1/ADuM241D1/ADuM242D1 models. See the Ordering Guide section.

⁷ $|CM_H|$ is the maximum common-mode voltage slew rate that can be sustained while maintaining the voltage output (V_o) > 0.8 V_{DDx} . $|CM_L|$ is the maximum common-mode voltage slew rate that can be sustained while maintaining $V_o > 0.8$ V. The common-mode voltage slew rates apply to both rising and falling common-mode voltage edges.

Table 2. Total Supply Current vs. Data Throughput

Parameter	Symbol	1 Mbps			25 Mbps			100 Mbps			Unit
		Min	Typ	Max	Min	Typ	Max	Min	Typ	Max	
SUPPLY CURRENT											
ADuM240D/ADuM240E											
Supply Current Side 1	I_{DD1}		6.8	10		7.8	12		11.8	17.4	mA
Supply Current Side 2	I_{DD2}		2.1	3.7		3.9	5.7		9.2	13	mA
ADuM241D/ADuM241E											
Supply Current Side 1	I_{DD1}		5.8	10.3		7.0	10.9		11.4	15.9	mA
Supply Current Side 2	I_{DD2}		4.0	6.85		5.5	8.5		10.3	14.0	mA
ADuM242D/ADuM242E											
Supply Current Side 1	I_{DD1}		4.3	7.7		6.0	9.3		10.3	14.2	mA
Supply Current Side 2	I_{DD2}		5.3	8.7		6.7	10.1		11.0	14.9	mA

ELECTRICAL CHARACTERISTICS—3.3 V OPERATION

All typical specifications are at $T_A = 25^\circ\text{C}$, $V_{DD1} = V_{DD2} = 3.3\text{ V}$. Minimum/maximum specifications apply over the entire recommended operation range: $3.0\text{ V} \leq V_{DD1} \leq 3.6\text{ V}$, $3.0\text{ V} \leq V_{DD2} \leq 3.6\text{ V}$, and $-40^\circ\text{C} \leq T_A \leq +125^\circ\text{C}$, unless otherwise noted. Switching specifications are tested with $C_L = 15\text{ pF}$ and CMOS signal levels, unless otherwise noted. Supply currents are specified with 50% duty cycle signals.

Table 3.

Parameter	Symbol	Min	Typ	Max	Unit	Test Conditions/Comments
SWITCHING SPECIFICATIONS						
Pulse Width	PW	6.6			ns	Within PWD limit
Data Rate ¹		150			Mbps	Within PWD limit
Propagation Delay	t_{PHL} , t_{PLH}	4.8	6.8	14	ns	50% input to 50% output
Pulse Width Distortion	PWD		0.7	3	ns	$ t_{PLH} - t_{PHL} $
Change vs. Temperature			1.5		ps/ $^\circ\text{C}$	
Propagation Delay Skew	t_{PSK}			7.5	ns	Between any two units at the same temperature, voltage, and load
Channel Matching						
Codirectional	t_{PSKCD}		0.7	3.0	ns	
Opposing Direction	t_{PSKOD}		0.7	3.0	ns	
Jitter			580		ps p-p	See the Jitter Measurement section
			120		ps rms	See the Jitter Measurement section
DC SPECIFICATIONS						
Input Threshold Voltage						
Logic High	V_{IH}	$0.7 \times V_{DDx}$			V	
Logic Low	V_{IL}			$0.3 \times V_{DDx}$	V	
Output Voltage						
Logic High	V_{OH}	$V_{DDx} - 0.1$	V_{DDx}		V	$I_{Ox}^2 = -20\ \mu\text{A}$, $V_{Ix} = V_{IxH}^3$
		$V_{DDx} - 0.4$	$V_{DDx} - 0.2$		V	$I_{Ox}^2 = -2\ \text{mA}$, $V_{Ix} = V_{IxH}^3$
Logic Low	V_{OL}		0.0	0.1	V	$I_{Ox}^2 = 20\ \mu\text{A}$, $V_{Ix} = V_{IxL}^4$
			0.2	0.4	V	$I_{Ox}^2 = 2\ \text{mA}$, $V_{Ix} = V_{IxL}^4$
Input Current per Channel	I_i	-10	+0.01	+10	μA	$0\text{ V} \leq V_{Ix} \leq V_{DDx}$
V_{E2} Enable Input Pull-Up Current	I_{PU}	-10	-3		μA	$V_{E2} = 0\text{ V}$
DISABLE ₁ Input Pull-Down Current	I_{PD}		9	15	μA	DISABLE ₁ = V_{DDx}
Tristate Output Current per Channel	I_{OZ}	-10	+0.01	+10	μA	$0\text{ V} \leq V_{Ox} \leq V_{DDx}$
Quiescent Supply Current						
ADuM240D/ADuM240E	$I_{DD1(Q)}$		1.2	2.12	mA	$V_i^5 = 0$ (E0, D0), 1 (E1, D1) ⁶
	$I_{DD2(Q)}$		2.0	2.68	mA	$V_i^5 = 0$ (E0, D0), 1 (E1, D1) ⁶
	$I_{DD1(Q)}$		12.0	19.6	mA	$V_i^5 = 1$ (E0, D0), 0 (E1, D1) ⁶
	$I_{DD2(Q)}$		2.0	2.8	mA	$V_i^5 = 1$ (E0, D0), 0 (E1, D1) ⁶
ADuM241D/ADuM241E	$I_{DD1(Q)}$		1.5	2.36	mA	$V_i^5 = 0$ (E0, D0), 1 (E1, D1) ⁶
	$I_{DD2(Q)}$		1.8	2.52	mA	$V_i^5 = 0$ (E0, D0), 1 (E1, D1) ⁶
	$I_{DD1(Q)}$		9.8	16.7	mA	$V_i^5 = 1$ (E0, D0), 0 (E1, D1) ⁶
	$I_{DD2(Q)}$		5.7	9.7	mA	$V_i^5 = 1$ (E0, D0), 0 (E1, D1) ⁶
ADuM242D/ADuM242E	$I_{DD1(Q)}$		1.6	2.4	mA	$V_i^5 = 0$ (E0, D0), 1 (E1, D1) ⁶
	$I_{DD2(Q)}$		1.6	2.4	mA	$V_i^5 = 0$ (E0, D0), 1 (E1, D1) ⁶
	$I_{DD1(Q)}$		7.0	11.2	mA	$V_i^5 = 1$ (E0, D0), 0 (E1, D1) ⁶
	$I_{DD2(Q)}$		7.0	11.2	mA	$V_i^5 = 1$ (E0, D0), 0 (E1, D1) ⁶
Dynamic Supply Current						
Dynamic Input	$I_{DDI(D)}$		0.01		mA/Mbps	Inputs switching, 50% duty cycle
Dynamic Output	$I_{DDO(D)}$		0.01		mA/Mbps	Inputs switching, 50% duty cycle

Parameter	Symbol	Min	Typ	Max	Unit	Test Conditions/Comments
Undervoltage Lockout	UVLO					
Positive V_{DDx} Threshold	V_{DDxUV+}		1.6		V	
Negative V_{DDx} Threshold	V_{DDxUV-}		1.5		V	
V_{DDx} Hysteresis	V_{DDxUVH}		0.1		V	
AC SPECIFICATIONS						
Output Rise/Fall Time	t_R/t_F		2.5		ns	10% to 90%
Common-Mode Transient Immunity ⁷	$ CM_H $	75	100		kV/ μ s	$V_{IX} = V_{DDx}$, $V_{CM} = 1000$ V, transient magnitude = 800 V
	$ CM_L $	75	100		kV/ μ s	$V_{IX} = 0$ V, $V_{CM} = 1000$ V, transient magnitude = 800 V

¹ 150 Mbps is the highest data rate that can be guaranteed, although higher data rates are possible.

² I_{Ox} is the Channel x output current, where x = A, B, C, or D.

³ V_{IH} is the input side logic high.

⁴ V_{IL} is the input side logic low.

⁵ V_i is the voltage input.

⁶ E0 is the ADuM240E0/ADuM241E0/ADuM242E0 models, D0 is the ADuM240D0/ADuM241D0/ADuM242D0 models, E1 is the ADuM240E1/ADuM241E1/ADuM242E1 models, and D1 is the ADuM240D1/ADuM241D1/ADuM242D1 models. See the Ordering Guide section.

⁷ $|CM_H|$ is the maximum common-mode voltage slew rate that can be sustained while maintaining $V_O > 0.8 V_{DDx}$. $|CM_L|$ is the maximum common-mode voltage slew rate that can be sustained while maintaining $V_O > 0.8$ V. The common-mode voltage slew rates apply to both rising and falling common-mode voltage edges.

Table 4. Total Supply Current vs. Data Throughput

Parameter	Symbol	1 Mbps			25 Mbps			100 Mbps			Unit
		Min	Typ	Max	Min	Typ	Max	Min	Typ	Max	
SUPPLY CURRENT											
ADuM240D/ADuM240E											
Supply Current Side 1	I_{DD1}		6.6	9.8		7.4	11.2		10.7	15.9	mA
Supply Current Side 2	I_{DD2}		2.0	3.7		3.5	5.5		8.2	11.6	mA
ADuM241D/ADuM241E											
Supply Current Side 1	I_{DD1}		5.65	10.1		6.65	10.5		10.4	14.9	mA
Supply Current Side 2	I_{DD2}		3.9	6.65		5.2	8.0		9.4	12.8	mA
ADuM242D/ADuM242E											
Supply Current Side 1	I_{DD1}		4.3	7.7		5.6	9.0		9.1	13	mA
Supply Current Side 2	I_{DD2}		5.0	8.4		6.2	9.6		9.8	13.7	mA

ELECTRICAL CHARACTERISTICS—2.5 V OPERATION

All typical specifications are at $T_A = 25^\circ\text{C}$, $V_{DD1} = V_{DD2} = 2.5\text{ V}$. Minimum/maximum specifications apply over the entire recommended operation range: $2.25\text{ V} \leq V_{DD1} \leq 2.75\text{ V}$, $2.25\text{ V} \leq V_{DD2} \leq 2.75\text{ V}$, $-40^\circ\text{C} \leq T_A \leq +125^\circ\text{C}$, unless otherwise noted. Switching specifications are tested with $C_L = 15\text{ pF}$ and CMOS signal levels, unless otherwise noted. Supply currents are specified with 50% duty cycle signals.

Table 5.

Parameter	Symbol	Min	Typ	Max	Unit	Test Conditions/Comments
SWITCHING SPECIFICATIONS						
Pulse Width	PW	6.6			ns	Within PWD limit
Data Rate ¹		150			Mbps	Within PWD limit
Propagation Delay	t_{PHL} , t_{PLH}	5.0	7.0	14	ns	50% input to 50% output
Pulse Width Distortion	PWD		0.7	3	ns	$ t_{PLH} - t_{PHL} $
Change vs. Temperature			1.5		ps/ $^\circ\text{C}$	
Propagation Delay Skew	t_{PSK}			6.8	ns	Between any two units at the same temperature, voltage, and load
Channel Matching						
Codirectional	t_{PSKCD}		0.7	3.0	ns	
Opposing Direction	t_{PSKOD}		0.7	3.0	ns	
Jitter			800		ps p-p	See the Jitter Measurement section
			190		ps rms	See the Jitter Measurement section
DC SPECIFICATIONS						
Input Threshold Voltage						
Logic High	V_{IH}	$0.7 \times V_{DDx}$			V	
Logic Low	V_{IL}			$0.3 \times V_{DDx}$	V	
Output Voltage						
Logic High	V_{OH}	$V_{DDx} - 0.1$	V_{DDx}		V	$I_{Ox}^2 = -20\ \mu\text{A}$, $V_{Ix} = V_{IxH}^3$
		$V_{DDx} - 0.4$	$V_{DDx} - 0.2$		V	$I_{Ox}^2 = -2\ \text{mA}$, $V_{Ix} = V_{IxH}^3$
Logic Low	V_{OL}		0.0	0.1	V	$I_{Ox}^2 = 20\ \mu\text{A}$, $V_{Ix} = V_{IxL}^4$
			0.2	0.4	V	$I_{Ox}^2 = 2\ \text{mA}$, $V_{Ix} = V_{IxL}^4$
Input Current per Channel	I_I	-10	+0.01	+10	μA	$0\text{ V} \leq V_{Ix} \leq V_{DDx}$
V_{E2} Enable Input Pull-Up Current	I_{PU}	-10	-3		μA	$V_{E2} = 0\text{ V}$
DISABLE ₁ Input Pull-Down Current	I_{PD}		9	15	μA	DISABLE ₁ = V_{DDx}
Tristate Output Current per Channel	I_{OZ}	-10	+0.01	+10	μA	$0\text{ V} \leq V_{Ox} \leq V_{DDx}$
Quiescent Supply Current						
ADuM240D/ADuM240E						
	$I_{DD1(Q)}$		1.2	2.0	mA	$V_I^5 = 0$ (E0, D0), 1 (E1, D1) ⁶
	$I_{DD2(Q)}$		2.0	2.64	mA	$V_I^5 = 0$ (E0, D0), 1 (E1, D1) ⁶
	$I_{DD1(Q)}$		1.2	19.6	mA	$V_I^5 = 1$ (E0, D0), 0 (E1, D1) ⁶
	$I_{DD2(Q)}$		2.0	2.76	mA	$V_I^5 = 1$ (E0, D0), 0 (E1, D1) ⁶
ADuM241D/ADuM241E						
	$I_{DD1(Q)}$		1.46	2.32	mA	$V_I^5 = 0$ (E0, D0), 1 (E1, D1) ⁶
	$I_{DD2(Q)}$		1.75	2.47	mA	$V_I^5 = 0$ (E0, D0), 1 (E1, D1) ⁶
	$I_{DD1(Q)}$		9.7	16.6	mA	$V_I^5 = 1$ (E0, D0), 0 (E1, D1) ⁶
	$I_{DD2(Q)}$		5.67	9.67	mA	$V_I^5 = 1$ (E0, D0), 0 (E1, D1) ⁶
ADuM242D/ADuM242E						
	$I_{DD1(Q)}$		1.6	2.32	mA	$V_I^5 = 0$ (E0, D0), 1 (E1, D1) ⁶
	$I_{DD2(Q)}$		1.6	2.32	mA	$V_I^5 = 0$ (E0, D0), 1 (E1, D1) ⁶
	$I_{DD1(Q)}$		7.0	11.2	mA	$V_I^5 = 1$ (E0, D0), 0 (E1, D1) ⁶
	$I_{DD2(Q)}$		7.0	11.2	mA	$V_I^5 = 1$ (E0, D0), 0 (E1, D1) ⁶
Dynamic Supply Current						
Dynamic Input	$I_{DDI(D)}$		0.01		mA/Mbps	Inputs switching, 50% duty cycle
Dynamic Output	$I_{DDO(D)}$		0.01		mA/Mbps	Inputs switching, 50% duty cycle

Parameter	Symbol	Min	Typ	Max	Unit	Test Conditions/Comments
Undervoltage Lockout						
Positive V_{DDx} Threshold	V_{DDxUV+}		1.6		V	
Negative V_{DDx} Threshold	V_{DDxUV-}		1.5		V	
V_{DDx} Hysteresis	V_{DDxUVH}		0.1		V	
AC SPECIFICATIONS						
Output Rise/Fall Time	t_R/t_F		2.5		ns	10% to 90%
Common-Mode Transient Immunity ⁷	$ CM_H $	75	100		kV/ μ s	$V_{IX} = V_{DDx}$, $V_{CM} = 1000$ V, transient magnitude = 800 V
	$ CM_L $	75	100		kV/ μ s	$V_{IX} = 0$ V, $V_{CM} = 1000$ V, transient magnitude = 800 V

¹ 150 Mbps is the highest data rate that can be guaranteed, although higher data rates are possible.

² I_{Ox} is the Channel x output current, where x = A, B, C, or D.

³ V_{IH} is the input side logic high.

⁴ V_{IL} is the input side logic low.

⁵ V_i is the voltage input.

⁶ E0 is the ADuM240E0/ADuM241E0/ADuM242E0 models, D0 is the ADuM240D0/ADuM241D0/ADuM242D0 models, E1 is the ADuM240E1/ADuM241E1/ADuM242E1 models, and D1 is the ADuM240D1/ADuM241D1/ADuM242D1 models. See the Ordering Guide section.

⁷ $|CM_H|$ is the maximum common-mode voltage slew rate that can be sustained while maintaining the voltage output (V_o) > 0.8 V_{DDx} . $|CM_L|$ is the maximum common-mode voltage slew rate that can be sustained while maintaining V_o > 0.8 V. The common-mode voltage slew rates apply to both rising and falling common-mode voltage edges.

Table 6. Total Supply Current vs. Data Throughput

Parameter	Symbol	1 Mbps			25 Mbps			100 Mbps			Unit
		Min	Typ	Max	Min	Typ	Max	Min	Typ	Max	
SUPPLY CURRENT											
ADuM240D/ADuM240E											
Supply Current Side 1	I_{DD1}		6.5	9.8		7.3	11.1		10.4	15.5	mA
Supply Current Side 2	I_{DD2}		2.0	3.6		3.3	5.2		7.3	10.2	mA
ADuM241D/ADuM241E											
Supply Current Side 1	I_{DD1}		5.6	10.0		6.4	10.4		9.7	14.5	mA
Supply Current Side 2	I_{DD2}		3.8	6.55		4.8	7.7		8.3	11.5	mA
ADuM242D/ADuM242E											
Supply Current Side 1	I_{DD1}		4.3	7.7		5.4	8.8		8.8	12.7	mA
Supply Current Side 2	I_{DD2}		5.0	8.4		6.1	9.5		9.5	13.4	mA

ELECTRICAL CHARACTERISTICS—1.8 V OPERATION

All typical specifications are at $T_A = 25^\circ\text{C}$, $V_{DD1} = V_{DD2} = 1.8\text{ V}$. Minimum/maximum specifications apply over the entire recommended operation range: $1.7\text{ V} \leq V_{DD1} \leq 1.9\text{ V}$, $1.7\text{ V} \leq V_{DD2} \leq 1.9\text{ V}$, and $-40^\circ\text{C} \leq T_A \leq +125^\circ\text{C}$, unless otherwise noted. Switching specifications are tested with $C_L = 15\text{ pF}$ and CMOS signal levels, unless otherwise noted. Supply currents are specified with 50% duty cycle signals.

Table 7.

Parameter	Symbol	Min	Typ	Max	Unit	Test Conditions/Comments
SWITCHING SPECIFICATIONS						
Pulse Width	PW	6.6			ns	Within PWD limit
Data Rate ¹		150			Mbps	Within PWD limit
Propagation Delay	t_{PHL} , t_{PLH}	5.8	8.7	15	ns	50% input to 50% output
Pulse Width Distortion	PWD		0.7	3	ns	$ t_{PLH} - t_{PHL} $
Change vs. Temperature			1.5		ps/°C	
Propagation Delay Skew	t_{PSK}			7.0	ns	Between any two units at the same temperature, voltage, and load
Channel Matching						
Codirectional	t_{PSKCD}		0.7	3.0	ns	
Opposing Direction	t_{PSKOD}		0.7	3.0	ns	
Jitter			470		ps p-p	See the Jitter Measurement section
			70		ps rms	See the Jitter Measurement section
DC SPECIFICATIONS						
Input Threshold Voltage						
Logic High	V_{IH}	$0.7 \times V_{DDx}$			V	
Logic Low	V_{IL}			$0.3 \times V_{DDx}$	V	
Output Voltage						
Logic High	V_{OH}	$V_{DDx} - 0.1$	V_{DDx}		V	$I_{Ox}^2 = -20\ \mu\text{A}$, $V_{Ix} = V_{IxH}^3$
		$V_{DDx} - 0.4$	$V_{DDx} - 0.2$		V	$I_{Ox}^2 = -2\ \text{mA}$, $V_{Ix} = V_{IxH}^3$
Logic Low	V_{OL}		0.0	0.1	V	$I_{Ox}^2 = 20\ \mu\text{A}$, $V_{Ix} = V_{IxL}^4$
			0.2	0.4	V	$I_{Ox}^2 = 2\ \text{mA}$, $V_{Ix} = V_{IxL}^4$
Input Current per Channel	I_I	-10	+0.01	+10	μA	$0\text{ V} \leq V_{Ix} \leq V_{DDx}$
V_{E2} Enable Input Pull-Up Current	I_{PU}	-10	-3		μA	$V_{E2} = 0\text{ V}$
DISABLE ₁ Input Pull-Down Current	I_{PD}		9	15	μA	DISABLE ₁ = V_{DDx}
Tristate Output Current per Channel	I_{OZ}	-10	+0.01	+10	μA	$0\text{ V} \leq V_{Ox} \leq V_{DDx}$
Quiescent Supply Current						
ADuM240D/ADuM240E						
	$I_{DD1(Q)}$		1.2	1.92	mA	$V_I^5 = 0$ (E0, D0), 1 (E1, D1) ⁶
	$I_{DD2(Q)}$		2.0	2.64	mA	$V_I^5 = 0$ (E0, D0), 1 (E1, D1) ⁶
	$I_{DD1(Q)}$		12.0	19.6	mA	$V_I^5 = 1$ (E0, D0), 0 (E1, D1) ⁶
	$I_{DD2(Q)}$		2.0	2.76	mA	$V_I^5 = 1$ (E0, D0), 0 (E1, D1) ⁶
ADuM241D/ADuM241E						
	$I_{DD1(Q)}$		1.4	2.28	mA	$V_I^5 = 0$ (E0, D0), 1 (E1, D1) ⁶
	$I_{DD2(Q)}$		1.73	2.45	mA	$V_I^5 = 0$ (E0, D0), 1 (E1, D1) ⁶
	$I_{DD1(Q)}$		9.6	16.5	mA	$V_I^5 = 1$ (E0, D0), 0 (E1, D1) ⁶
	$I_{DD2(Q)}$		5.6	9.6	mA	$V_I^5 = 1$ (E0, D0), 0 (E1, D1) ⁶
ADuM242D/ADuM242E						
	$I_{DD1(Q)}$		1.6	2.28	mA	$V_I^5 = 0$ (E0, D0), 1 (E1, D1) ⁶
	$I_{DD2(Q)}$		1.6	2.28	mA	$V_I^5 = 0$ (E0, D0), 1 (E1, D1) ⁶
	$I_{DD1(Q)}$		7.0	11.2	mA	$V_I^5 = 1$ (E0, D0), 0 (E1, D1) ⁶
	$I_{DD2(Q)}$		7.0	11.2	mA	$V_I^5 = 1$ (E0, D0), 0 (E1, D1) ⁶
Dynamic Supply Current						
Dynamic Input	$I_{DDI(D)}$		0.01		mA/Mbps	Inputs switching, 50% duty cycle
Dynamic Output	$I_{DDO(D)}$		0.01		mA/Mbps	Inputs switching, 50% duty cycle

Parameter	Symbol	Min	Typ	Max	Unit	Test Conditions/Comments
Undervoltage Lockout	UVLO					
Positive V_{DDx} Threshold	V_{DDxUV+}		1.6		V	
Negative V_{DDx} Threshold	V_{DDxUV-}		1.5		V	
V_{DDx} Hysteresis	V_{DDxUVH}		0.1		V	
AC SPECIFICATIONS						
Output Rise/Fall Time	t_R/t_F		2.5		ns	10% to 90%
Common-Mode Transient Immunity ⁷	$ CM_H $	75	100		kV/ μ s	$V_{IX} = V_{DDx}$, $V_{CM} = 1000$ V, transient magnitude = 800 V
	$ CM_L $	75	100		kV/ μ s	$V_{IX} = 0$ V, $V_{CM} = 1000$ V, transient magnitude = 800 V

¹ 150 Mbps is the highest data rate that can be guaranteed, although higher data rates are possible.

² I_{Ox} is the Channel x output current, where x = A, B, C, or D.

³ V_{IH} is the input side logic high.

⁴ V_{IL} is the input side logic low.

⁵ V_i is the voltage input.

⁶ E0 is the ADuM240E0/ADuM241E0/ADuM242E0 models, D0 is the ADuM240D0/ADuM241D0/ADuM242D0 models, E1 is the ADuM240E1/ADuM241E1/ADuM242E1 models, and D1 is the ADuM240D1/ADuM241D1/ADuM242D1 models. See the Ordering Guide section.

⁷ $|CM_H|$ is the maximum common-mode voltage slew rate that can be sustained while maintaining the voltage output (V_o) > 0.8 V_{DDx} . $|CM_L|$ is the maximum common-mode voltage slew rate that can be sustained while maintaining $V_o > 0.8$ V. The common-mode voltage slew rates apply to both rising and falling common-mode voltage edges.

Table 8. Total Supply Current vs. Data Throughput

Parameter	Symbol	1 Mbps			25 Mbps			100 Mbps			Unit
		Min	Typ	Max	Min	Typ	Max	Min	Typ	Max	
SUPPLY CURRENT											
ADuM240D/ADuM240E											
Supply Current Side 1	I_{DD1}		6.4	9.8		7.2	11		10.2	15.2	mA
Supply Current Side 2	I_{DD2}		1.9	3.5		3.1	5.0		6.8	10	mA
ADuM241D/ADuM240E											
Supply Current Side 1	I_{DD1}		5.5	9.1		6.3	10.0		9.6	14.0	mA
Supply Current Side 2	I_{DD2}		3.72	6.45		4.8	7.5		8.4	11.2	mA
ADuM242D/ADuM242E											
Supply Current Side 1	I_{DD1}		4.3	7.7		5.3	8.7		8.6	12.6	mA
Supply Current Side 2	I_{DD2}		4.9	8.3		6.0	9.4		9.3	13.3	mA

INSULATION AND SAFETY RELATED SPECIFICATIONS

For additional information, see www.analog.com/icouplersafety.

Table 9. RW-16 Wide Body [SOIC_W] Package

Parameter	Symbol	Value	Unit	Test Conditions/Comments
Rated Dielectric Insulation Voltage		5000	V rms	1-minute duration
Minimum External Air Gap (Clearance)	L (I01)	7.8	mm min	Measured from input terminals to output terminals, shortest distance through air
Minimum External Tracking (Creepage)	L (I02)	7.8	mm min	Measured from input terminals to output terminals, shortest distance path along body
Minimum Clearance in the Plane of the Printed Circuit Board (PCB Clearance)	L (PCB)	8.1	mm min	Measured from input terminals to output terminals, shortest distance through air, line of sight, in the PCB mounting plane
Minimum Internal Gap (Internal Clearance)		25.5	µm min	Insulation distance through insulation
Tracking Resistance (Comparative Tracking Index)	CTI	>400	V	DIN IEC 112/VDE 0303 Part 1
Material Group		II		Material Group (DIN VDE 0110, 1/89, Table 1)

Table 10. RI-16 -2 Wide Body Increased Creepage [SOIC_IC] Package

Parameter	Symbol	Value	Unit	Test Conditions/Comments
Rated Dielectric Insulation Voltage		5000	V rms	1-minute duration
Minimum External Air Gap (Clearance)	L (I01)	8.3	mm min	Measured from input terminals to output terminals, shortest distance through air
Minimum External Tracking (Creepage)	L (I02)	8.3	mm min	Measured from input terminals to output terminals, shortest distance path along body
Minimum Clearance in the Plane of the Printed Circuit Board (PCB Clearance)	L (PCB)	8.3	mm min	Measured from input terminals to output terminals, shortest distance through air, line of sight, in the PCB mounting plane
Minimum Internal Gap (Internal Clearance)		25.5	µm min	Insulation distance through insulation
Tracking Resistance (Comparative Tracking Index)	CTI	>400	V	DIN IEC 112/VDE 0303 Part 1
Material Group		II		Material Group (DIN VDE 0110, 1/89, Table 1)

PACKAGE CHARACTERISTICS**Table 11.**

Parameter	Symbol	Min	Typ	Max	Unit	Test Conditions/Comments
Resistance (Input to Output) ¹	R _{I-O}		10 ¹³		Ω	
Capacitance (Input to Output) ¹	C _{I-O}		2.2		pF	f = 1 MHz
Input Capacitance ²	C _I		4.0		pF	
IC Junction to Ambient Thermal Resistance	θ _{JA}		45		°C/W	Thermocouple located at center of package underside

¹ The device is considered a 2-terminal device: Pin 1 through Pin 8 are shorted together, and Pin 9 through Pin 16 are shorted together.

² Input capacitance is from any input data pin to ground.

REGULATORY INFORMATION

See Table 17, Table 18, and the Insulation Lifetime section for details regarding recommended maximum working voltages for specific cross-isolation waveforms and insulation levels.

Table 12. RW-16 Wide Body [SOIC_W] Package

UL	CSA	VDE	CQC
Recognized Under UL 1577 Component Recognition Program ¹	Approved under CSA Component Acceptance Notice 5A	Certified according to DIN V VDE V 0884-10 (VDE V 0884-10):2006-12 ²	Certified by CQC11-471543-2012, GB4943.1-2011:
Single Protection, 5000 V rms Isolation Voltage	CSA 60950-1-07+A1+A2 and IEC 60950-1, second edition, +A1+A2:	Reinforced insulation, $V_{IORM} = 849$ peak, $V_{IOSM} = 8000$ V peak	Basic insulation at 760 V rms (1075 V peak)
Double Protection, 5000 V rms Isolation Voltage	Basic insulation at 780 V rms (1103 V peak)	Basic insulation, $V_{IORM} = 849$ V peak, $V_{IOSM} = 12$ kV peak	Reinforced insulation at 380 V rms (537 V peak), tropical climate, altitude ≤ 5000 meters
File E214100	Reinforced insulation at 390 V rms (552 V peak) IEC 60601-1 Edition 3.1: Basic insulation (1 means of patient protection (1 MOPP)), 490 V rms (686 V peak) Reinforced insulation (2 MOPP), 238 V rms (325 V peak) CSA 61010-1-12 and IEC 61010-1 third edition: Basic insulation at 300 V rms mains, 780 V secondary (1103 V peak) Reinforced insulation at 300 V rms mains, 390 V secondary (552 V peak) File 205078	File 2471900-4880-0001	File CQC16001147385

¹ In accordance with UL 1577, each product is proof tested by applying an insulation test voltage ≥ 6000 V rms for 1 sec.

² In accordance with DIN V VDE V 0884-10, each product is proof tested by applying an insulation test voltage ≥ 1592 V peak for 1 sec (partial discharge detection limit = 5 pC). The asterisk (*) branded on the component designates DIN V VDE V 0884-10 approval.

Table 13. RI-16 -2 Wide Body Increased Creepage [SOIC_IC] Package

UL	CSA	VDE	CQC
Recognized Under 1577 Component Recognition Program ¹	Approved under CSA Component Acceptance Notice 5A	Certified according to DIN V VDE V 0884-10 (VDE V 0884-10):2006-12 ²	Certified by CQC11-471543-2012, GB4943.1-2011
Single Protection, 5000 V rms Isolation Voltage	CSA 60950-1-07+A1+A2 and IEC 60950-1, second edition, +A1+A2:	Reinforced insulation, $V_{IORM} = 849$ peak, $V_{IOSM} = 8000$ V peak	Basic insulation at 820 V rms (1159 V peak)
Double Protection, 5000 V rms Isolation Voltage	Basic insulation at 830 V rms (1174 V peak)	Basic insulation, $V_{IORM} = 849$ V peak, $V_{IOSM} = 12$ kV peak	Reinforced insulation at 410 V rms (578 V peak), tropical climate, altitude ≤ 5000 meters
File E214100	Reinforced insulation at 415 V rms (587 V peak) IEC 60601-1 Edition 3.1: Basic insulation (1 means of patient protection (1 MOPP)), 519 V rms (734 V peak) Reinforced insulation (2 MOPP), 261 V rms (369 V peak) CSA 61010-1-12 and IEC 61010-1 third edition: Basic insulation at 300 V rms mains, 830 V secondary (1174 V peak) Reinforced insulation at 300 V rms Mains, 390 V secondary (587 V peak) File 205078	File 2471900-4880-0001	File CQC17001171586

¹ In accordance with UL 1577, each product is proof tested by applying an insulation test voltage ≥ 6000 V rms for 1 sec.

² In accordance with DIN V VDE V 0884-10, each product is proof tested by applying an insulation test voltage ≥ 1592 V peak for 1 sec (partial discharge detection limit = 5 pC). The asterisk (*) branded on the component designates DIN V VDE V 0884-10 approval.

DIN V VDE V 0884-10 (VDE V 0884-10) INSULATION CHARACTERISTICS

These isolators are suitable for reinforced electrical isolation only within the safety limit data. Protective circuits ensure the maintenance of the safety data. The asterisk (*) marking on packages denotes DIN V VDE V 0884-10 approval.

Table 14.

Description	Test Conditions/Comments	Symbol	Characteristic	Unit
Installation Classification per DIN VDE 0110 For Rated Mains Voltage ≤ 150 V rms For Rated Mains Voltage ≤ 300 V rms For Rated Mains Voltage ≤ 600 V rms			I to IV I to IV I to III	
Climatic Classification			40/125/21	
Pollution Degree per DIN VDE 0110, Table 1			2	
Maximum Working Insulation Voltage		V_{IORM}	849	V peak
Input to Output Test Voltage, Method B1	$V_{IORM} \times 1.875 = V_{pd(m)}$, 100% production test, $t_{ini} = t_m = 1$ sec, partial discharge < 5 pC	$V_{pd(m)}$	1592	V peak
Input to Output Test Voltage, Method A After Environmental Tests Subgroup 1	$V_{IORM} \times 1.5 = V_{pd(m)}$, $t_{ini} = 60$ sec, $t_m = 10$ sec, partial discharge < 5 pC	$V_{pd(m)}$	1274	V peak
After Input and/or Safety Test Subgroup 2 and Subgroup 3	$V_{IORM} \times 1.2 = V_{pd(m)}$, $t_{ini} = 60$ sec, $t_m = 10$ sec, partial discharge < 5 pC		1019	V peak
Highest Allowable Overvoltage		V_{IOTM}	7000	V peak
Surge Isolation Voltage Basic	$V_{PEAK} = 12.8$ kV, 1.2 μ s rise time, 50 μ s, 50% fall time	V_{IOSM}	12000	V peak
Surge Isolation Voltage Reinforced	$V_{PEAK} = 12.8$ kV, 1.2 μ s rise time, 50 μ s, 50% fall time	V_{IOSM}	8000	V peak
Safety Limiting Values	Maximum value allowed in the event of a failure (see Figure 4)			
Maximum Junction Temperature		T_S	150	$^{\circ}$ C
Total Power Dissipation at 25 $^{\circ}$ C		P_S	2.78	W
Insulation Resistance at T_S	$V_{IO} = 500$ V	R_S	$>10^9$	Ω

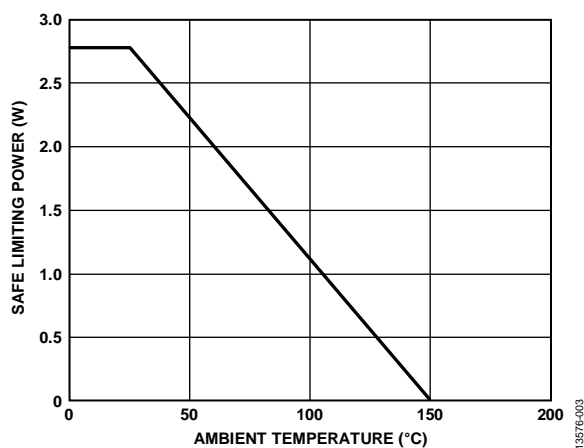

Figure 4. Thermal Derating Curve, Dependence of Safety Limiting Values with Ambient Temperature per DIN V VDE V 0884-10

RECOMMENDED OPERATING CONDITIONS**Table 15.**

Parameter	Symbol	Rating
Operating Temperature	T_A	-40° C to $+125^{\circ}$ C
Supply Voltages	V_{DD1}, V_{DD2}	1.7 V to 5.5 V
Input Signal Rise and Fall Times		1.0 ms

ABSOLUTE MAXIMUM RATINGS

T_A = 25°C, unless otherwise noted.

Table 16.

Parameter	Rating
Storage Temperature (T _{ST}) Range	−65°C to +150°C
Ambient Operating Temperature (T _A) Range	−40°C to +125°C
Supply Voltages (V _{DD1} , V _{DD2})	−0.5 V to +7.0 V
Input Voltages (V _{IA} , V _{IB} , V _{IC} , V _{ID} , V _{E1} , V _{E2} , DISABLE ₁ , DISABLE ₂) ¹	−0.5 V to V _{DD1} + 0.5 V
Output Voltages (V _{OA} , V _{OB} , V _{OC} , V _{OD}) ²	−0.5 V to V _{DD0} + 0.5 V
Average Output Current per Pin ³	
Side 1 Output Current (I _{O1})	−10 mA to +10 mA
Side 2 Output Current (I _{O2})	−10 mA to +10 mA
Common-Mode Transients ⁴	−150 kV/μs to +150 kV/μs

¹ V_{DD1} is the input side supply voltage.

² V_{DD0} is the output side supply voltage.

³ See Figure 4 for the maximum rated current values for various ambient temperatures.

⁴ Refers to the common-mode transients across the insulation barrier. Common-mode transients exceeding the absolute maximum ratings may cause latch-up or permanent damage.

Stresses at or above those listed under Absolute Maximum Ratings may cause permanent damage to the product. This is a stress rating only; functional operation of the product at these or any other conditions above those indicated in the operational section of this specification is not implied. Operation beyond the maximum operating conditions for extended periods may affect product reliability.

Table 17. Maximum Continuous Working Voltage¹ RW-16 Wide Body [SOIC_W] Package

Parameter	Rating	Constraint
AC Voltage		
Bipolar Waveform		
Basic Insulation	849 V peak	50-year minimum insulation lifetime
Reinforced Insulation	768 V peak	Lifetime limited by package creepage maximum approved working voltage per IEC 60950-1
Unipolar Waveform		
Basic Insulation	1698 V peak	50-year minimum insulation lifetime
Reinforced Insulation	885 V peak	Lifetime limited by package creepage maximum approved working voltage per IEC 60950-1
DC Voltage		
Basic Insulation	1092 V peak	Lifetime limited by package creepage maximum approved working voltage per IEC 60950-1
Reinforced Insulation	543 V peak	Lifetime limited by package creepage maximum approved working voltage per IEC 60950-1

¹ Refers to the continuous voltage magnitude imposed across the isolation barrier. See the Insulation Lifetime section for more details.

Table 18. Maximum Continuous Working Voltage¹ RI-16-2 Wide Body Increased Creepage [SOIC_IC] Package

Parameter	Rating	Constraint
AC Voltage		
Bipolar Waveform		
Basic Insulation	849 V peak	50-year minimum insulation lifetime
Reinforced Insulation	819 V peak	Lifetime limited by package creepage maximum approved working voltage per IEC 60950-1
Unipolar Waveform		
Basic Insulation	1698 V peak	50-year minimum insulation lifetime
Reinforced Insulation	943 V peak	Lifetime limited by package creepage maximum approved working voltage per IEC 60950-1
DC Voltage		
Basic Insulation	1157 V peak	Lifetime limited by package creepage maximum approved working voltage per IEC 60950-1
Reinforced Insulation	579 V peak	Lifetime limited by package creepage maximum approved working voltage per IEC 60950-1

¹ Refers to the continuous voltage magnitude imposed across the isolation barrier. See the Insulation Lifetime section for more details.

ESD CAUTION



ESD (electrostatic discharge) sensitive device.

Charged devices and circuit boards can discharge without detection. Although this product features patented or proprietary protection circuitry, damage may occur on devices subjected to high energy ESD. Therefore, proper ESD precautions should be taken to avoid performance degradation or loss of functionality.

Truth Tables**Table 19. ADuM240D/ADuM241D/ADuM242D Truth Table (Positive Logic)**

V_{ix} Input^{1,2}	V_{DISABLEx} Input^{1,2}	V_{DDI} State²	V_{DDO} State²	Default Low (D0), V_{Ox} Output^{1,2,3}	Default High (D1), V_{Ox} Output^{1,2,3}	Test Conditions/ Comments
L	L or NC	Powered	Powered	L	L	Normal operation
H	L or NC	Powered	Powered	H	H	Normal operation
X	H	Powered	Powered	L	H	Inputs disabled, fail-safe output
X ⁴	X ⁴	Unpowered	Powered	L	H	Fail-safe output
X ⁴	X ⁴	Powered	Unpowered	Indeterminate	Indeterminate	

¹ L means low, H means high, X means don't care, and NC means not connected.

² V_{ix} and V_{Ox} refer to the input and output signals of a given channel (A, B, C, or D). V_{DISABLEx} refers to the input disable signal on the same side as the V_{ix} inputs. V_{DDI} and V_{DDO} refer to the supply voltages on the input and output sides of the given channel, respectively.

³ D0 is the ADuM240D0/ADuM241D0/ADuM242D0 models, and D1 is the ADuM240D1/ADuM241D1/ADuM242D1 models. See the Ordering Guide section.

⁴ Input pins (V_{ix}, V_{DISABLEx}) on the same side as an unpowered supply must be in a low state to avoid powering the device through its ESD protection circuitry.

Table 20. ADuM240E/ADuM241E/ADuM242E Truth Table (Positive Logic)

V_{ix} Input^{1,2}	V_{Ex} Input^{1,2}	V_{DDI} State²	V_{DDO} State²	Default Low (E0), V_{Ox} Output^{1,2,3}	Default High (E1), V_{Ox} Output^{1,2,3}	Test Conditions/ Comments
L	H or NC	Powered	Powered	L	L	Normal operation
H	H or NC	Powered	Powered	H	H	Normal operation
X	L	Powered	Powered	Z	Z	Outputs disabled
L	H or NC	Unpowered	Powered	L	H	Fail-safe output
X ⁴	L ⁴	Unpowered	Powered	Z	Z	Outputs disabled
X ⁴	X ⁴	Powered	Unpowered	Indeterminate	Indeterminate	

¹ L means low, H means high, X means don't care, NC means not connected, and Z means high impedance.

² V_{ix} and V_{Ox} refer to the input and output signals of a given channel (A, B, C, or D). V_{Ex} refers to the output enable signal on the same side as the V_{Ox} outputs. V_{DDI} and V_{DDO} refer to the supply voltages on the input and output sides of the given channel, respectively.

³ E0 is the ADuM240E0/ADuM241E0/ADuM242E0 models, and E1 is the ADuM240E1/ADuM241E1/ADuM242E1 models. See the Ordering Guide section.

⁴ Input pins (V_{ix}, V_{Ex}) on the same side as an unpowered supply must be in a low state to avoid powering the device through its ESD protection circuitry.

PIN CONFIGURATIONS AND FUNCTION DESCRIPTIONS

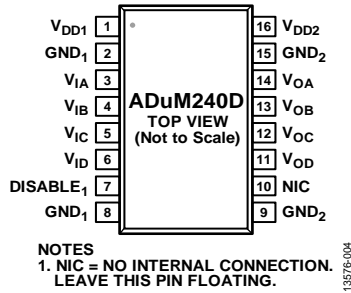

Figure 5. ADuM240D Pin Configuration

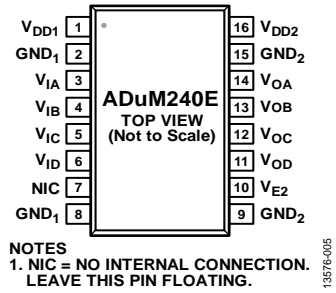

Figure 6. ADuM240E Pin Configuration

Table 21. Pin Function Descriptions

Pin No. ¹		Mnemonic	Description
ADuM240D	ADuM240E		
1	1	V _{DD1}	Supply Voltage for Isolator Side 1.
2, 8	2, 8	GND ₁	Ground Reference for Isolator Side 1.
3	3	V _{IA}	Logic Input A.
4	4	V _{IB}	Logic Input B.
5	5	V _{IC}	Logic Input C.
6	6	V _{ID}	Logic Input D.
7	Not applicable	DISABLE ₁	Input Disable 1. This pin disables the isolator inputs. Outputs take on the logic state determined by the fail-safe option shown in the Ordering Guide.
9, 15	9, 15	GND ₂	Ground Reference for Isolator Side 2.
10	7	NIC	No Internal Connection. Leave this pin floating.
Not Applicable	10	V _{E2}	Output Enable 2. Active high logic input. When V _{E2} is high or disconnected, the V _{OA} , V _{OB} , V _{OC} , and V _{OD} outputs are enabled. When V _{E2} is low, the V _{OA} , V _{OB} , V _{OC} , and V _{OD} outputs are disabled to the high-Z state.
11	11	V _{OD}	Logic Output D.
12	12	V _{OC}	Logic Output C.
13	13	V _{OB}	Logic Output B.
14	14	V _{OA}	Logic Output A.
16	16	V _{DD2}	Supply Voltage for Isolator Side 2.

¹ Reference the [AN-1109 Application Note](#) for specific layout guidelines.

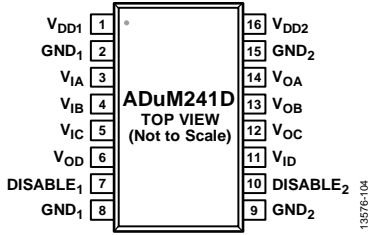

Figure 7. ADuM241D Pin Configuration

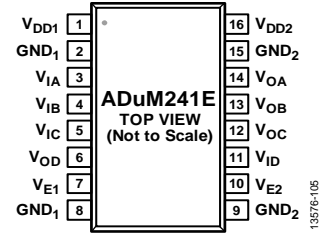

Figure 8. ADuM241E Pin Configuration

Table 22. Pin Function Descriptions

Pin No. ¹		Mnemonic	Description
ADuM241D	ADuM241E		
1	1	VDD1	Supply Voltage for Isolator Side 1.
2, 8	2, 8	GND1	Ground Reference for Isolator Side 1.
3	3	VIA	Logic Input A.
4	4	VIB	Logic Input B.
5	5	VIC	Logic Input C.
6	6	VOD	Logic Output D.
7	Not applicable	DISABLE1	Input Disable 1. This pin disables the isolator inputs. Outputs take on the logic state determined by the fail-safe option shown in the Ordering Guide.
Not Applicable	7	VE1	Output Enable 1. Active high logic input. When VE1 is high or disconnected, the VOD output is enabled. When VE1 is low, the VOD output is disabled to the high-Z state.
9, 15	9, 15	GND2	Ground Reference for Isolator Side 2.
10	Not applicable	DISABLE2	Input Disable 2. This pin disables the isolator inputs. Outputs take on the logic state determined by the fail-safe option shown in the Ordering Guide.
Not Applicable	10	VE2	Output Enable 2. Active high logic input. When VE2 is high or disconnected, the VOA, VOB, and VOC outputs are enabled. When VE2 is low, the VOA, VOB, and VOC outputs are disabled to the high-Z state.
11	11	VID	Logic Input D.
12	12	VOC	Logic Output C.
13	13	VOB	Logic Output B.
14	14	VOA	Logic Output A.
16	16	VDD2	Supply Voltage for Isolator Side 2.

¹ Reference the [AN-1109 Application Note](#) for specific layout guidelines.



Figure 9. ADuM242D Pin Configuration



Figure 10. ADuM242E Pin Configuration

Table 23. Pin Function Descriptions

Pin No. ¹		Mnemonic	Description
ADuM242D	ADuM242E		
1	1	V _{DD1}	Supply Voltage for Isolator Side 1.
2, 8	2, 8	GND ₁	Ground Reference for Isolator Side 1.
3	3	V _{IA}	Logic Input A.
4	4	V _{IB}	Logic Input B.
5	5	V _{OC}	Logic Output C.
6	6	V _{OD}	Logic Output D.
7	Not applicable	DISABLE ₁	Input Disable 1. This pin disables the isolator inputs. Outputs take on the logic state determined by the fail-safe option shown in the Ordering Guide.
Not Applicable	7	V _{E1}	Output Enable 1. Active high logic input. When V _{E1} is high or disconnected, the V _{OC} and V _{OD} outputs are enabled. When V _{E1} is low, the V _{OC} and V _{OD} outputs are disabled to the high-Z state.
9, 15	9, 15	GND ₂	Ground Reference for Isolator Side 2.
10	Not applicable	DISABLE ₂	Input Disable 2. This pin disables the isolator inputs. Outputs take on the logic state determined by the fail-safe option shown in the Ordering Guide.
Not Applicable	10	V _{E2}	Output Enable 2. Active high logic input. When V _{E2} is high or disconnected, the V _{OA} and V _{OB} outputs are enabled. When V _{E2} is low, the V _{OA} and V _{OB} outputs are disabled to the high-Z state.
11	11	V _{ID}	Logic Input D.
12	12	V _{IC}	Logic Input C.
13	13	V _{OB}	Logic Output B.
14	14	V _{OA}	Logic Output A.
16	16	V _{DD2}	Supply Voltage for Isolator Side 2.

¹ Reference the [AN-1109 Application Note](#) for specific layout guidelines.

TYPICAL PERFORMANCE CHARACTERISTICS



Figure 11. ADuM240D/ADuM240E I_{DD1} Supply Current vs. Data Rate at Various Voltages



Figure 14. ADuM241D/ADuM241E I_{DD2} Supply Current vs. Data Rate at Various Voltages



Figure 12. ADuM240D/ADuM240E I_{DD2} Supply Current vs. Data Rate at Various Voltages



Figure 15. ADuM242D/ADuM242E I_{DD1} Supply Current vs. Data Rate at Various Voltages



Figure 13. ADuM241D/ADuM241E I_{DD1} Supply Current vs. Data Rate at Various Voltages



Figure 16. ADuM242D/ADuM242E I_{DD2} Supply Current vs. Data Rate at Various Voltages



Figure 17. Propagation Delay, t_{PLH} vs. Temperature at Various Voltages



Figure 18. Propagation Delay, t_{PHL} vs. Temperature at Various Voltages

THEORY OF OPERATION

The ADuM240D/ADuM240E/ADuM241D/ADuM241E/ADuM242D/ADuM242E use a high frequency carrier to transmit data across the isolation barrier using *i*Coupler chip scale transformer coils separated by layers of polyimide isolation. Using an on/off keying (OOK) technique and the differential architecture shown in Figure 19 and Figure 20, the ADuM240D/ADuM240E/ADuM241D/ADuM241E/ADuM242D/ADuM242E have very low propagation delay and high speed. Internal regulators and input/output design techniques allow logic and supply voltages over a wide range from 1.7 V to 5.5 V, offering voltage translation of 1.8 V, 2.5 V, 3.3 V, and 5 V logic. The architecture is designed for high common-mode transient immunity and high immunity to electrical noise and magnetic interference. Radiated emissions are minimized with a spread spectrum OOK carrier and other techniques.

Figure 19 illustrates the waveforms for models of the ADuM240D/ADuM240E/ADuM241D/ADuM241E/ADuM242D/ADuM242E that have the condition of the fail-safe output state equal to low, where the carrier waveform is off when the input state is low. If the input side is off or not operating, the low fail-safe output state (ADuM240D0/ADuM240E0/ADuM241D0/ADuM241E0/ADuM242D0/ADuM242E0) sets the output to low. For the ADuM240D/ADuM240E/ADuM241D/ADuM241E/ADuM242D/ADuM242E that have a high fail-safe output state, Figure 20 illustrates the conditions where the carrier waveform is off when the input state is high. When the input side is off or not operating, the high fail-safe output state (ADuM240D1/ADuM240E1/ADuM241D1/ADuM241E1/ADuM242D1/ADuM242E1) sets the output to high. See the Ordering Guide for the model numbers that have the fail-safe output state of low or the fail-safe output state of high.



Figure 19. Operational Block Diagram of a Single Channel with a Low Fail-Safe Output State



Figure 20. Operational Block Diagram of a Single Channel with a High Fail-Safe Output State

APPLICATIONS INFORMATION

PCB LAYOUT

The ADuM240D/ADuM240E/ADuM241D/ADuM241E/ADuM242D/ADuM242E digital isolators require no external interface circuitry for the logic interfaces. Power supply bypassing is strongly recommended at the input and output supply pins (see Figure 21). Bypass capacitors are most conveniently connected between Pin 1 and Pin 2 for V_{DD1} and between Pin 15 and Pin 16 for V_{DD2} . The recommended bypass capacitor value is between 0.01 μF and 0.1 μF . The total lead length between both ends of the capacitor and the input power supply pin must not exceed 10 mm. Bypassing between Pin 1 and Pin 8 and between Pin 9 and Pin 16 must also be considered, unless the ground pair on each package side is connected close to the package.

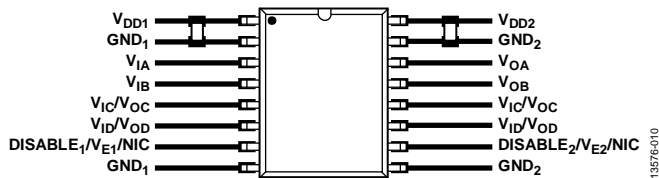

Figure 21. Recommended Printed Circuit Board Layout

In applications involving high common-mode transients, ensure that board coupling across the isolation barrier is minimized. Furthermore, design the board layout such that any coupling that does occur equally affects all pins on a given component side. Failure to ensure this can cause voltage differentials between pins exceeding the Absolute Maximum Ratings of the device, thereby leading to latch-up or permanent damage.

See the AN-1109 Application Note for board layout guidelines.

PROPAGATION DELAY RELATED PARAMETERS

Propagation delay is a parameter that describes the time required for a logic signal to propagate through a component. The propagation delay to a Logic 0 output may differ from the propagation delay to a Logic 1 output.

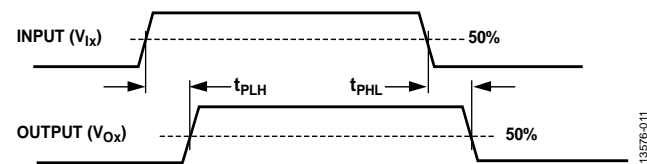

Figure 22. Propagation Delay Parameters

Pulse width distortion is the maximum difference between these two propagation delay values and is an indication of how accurately the timing of the input signal is preserved.

Channel matching is the maximum amount the propagation delay differs between channels within a single ADuM240D/ADuM240E/ADuM241D/ADuM241E/ADuM242D/ADuM242E component.

Propagation delay skew is the maximum amount the propagation delay differs between multiple ADuM240D/ADuM240E/ADuM241D/ADuM241E/ADuM242D/ADuM242E components operating under the same conditions

JITTER MEASUREMENT

Figure 23 shows the eye diagram for the ADuM240D/ADuM240E/ADuM241D/ADuM241E/ADuM242D/ADuM242E. The measurement was taken using an Agilent 81110A pulse pattern generator at 150 Mbps with pseudorandom bit sequences (PRBS) $2(n-1)$, $n=14$, for 5 V supplies. Jitter was measured with the Tektronix Model 5104B oscilloscope, 1 GHz, 10 GSps with the DPOJET jitter and eye diagram analysis tools. The result shows a typical measurement on the ADuM240D/ADuM240E/ADuM241D/ADuM241E/ADuM242D/ADuM242E with 490 ps p-p jitter.

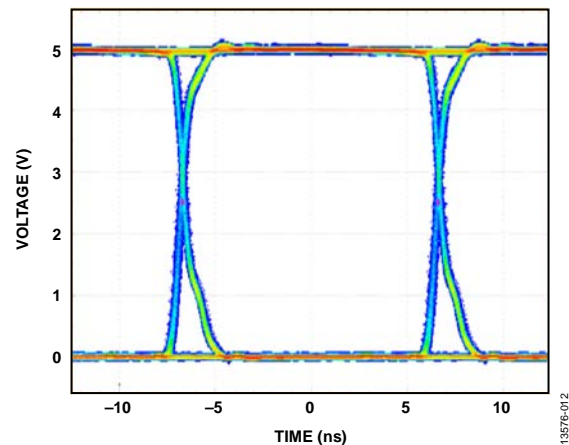

Figure 23. ADuM240D/ADuM240E/ADuM241D/ADuM241E/ADuM242D/ADuM242E Eye Diagram

INSULATION LIFETIME

All insulation structures eventually break down when subjected to voltage stress over a sufficiently long period. The rate of insulation degradation is dependent on the characteristics of the voltage waveform applied across the insulation as well as on the materials and material interfaces.

The two types of insulation degradation of primary interest are breakdown along surfaces exposed to the air and insulation wear out. Surface breakdown is the phenomenon of surface tracking, and the primary determinant of surface creepage requirements in system level standards. Insulation wear out is the phenomenon where charge injection or displacement currents inside the insulation material cause long-term insulation degradation.

Surface Tracking

Surface tracking is addressed in electrical safety standards by setting a minimum surface creepage based on the working voltage, the environmental conditions, and the properties of the insulation material. Safety agencies perform characterization testing on the surface insulation of components that allows the components to be categorized in different material groups. Lower material group ratings are more resistant to surface tracking and, therefore, can provide adequate lifetime with smaller creepage. The minimum creepage for a given working voltage and material group is in each

system level standard and is based on the total rms voltage across the isolation, pollution degree, and material group. The material group and creepage for the [ADuM240D/ADuM240E/ADuM241D/ADuM241E/ADuM242D/ADuM242E](#) isolators are presented in Table 9.

Insulation Wear Out

The lifetime of insulation caused by wear out is determined by its thickness, material properties, and the voltage stress applied. It is important to verify that the product lifetime is adequate at the application working voltage. The working voltage supported by an isolator for wear out may not be the same as the working voltage supported for tracking. The working voltage applicable to tracking is specified in most standards.

Testing and modeling have shown that the primary driver of long-term degradation is displacement current in the polyimide insulation causing incremental damage. The stress on the insulation can be broken down into broad categories, such as dc stress, which causes very little wear out because there is no displacement current, and an ac component time varying voltage stress, which causes wear out.

The ratings in certification documents are usually based on 60 Hz sinusoidal stress because this reflects isolation from line voltage. However, many practical applications have combinations of 60 Hz ac and dc across the barrier as shown in Equation 1. Because only the ac portion of the stress causes wear out, the equation can be rearranged to solve for the ac rms voltage, as is shown in Equation 2. For insulation wear out with the polyimide materials used in these products, the ac rms voltage determines the product lifetime.

$$V_{RMS} = \sqrt{V_{AC\ RMS}^2 + V_{DC}^2} \quad (1)$$

or

$$V_{AC\ RMS} = \sqrt{V_{RMS}^2 - V_{DC}^2} \quad (2)$$

where:

V_{RMS} is the total rms working voltage.

$V_{AC\ RMS}$ is the time varying portion of the working voltage.

V_{DC} is the dc offset of the working voltage.

Calculation and Use of Parameters Example

The following example frequently arises in power conversion applications. Assume that the line voltage on one side of the isolation is 240 V ac rms and a 400 V dc bus voltage is present on the other side of the isolation barrier. The isolator material is polyimide. To establish the critical voltages in determining the creepage, clearance, and lifetime of a device, see Figure 24 and the following equations.



Figure 24. Critical Voltage Example

The working voltage across the barrier from Equation 1 is

$$V_{RMS} = \sqrt{V_{AC\ RMS}^2 + V_{DC}^2}$$

$$V_{RMS} = \sqrt{240^2 + 400^2}$$

$$V_{RMS} = 466\text{ V}$$

This V_{RMS} value is the working voltage used together with the material group and pollution degree when looking up the creepage required by a system standard.

To determine if the lifetime is adequate, obtain the time varying portion of the working voltage. To obtain the ac rms voltage, use Equation 2.

$$V_{AC\ RMS} = \sqrt{V_{RMS}^2 - V_{DC}^2}$$

$$V_{AC\ RMS} = \sqrt{466^2 - 400^2}$$

$$V_{AC\ RMS} = 240\text{ V rms}$$

In this case, the ac rms voltage is simply the line voltage of 240 V rms. This calculation is more relevant when the waveform is not sinusoidal. The value is compared to the limits for working voltage in Table 17 for the expected lifetime, less than a 60 Hz sine wave, and it is well within the limit for a 50-year service life.

Note that the dc working voltage limit in Table 17 is set by the creepage of the package as specified in IEC 60664-1. This value can differ for specific system level standards.

OUTLINE DIMENSIONS

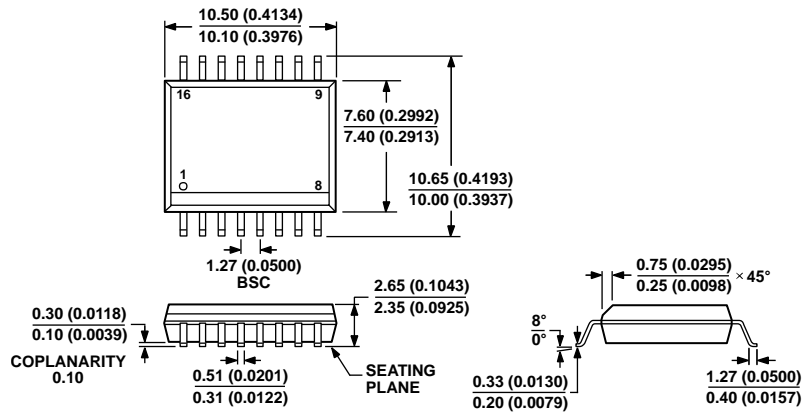

COMPLIANT TO JEDEC STANDARDS MS-013-AA
 CONTROLLING DIMENSIONS ARE IN MILLIMETERS; INCH DIMENSIONS
 (IN PARENTHESES) ARE ROUNDED-OFF MILLIMETER EQUIVALENTS FOR
 REFERENCE ONLY AND ARE NOT APPROPRIATE FOR USE IN DESIGN.

Figure 25. 16-Lead Standard Small Outline Package [SOIC_W]
 Wide Body
 (RW-16)

Dimensions shown in millimeters and (inches)

03-27-2007-9

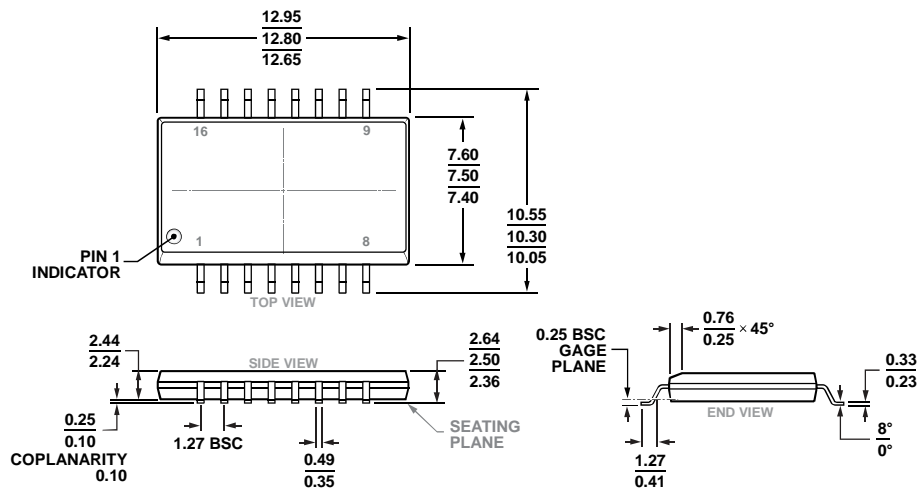

COMPLIANT TO JEDEC STANDARDS MS-013-AC

Figure 26. 16-Lead Standard Small Outline Package, with Increased Creepage [SOIC_IC]
 Wide Body
 (RI-16-2)

Dimensions shown in millimeters

12-13-2017-B

ORDERING GUIDE

Model ^{1,2}	Temperature Range	No. of Inputs, V _{DD1} Side	No. of Inputs, V _{DD2} Side	Withstand Voltage Rating (kV rms)	Fail-Safe Output State	Input Disable	Output Enable	Package Description	Package Option
ADuM240D1BRWZ	-40°C to +125°C	4	0	5.0	High	Yes	No	16-Lead SOIC_W	RW-16
ADuM240D1BRWZ-RL	-40°C to +125°C	4	0	5.0	High	Yes	No	16-Lead SOIC_W	RW-16
ADuM240D0BRWZ	-40°C to +125°C	4	0	5.0	Low	Yes	No	16-Lead SOIC_W	RW-16
ADuM240D0BRWZ-RL	-40°C to +125°C	4	0	5.0	Low	Yes	No	16-Lead SOIC_W	RW-16
ADuM240E1BRWZ	-40°C to +125°C	4	0	5.0	High	No	Yes	16-Lead SOIC_W	RW-16
ADuM240E1BRWZ-RL	-40°C to +125°C	4	0	5.0	High	No	Yes	16-Lead SOIC_W	RW-16
ADuM240E0BRWZ	-40°C to +125°C	4	0	5.0	Low	No	Yes	16-Lead SOIC_W	RW-16
ADuM240E0BRWZ-RL	-40°C to +125°C	4	0	5.0	Low	No	Yes	16-Lead SOIC_W	RW-16

Model ^{1,2}	Temperature Range	No. of Inputs, V _{DD1} Side	No. of Inputs, V _{DD2} Side	Withstand Voltage Rating (kV rms)	Fail-Safe Output State	Input Disable	Output Enable	Package Description	Package Option
ADuM240E0WBRWZ	-40°C to +125°C	4	0	5.0	Low	No	Yes	16-Lead SOIC_W	RW-16
ADuM240E0WBRWZ-RL	-40°C to +125°C	4	0	5.0	Low	No	Yes	16-Lead SOIC_W	RW-16
ADuM240D1BRIZ	-40°C to +125°C	4	0	5.0	High	Yes	No	16-Lead SOIC_IC	RI-16-2
ADuM240D1BRIZ-RL	-40°C to +125°C	4	0	5.0	High	Yes	No	16-Lead SOIC_IC	RI-16-2
ADuM240D0BRIZ	-40°C to +125°C	4	0	5.0	Low	Yes	No	16-Lead SOIC_IC	RI-16-2
ADuM240D0BRIZ-RL	-40°C to +125°C	4	0	5.0	Low	Yes	No	16-Lead SOIC_IC	RI-16-2
ADuM240E1BRIZ	-40°C to +125°C	4	0	5.0	High	No	Yes	16-Lead SOIC_IC	RI-16-2
ADuM240E1BRIZ-RL	-40°C to +125°C	4	0	5.0	High	No	Yes	16-Lead SOIC_IC	RI-16-2
ADuM240E0BRIZ	-40°C to +125°C	4	0	5.0	Low	No	Yes	16-Lead SOIC_IC	RI-16-2
ADuM240E0BRIZ-RL	-40°C to +125°C	4	0	5.0	Low	No	Yes	16-Lead SOIC_IC	RI-16-2
ADuM241D1BRWZ	-40°C to +125°C	3	1	5.0	High	Yes	No	16-Lead SOIC_W	RW-16
ADuM241D1BRWZ-RL	-40°C to +125°C	3	1	5.0	High	Yes	No	16-Lead SOIC_W	RW-16
ADuM241D0BRWZ	-40°C to +125°C	3	1	5.0	Low	Yes	No	16-Lead SOIC_W	RW-16
ADuM241D0BRWZ-RL	-40°C to +125°C	3	1	5.0	Low	Yes	No	16-Lead SOIC_W	RW-16
ADuM241E1BRWZ	-40°C to +125°C	3	1	5.0	High	No	Yes	16-Lead SOIC_W	RW-16
ADuM241E1BRWZ-RL	-40°C to +125°C	3	1	5.0	High	No	Yes	16-Lead SOIC_W	RW-16
ADuM241E1WBRWZ	-40°C to +125°C	3	1	5.0	High	No	Yes	16-Lead SOIC_W	RW-16
ADuM241E1WBRWZ-RL	-40°C to +125°C	3	1	5.0	High	No	Yes	16-Lead SOIC_W	RW-16
ADuM241E0BRWZ	-40°C to +125°C	3	1	5.0	Low	No	Yes	16-Lead SOIC_W	RW-16
ADuM241E0BRWZ-RL	-40°C to +125°C	3	1	5.0	Low	No	Yes	16-Lead SOIC_W	RW-16
ADuM241D1BRIZ	-40°C to +125°C	3	1	5.0	High	Yes	No	16-Lead SOIC_IC	RI-16-2
ADuM241D1BRIZ-RL	-40°C to +125°C	3	1	5.0	High	Yes	No	16-Lead SOIC_IC	RI-16-2
ADuM241D0BRIZ	-40°C to +125°C	3	1	5.0	Low	Yes	No	16-Lead SOIC_IC	RI-16-2
ADuM241D0BRIZ-RL	-40°C to +125°C	3	1	5.0	Low	Yes	No	16-Lead SOIC_IC	RI-16-2
ADuM241E1BRIZ	-40°C to +125°C	3	1	5.0	High	No	Yes	16-Lead SOIC_IC	RI-16-2
ADuM241E1BRIZ-RL	-40°C to +125°C	3	1	5.0	High	No	Yes	16-Lead SOIC_IC	RI-16-2
ADuM241E0BRIZ	-40°C to +125°C	3	1	5.0	Low	No	Yes	16-Lead SOIC_IC	RI-16-2
ADuM241E0BRIZ-RL	-40°C to +125°C	3	1	5.0	Low	No	Yes	16-Lead SOIC_IC	RI-16-2
ADuM242D1BRWZ	-40°C to +125°C	2	2	5.0	High	Yes	No	16-Lead SOIC_W	RW-16
ADuM242D1BRWZ-RL	-40°C to +125°C	2	2	5.0	High	Yes	No	16-Lead SOIC_W	RW-16
ADuM242D0BRWZ	-40°C to +125°C	2	2	5.0	Low	Yes	No	16-Lead SOIC_W	RW-16
ADuM242D0BRWZ-RL	-40°C to +125°C	2	2	5.0	Low	Yes	No	16-Lead SOIC_W	RW-16
ADuM242E1BRWZ	-40°C to +125°C	2	2	5.0	High	No	Yes	16-Lead SOIC_W	RW-16
ADuM242E1BRWZ-RL	-40°C to +125°C	2	2	5.0	High	No	Yes	16-Lead SOIC_W	RW-16
ADuM242E0BRWZ	-40°C to +125°C	2	2	5.0	Low	No	Yes	16-Lead SOIC_W	RW-16
ADuM242E0BRWZ-RL	-40°C to +125°C	2	2	5.0	Low	No	Yes	16-Lead SOIC_W	RW-16
ADuM242E0WBRWZ	-40°C to +125°C	2	2	5.0	Low	No	Yes	16-Lead SOIC_W	RW-16
ADuM242E0WBRWZ-RL	-40°C to +125°C	2	2	5.0	Low	No	Yes	16-Lead SOIC_W	RW-16
ADuM242D1BRIZ	-40°C to +125°C	2	2	5.0	High	Yes	No	16-Lead SOIC_IC	RI-16-2
ADuM242D1BRIZ-RL	-40°C to +125°C	2	2	5.0	High	Yes	No	16-Lead SOIC_IC	RI-16-2
ADuM242D0BRIZ	-40°C to +125°C	2	2	5.0	Low	Yes	No	16-Lead SOIC_IC	RI-16-2
ADuM242D0BRIZ-RL	-40°C to +125°C	2	2	5.0	Low	Yes	No	16-Lead SOIC_IC	RI-16-2
ADuM242E1BRIZ	-40°C to +125°C	2	2	5.0	High	No	Yes	16-Lead SOIC_IC	RI-16-2
ADuM242E1BRIZ-RL	-40°C to +125°C	2	2	5.0	High	No	Yes	16-Lead SOIC_IC	RI-16-2
ADuM242E0BRIZ	-40°C to +125°C	2	2	5.0	Low	No	Yes	16-Lead SOIC_IC	RI-16-2
ADuM242E0BRIZ-RL	-40°C to +125°C	2	2	5.0	Low	No	Yes	16-Lead SOIC_IC	RI-16-2

¹ Z = RoHS Compliant Part.² The ADuM240E0WBRWZ, ADuM240E0WBRWZ-RL, ADuM241E1WBRWZ, ADuM241E1WBRWZ-RL, ADuM242E0WBRWZ and ADuM242E0WBRWZ-RL are qualified for automotive applications.

AUTOMOTIVE PRODUCTS

The [ADuM240E0W](#), [ADuM241E1W](#), and [ADuM242E0W](#) models are available with controlled manufacturing to support the quality and reliability requirements of automotive applications. Note that these automotive models may have specifications that differ from the commercial models; therefore, designers should review the Specifications section of this data sheet carefully. Only the automotive grade products shown are available for use in automotive applications. Contact your local Analog Devices account representative for specific product ordering information and to obtain the specific Automotive Reliability reports for these models.

Данный компонент на территории Российской Федерации

Вы можете приобрести в компании MosChip.

Для оперативного оформления запроса Вам необходимо перейти по данной ссылке:

<http://moschip.ru/get-element>

Вы можете разместить у нас заказ для любого Вашего проекта, будь то серийное производство или разработка единичного прибора.

В нашем ассортименте представлены ведущие мировые производители активных и пассивных электронных компонентов.

Нашей специализацией является поставка электронной компонентной базы двойного назначения, продукции таких производителей как XILINX, Intel (ex.ALTERA), Vicor, Microchip, Texas Instruments, Analog Devices, Mini-Circuits, Amphenol, Glenair.

Сотрудничество с глобальными дистрибьюторами электронных компонентов, предоставляет возможность заказывать и получать с международных складов практически любой перечень компонентов в оптимальные для Вас сроки.

На всех этапах разработки и производства наши партнеры могут получить квалифицированную поддержку опытных инженеров.

Система менеджмента качества компании отвечает требованиям в соответствии с ГОСТ Р ИСО 9001, ГОСТ РВ 0015-002 и ЭС РД 009

Офис по работе с юридическими лицами:

105318, г.Москва, ул.Щербаковская д.3, офис 1107, 1118, ДЦ «Щербаковский»

Телефон: +7 495 668-12-70 (многоканальный)

Факс: +7 495 668-12-70 (доб.304)

E-mail: info@moschip.ru

Skype отдела продаж:

moschip.ru

moschip.ru_4

moschip.ru_6

moschip.ru_9