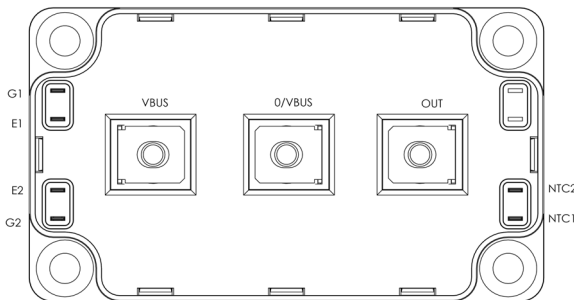
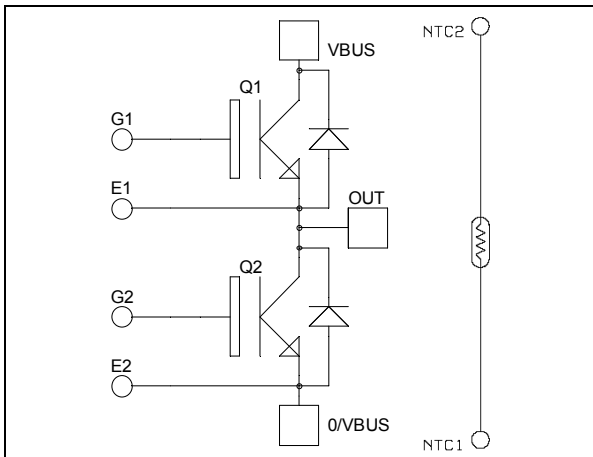

Phase leg
High speed Trench + Field Stop IGBT4
Power module

$V_{CES} = 650V$
 $I_C = 600A^* @ T_c = 60^\circ C$

Application

- Welding converters
- Switched Mode Power Supplies
- Uninterruptible Power Supplies
- Motor control

Features

- High speed Trench + Field Stop IGBT 4 Technology
 - Low voltage drop
 - Low leakage current
 - Low switching losses
 - Soft recovery parallel diodes
 - Low diode VF
 - RBSOA and SCSOA rated
- Kelvin source for easy drive
- Very low stray inductance
- M5 power connectors
- High level of integration
- Internal thermistor for temperature monitoring

Benefits

- Stable temperature behavior
- Very rugged
- Direct mounting to heatsink (isolated package)
- Low junction to case thermal resistance
- Easy paralleling due to positive TC of VCEsat
- Low profile
- RoHS Compliant

All ratings @ $T_j = 25^\circ C$ unless otherwise specified

Absolute maximum ratings (per IGBT)

| Symbol | Parameter | Max ratings | Unit |
|-----------|----------------------------------|---------------------|--------------|
| V_{CES} | Collector - Emitter Voltage | 650 | V |
| I_C | Continuous Collector Current | $T_C = 25^\circ C$ | 770* |
| | | $T_C = 60^\circ C$ | 600* |
| I_{CM} | Pulsed Collector Current | $T_C = 25^\circ C$ | 1500 |
| V_{GE} | Gate - Emitter Voltage | ± 20 | V |
| P_D | Maximum Power Dissipation | $T_C = 25^\circ C$ | 2000 |
| RBSOA | Reverse Bias Safe Operating Area | $T_j = 125^\circ C$ | 1200A @ 600V |

* Specification of device but current must be limited due to size of power connectors.

CAUTION: These Devices are sensitive to Electrostatic Discharge. Proper Handling Procedures Should Be Followed. See application note APT0502 on www.microsemi.com

Electrical Characteristics (per IGBT)

| Symbol | Characteristic | Test Conditions | Min | Typ | Max | Unit |
|---------------|--------------------------------------|---------------------------------|-----|-------------|-----|---------|
| I_{CES} | Zero Gate Voltage Collector Current | $V_{GE} = 0V, V_{CE} = 650V$ | | | 600 | μA |
| $V_{CE(sat)}$ | Collector Emitter saturation Voltage | $V_{GE} = 15V$ $I_C = 600A$ | | 1.85 2.2 | 2.3 | V |
| $V_{GE(th)}$ | Gate Threshold Voltage | $V_{GE} = V_{CE}, I_C = 3.2 mA$ | 4.2 | 5.1 | 5.6 | V |
| I_{GES} | Gate – Emitter Leakage Current | $V_{GE} = 20V, V_{CE} = 0V$ | | | 1 | μA |

Dynamic Characteristics (per IGBT)

| Symbol | Characteristic | Test Conditions | Min | Typ | Max | Unit |
|--------------|-------------------------------------|---|---|------------|-------|--------------|
| C_{ies} | Input Capacitance | $V_{GE} = 0V$ | | 36.6 | | nF |
| C_{oes} | Output Capacitance | $V_{CE} = 25V$ | | 1.3 | | |
| C_{res} | Reverse Transfer Capacitance | $f = 1MHz$ | | 1.08 | | |
| Q_G | Gate charge | $V_{GE} = 15V ; V_{CE} = 480V$ $I_C = 600A$ | | 3500 | | nC |
| $T_{d(on)}$ | Turn-on Delay Time | Inductive Switching (25°C) $V_{GE} = \pm 15V$ $V_{CE} = 400V$ $I_C = 600A$ $R_G = 0.6\Omega$ | | 19 | | ns |
| T_r | Rise Time | | | 33 | | |
| $T_{d(off)}$ | Turn-off Delay Time | | | 197 | | |
| T_f | Fall Time | | | 21 | | |
| $T_{d(on)}$ | Turn-on Delay Time | Inductive Switching (150°C) $V_{GE} = \pm 15V$ $V_{CE} = 400V$ $I_C = 600A$ $R_G = 0.6\Omega$ | | 19 | | ns |
| T_r | Rise Time | | | 29 | | |
| $T_{d(off)}$ | Turn-off Delay Time | | | 227 | | |
| T_f | Fall Time | | | 22 | | |
| E_{on} | Turn-on Switching Energy | $V_{GE} = \pm 15V$ $V_{CE} = 400V$ $I_C = 600A$ | $T_j = 25^\circ C$ $T_j = 150^\circ C$ | 12 14.7 | | mJ |
| E_{off} | Turn-off Switching Energy | $R_G = 0.6\Omega$ | $T_j = 25^\circ C$ $T_j = 150^\circ C$ | 11.2 12 | | mJ |
| I_{sc} | Short Circuit data | $V_{GE} \leq 15V ; V_{Bus} = 600V$ $t_p \leq 10\mu s ; T_j = 150^\circ C$ | | 3900 | | A |
| R_{thJC} | Junction to Case Thermal Resistance | | | | 0.075 | $^\circ C/W$ |

Diode ratings and characteristics (per diode)

| Symbol | Characteristic | Test Conditions | Min | Typ | Max | Unit |
|------------|-------------------------------------|---|---------------------|------|------|--------------|
| V_{RRM} | Repetitive Reverse Voltage | | | | 650 | V |
| I_{RM} | Reverse Leakage Current | $V_R = 650V$ | | | 300 | μA |
| I_F | DC Forward Current | | | 600 | | A |
| V_F | Diode Forward Voltage | $I_F = 600A$ $V_{GE} = 0V$ | $T_j = 25^\circ C$ | 1.6 | 2 | V |
| | | | $T_j = 150^\circ C$ | 1.5 | | |
| t_{rr} | Reverse Recovery Time | $I_F = 600A$ $V_R = 400V$ $di/dt = 7000A/\mu s$ | $T_j = 25^\circ C$ | 125 | | ns |
| | | | $T_j = 150^\circ C$ | 220 | | |
| Q_{rr} | Reverse Recovery Charge | $I_F = 600A$ $V_R = 400V$ $di/dt = 7000A/\mu s$ | $T_j = 25^\circ C$ | 28.1 | | μC |
| | | | $T_j = 150^\circ C$ | 59.3 | | |
| E_r | Reverse Recovery Energy | $I_F = 600A$ $V_R = 400V$ $di/dt = 7000A/\mu s$ | $T_j = 25^\circ C$ | 6.6 | | mJ |
| | | | $T_j = 150^\circ C$ | 14.4 | | |
| R_{thJC} | Junction to Case Thermal Resistance | | | | 0.13 | $^\circ C/W$ |

Temperature sensor NTC (see application note APT0406 on www.microsemi.com).

| Symbol | Characteristic | Min | Typ | Max | Unit |
|-----------------------------------|----------------------------|-----|------|-----|------|
| R ₂₅ | Resistance @ 25°C | | 50 | | kΩ |
| ΔR ₂₅ /R ₂₅ | | | 5 | | % |
| B _{25/85} | T ₂₅ = 298.15 K | | 3952 | | K |
| ΔB/B | T _C =100°C | | 4 | | % |

$$R_T = \frac{R_{25}}{\exp\left[B_{25/85}\left(\frac{1}{T_{25}} - \frac{1}{T}\right)\right]}$$

T: Thermistor temperature
R_T: Thermistor value at T

Thermal and package characteristics

| Symbol | Characteristic | Min | Max | Unit | |
|-------------------|--|---------------|-----------------------|------|-----|
| V _{ISOL} | RMS Isolation Voltage, any terminal to case t = 1 min, 50/60Hz | 4000 | | V | |
| T _J | Operating junction temperature range | -40 | 175 | °C | |
| T _{JOP} | Recommended junction temperature under switching conditions | -40 | T _{Jmax} -25 | | |
| T _{STG} | Storage Temperature Range | -40 | 125 | | |
| T _C | Operating Case Temperature | -40 | 100 | | |
| Torque | Mounting torque | To Heatsink | M6 | 3 | N.m |
| | | For terminals | M5 | 2 | |
| Wt | Package Weight | | 300 | g | |

SP6 Package outline (dimensions in mm)

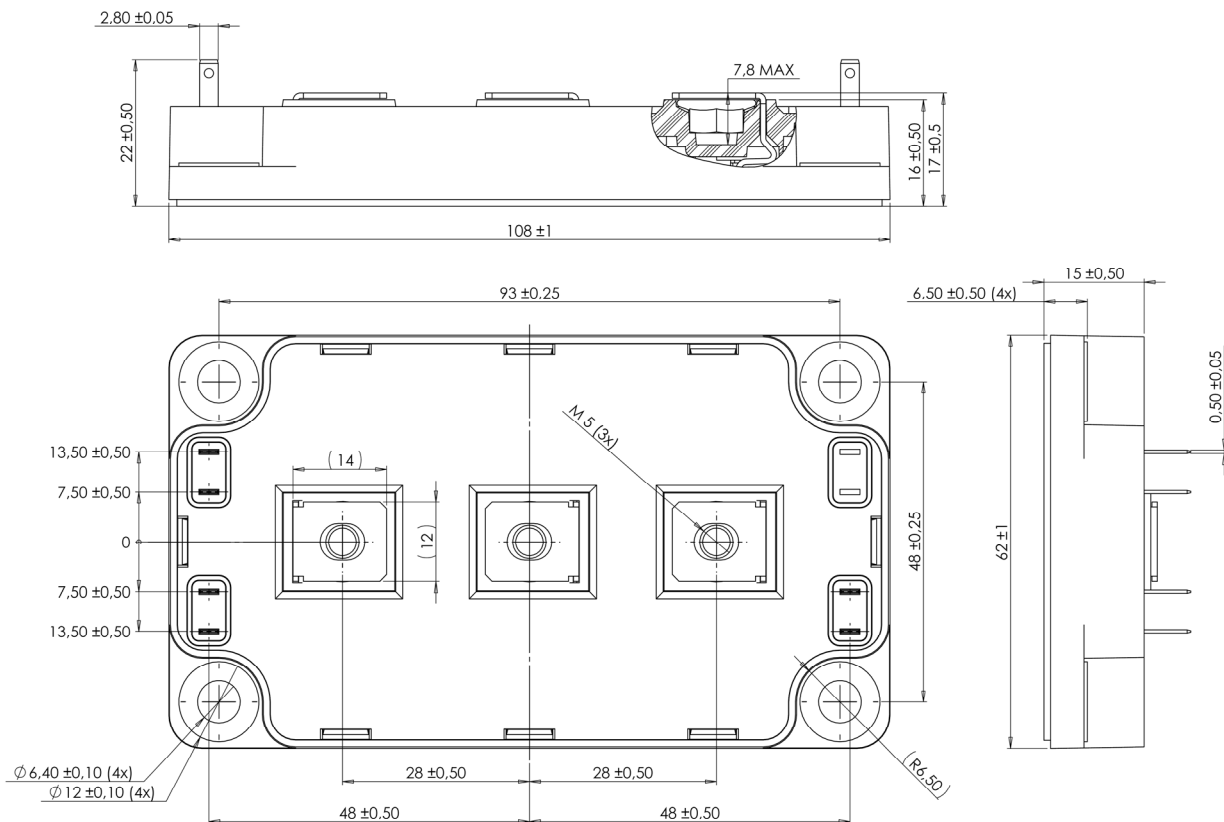

See application note APT0601 - Mounting Instructions for SP6 Power Modules on www.microsemi.com

Typical Performance Curve

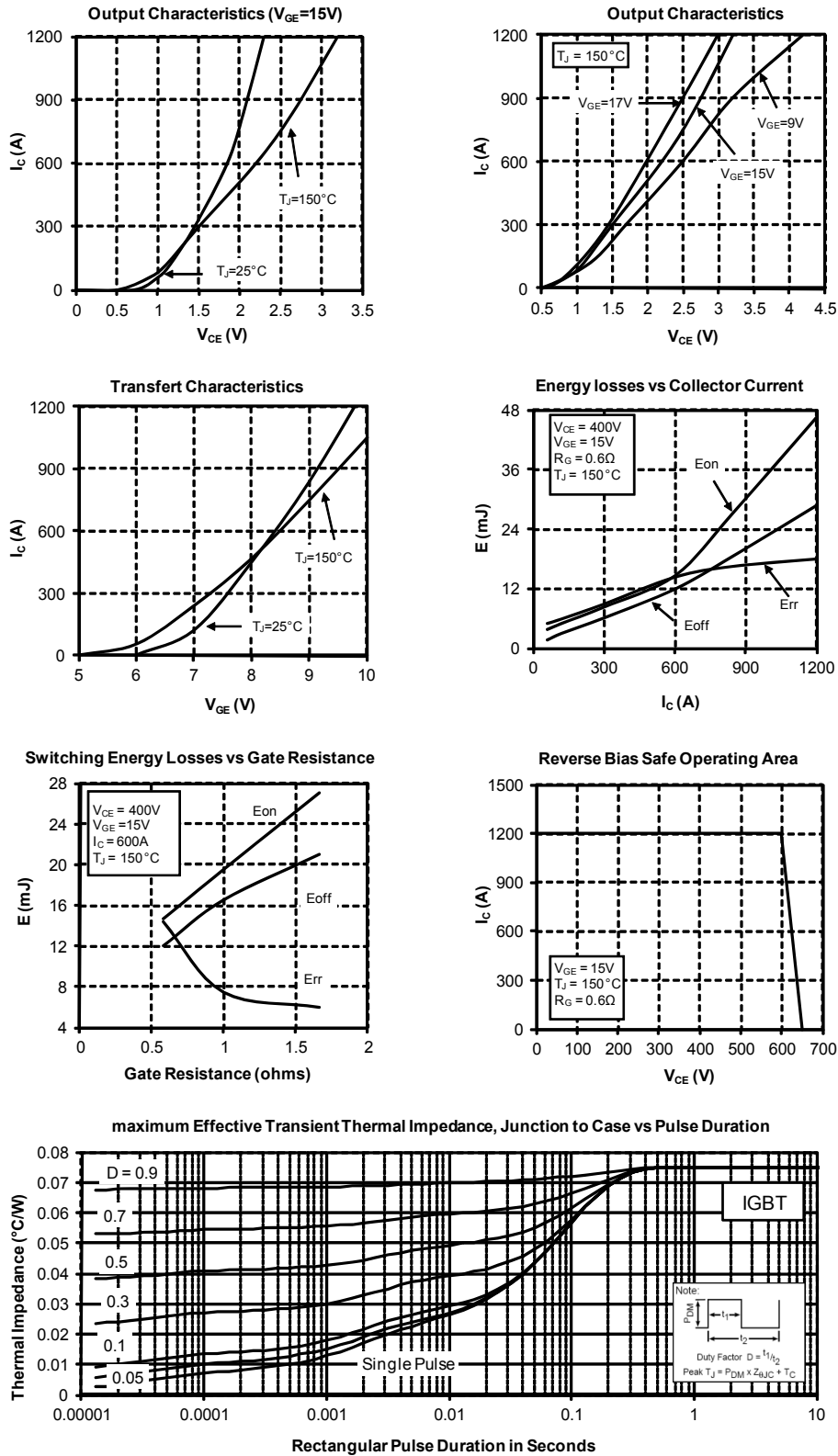

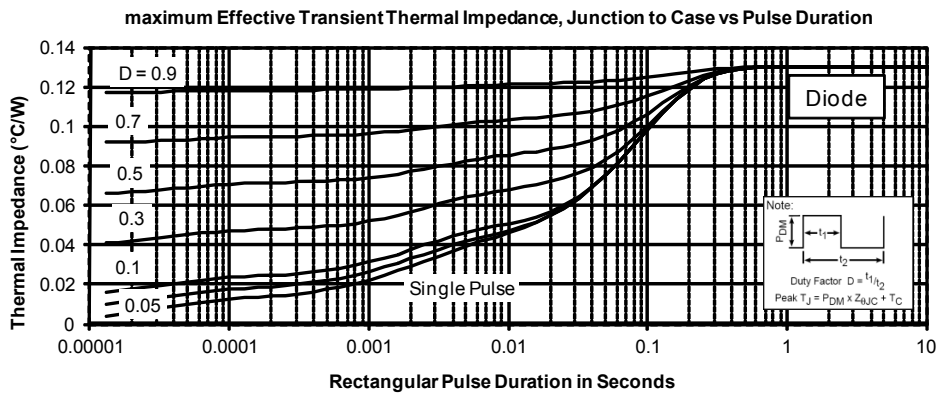
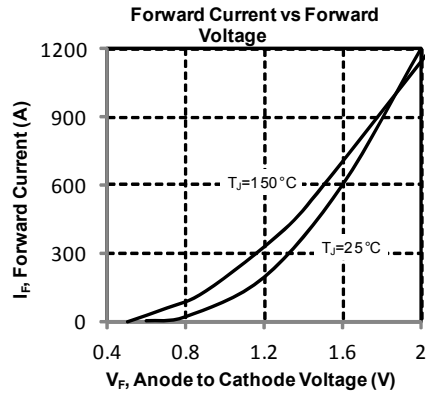
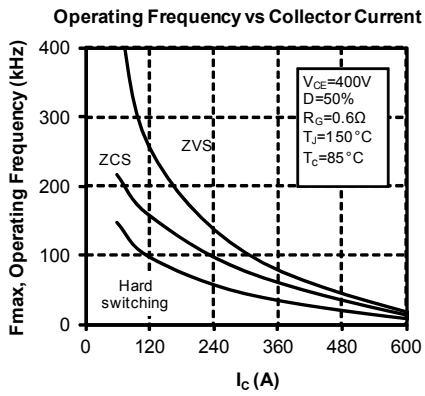

DISCLAIMER

The information contained in the document (unless it is publicly available on the Web without access restrictions) is PROPRIETARY AND CONFIDENTIAL information of Microsemi and cannot be copied, published, uploaded, posted, transmitted, distributed or disclosed or used without the express duly signed written consent of Microsemi. If the recipient of this document has entered into a disclosure agreement with Microsemi, then the terms of such Agreement will also apply. This document and the information contained herein may not be modified, by any person other than authorized personnel of Microsemi. No license under any patent, copyright, trade secret or other intellectual property right is granted to or conferred upon you by disclosure or delivery of the information, either expressly, by implication, inducement, estoppels or otherwise. Any license under such intellectual property rights must be approved by Microsemi in writing signed by an officer of Microsemi.

Microsemi reserves the right to change the configuration, functionality and performance of its products at anytime without any notice. This product has been subject to limited testing and should not be used in conjunction with life-support or other mission-critical equipment or applications. Microsemi assumes no liability whatsoever, and Microsemi disclaims any express or implied warranty, relating to sale and/or use of Microsemi products including liability or warranties relating to fitness for a particular purpose, merchantability, or infringement of any patent, copyright or other intellectual property right. Any performance specifications believed to be reliable but are not verified and customer or user must conduct and complete all performance and other testing of this product as well as any user or customers final application. User or customer shall not rely on any data and performance specifications or parameters provided by Microsemi. It is the customer's and user's responsibility to independently determine suitability of any Microsemi product and to test and verify the same. The information contained herein is provided "AS IS, WHERE IS" and with all faults, and the entire risk associated with such information is entirely with the User. Microsemi specifically disclaims any liability of any kind including for consequential, incidental and punitive damages as well as lost profit. The product is subject to other terms and conditions which can be located on the web at <http://www.microsemi.com/legal/tnc.asp>

Life Support Application

Seller's Products are not designed, intended, or authorized for use as components in systems intended for space, aviation, surgical implant into the body, in other applications intended to support or sustain life, or for any other application in which the failure of the Seller's Product could create a situation where personal injury, death or property damage or loss may occur (collectively "Life Support Applications").

Buyer agrees not to use Products in any Life Support Applications and to the extent it does it shall conduct extensive testing of the Product in such applications and further agrees to indemnify and hold Seller, and its officers, employees, subsidiaries, affiliates, agents, sales representatives and distributors harmless against all claims, costs, damages and expenses, and attorneys' fees and costs arising, directly or indirectly, out of any claims of personal injury, death, damage or otherwise associated with the use of the goods in Life Support Applications, even if such claim includes allegations that Seller was negligent regarding the design or manufacture of the goods.

Buyer must notify Seller in writing before using Seller's Products in Life Support Applications. Seller will study with Buyer alternative solutions to meet Buyer application specification based on Sellers sales conditions applicable for the new proposed specific part.

Данный компонент на территории Российской Федерации

Вы можете приобрести в компании MosChip.

Для оперативного оформления запроса Вам необходимо перейти по данной ссылке:

<http://moschip.ru/get-element>

Вы можете разместить у нас заказ для любого Вашего проекта, будь то серийное производство или разработка единичного прибора.

В нашем ассортименте представлены ведущие мировые производители активных и пассивных электронных компонентов.

Нашей специализацией является поставка электронной компонентной базы двойного назначения, продукции таких производителей как XILINX, Intel (ex.ALTERA), Vicor, Microchip, Texas Instruments, Analog Devices, Mini-Circuits, Amphenol, Glenair.

Сотрудничество с глобальными дистрибьюторами электронных компонентов, предоставляет возможность заказывать и получать с международных складов практически любой перечень компонентов в оптимальные для Вас сроки.

На всех этапах разработки и производства наши партнеры могут получить квалифицированную поддержку опытных инженеров.

Система менеджмента качества компании отвечает требованиям в соответствии с ГОСТ Р ИСО 9001, ГОСТ РВ 0015-002 и ЭС РД 009

Офис по работе с юридическими лицами:

105318, г.Москва, ул.Щербаковская д.3, офис 1107, 1118, ДЦ «Щербаковский»

Телефон: +7 495 668-12-70 (многоканальный)

Факс: +7 495 668-12-70 (доб.304)

E-mail: info@moschip.ru

Skype отдела продаж:

moschip.ru

moschip.ru_4

moschip.ru_6

moschip.ru_9