

Amphenol SOCAPEX

Board Level Products

Board to Board Interconnect Solutions

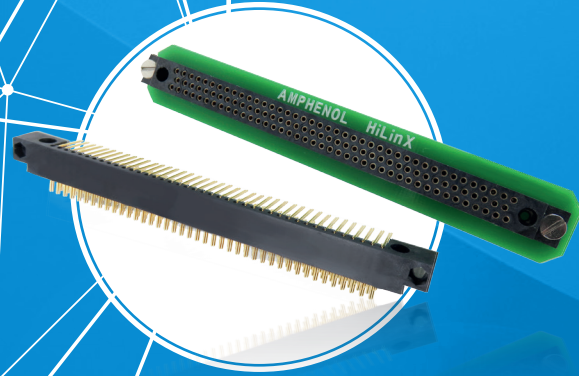

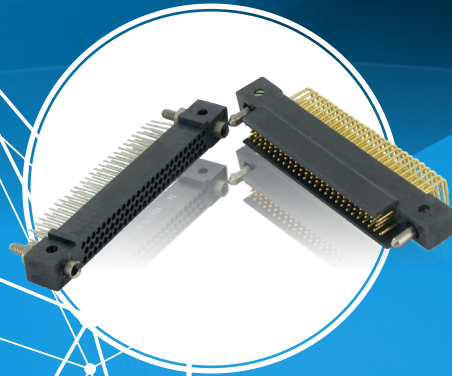
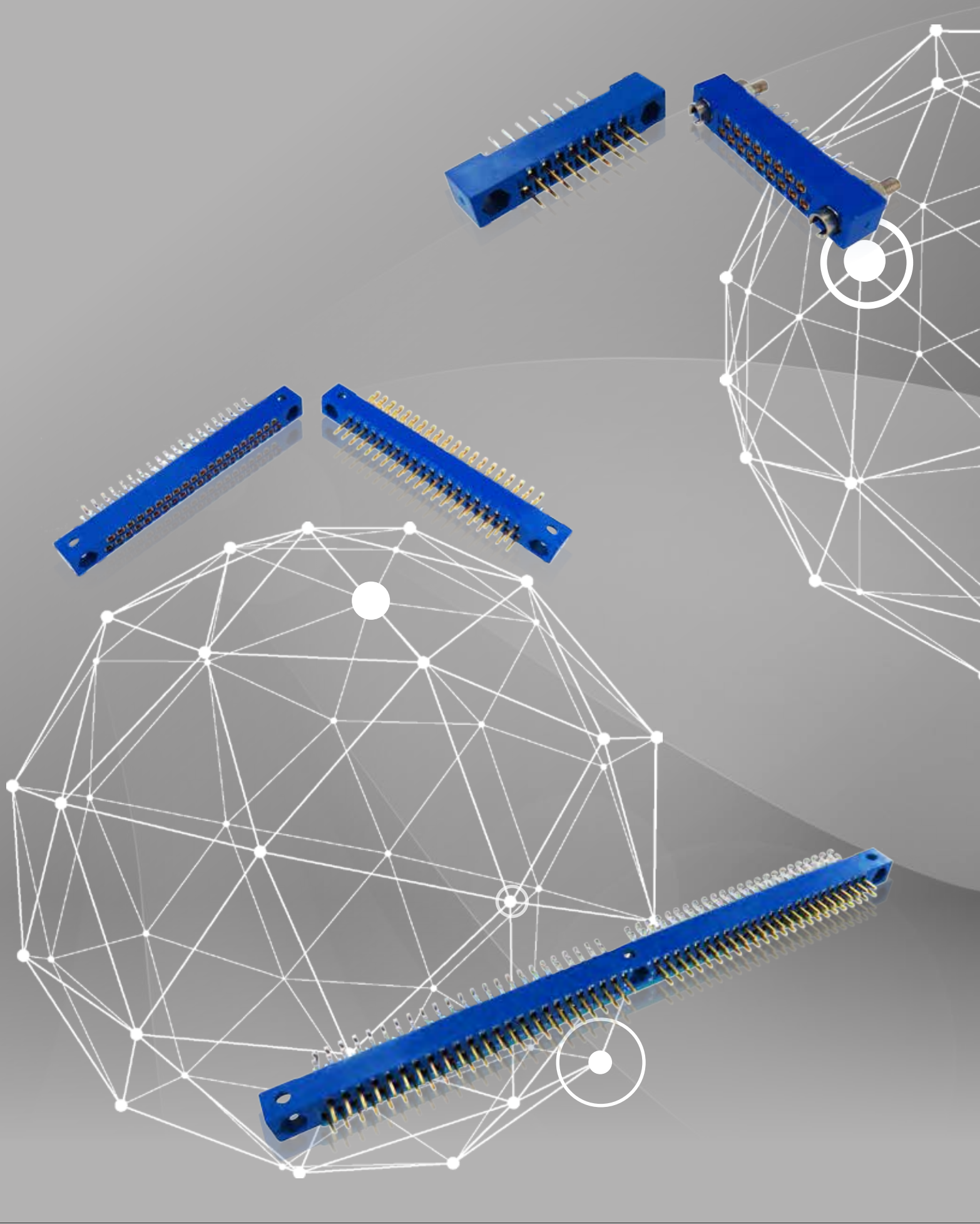

127/HE8: The well proven technology

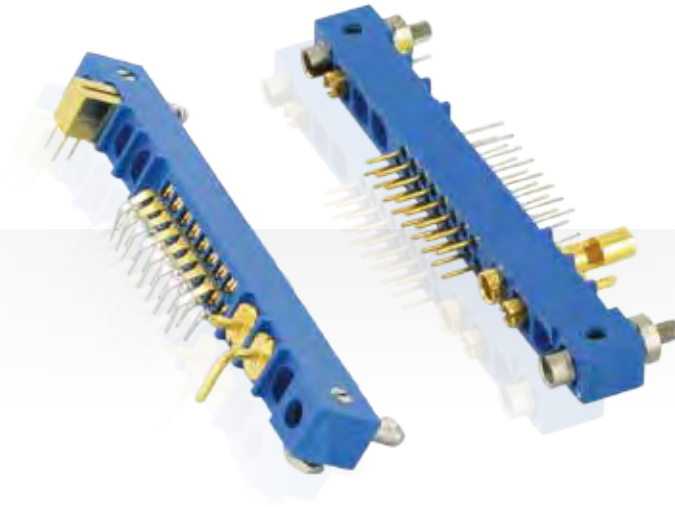

Table of contents

127/HE8 SERIES	115
General characteristics	116
Contacts	118
Receptacle & plug Fitting	120
HE801 plug & receptacle	120
HE807 plug & receptacle	122
HE804 plug & receptacle	124
HE801 special application plug & receptacle	126
HE807 special application plug & receptacle	128
HE804 special application plug & receptacle	130
Arrangements & layouts	132
Tooling	136
How to order	137
Cross references	138

THE 127/HE8 SERIES SERVES VARIOUS MARKETS, INCLUDING:



Military Aerospace



Commercial Aerospace



C4ISR



Ground Vehicles



Industrial

All dimensions are given for information only and are in mm [inch], except as otherwise specified | *in mm: 1mm=0.03937 inch

GENERAL CHARACTERISTICS - 127/HE8

The widest board to board or board to cable range

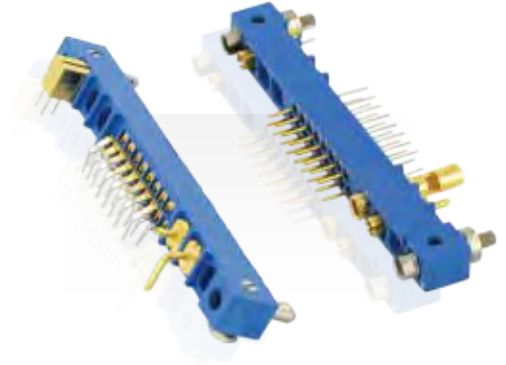

- Wide range of fittings, guiding and contact terminations
- Low-profile
- Cost competitive
- Reliable technology
- Board to board, board to cable or cable to cable versions
- Fully compatible with all the standard connectors on the market (HE801, HE804 & HE807)

Main features

- Turning fork and blade concept
- Hybrid patterns: 3 to 10 special cavities
- 36 keying possibilities

Contacts Terminations

Female

Male

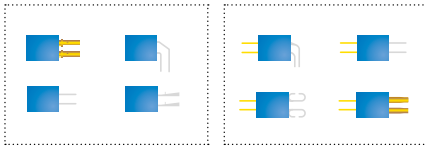

Recommended configurations

Mother board to daughterboard

Mezzanine

Board to cables

Cables to cables

Extender boards

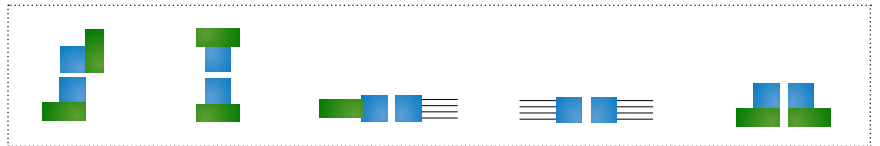

Overall dimensions

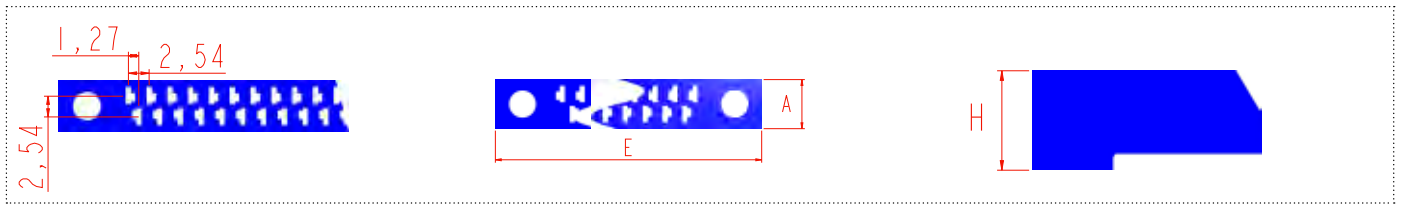

	HE801	HE804	HE807
H	7,9 [.311]	6,9 [.272]	7,9 [.311]
A	6,3 [.248] for 2-rows 8,55 to 8,94 [.337 to .352] for 3 rows	6,3 [.248] for 2-rows 8,55 to 8,94 [.337 to .352] for 3 rows	6,3 [.248] for 2-rows 8,55 to 8,94 [.337 to .352] for 3 rows
E	37,5 to 144,2 [1.476 to 5.677]	37,5 to 144,2 [1.476 to 5.677]	37,5 to 144,2 [1.476 to 5.677]

All dimensions are given for information only and are in mm [inch], except as otherwise specified | *in mm: 1mm=0.03937 inch

HDAS
HILINX¹⁰⁰⁵
SMASH
HDB3/HSB3
R-VPX
R-SATA

127/HE8

GENERAL CHARACTERISTICS - 127/HE8

STANDARD / APPROVALS

- NFC UTE 93424
 - HE801
 - HE804
 - HE807
- BS9525
 - N0001
 - F0006
 - F0007
- MIL DTL 55302
 - /140 to /155

TYPE OF CONTACTS

- Low level signal contacts: 3A
- Power contacts: 10A & 20A
- Coaxial contacts

CONNECTOR TYPES

- HE801: cylindrical pin
- HE804: rectangular pin
- HE807 / 127H : hybrid version
- F = Female contact
- M = Male contact

CONTACT DENSITY

- Medium density: 2.54 [.100] staggered grid (1.27 [.050] offset), 2.54 [.100] between rows

NUMBER OF ROWS

- 2 rows
- 3 rows

ARRANGEMENTS

- From 17 to 144 low level signal contacts
- From 0 to 10 special contacts: power or coaxial

FEMALE CONTACT

- Turning fork contact
- Selective plating
- Advanced copper alloys
- Optimized electrical conductivity
- Long-term mechanical reliability
- Selective plating



MATERIALS

Female contact

- CuSn9P, stamped and formed

Male contact

- CuZn, stamped and formed

Guiding devices

- Electroless nickel over brass or Passivated stainless steel 303

Plastic insert

- Thermoset DAP, 30% glass-fiber filled

PLATING

Contact terminations

- Tin lead or lead free on YD, Y, Z, ZC, YC, contacts
- Gold on X, X1 contacts

Active contact area

- Gold over Nickel

MALE CONTACT

Mating end diameter

- HE801 & HE807: cylindrical section $\varnothing 0.6$ [.024]
- HE804: rectangular section: 0,8x0,6 [.031 x .024]

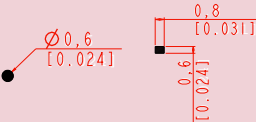

Technical specifications

Mechanical characteristics	127/HE8
Backoff ¹ (mm)	1 _{MAX} [.039]
Mating force per contact (N)	1,60 _{MAX}
Unmating force per contact (N)	0,14 _{MIN}
Durability cycles	500
Vibrations (10 to 2000 Hz) micro discontinuity 1ns	10 g
Shocks micro discontinuity 1µs	100 g
Recommended tightening torques Nuts for $\varnothing 2,5$ mm screws, brass (m.N)	0,25
Nuts for $\varnothing 1,6$ mm screws, brass (m.N)	0,15
Environmental characteristics	
Thermal shocks (°C)	-55 / + 125
Salt Spray (hours)	96
Electrical characteristics	
Current rating per contacts (A)	3 (see derating curve)
Insulation resistance (GΩ)	5 _{MIN}
Contact resistance (mΩ)	12 _{MAX}
Dielectric Withstanding Voltage (Vrms)	1000 _{MIN}
Service Voltage (at 50Hz) (Vrms)	250

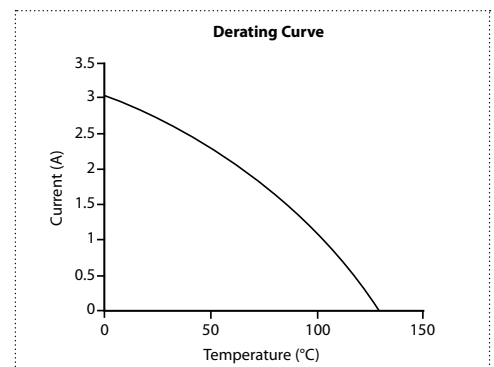

¹: When both connectors are fully mated, the backoff is the maximum distance the connectors can be unmated while functioning properly

All dimensions are given for information only and are in mm [inch], except as otherwise specified | *in mm: 1mm=0.03937 inch

SIGNAL CONTACTS

Female contacts

The mention ← or → means the contact removal direction

Right angle PC tail

- Thru hole soldering
- Single or double sided daughter board

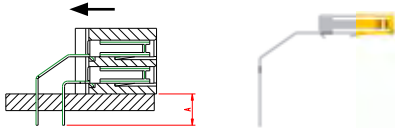

YC

Straight PC tail

- Thru hole soldering
- Mother board

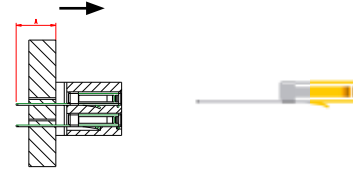

YD/Y

Solder cup

- Wire $\varnothing 1_{MAX} [.039]$ on core section $0,78mm^2 [.0012in^2]$
- Hard soldering on wire

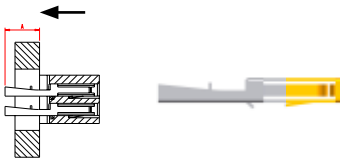

Z

Crimp barrel

- Crimping on wire
- AWG gauge 22 to 26
- Terminations protected by a casing cemented to the moulding

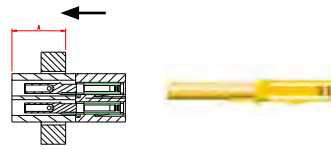

X1

Male contacts

Right angle PC tail

- Thru hole soldering
- Single or double sided daughter board

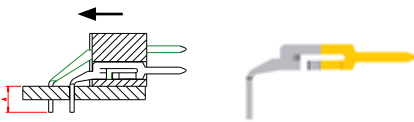

YC

Straight PC tail

- Thru hole soldering
- Mother board

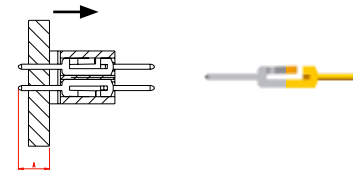

Y

Solder cup

- Hard soldering on wire
- Wire $\varnothing 1_{MAX} [.039]$ on core section $0,78mm^2 [.0012in^2]$

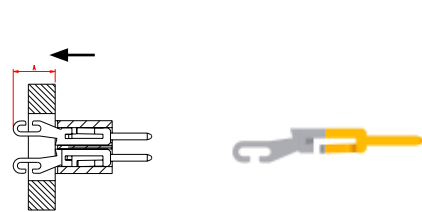

ZC

Crimp barrel

- Crimping on wire
- AWG gauge 22 to 26
- Termination protected by a casing cemented to the moulding
- Not available for HE801 & HE807 connectors

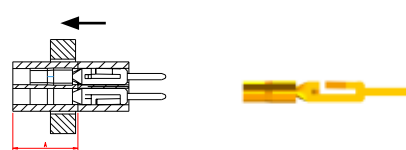

X

Contact type	Female					Male			
	YC	YD	Y	Z	X1	YC	Y	ZC	X
A HE801 / HE807	3[.118]	/	4,9[.193]	4,5[.177]	7[.276]	3,1[.122]	5,05[.199]	4,3[.169]	7[.276]
A HE804	3[.118]	4,7[.185]	/	5,5[.217]	8[.315]	3,1[.122]	5[.197]	5,3[.209]	8[.315]
PCB thickness	2[.079]	3,2[.126]	3,2[.126]	3,2[.126]	3,2[.126]	2,6[.102]	3,2[.126]	3,2[.126]	3,2[.126]
Termination section	0,2 x 0,5 [.020 x .007]	0,5 x 0,2 [.007 x .020]	0,5 x 0,2 [.007 x .020]	/	/	0,35 x 0,35 [.014 x .014]	0,35 x 0,35 [.014 x .014]	/	/

All dimensions are given for information only and are in mm [inch], except as otherwise specified | *in mm: 1mm=0.03937 inch

SPECIAL CONTACTS

Power contacts

Straight PC tail 10A

- Thru hole soldering
- Mother board

M141/F141



Right angle PC tail 10A

- Thru hole soldering
- Daughter board

M132/F132



Solder cup 10A

- Hard soldering on wire

M121/F121



Solder cup 20A

- Hard soldering on wire

MH1/FH1



Right angle PC tail 20A

- Thru hole soldering
- Daughter board

MH3/FH3



Straight PC tail 20A

- Thru hole soldering
- Mother board

MH2/FH2



Coaxial contacts

Straight PC tail

- Thru hole soldering
- Mother board

M041/F041



Straight on flexible cable

- Hard soldering on flexible cable

M011/F011



Right angle PC tail

- Thru hole soldering
- Daughter board

M032/F032



M021/F021

Contact type		A	Wire diameter	Termination section	PCB thickness
10A	M121/F121	8,2[.323]	2 _{MAX} [.079]	Ø 3,6[.142]	/
	M141/F141	3,8[.150]	/	Ø 1,2 [.047]	3,2 _{MAX} [.126]
	M132/F132	3,8[.150]	/	Ø 1,2 [.047]	1,6 to 2,4 [.063 to .095]
20A	MH1/FH1	6,3[.248]	1,83 _{MAX} [.072]	/	/
	MH2/FH2	4,2[.165]	/	1,4 [0.053]	3,2 _{MAX} [.126]
	MH3/FH3	3,8[.150]	/	1,2 [.047]	1,6 to 2,4 [.063 to .095]
Coaxial	M041/F041			3,8[.150]	
	M021/F021			9,2[.362]	
	M011/F011			2,5[.098]	
	M032/F032			6,2[.244] 2,54 [.100]	

All dimensions are given for information only and are in mm [inch], except as otherwise specified | *in mm: 1mm=0.03937 inch

HE801 PLUG FITTINGS, STANDARD, DAUGHTERBOARD

To order the fitting alone HE8C1** for brass ; HE8C3** for stainless steel

For standard applications, mounting on chassis or daughter board

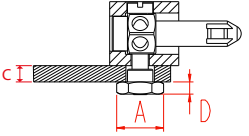
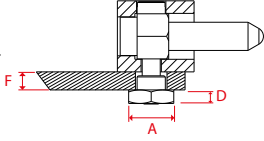
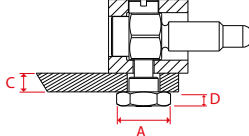
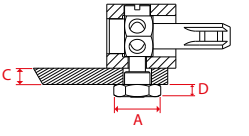
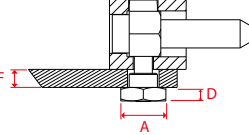
Contact	End Fittings						Central Fitting		Mating Receptacle Fittings			
	End Fitting	127 Ref.		Standard ref. HE 8 C	Description	Keying	Locking	Central Fitting	Standard Reference HE 8 C	Female ct.	Male ct.	Standard Reference HE8 C
		Female ct.	Male ct.									
YC		A	J	101	Daughter board with plated thru holes	✓	X		102	K P KE	A B AE	201 203 209
YC		D	S	103	Daughter board Lockable on receptacle side	X	✓			S	D	220
YC		AS	JS	124	Daughter board with plated thru holes Lockable on receptacle side	✓	✓			KD KED	AD AED	221 223
YC		PA	PC	102	Daughter board or extension board with plated thru holes	X	X			K P KE	A B AE	201 203 209

	HE8C101 A/J	HE8C103 D/S	HE8C124 AS/JS	HE8C102 PA/PC
A	Hex 4 [.157]	Hex 4 [.157]	Hex 4 [.157]	Hex 4 [.157]
C	1,6 to 2,4 [0.63 to 0.94]	1,6 to 2,4 [.063 to .094]	1,6 to 2,4 [.063 to .094]	1,6 to 2,4 [.063 to .094]
D	1,3 _{MAX} [.051]	1,3 _{MAX} [.051]	1,3 _{MAX} [.051]	1,3 _{MAX} [.051]

All dimensions are given for information only and are in mm [inch], except as otherwise specified | *in mm: 1mm=0.03937 inch

HE801 RECEPTACLE FITTINGS, STANDARD, MOTHERBOARD OR CHASSIS

To order the fitting alone HE8C2** for brass ; HE8C4** for stainless steel

For standard applications, mounting on chassis or mother board

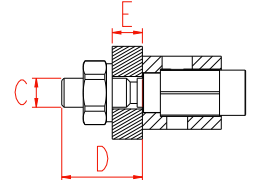
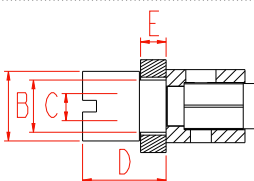
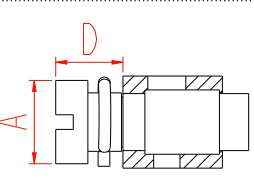
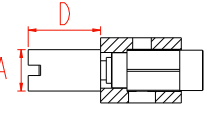
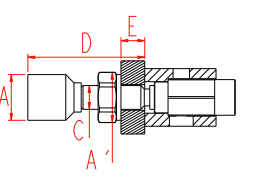
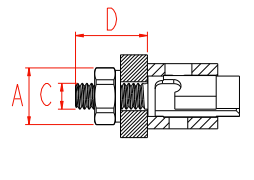
Male contact	Female contact	End Fittings						Central Fittings		Mating Plug Fittings			
		End Fitting	127 Ref		Standard ref. HE 8 C	Description	Keying	Locking	Central Fitting	Standard Reference HE 8 C	Female ct.	Male ct.	Standard Reference HE8C
			Female ct.	Male ct.									
ZC X Y	Z Y		K	A	212	Chassis or mother board	✓	X		229	A PA E	J PC R	101 102 110
ZC X Y YD	Z X1 Y YD		P	B	203	Chassis Lockable on receptacle side	✓	X		202	A PA E	J PC R	101 102 110
ZC X	Z		S	D	219	Chassis or mother board Board to board, board to chassis, parallel to one another, board to cable or chassis to cable Lockable on receptacle side	X	✓		229	D EF	S RF	103 112
ZC X Y	Z Y		KD	AD	221	Cable to board or cable to chassis Quarter turn locking Dimensions given in reset position	✓	✓			AS ES	JS RS	124 125
ZC X Y	Z Y		KT	AT	422	Chassis or mother board Fixed receptacle Quarter turn locking on plug side	✓	✓		429	ET	RT	327

	HE8C212 K/A	HE8C203 P/B	HE8C219 S/D	HE8C221 KD/AD	HE8C422 KT/AT
A	/	Ø6[.236]	Ø5,8[.228]	Ø5[.197]	Hex5[.197]
B	/	Hex 4,5[.177]	/	/	/
C	M2,5[.098]	/	/	M2,5[.098]	M2,5[.098]
D	6 _{MAX} [.236]	5,9[.232]	6 _{MAX} [.236]	25,1 _{MAX} [.988]	6 _{MAX} [.236]
E	3,2 _{MAX} [.126]	2,1 _{MAX} [.083]	2,1 _{MAX} [.083]	3,2 _{MAX} [.126]	/
F	2,3[.091]	/	/	/	/
A'	/	/	/	Hex5[.197]	/

All dimensions are given for information only and are in mm [inch], except as otherwise specified | *in mm: 1mm=0.03937 inch

HE807 PLUG FITTINGS, STANDARD, DAUGHTERBOARD

To order the fitting alone HE8C1** for brass ; HE8C3** for stainless steel
 For standard applications, mounting on daughter board

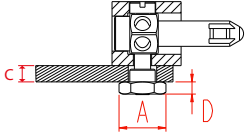
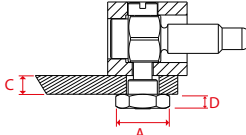
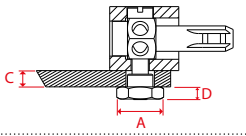
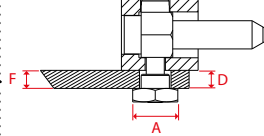
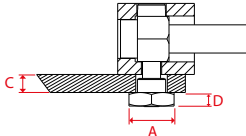
Contact	End Fittings						Central Fitting		Mating Receptacle Fittings	
	End Fitting	127 Ref.	Standard ref. HE 8 C	Description	Keying	Locking	Central Fitting	Standard Reference HE 8 C	127 ref	Standard Reference HE 8 C
YC		A	101	Daughter board with plated the holes	✓	X			K PT KE	212 210 208
YC		D	103	Daughter board Lockable on receptacle side	X	✓			S	213
YC		AS	124	Daughter board with plated thru holes Lockable on receptacle side	✓	✓		102	KD KED	221 224
YC		PA	102	Daughter board or extension board with plated thru holes	X	X			K P KE IE	212 226 208

	HE8C101 A	HE8C103 D	HE8C124 AS	HE8C102 PA
A	Hex 4[.157]	Hex 4[.157]	Hex 4[.157]	Hex 4[.157]
C	1,3 to 2,4[.63 to .94]	1,3 to 2,4[.63 to .94]	1,3 to 2,4[.63 to .94]	1,3 to 2,4[.63 to .94]
D	1,3 _{MAX} [.051]	1,3 _{MAX} [.051]	1,3 _{MAX} [.051]	1,3 _{MAX} [.051]

All dimensions are given for information only and are in mm [inch], except as otherwise specified | *in mm: 1mm=0.03937 inch

HE807 RECEPTACLE FITTINGS, STANDARD, MOTHERBOARD OR CHASSIS

To order the fitting alone HE8C2** for brass ; HE8C4** for stainless steel
 For standard applications, mounting on chassis or mother board

Male contact	Female contact	End Fittings					Central Fitting		Mating Plug Fittings		
		End Fitting	127 Ref.		Description	Keying	Locking	Central Fitting	Standard Reference HE 8 C	127 ref	Standard Reference HE 8 C
			Female ct.	Male ct.							
ZC X Y	Z YD		K	212	Chassis or mother board	✓	X		229	A PA E T	101 102 117 118
ZC X	Z		P	226	Chassis floating receptacle	✓	X		202	A PA E T	118101 102 117 118
ZC X	Z		S	213	Cables, free receptacle Locking device extractor Locking and unlocking shall be carried out simultaneously at both ends	X	✓		229	D E F	103 119
ZC X Y	Z YD		KD	221	Chassis or motherboard Fixed receptacle	✓	✓			A S E S	124 125
ZC X Y	Z YD		KT	422	Chassis or mother board Fixed receptacle Quarter turn locking on plug side	✓	✓		429	E T	327

	HE8C212 K	HE8C226 P	HE8C213 S	HE8C221 KD	HE8C422 KT
A	/	Ø6[.236]	Ø5.8[.228]	Ø5[.197]	Hex5[.197]
B	/	Hex 4,5[.177]	/	/	/
C	M2.5[.098]	/	/	M.2.5[.098]	M.2.5[.098]
D	6 _{MAX} [.236]	5.9[.232]	6 _{MAX} [.236]	25.1 _{MAX} [.988]	6 _{MAX} [.236]
E	3.2 _{MAX} [.126]	2.1 _{MAX} [.083]	2.1 _{MAX} [.083]	3.2 _{MAX} [.126]	/
F	2.3[.091]	/	/	/	/
A'	/	/	/	Hex5[.197]	/

All dimensions are given for information only and are in mm [inch], except as otherwise specified | *in mm: 1mm=0.03937 inch

HE804 PLUG FITTINGS, STANDARD, DAUGHTERBOARD

To order the fitting alone HE8C1** for brass ; HE8C3** for stainless steel
 For standard application, mounting on daughterboard

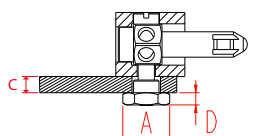
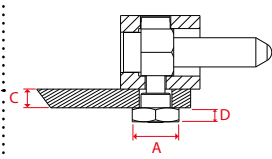
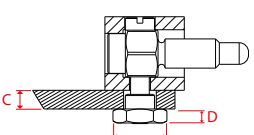
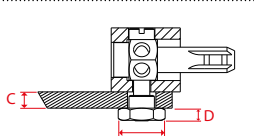
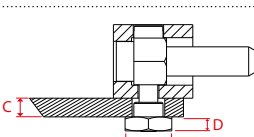
Contact	End Fittings						Central Fitting		Mating Receptacle Fittings			
	End Fittings	127 ref.		Standard ref.	Description	Keying	Locking	Central Fitting	Standard Reference HE 8 C	Female contact	Male contact	Standard Reference HE 8 C
		Female contact	Male contact	HE 8 C								
YC		A	J	101	Daughter board with plated thru holes	✓	X		102	K L P KE PD	A B AE	201 203 209
YC		D	S	103	Daughter board Lockable on receptacle side	X	✓			S PD	D PB	220
YC		AS	JS	124	Daughter board with plated thru holes Lockable on receptacle side	✓	✓			KD KED PD	AD AED PB	221 223
YC		PA	PC	102	Daughter board with plated thru holes	X	X			K L P KE PD	A B AE PB	201 203 209

	HE8C101 A/J	HE8C103 D/S	HE8C124 AS/JS	HE8C102 PA/PC
A	Hex 4 [.157]	Hex 4 [.157]	Hex 4 [.157]	Hex 4 [.157]
C	1,6 to 2,4 [.063 to .094]	1,6 to 2,4 [.063 to .094]	1,6 to 2,4 [.063 to .094]	1,6 to 2,4 [.063 to .094]
D	1,3 _{MAX} [.051]	1,3 _{MAX} [.051]	1,3 _{MAX} [.051]	1,3 _{MAX} [.051]

All dimensions are given for information only and are in mm [inch], except as otherwise specified | *in mm: 1mm=0.03937 inch

HE804 RECEPTACLE FITTINGS, STANDARD, MOTHERBOARD OR CHASSIS

To order the fitting alone HE8C2** for brass ; HE8C4** for stainless steel
 For standard applications, mounting on chassis or mother board

Male contact	Female contact	End Fittings						Central Fitting		Mating Plug Fittings			
		End Fitting	Amphenol Reference			Description	Keying	Locking	Central Fitting	Standard Reference HE 8 C	Female contact	Male contact	Standard Reference HE 8 C
			Female contact	Male contact	HE 8 C								
ZC X Y	Z YD		K	A	201	Chassis or mother board	✓	X			A PA E	J PC R	101 102 110
	Z YD X1		L	/	228	Chassis or mother board With insulating washer	✓	X			A PA E	J PC R	101 102 110
ZC X	Z		P	B	203	Chassis Floating receptacle	✓	X		202	A PA E	J PC R	101 102 110
ZC X	Z		S	D	220	Cables, free receptacle Locking device extractor-Locking and unlocking shall be carried out simultaneously at both ends	X	✓			D EF	S RF	103 112
ZC X Y	Z YD		KD	AD	221	Chassis or mother board Fixed receptacle. Captive locking screw into the body of the fitting	✓	✓			A S E	J S R	124 125
ZC X Y	Z YD		KT	AT	422	Chassis or mother board Fixed receptacle Quarter turn locking on plug side	✓	✓		402	E T	R T	327

	HE8C201 K/A	HE8C228 L	HE8C203 P/B	HE8C220 S/D	HE8C221 KD/AD	HE8C422 KT/AT
A	/	Hex 5 [.197]	Ø 6 [.236]	Ø 5,7 [.224]	Ø 5 [.197]	Hex 5 [.197]
B	/	/	Ø 4,5 [.177]	/	/	/
C	M 2,5 [.098]	M 2,5 [.098]	M 2,5 [.098]	/	M 2,5 [.098]	M 2,5 [.098]
D	6 MAX [.236]	6 MAX [.236]	7,2 [.283]	4,7 MAX [.185]	26,1 MAX [1.028]	7 MAX [.276]
E	3,2 MAX [.126]	2,7 MAX [.106]	2,2 [.087]	/	3,2 MAX [.126]	/
A'	/	/	/	/	Hex 5 [.197]	/

All dimensions are given for information only and are in mm [inch], except as otherwise specified | *in mm: 1mm=0.03937 inch

HDAS
HILINX®
SMASH
HDB³/HSB³
R-VPX
R-SATA
127/HE8

HE801 PLUG FITTINGS, SPECIAL APPLICATIONS

To order the fitting alone HE8C1** for brass ; HE8C3** for stainless steel

Plug fittings for special applications, mounting on chassis, mother board or wires

127/HE8

Male contact	Female contact	End Fittings						Central Fitting		Mating Receptacle Fittings			
		End Fittings	127 Ref.		Standard ref. HE 8 C	Description	Keying	Locking	Central Fitting	Standard Reference HE 8 C	Female ct.	Male ct.	Standard Reference HE 8 C
			Female ct.	Male ct.									
ZC X Y	Z YD		E	R	117	Chassis or mother board Board to board, board to chassis or mezzanine	✓	X		129	K P KE	A B AE	201 203 209
			T	T	118		✓	X					
ZC X Y	Z YD		EF	RF	119	Chassis or mother board Board to board, board to chassis, mezzanine board to cable or chassis to cable Lockable on receptacle side	X	✓					
ZC X Y	Z YD		ES	RS	125		✓	✓					
ZC X	Z		ET	RT	327	Cable to board or cable to chassis Quarter turn locking	✓	✓			329	KT KET	AT AET

	HE8C117 E/R	HE8C118 T	HE8C119 EF/RF	HE8C125 ES/RS	HE8C327 ET/RT
A			Hex 5 [.197]		Ø 6 [.236]
C			M 2,5 [.098]		/
D		6 _{MAX} [.236]		7 _{MAX} [.276]	16 _{MAX} [.630]
F	3,2 _{MAX} [.126]	/	3,2 _{MAX} [.126]	3,2 _{MAX} [.126]	/

All dimensions are given for information only and are in mm [inch], except as otherwise specified | *in mm: 1mm=0.03937 inch

HE801 RECEPTACLE FITTINGS, SPECIAL APPLICATIONS

To order the fitting alone HE8C2** for brass ; HE8C4** for stainless steel

Receptacle fittings for special applications, mounting on daughterboard

Contact	End Fittings						Central Fitting		Mating Plug Fittings			
	End Fittings	127 Ref.		Standard ref. HE 8 C	Description	Keying	Locking	Central Fitting	Standard Reference HE 8 C	Female ct.	Male ct.	Standard Reference HE 8 C
		Female ct.	Male ct.									
		KE	AE	208	Connection board to board aligned with each other With bracket	✓	X		208	A PA E	J PC R	101 102 110
YC		KED	AED	224	Connection board to board aligned with each other. Captive locking screw into the body of the fitting With bracket	✓	✓			AS ES	JS RS	124 125
		KET	AET	425	Daughter board. Board to cable. Quarter turn locking on plug side	✓	✓		425	ET	RT	327

	HE8C208 KE/AE	HE8C224 KED/AED	HE8C425 KET/AET
A	Ø 3,5 [.138]	Ø 5 [.197]	Hex 5 [.197]
C	/	Ø 3,5 [.138]	M 2,5 [.098]
D	4,6 [.181]	13 ^{MAX} [.197]	4,1 ^{MAX} [.161]
E	1,6 to 2,4 [.063 to .094]	/	/
F	2,35 [.093]	/	/
G	7,2 ^{MAX} [.283]	/	/
A'	M 2,5 [.098]	/	Hex 4 [.157]
H	5,5 [.217]	4,6 [.181]	/
D'	/	/	/

All dimensions are given for information only and are in mm [inch], except as otherwise specified | *in mm: 1mm=0.03937 inch

HE807 PLUG FITTINGS, SPECIAL APPLICATIONS

To order the fitting alone HE8C1** for brass ; HE8C3** for stainless steel

Plug fittings for special applications, mounting on chassis, mother board or wires

Male contact	Female contact	End Fittings					Central Fitting		Mating Receptacle Fittings		
		End Fittings	127 Ref.		Description	Keying	Locking	Central Fitting	Standard Reference HE 8 C	127 Ref.	Standard Ref. HE 8 C
			Female ct.	Male ct.							
ZC X Y	Z Y		E	117	Chassis or mother board Board to board, board to chassis or mezzanine	✓	X			K P	212 226 208 206
			T	118		X	X				
ZC X Y	Z Y		EF	119	Chassis or mother board Board to board, board to chassis, mezzanine, board to cable or chassis to cable	X	✓		129	S	213
	Z Y		ES	125	Lockable on receptacle side	✓	✓			KD	221 224
ZC X	Z		ET	327	Cable to board or cable to chassis Quarter turn locking	✓	✓		329	KT KET	422 425

	HE8C117 E/R	HE8C118 T	HE8C119 EF/RF	HE8C125 ES/RS	HE8C327 ET/RT
A			Hex 5 [.197]		Ø 6 [.236]
C			M 2,5 [.098]		/
D		6 MAX [.236]		7 MAX [.276]	16 MAX [.630]
F	3,2 MAX [.126]	/	3,2 MAX [.126]	3,2 MAX [.126]	/

All dimensions are given for information only and are in mm [inch], except as otherwise specified | *in mm: 1mm=0.03937 inch

HE807 RECEPTACLE FITTINGS, SPECIAL APPLICATIONS

To order the fitting alone HE8C2** for brass ; HE8C4** for stainless steel

Receptacle fittings for special applications, mounting on daughter board

Contact	End Fittings					Central Fitting		Mating Plug Fittings		
	End Fittings	127 Ref.		Description	Keying	Locking	Central Fitting	Standard Reference HE 8 C	127 Ref	Standard Ref HE 8 C
		Female ct.	Male ct.							
YC		KE	208	Connection board to board aligned with each other With bracket	✓	X		208	A PA E T	101 102 117 118
		KED	224	Connection board to board aligned with each other Captive locking screw into the body of the fitting With bracket	✓	✓			AS	124
		KET	425	Daughter board Board to cable Quarter turn locking on plug side	✓	✓		425	ET	327

	HE8C208 KE/AE	HE8C224 KED/AED	HE8C425 KET/AET
A	Ø 3,5 [.138]	Ø 5 [.197]	Hex 5 [.197]
C	/	Ø 3,5 [.138]	M 2,5 [.098]
D	4,6 [.181]	13 _{MAX} [.197]	4,1 _{MAX} [.161]
E	1,6 to 2,4 [.063 to .094]	/	/
F	2,35 [.093]	/	/
G	7,2 _{MAX} [.283]	/	/
A'		M 2,5 [.098]	Hex 4 [.157]
H	5,5 [.217]	4,6 [.181]	/
D'	/	/	/

All dimensions are given for information only and are in mm [inch], except as otherwise specified | *in mm: 1mm=0.03937 inch

HE804 PLUG FITTINGS, SPECIAL APPLICATIONS

To order the fitting alone HE8C1** for brass ; HE8C3** for stainless steel

Plug fittings for special applications, mounting on chassis, motherboard or wires

127/HE8

Male contact	Female contact	End Fittings						Central Fitting		Mating Receptacle Fittings			
		End Fittings	127 ref.		Standard ref. HE 8 C	Description	Keying	Locking	Central Fitting	Standard Reference HE 8 C	Female ct.	Male ct.	Standard Reference HE7 C
			Female ct.	Male ct.									
ZC X Y	Z YD		E	R	110	Chassis or mother board Board to board, board to chassis or mezzanine	✓	X		113	K L P KE	A B AE	201 203 209
			T	T	111		✓	X					
ZC X Y	Z YD		EF	RF	112	Chassis or mother board Board to board, board to chassis, mezzanine, board to cable or chassis to cable Lockable on receptacle side	X	✓			S	D	220
ZC X Y	Z YD		ES	RS	125		✓	✓			KD KED	AD AED	221 223
ZC X	Z		ET	RT	327	Cable to board or cable to chassis Quarter turn locking	✓	✓		313	KT KET	AT AET	422 425

	HE8C110 E/R	HE8C111 T	HE8C112 EF/RF	HE8C125 ES/RS	HE8C327 ET/RT
A	Hex 5 [.197]		Hex 5 [.197]		Ø 6 [.236]
C			M 2.5 [.098]		/
D		6 _{MAX} [.236]		7 _{MAX} [.276]	16 _{MAX} [.630]
F	3.2 _{MAX} [.126]	/	/	/	/

All dimensions are given for information only and are in mm [inch], except as otherwise specified | *in mm: 1mm=0.03937 inch

HE804 RECEPTACLE FITTINGS, SPECIAL APPLICATIONS

To order the fitting alone HE8C2** for brass ; HE8C4** for stainless steel

Receptacle fittings for special applications, mounting on daughter board

Contact	End Fittings						Central Fitting		Mating Plug Fittings			
	End Fittings	127 ref.		Standard ref. HE 8 C	Description	Keying	Locking	Central Fitting	Standard Reference HE 8 C	Female ct.	Male ct.	Standard Reference HE7 C
		Female ct.	Male ct.									
YC		KE	AE	209	Connection board to board aligned with each other With bracket	✓	x		209	A PA E	J PC R	101 102 110
		KED	AED	223	Connection board to board aligned with each other. Captive locking screw into the body of the fitting With bracket	✓	✓		209	AS ES	JS RS	124 125
		KET	AET	425	Daughter board. Board to cable. Quarter turn locking on plug side	✓	✓		425	ET	RT	327

	HE8C209 KE/AE	HE8C223 KED/AED	HE8C425 KET/AET
A	∅ 3,5 [.138]	∅ 5 [.197]	Hex [0.197]
B	1 _{MAX} [.039]	/	/
C	/	∅ 3,5 [.138]	M 2,5 [.098]
D	/	14 _{MAX} [.551]	4,1 _{MAX} [.161]
A'	Hex 4 [.157]	/	Hex 4 [.157]
E	1,6 to 2,4 [.063 to .094]	1,6 to 2,4 [.063 to .094]	/
F	3,35 [.132]	/	/
G	7,2 _{MAX} [.283]	/	/

All dimensions are given for information only and are in mm [inch], except as otherwise specified | *in mm: 1mm=0.03937 inch

ARRANGEMENTS & LAYOUTS

Arrangements - HE801 & HE804 - 3 rows

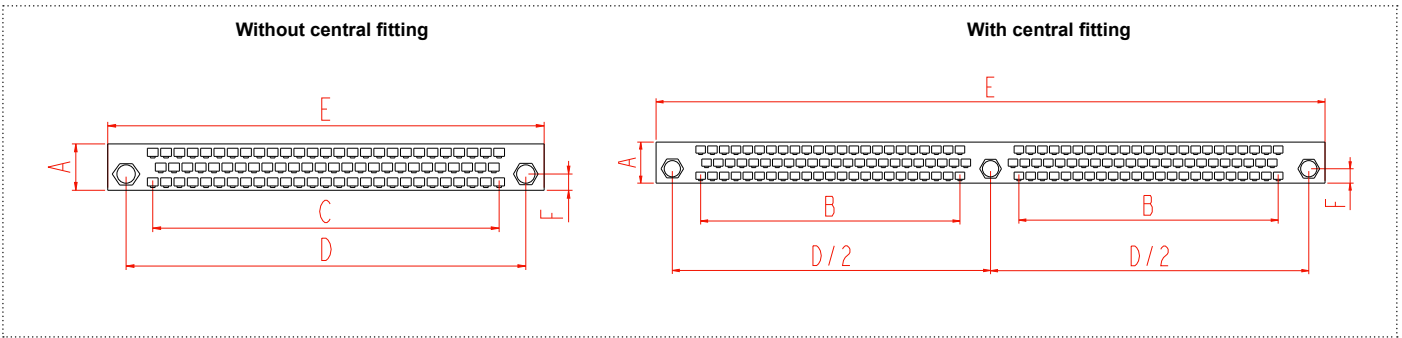

	80
A	8,94[0.35]
C	66,04[2.6]
D	76,3[3]
E	83,4[3.28]
F	3,1[0.12]

	144
A	8,55[0.34]
B	58,42[2.3]
D	137,16[5.4]
E	144,36[5.68]
F	3,1[0.12]

Arrangements - 2 rows

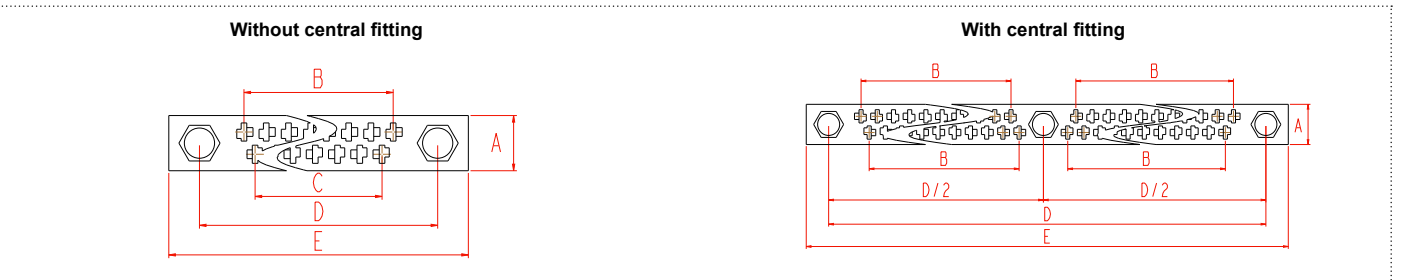

	17	29	33	41	53	65
A	6,3[0.25]	6,3[0.25]	6,3[0.25]	6,3[0.25]	6,3[0.25]	6,3[0.25]
B	20,32[0.8]	35,56[1.4]	40,64[1.6]	50,8[2]	66,04[2.6]	81,28[3.2]
C	17,78[0.7]	33,02[1.3]	38,1[1.5]	48,26[1.9]	63,5[2.5]	78,74[3.1]
D	30,48[1.200]	45,72[1.771]	50,80[2.000]	60,96[2.400]	76,20[3.000]	91,44[3.600]
E	37,5[1.476]	52,7[2.075]	57,8[2.275]	68,0[2.677]	83,2[3.275]	98,5[3.878]

	72	84	96
A	6,3[0.25]	6,3[0.25]	6,3[0.25]
B	43,18[1.7]	50,8[2]	58,42[2.3]
D	106,68[4.2]	121,92[4.8]	137,16[5.4]
E	113,7[4.48]	128,94[5.08]	144,2[5.68]

All dimensions are given for information only and are in mm [inch], except as otherwise specified | *in mm: 1mm=0.03937 inch

ARRANGEMENTS & LAYOUTS

Layouts - 2 rows

The boards are shown from the connector side. The drawings show connectors with central fitting. For smaller connector, omit the center drilling. All contacts outputs are equidistant.

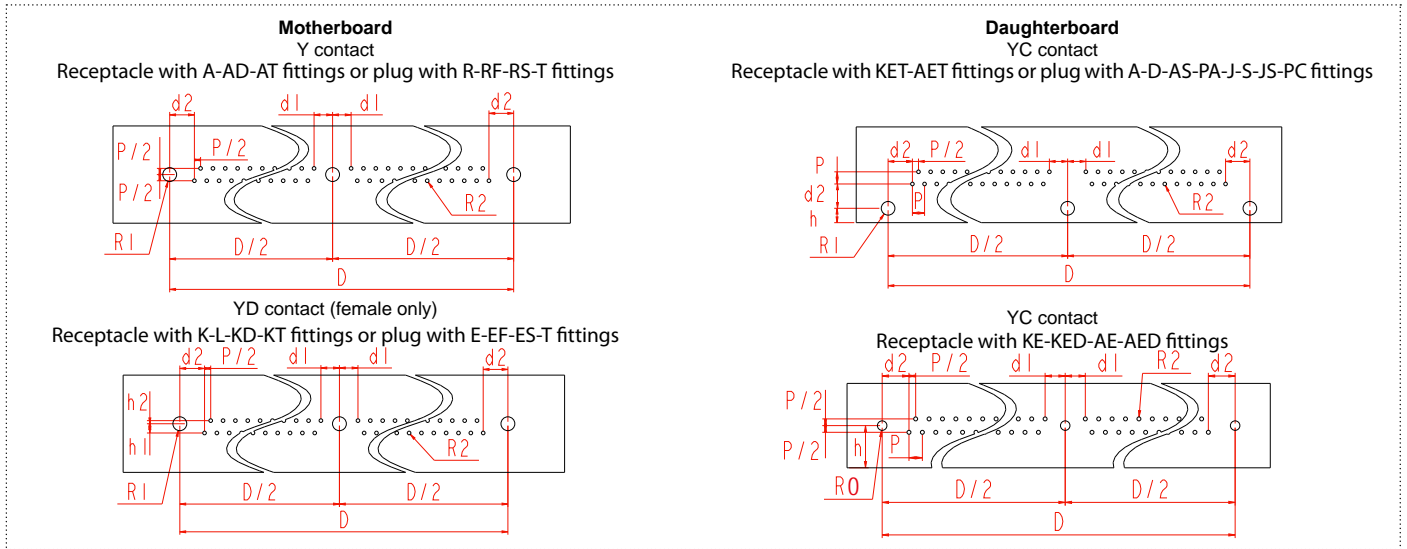

D	d ₁	d ₂	p	p ₂	h	h ₁	h ₂	h ₄	R ₀	R ₁	R ₂
See previous page	3,81 [.150]	5,08 [.200]	2,54 [.100]	1,27 [.050]	3 _{MAX} [.118]	1,9 [.075]	0,64 [.025]	8 _{MAX} [-315]	Ø 1,8 _{MIN} [.071]	Ø 2,85 _{MIN} [.112]	Ø 0,75 _{MIN} [.030]

Panel drilling - 2 rows

Receptacle with A-AD-AT fittings or plug with R-RF-RS-T fittings with male contact ZC-X
Receptacle with K-KD-KT-L fittings or plug with E-EF-ES-T fittings with female contact Z

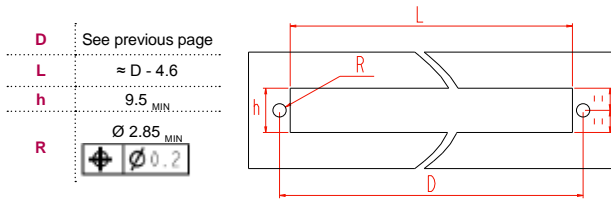

Receptacle with B fitting and male contact ZC-X
Receptacle with P fitting and female contact Z

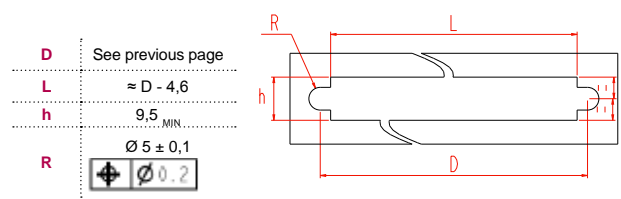

All dimensions are given for information only and are in mm [inch], except as otherwise specified | *in mm: 1mm=0.03937 inch

ARRANGEMENTS & LAYOUTS

Arrangements - signal + 3 cavities

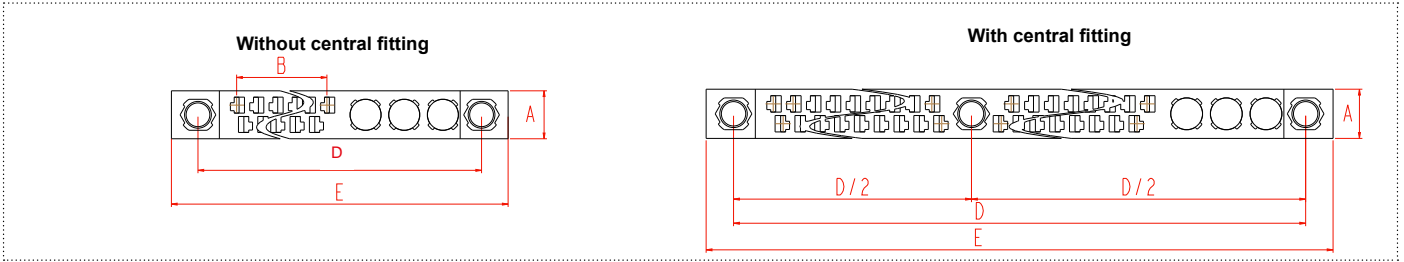

	5+3	17+3
A	6,3 ^{+0.1} [.25 ^{+0.04}]	
B	5,08[0.2]	20,32[0.8]
D	30,48[1.2]	45,72[1.8]
E	37,48[1.48]	52,72[2.08]

Note:
 • Asymmetrical arrangements with female contacts always have plug marking
 • Asymmetrical arrangements with male contacts always have receptacle marking

	60+3	84+3
A	6,3[0.25]	6,3[0.25]
D	106,68[4.2]	137,16[5.4]
E	113,68[4.48]	144,16[5.68]

Arrangements - signal + 6 cavities

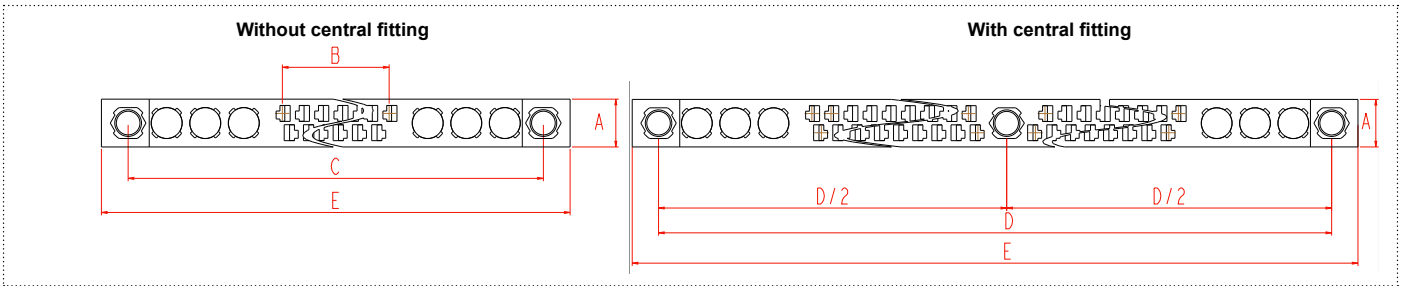

	5+6	17+6	29+6	41+6
A		6,3 ^{+0.1} [.25 ^{+0.04}]		
B	5,08[0.2]	20,32[0.8]	35,56[1.4]	50,8[2]
C	45,72[1.8]	60,96[2.4]	76,2[3]	91,44[3.6]
E	52,72[2.08]	67,96[2.68]	83,2[3.28]	98,44[3.88]

	72+6
A	6,3[0.25]
D	137,16[5.4]
E	144,16[5.68]

Panel drilling

F011 / M011-F021 / M021-F121 / M121-FH1 / MH1 contacts.

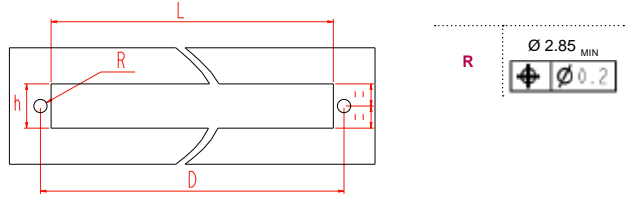

Receptacle with K-KD-KT fittings or plug with E-EF-ES fittings and male contacts ZC-X.
 Receptacle with K-KD-KT fittings or plug with E-EF-ES fittings and female contacts ZC-X1.

F011 / M011-F021 / M021-F121 / M121-FH1 / MH1 contacts.

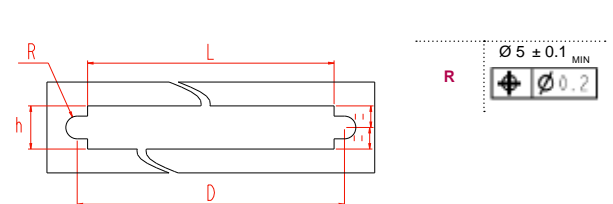

Receptacle with P fitting with male contacts ZC-X.
 Receptacle with P fitting with female contact ZC-X1.

D	L	h	d ₁	d ₂	p	p ₂	h ₀	h ₁	h ₂	R ₁	R ₂
See above	D-4,6	9,5 _{MIN}	3,81 [.150]	5,08 [.200]	2,54 [.100]	1,27 [.050]	3 _{MAX} [.118]	1,9 [.075]	0,64 [.025]	Ø 2,85 _{MIN} [.112] ⊕ ⊖ 0.2	Ø 0,75 _{MIN} [.030] ⊕ ⊖ 0.2

All dimensions are given for information only and are in mm [inch], except as otherwise specified | *in mm: 1mm=0.03937 inch

ARRANGEMENTS & LAYOUTS

Layouts- Power

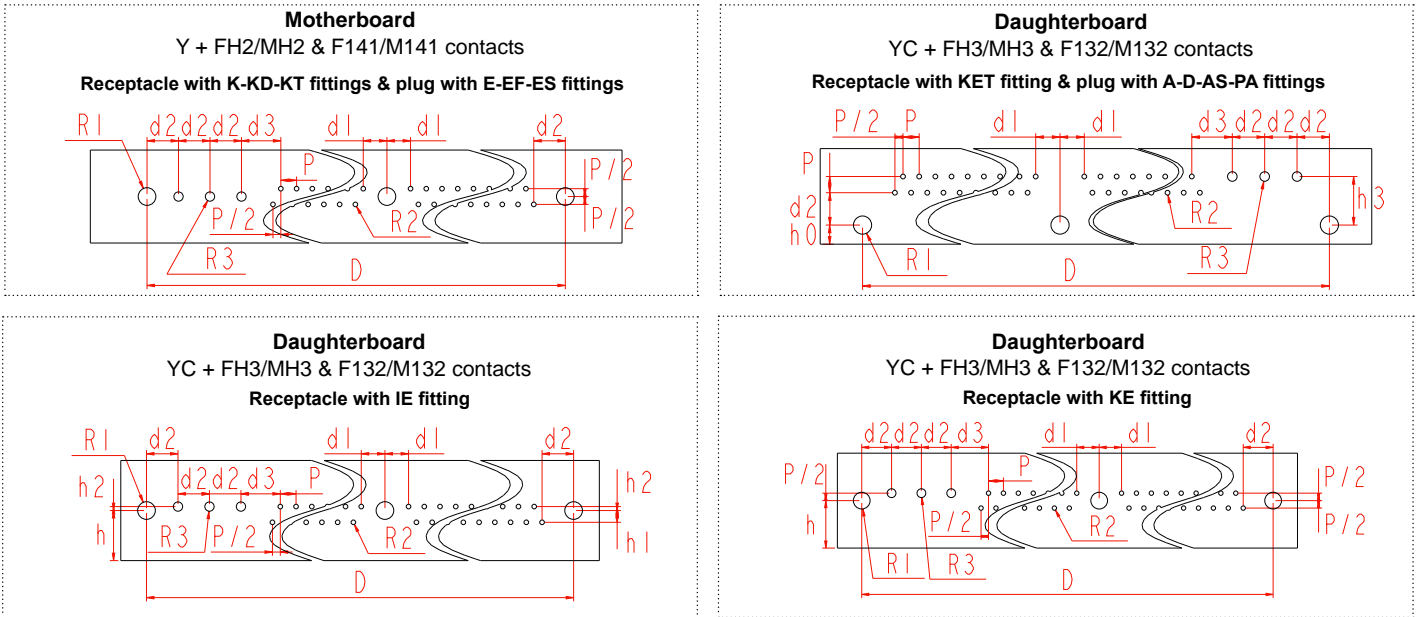

D	d ₁	d ₂	d ₃	p	p ₂	h ₀	h ₁	h ₂	h ₃	R ₁	R ₂	h
See previous page	3,81 [.150]	5,08 [.200]	6,35 [.250]	2,54 [.100]	1,27 [.050]	3 _{MAX} [.118]	1,9 [.075]	0,64 [.025]	7,62 [.300]	∅ 2,85 _{MIN} [.112]	∅ 0,75 _{MIN} [.030]	9,35 [.368]

Layout - Coaxial

The boards are shown from the connector side. The drawings show connectors with a central fitting. For smaller connector, omit the center drilling. All contacts outputs are equidistant.

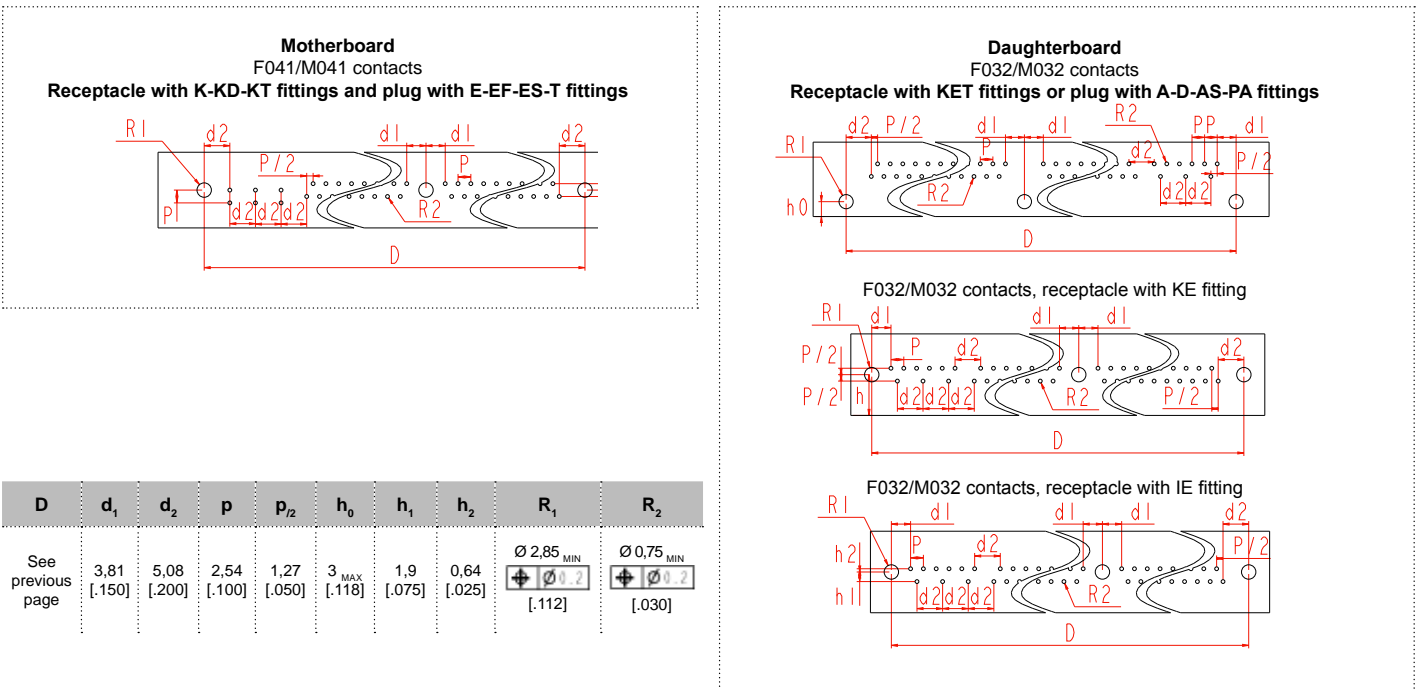

D	d ₁	d ₂	p	p ₂	h ₀	h ₁	h ₂	R ₁	R ₂
See previous page	3,81 [.150]	5,08 [.200]	2,54 [.100]	1,27 [.050]	3 _{MAX} [.118]	1,9 [.075]	0,64 [.025]	∅ 2,85 _{MIN} [.112]	∅ 0,75 _{MIN} [.030]

All dimensions are given for information only and are in mm [inch], except as otherwise specified | *in mm: 1mm=0.03937 inch

TOOLING

HDAS
HILINX¹⁰⁰⁵
SMASH
HDB/HSB³
R-VPX
R-SATA

127/HE8

Removal tools

Removal tool pin ZC/ X / YC

1272

- Rear release



Removal tool pin Y

24098

- Front release



Removal tool socket YC/Z/X1 (HE 801 & HE804)

1271

- Rear release



Removal tool socket YC/Z/X1 (HE 807)

24099

- Rear release



Removal tool socket Y/YD

20143

- Rear release



Removal tool socket particular contacts (HE 807)

23550

- Rear release



Insertion tools

Insertion tool pin X

1275

- Insertion on the same side as removal
- Eased contact insertion



Crimping tool pin X

HE 8 20 051

- AWG 26 to 22
- No additional turret



Crimping tool socket X1

809801

- AWG 26 to 22
- Additional turret: 127.800.030
- Military reference: M22520/2-01



All dimensions are given for information only and are in mm [inch], except as otherwise specified | *in mm: 1mm=0.03937 inch

HOW TO ORDER - 127 SERIES

MILITARY PART NUMBER

1.	2.	3.	4.	5.	6.	7.	8.	9.	10.
Series	Number of signal contacts	Fittings	Contact gender	Fitting material	Tail finish	Contact type	Connector type	Number of special contacts	Cavities marking
127	33	A	M	1	4	YC			

1. Series

127	2-row connector (HE801 & HE804)
127H	Hybrid connector (HE807)
127T	3-row connector

2. Number of signal contacts

127H	0	41
	5	60
	17	84
127	29	65
	17	84
	29	72
	41	96
127T	53	
	80	144

3. Fitting

For receptacle (X: no fitting)

Fitting	Keying	Locking
KD/AD/KED/AED/KT/AT/KET/AET	✓	✓
K/A/P/B/KE/EL	✓	X
S/D/SC/DC	X	✓

For plug (XL: no fitting)

A/J/E/R	✓	X
PA/PC/T	X	X
D/S/EF/RF	X	✓
AS/JS/ES/RS/ET/RT	✓	✓

4. Contact gender

F	Female
M	Male

5. Fitting material

Blank	Nickel over brass
1	Passivated stainless steel

6. Tail finish

1	Tin lead on YC/Y/ZC/U/YL/YD & Gold on X/X1
4	Lead free ✓

7. Contact type

YC	Right angle PC tail
Y	Straight PC tail
YD	Straight PC tail (HE804 female only)
Z/ZC	Solder cup
X1/X	Crimp barrel

8. Connector type

Blank	HE804 connector
R	Male HE801 or HE807 connector
N	Female HE801 or HE807 connector

9. Number of special contacts (HE807 only)

3A	Special contacts
6A	
Blank	No special contact
10	Cavities marking
Blank	Standard
B	Reversed marking

10. Cavities marking

Blank	Standard
B	Reversed marking

HOW TO ORDER - HE8 SERIES

COMMERCIAL PART NUMBER

1.	2.	3.	4.	5.	6.	7.	8.
Series	Connector type	Number of contacts	Termination style	Stiffening bar	Special contacts	Fitting	Tail finish
HE 807	EN	17	Y0	A	3	212	3

1. Series

HE801	Signal only
HE804	
HE807	Hybrid (special contacts)

5. Stiffening bar

A	Standard, without stiffening bar
B	With stiffening bar for connector with central fitting only

2. Connector type

FB	
FC	Female plug
FS	
FD	
FP	Male plug
FN	
EN	
EP	Male receptacle
ES	
EB	
	Female receptacle

6. Special contacts

3	HE807 only
6	

7. Fitting

	HE801	HE804	HE807	Keying	Locking	Comment
000				No fitting		
101	✓	✓	✓	✓	X	
102	✓	✓	✓	X	X	
103	✓	✓	✓	X	✓	Plug
110	X	✓	X	✓	X	Nickel over brass fitting
111	X	✓	X	✓	X	
112	X	✓	X	X	✓	
117	✓	✓	X	✓	X	For stainless steel fitting, replace the 1** by a 3** in the designation
118	✓	✓	X	✓	X	
119	✓	✓	X	X	✓	
124	✓	✓	✓	✓	✓	
125	✓	✓	✓	✓	✓	
327	✓	✓	✓	✓	✓	
201	X	✓	X	✓	X	
203	✓	✓	X	✓	X	
208	✓	X	✓	✓	X	
209	X	✓	X	✓	X	
212	✓	X	✓	✓	X	Receptacle
213	X	X	✓	X	✓	Nickel over brass fitting
219	✓	X	X	X	✓	
220	X	✓	X	X	✓	For stainless steel fitting, replace the 2** by a 4** in the designation
221	✓	✓	✓	✓	✓	
223	X	✓	X	✓	✓	
224	✓	X	✓	✓	✓	
226	X	X	✓	✓	X	
228	X	✓	X	✓	X	
422	✓	✓	✓	✓	✓	
425	✓	✓	✓	✓	✓	

3. Number of contacts

0	
5	
17	HE807
29	
41	
60	
84	
17	
29	HE801 & HE804
33	
41	
53	
65	
72	
84	
96	

4. Termination style

Y1	Right angle PC tail
Y0	Straight PC tail
Z1	Solder cup
S11	Crimp barrel
Blank	No signal contacts

8. Tail finish

3	Standard
2	S11 version

✓: RoHS compliant

All dimensions are given for information only and are in mm [inch], except as otherwise specified | *in mm: 1mm=0.03937 inch

CROSS REF - HE8 SERIES - HE801

HE801 connectors with 2 fitting locations (17, 29, 33, 41, 53 and 65 contacts)				
Connectors delivered with fittings		Connectors delivered without fitting + 2 separate fittings to be order separately		
HE801 reference	127 reference	127 reference	and brass fittings	or stainless steel fittings
HE801 FB 17 Y1A 101 3	127 17 A F1YCN	127 17 XL F1YCN	HE8C101	HE8C301
HE801 FP 17 Y1A 101 3	127 17 J M1YCR	127 17 XL M1YCR	HE8C101	HE8C301
HE801 ES 17 Y0A 212 3	127 17 K F1YN	127 17 X F1YN	HE8C212	HE8C412
HE801 ES 17 Z1A 212 3	127 17 K F1ZN	127 17 X F1ZN	HE8C212	HE8C412
HE801 ES 17 S11A 212 2	127 17 K F1X1N	127 17 X F1X1N	HE8C212	HE8C412
HE801 EN 17 Y0A 212 3	127 17 A M1YR	127 17 X F1YR	HE8C212	HE8C412
HE801 EN 17 Z1A 212 3	127 17 A M1ZCR	127 17 X F1ZCR	HE8C212	HE8C412
HE801 ES 17 S11A 000 2	127 17 X F1X1N	127 17 XL F1X1N	NA	NA
HE801 FS 17 S11A 117 2	127 17 E F1X1N	127 17 XL F1X1N	HE8C117	HE8C317
HE801 FS 17 S11A 000 2	127 17 XL F1X1N	127 17 XL F1X1N	NA	NA
HE801 EN 17 Y0A 000 3	127 17 X M1YR	127 17 X M1YR	NA	NA
HE801 FN 17 Y0A 117 3	127 17 R M1YR	127 17 XL M1YR	HE8C117	HE8C317
HE801 FN 17 Y0A 119 3	127 17 RF M1YR	127 17 XL M1YR	HE8C119	HE8C319
HE801 FN 17 Y0A 125 3	127 17 RS M1YR	127 17 XL M1YR	HE8C125	HE8C325
HE801 EN 17 Y0A 203 3	127 17 B M1YR	127 17 X M1YR	HE8C203	HE8C403
HE801 FN 17 Y0A 000 3	127 17 XL M1YR	127 17 XL M1YR	NA	NA
HE801 FB 17 Y1A 000 3	127 17 XL F1YCN	127 17 XL F1YCN	NA	NA
HE801 FB 17 Y1A 102 3	127 17 PA F1YCN	127 17 XL F1YCN	HE8C102	HE8C302
HE801 FB 17 Y1A 103 3	127 17 D F1YCN	127 17 XL F1YCN	HE8C103	HE8C303
HE801 EB 17 Y1A 208 3	127 17 KE F1YCN	127 17 X F1YCN	HE8C208	HE8C408
HE801 EB 17 Y1A 000 3	127 17 X F1YCN	127 17 X F1YCN	NA	NA
HE801 FP 17 Y1A 000 3	127 17 XL M1YCR	127 17 XL M1YCR	NA	NA
HE801 FP 17 Y1A 102 3	127 17 PC M1YCR	127 17 XL M1YCR	HE8C102	HE8C302
HE801 FP 17 Y1A 103 3	127 17 S M1YCR	127 17 XL M1YCR	HE8C103	HE8C303
HE801 EP 17 Y1A 208 3	127 17 AE M1YCR	127 17 X M1YCR	HE8C208	HE8C408
HE801 EP 17 Y1A 000 3	127 17 X M1YCR	127 17 X M1YCR	NA	NA
HE801 ES 17 Y0A 000 3	127 17 X F1YN	127 17 X F1YN	NA	NA
HE801 FS 17 Y0A 117 3	127 17 E F1YN	127 17 XL F1YN	HE8C117	HE8C317
HE801 FS 17 Y0A 119 3	127 17 EF F1YN	127 17 XL F1YN	HE8C119	HE8C319
HE801 FS 17 Y0A 125 3	127 17 ES F1YN	127 17 XL F1YN	HE8C125	HE8C325
HE801 FS 17 Y0A 000 3	127 17 XL F1YN	127 17 XL F1YN	NA	NA
HE801 ES 17 Z1A 000 3	127 17 X F1ZN	127 17 X F1ZN	NA	NA
HE801 FS 17 Z1A 117 3	127 17 E F1ZN	127 17 XL F1ZN	HE8C117	HE8C317
HE801 FS 17 Z1A 119 3	127 17 EF F1ZN	127 17 XL F1ZN	HE8C119	HE8C319
HE801 FS 17 Z1A 125 3	127 17 ES F1ZN	127 17 XL F1ZN	HE8C125	HE8C325
HE801 FS 17 Z1A 000 3	127 17 XL F1ZN	127 17 XL F1ZN	NA	NA
HE801 EN 17 Z1A 000 3	127 17 X M1ZCR	127 17 X M1ZCR	NA	NA
HE801 FN 17 Z1A 117 3	127 17 R M1ZCR	127 17 XL M1ZCR	HE8C117	HE8C317
HE801 FN 17 Z1A 119 3	127 17 RF M1ZCR	127 17 XL M1ZCR	HE8C119	HE8C319
HE801 FN 17 Z1A 125 3	127 17 RS M1ZCR	127 17 XL M1ZCR	HE8C125	HE8C325
HE801 EN 17 Z1A 203 3	127 17 B M1ZCR	127 17 X M1ZCR	HE8C203	HE8C403
HE801 EN 17 Z1A 219 3	127 17 D M1ZCR	127 17 X M1ZCR	HE8C219	HE8C419
HE801 FN 17 Z1A 000 3	127 17 XL M1ZCR	127 17 XL M1ZCR	NA	NA

All dimensions are given for information only and are in mm [inch], except as otherwise specified | *in mm: 1mm=0.03937 inch

CROSS REF - HE8 SERIES - HE801

HDAS
HILINX¹⁰⁰⁵
SMASH
HDB/HSEB¹
R-VPX
R-SATA

HE801 connectors with 3 fitting locations (72, 84 and 96 contacts)						
Connectors delivered with fittings		Connectors delivered without fitting + 3 separate fittings to be order separately				
HE 801 references	127 reference	127 reference	and brass fittings		or stainless steel fittings	
			2 extremity fittings	1 central fitting	2 extremity fittings	1 central fitting
HE801 FB 72 Y1A 101 3	127 72 A F1YCN	127 72 XL F1YCN	HE8C101	HE8C102	HE8C301	HE8C302
HE801 FP 72 Y1A 101 3	127 72 J M1YCR	127 72 XL M1YCR	HE8C101	HE8C102	HE8C301	HE8C302
HE801 ES 72 Y0A 212 3	127 72 K F1YN	127 72 X F1YN	HE8C212	HE8C229	HE8C412	HE8C429
HE801 ES 72 Z1B 212 3	127 72 K F1ZN	127 72 X F1ZN	HE8C212	HE8C229	HE8C412	HE8C429
HE801 FS 72 S11A 212 2	127 72 K F1X1N	127 72 X F1X1N	HE8C212	HE8C229	HE8C412	HE8C429
HE801 EN 72 Y0A 212 3	127 72 A M1YR	127 72 X M1YR	HE8C212	HE8C229	HE8C412	HE8C429
HE801 EN 72 Z1B 212 3	127 72 A M1ZCR	127 72 X M1ZCR	HE8C212	HE8C229	HE8C412	HE8C429
HE801 ES 72 S11B 000 2	127 72 X F1X1N	127 72 X F1X1N	NA	NA	NA	NA
HE801 FS 72 S11B 117 2	127 72 E F1X1N	127 72 XL F1X1N	HE8C117	HE8C129	HE8C317	HE8C329
HE801 FS 72 S11B 000 2	127 72 XL F1X1N	127 72 XL F1X1N	NA	NA	NA	NA
HE801 EN 72 Y0A 000 3	127 72 X M1YR	127 72 X M1YR	NA	NA	NA	NA
HE801 FN 72 Y0A 117 3	127 72 R M1YR	127 72 XL M1YR	HE8C117	HE8C129	HE8C317	HE8C329
HE801 FN 72 Y0A 119 3	127 72 RF M1YR	127 72 XL M1YR	HE8C119	HE8C129	HE8C319	HE8C329
HE801 FN 72 Y0A 125 3	127 72 RS M1YR	127 72 XL M1YR	HE8C125	HE8C129	HE8C325	HE8C329
HE801 EN 72 Y0A 203 3	127 72 B M1YR	127 72 X M1YR	HE8C203	HE8C229	HE8C403	HE8C429
HE801 FN 72 Y0A 000 3	127 72 XL M1YR	127 72 XL M1YR	NA	NA	NA	NA
HE801 FB 72 Y1A 000 3	127 72 XL F1YCN	127 72 XL F1YCN	NA	NA	NA	NA
HE801 FB 72 Y1A 102 3	127 72 PA F1YCN	127 72 XL F1YCN	HE8C102	HE8C102	HE8C302	HE8C302
HE801 FB 72 Y1A 103 3	127 72 D F1YCN	127 72 XL F1YCN	HE8C103	HE8C102	HE8C303	HE8C302
HE801 EB 72 Y1A 208 3	127 72 KE F1YCN	127 72 X F1YCN	HE8C208	HE8C208	HE8C408	HE8C408
HE801 EB 72 Y1A 000 3	127 72 X F1YCN	127 72 X F1YCN	NA	NA	NA	NA
HE801 FP 72 Y1A 000 3	127 72 XL M1YCR	127 72 XL M1YCR	NA	NA	NA	NA
HE801 FP 72 Y1A 102 3	127 72 PC M1YCR	127 72 XL M1YCR	HE8C102	HE8C102	HE8C302	HE8C302
HE801 FP 72 Y1A 103 3	127 72 S M1YCR	127 72 XL M1YCR	HE8C103	HE8C102	HE8C303	HE8C302
HE801 EP 72 Y1A 208 3	127 72 AE M1YCR	127 72 X M1YCR	HE8C208	HE8C208	HE8C408	HE8C408
HE801 EP 72 Y1A 000 3	127 72 X M1YCR	127 72 X M1YCR	NA	NA	NA	NA
HE801 ES 72 Y0A 000 3	127 72 X F1YN	127 72 X F1YN	NA	NA	NA	NA
HE801 FS 72 Y0A 117 3	127 72 E F1YN	127 72 XL F1YN	HE8C117	HE8C129	HE8C317	HE8C329
HE801 FS 72 Y0A 119 3	127 72 EF F1YN	127 72 XL F1YN	HE8C119	HE8C129	HE8C319	HE8C329
HE801 FS 72 Y0A 125 3	127 72 ES F1YN	127 72 XL F1YN	HE8C125	HE8C129	HE8C325	HE8C329
HE801 FS 72 Y0A 000 3	127 72 XL F1YN	127 72 XL F1YN	NA	NA	NA	NA
HE801 ES 72 Z1B 000 3	127 72 X F1ZN	127 72 X F1ZN	NA	NA	NA	NA
HE801 FS 72 Z1B 117 3	127 72 E F1ZN	127 72 XL F1ZN	HE8C117	HE8C129	HE8C317	HE8C329
HE801 FS 72 Z1B 119 3	127 72 EF F1ZN	127 72 XL F1ZN	HE8C119	HE8C129	HE8C319	HE8C329
HE801 FS 72 Z1B 125 3	127 72 ES F1ZN	127 72 XL F1ZN	HE8C125	HE8C129	HE8C325	HE8C329
HE801 FS 72 Z1B 000 3	127 72 XL F1ZN	127 72 XL F1ZN	NA	NA	NA	NA
HE801 EN 72 Z1B 000 3	127 72 X M1ZCR	127 72 X M1ZCR	NA	NA	NA	NA
HE801 FN 72 Z1B 117 3	127 72 R M1ZCR	127 72 XL M1ZCR	HE8C117	HE8C129	HE8C317	HE8C329
HE801 FN 72 Z1B 119 3	127 72 RF M1ZCR	127 72 XL M1ZCR	HE8C119	HE8C129	HE8C319	HE8C329
HE801 FN 72 Z1B 125 3	127 72 RS M1ZCR	127 72 XL M1ZCR	HE8C125	HE8C129	HE8C325	HE8C329
HE801 EN 72 Z1B 203 3	127 72 B M1ZCR	127 72 X M1ZCR	HE8C203	HE8C229	HE8C403	HE8C429
HE801 EN 72 Z1B 219 3	127 72 D M1ZCR	127 72 X M1ZCR	HE8C208	HE8C229	HE8C408	HE8C429
HE801 FN 72 Z1B 000 3	127 72 XL M1ZCR	127 72 XL M1ZCR	NA	NA	NA	NA
HE801 ES 72 Z1A 000 3	127 72 X FA1ZN	127 72 X FA1ZN	NA	NA	NA	NA
HE801 ES 72 Z1A 212 3	127 72 K FA1ZN	127 72 X FA1ZN	HE8C212	HE8C229	HE8C412	HE8C429
HE801 FS 72 Z1A 117 3	127 72 E FA1ZN	127 72 XL FA1ZN	HE8C117	HE8C129	HE8C317	HE8C329
HE801 FS 72 Z1A 000 3	127 72 XL FA1ZN	127 72 XL FA1ZN	NA	NA	NA	NA
HE801 EN 72 Z1A 000 3	127 72 X MA1ZCR	127 72 X MA1ZCR	NA	NA	NA	NA
HE801 EN 72 Z1A 212 3	127 72 A MA1ZCR	127 72 X MA1ZCR	HE8C212	HE8C229	HE8C412	HE8C429
HE801 FN 72 Z1A 000 3	127 72 XL MA1ZCR	127 72 XL MA1ZCR	NA	NA	NA	NA

All dimensions are given for information only and are in mm [inch], except as otherwise specified | *in mm: 1mm=0.03937 inch

CROSS REF - HE8 SERIES - HE804

HE804 connectors with 2 fitting locations (17, 29, 33, 41, 53 and 65 contacts)				
Connectors delivered with fittings		Connectors delivered without fitting + 2 separate fittings to be order separately		
HE804 reference	127 reference	127 reference	and brass fittings	or stainless steel fittings
HE804 ES 17 S11B 000 2	127 17 X F1X1	127 17 X F1X1	NA	NA
HE804 FS 17 S11B 110 2	127 17 E F1X1	127 17 XL F1X1	HE8C110	HE8C310
HE804 FS 17 S11B 112 2	127 17 EF F1X1	127 17 XL F1X1	HE8C112	HE8C312
HE804 FS 17 S11B 125 2	127 17 ES F1X1	127 17 XL F1X1	HE8C125	HE8C325
HE804 ES 17 S11B 201 2	127 17 K F1X1	127 17 X F1X1	HE8C201	HE8C401
HE804 EN 17 S21B 000 2	127 17 X M1X	127 17 X M1X	NA	NA
HE804 FN 17 S21B 110 2	127 17 R M1X	127 17 XL M1X	HE8C110	HE8C310
HE804 FN 17 S21B 112 2	127 17 RF M1X	127 17 XL M1X	HE8C112	HE8C312
HE804 FN 17 S21B 125 2	127 17 RS M1X	127 17 XL M1X	HE8C125	HE8C325
HE804 EN 17 S21B 201 2	127 17 A M1X	127 17 X M1X	HE8C201	HE8C401
HE804 EN 17 S21B 203 2	127 17 B M1X	127 17 X M1X	HE8C203	HE8C403
HE804 EN 17 S21B 220 2	127 17 D M1X	127 17 X M1X	HE8C220	HE8C420
HE804 EN 17 Y0A 000 3	127 17 X M1Y	127 17 X M1Y	NA	NA
HE804 FN 17 Y0A 110 3	127 17 R M1Y	127 17 XL M1Y	HE8C110	HE8C310
HE804 FN 17 Y0A 112 3	127 17 RF M1Y	127 17 XL M1Y	HE8C112	HE8C312
HE804 FN 17 Y0A 125 3	127 17 RS M1Y	127 17 XL M1Y	HE8C125	HE8C325
HE804 EN 17 Y0A 201 3	127 17 A M1Y	127 17 X M1Y	HE8C201	HE8C401
HE804 EN 17 Y0A 203 3	127 17 B M1Y	127 17 X M1Y	HE8C203	HE8C403
HE804 FB 17 Y1A 000 3	127 17 XL F1YC	127 17 XL F1YC	NA	NA
HE804 FB 17 Y1A 101 3	127 17 A F1YC	127 17 XL F1YC	HE8C101	HE8C301
HE804 FB 17 Y1A 102 3	127 17 PA F1YC	127 17 XL F1YC	HE8C102	HE8C302
HE804 FB 17 Y1A 103 3	127 17 D F1YC	127 17 XL F1YC	HE8C103	HE8C303
HE804 EB 17 Y1A 209 3	127 17 KE F1YC	127 17 X F1YC	HE8C209	HE8C409
HE804 FP 17 Y1A 000 3	127 17 XL M1YC	127 17 XL M1YC	NA	NA
HE804 FP 17 Y1A 101 3	127 17 J M1YC	127 17 XL M1YC	HE8C101	HE8C301
HE804 FP 17 Y1A 102 3	127 17 PC M1YC	127 17 XL M1YC	HE8C102	HE8C302
HE804 FP 17 Y1A 103 3	127 17 S M1YC	127 17 XL M1YC	HE8C103	HE8C303
HE804 EP 17 Y1A 209 3	127 17 AE M1YC	127 17 X M1YC	HE8C209	HE8C409
HE804 ES 17 Y0A 000 3	127 17 X F1YD	127 17 X F1YD	NA	NA
HE804 FS 17 Y0A 110 3	127 17 E F1YD	127 17 XL F1YD	HE8C110	HE8C310
HE804 FS 17 Y0A 112 3	127 17 EF F1YD	127 17 XL F1YD	HE8C112	HE8C312
HE804 FS 17 Y0A 125 3	127 17 ES F1YD	127 17 XL F1YD	HE8C125	HE8C325
HE804 ES 17 Y0A 201 3	127 17 K F1YD	127 17 X F1YD	HE8C201	HE8C401
HE804 ES 17 Z1A 000 3	127 17 X F1Z	127 17 X F1Z	NA	NA
HE804 FS 17 Z1A 110 3	127 17 E F1Z	127 17 XL F1Z	HE8C110	HE8C310
HE804 FS 17 Z1A 112 3	127 17 EF F1Z	127 17 XL F1Z	HE8C112	HE8C312
HE804 FS 17 Z1A 125 3	127 17 ES F1Z	127 17 XL F1Z	HE8C125	HE8C325
HE804 ES 17 Z1A 201 3	127 17 K F1Z	127 17 X F1Z	HE8C201	HE8C401
HE804 EN 17 Z1A 000 3	127 17 X M1ZC	127 17 X M1ZC	NA	NA
HE804 FN 17 Z1A 110 3	127 17 R M1ZC	127 17 XL M1ZC	HE8C110	HE8C310
HE804 FN 17 Z1A 112 3	127 17 RF M1ZC	127 17 XL M1ZC	HE8C112	HE8C312
HE804 FN 17 Z1A 125 3	127 17 RS M1ZC	127 17 XL M1ZC	HE8C125	HE8C325
HE804 EN 17 Z1A 201 3	127 17 A M1ZC	127 17 X M1ZC	HE8C201	HE8C401
HE804 EN 17 Z1A 203 3	127 17 B M1ZC	127 17 X M1ZC	HE8C203	HE8C403
HE804 EN 17 Z1A 220 3	127 17 D M1ZC	127 17 X M1ZC	HE8C220	HE8C420

All dimensions are given for information only and are in mm [inch], except as otherwise specified | *in mm: 1mm=0.03937 inch

CROSS REF - HE8 SERIES - HE804

HDAS
HILINX¹⁰⁰⁵
SMASH
HDB/HSEB¹
R-VPX
R-SATA

127/HE8

HE804 connectors with 3 fitting locations (72, 84 and 96 contacts)						
Connectors delivered with fittings		Connectors delivered without fitting + 3 separate fittings to be order separately				
HE 804 references	127 reference	127 reference	and brass fittings		or stainless steel fittings	
			2 extremity fittings	1 central fitting	2 extremity fittings	1 central fitting
HE804 ES 72 S11A 000 2	127 72 X F1X1	127 72 X F1X1	NA	NA	NA	NA
HE804 FS 72 S11A 110 2	127 72 E F1X1	127 72 XL F1X1	HE8C110	HE8C113	HE8C310	HE8C313
HE804 FS 72 S11A 112 2	127 72 EF F1X1	127 72 XL F1X1	HE8C112	HE8C113	HE8C312	HE8C313
HE804 FS 72 S11A 125 2	127 72 ES F1X1	127 72 XL F1X1	HE8C125	HE8C113	HE8C325	HE8C313
HE804 ES 72 S11A 201 2	127 72 K F1X1	127 72 X F1X1	HE8C201	HE8C202	HE8C401	HE8C402
HE804 EN 72 S21A 000 2	127 72 X M1X	127 72 X M1X	NA	NA	NA	NA
HE804 FN 72 S21A 110 2	127 72 R M1X	127 72 XL M1X	HE8C110	HE8C113	HE8C310	HE8C313
HE804 FN 72 S21A 112 2	127 72 RF M1X	127 72 XL M1X	HE8C112	HE8C113	HE8C312	HE8C313
HE804 FN 72 S21A 125 2	127 72 RS M1X	127 72 XL M1X	HE8C125	HE8C113	HE8C325	HE8C313
HE804 EN 72 S21A 201 2	127 72 A M1X	127 72 X M1X	HE8C201	HE8C202	HE8C401	HE8C402
HE804 EN 72 S21A 203 2	127 72 B M1X	127 72 X M1X	HE8C203	HE8C202	HE8C403	HE8C402
HE804 EN 72 S21A 220 2	127 72 D M1X	127 72 X M1X	HE8C220	HE8C202	HE8C420	HE8C402
HE804 EN 72 Y0A 000 3	127 72 X M1Y	127 72 X M1Y	NA	NA	NA	NA
HE804 FN 72 Y0A 110 3	127 72 R M1Y	127 72 XL M1Y	HE8C110	HE8C113	HE8C310	HE8C313
HE804 FN 72 Y0A 112 3	127 72 RF M1Y	127 72 XL M1Y	HE8C112	HE8C113	HE8C312	HE8C313
HE804 FN 72 Y0A 125 3	127 72 RS M1Y	127 72 XL M1Y	HE8C125	HE8C113	HE8C325	HE8C313
HE804 EN 72 Y0A 201 3	127 72 A M1Y	127 72 X M1Y	HE8C201	HE8C202	HE8C401	HE8C402
HE804 EN 72 Y0A 203 3	127 72 B M1Y	127 72 X M1Y	HE8C203	HE8C202	HE8C403	HE8C402
HE804 FB 72 Y1A 000 3	127 72 XL F1YC	127 72 XL F1YC	NA	NA	NA	NA
HE804 FB 72 Y1A 101 3	127 72 A F1YC	127 72 XL F1YC	HE8C101	HE8C102	HE8C301	HE8C302
HE804 FB 72 Y1A 102 3	127 72 PA F1YC	127 72 XL F1YC	HE8C102	HE8C102	HE8C302	HE8C302
HE804 FB 72 Y1A 103 3	127 72 D F1YC	127 72 XL F1YC	HE8C103	HE8C102	HE8C303	HE8C302
HE804 EB 72 Y1A 209 3	127 72 KE F1YC	127 72 X F1YC	HE8C209	HE8C209	HE8C409	HE8C409
HE804 FP 72 Y1A 000 3	127 72 XL M1YC	127 72 XL M1YC	NA	NA	NA	NA
HE804 FP 72 Y1A 101 3	127 72 J M1YC	127 72 XL M1YC	HE8C101	HE8C102	HE8C301	HE8C302
HE804 FP 72 Y1A 102 3	127 72 PC M1YC	127 72 XL M1YC	HE8C102	HE8C102	HE8C302	HE8C302
HE804 FP 72 Y1A 103 3	127 72 S M1YC	127 72 XL M1YC	HE8C103	HE8C102	HE8C303	HE8C302
HE804 EP 72 Y1A 209 3	127 72 AE M1YC	127 72 X M1YC	HE8C209	HE8C209	HE8C409	HE8C409
HE804 ES 72 Y0A 000 3	127 72 X F1YD	127 72 X F1YD	NA	NA	NA	NA
HE804 FS 72 Y0A 110 3	127 72 E F1YD	127 72 XL F1YD	HE8C110	HE8C113	HE8C310	HE8C313
HE804 FS 72 Y0A 112 3	127 72 F F1YD	127 72 XL F1YD	HE8C112	HE8C113	HE8C312	HE8C313
HE804 FS 72 Y0A 125 3	127 72 ES F1YD	127 72 XL F1YD	HE8C125	HE8C113	HE8C325	HE8C313
HE804 ES 72 Y0A 201 3	127 72 K F1YD	127 72 X F1YD	HE8C201	HE8C202	HE8C401	HE8C402
HE804 ES 72 Z1B 000 3	127 72 X F1Z	127 72 X F1Z	NA	NA	NA	NA
HE804 FS 72 Z1B 110 3	127 72 E F1Z	127 72 XL F1Z	HE8C110	HE8C113	HE8C310	HE8C313
HE804 FS 72 Z1B 112 3	127 72 EF F1Z	127 72 XL F1Z	HE8C112	HE8C113	HE8C312	HE8C313
HE804 FS 72 Z1B 125 3	127 72 ES F1Z	127 72 XL F1Z	HE8C125	HE8C113	HE8C325	HE8C313
HE804 ES 72 Z1B 201 3	127 72 K F1Z	127 72 X F1Z	HE8C201	HE8C202	HE8C401	HE8C402
HE804 EN 72 Z1B 000 3	127 72 X M1ZC	127 72 X M1ZC	NA	NA	NA	NA
HE804 FN 72 Z1B 110 3	127 72 R M1ZC	127 72 XL M1ZC	HE8C110	HE8C113	HE8C310	HE8C313
HE804 FN 72 Z1B 112 3	127 72 RF M1ZC	127 72 XL M1ZC	HE8C112	HE8C113	HE8C312	HE8C313
HE804 FN 72 Z1B 125 3	127 72 RS M1ZC	127 72 XL M1ZC	HE8C125	HE8C113	HE8C325	HE8C313
HE804 EN 72 Z1B 201 3	127 72 A M1ZC	127 72 X M1ZC	HE8C201	HE8C202	HE8C401	HE8C402
HE804 EN 72 Z1B 203 3	127 72 B M1ZC	127 72 X M1ZC	HE8C203	HE8C202	HE8C403	HE8C402
HE804 EN 72 Z1B 220 3	127 72 D M1ZC	127 72 X M1ZC	HE8C220	HE8C202	HE8C420	HE8C402
HE804 ES 72 Z1A 000 3	127 72 X FA1Z	127 72 X FA1Z	NA	NA	NA	NA
HE804 FS 72 Z1A 110 3	127 72 E FA1Z	127 72 XL FA1Z	HE8C110	HE8C113	HE8C310	HE8C313
HE804 FS 72 Z1A 112 3	127 72 F FA1Z	127 72 XL FA1Z	HE8C112	HE8C113	HE8C312	HE8C313
HE804 FS 72 Z1A 125 3	127 72 ES FA1Z	127 72 XL FA1Z	HE8C125	HE8C113	HE8C325	HE8C313
HE804 ES 72 Z1A 201 3	127 72 K FA1Z	127 72 X FA1Z	HE8C201	HE8C202	HE8C401	HE8C402
HE804 EN 72 Z1A 000 3	127 72 X MA1ZC	127 72 X MA1ZC	NA	NA	NA	NA
HE804 FN 72 Z1A 110 3	127 72 R MA1ZC	127 72 XL MA1ZC	HE8C110	HE8C113	HE8C310	HE8C313
HE804 FN 72 Z1A 112 3	127 72 RF MA1ZC	127 72 XL MA1ZC	HE8C112	HE8C113	HE8C312	HE8C313
HE804 FN 72 Z1A 125 3	127 72 RS MA1ZC	127 72 XL MA1ZC	HE8C125	HE8C113	HE8C325	HE8C313
HE804 EN 72 Z1A 201 3	127 72 A MA1ZC	127 72 X MA1ZC	HE8C201	HE8C202	HE8C401	HE8C402
HE804 EN 72 Z1A 203 3	127 72 B MA1ZC	127 72 X MA1ZC	HE8C203	HE8C202	HE8C403	HE8C402
HE804 EN 72 Z1A 220 3	127 72 D MA1ZC	127 72 X MA1ZC	HE8C220	HE8C202	HE8C420	HE8C402

All dimensions are given for information only and are in mm [inch], except as otherwise specified | *in mm: 1mm=0.03937 inch

CROSS REF - HE8 SERIES - HE807

HE807 connectors with 2 fitting locations				
Connectors delivered with fittings		Connectors delivered without fitting + 2 separate fittings to be order separately		
HE807 reference	127 reference	127 reference	and brass fittings	or stainless steel fittings
Asymetrical arrangements 				
HE807 FB 17 Y1A 3 000 3	127H 17 XL F1YCN 3A	127H 17 XL F1YCN 3A	NA	NA
HE807 FB 17 Y1A 3 101 3	127H 17 A F1YCN 3A	127H 17 XL F1YCN 3A	HE8C101	HE8C301
HE807 FB 17 Y1A 3 102 3	127H 17 PA F1YCN 3A	127H 17 XL F1YCN 3A	HE8C102	HE8C302
HE807 FB 17 Y1A 3 103 3	127H 17 D F1YCN 3A	127H 17 XL F1YCN 3A	HE8C103	HE8C303
HE807 FB 17 Y1A 3 206 3	127H 17 IE F1YCN 3AB	127H 17 XL F1YCN 3A	HE8C206	HE8C406
HE807 FB 17 Y1A 3 208 3	127H 17 KE F1YCN 3AB	127H 17 XL F1YCN 3A	HE8C208	HE8C408
HE807 EP 17 Y1A 3 000 3	127H 17 X M1YCR 3A	127H 17 X M1YCR 3A	NA	NA
HE807 EP 17 Y1A 3 101 3	127H 17 A M1YCR 3AB	127H 17 X M1YCR 3A	HE8C101	HE8C301
HE807 EP 17 Y1A 3 102 3	127H 17 PA M1YCR 3AB	127H 17 X M1YCR 3A	HE8C102	HE8C302
HE807 EP 17 Y1A 3 103 3	127H 17 D M1YCR 3AB	127H 17 X M1YCR 3A	HE8C103	HE8C303
HE807 EP 17 Y1A 3 206 3	127H 17 IE M1YCR 3A	127H 17 X M1YCR 3A	HE8C206	HE8C406
HE807 EP 17 Y1A 3 208 3	127H 17 KE M1YCR 3A	127H 17 X M1YCR 3A	HE8C208	HE8C408
HE807 EN 17 Y0A 3 000 3	127H 17 X M1YR 3A	127H 17 X M1YR 3A	NA	NA
HE807 EN 17 Y0A 3 212 3	127H 17 K M1YR 3A	127H 17 X M1YR 3A	HE8C212	HE8C412
HE807 EN 17 Y0A 3 213 3	127H 17 S M1YR 3A	127H 17 X M1YR 3A	HE8C213	HE8C413
HE807 EN 17 Y0A 3 117 3	127H 17 E M1YR 3AB	127H 17 X M1YR 3A	HE8C117	HE8C317
HE807 FS 17 Y0A 3 000 3	127H 17 XL F1YN 3A	127H 17 XL F1YN 3A	NA	NA
HE807 FS 17 Y0A 3 117 3	127H 17 E F1YN 3A	127H 17 XL F1YN 3A	HE8C117	HE8C317
HE807 FS 17 Y0A 3 212 3	127H 17 K F1YN 3AB	127H 17 XL F1YN 3A	HE8C212	HE8C412
HE807 FS 17 Y0A 3 213 3	127H 17 S F1YN 3AB	127H 17 XL F1YN 3A	HE8C213	HE8C413
HE807 EN 17 Z1A 3 000 3	127H 17 X M1ZCR 3A	127H 17 X M1ZCR 3A	NA	NA
HE807 EN 17 Z1A 3 212 3	127H 17 K M1ZCR 3A	127H 17 X M1ZCR 3A	HE8C212	HE8C412
HE807 EN 17 Z1A 3 213 3	127H 17 S M1ZCR 3A	127H 17 X M1ZCR 3A	HE8C213	HE8C413
HE807 EN 17 Z1A 3 117 3	127H 17 E M1ZCR 3AB	127H 17 X M1ZCR 3A	HE8C117	HE8C317
HE807 FS 17 Z1A 3 000 3	127H 17 XL F1ZN 3A	127H 17 XL F1ZN 3A	NA	NA
HE807 FS 17 Z1A 3 117 3	127H 17 E F1ZN 3A	127H 17 XL F1ZN 3A	HE8C117	HE8C417
HE807 FS 17 Z1A 3 212 3	127H 17 K F1ZN 3AB	127H 17 XL F1ZN 3A	HE8C212	HE8C412
HE807 FS 17 Z1A 3 213 3	127H 17 S F1ZN 3AB	127H 17 XL F1ZN 3A	HE8C213	HE8C413
Symetrical arrangements 				
HE807 FB 17 Y1A 6 000 3	127H 17 XL F1YCN 6A	127H 17 XL F1YCN 6A	NA	NA
HE807 FB 17 Y1A 6 101 3	127H 17 A F1YCN 6A	127H 17 XL F1YCN 6A	HE8C101	HE8C301
HE807 FB 17 Y1A 6 102 3	127H 17 PA F1YCN 6A	127H 17 XL F1YCN 6A	HE8C102	HE8C302
HE807 FB 17 Y1A 6 103 3	127H 17 D F1YCN 6A	127H 17 XL F1YCN 6A	HE8C103	HE8C303
HE807 EB 17 Y1A 6 206 3	127H 17 IE F1YCN 6A	127H 17 X F1YCN 6A	HE8C206	HE8C406
HE807 EB 17 Y1A 6 208 3	127H 17 KE F1YCN 6A	127H 17 X F1YCN 6A	HE8C208	HE8C408
HE807 EB 17 Y1A 6 000 3	127H 17 X F1YCN 6A	127H 17 X F1YCN 6A	NA	NA
HE807 FP 17 Y1A 6 101 3	127H 17 A M1YCR 6A	127H 17 XL M1YCR 6A	HE8C101	HE8C301
HE807 FP 17 Y1A 6 000 3	127H 17 XL M1YCR 6A	127H 17 XL M1YCR 6A	NA	NA
HE807 EP 17 Y1A 6 208 3	127H 17 KE M1YCR 6A	127H 17 X M1YCR 6A	HE8C208	HE8C408
HE807 ES 17 Y0A 6 000 3	127H 17 X F1YN 6A	127H 17 X F1YN 6A	NA	NA
HE807 FS 17 Y0A 6 117 3	127H 17 E F1YN 6A	127H 17 XL F1YN 6A	HE8C117	HE8C317
HE807 FS 17 Y0A 6 000 3	127H 17 XL F1YN 6A	127H 17 XL F1YN 6A	NA	NA
HE807 FS 17 Y0A 6 119 3	127H 17 EF F1YN 6A	127H 17 XL F1YN 6A	HE8C119	HE8C319
HE807 ES 17 Y0A 6 212 3	127H 17 K F1YN 6A	127H 17 X F1YN 6A	HE8C212	HE8C412
HE807 EN 17 Y0A 6 000 3	127H 17 X M1YR 6A	127H 17 X M1YR 6A	NA	NA
HE807 FN 17 Y0A 6 117 3	127H 17 E M1YR 6A	127H 17 XL M1YR 6A	HE8C117	HE8C317
HE807 FN 17 Y0A 6 000 3	127H 17 XL M1YR 6A	127H 17 XL M1YR 6A	NA	NA
HE807 EN 17 Y0A 6 212 3	127H 17 K M1YR 6A	127H 17 X M1YR 6A	HE8C212	HE8C412
HE807 ES 17 Z1A 6 000 3	127H 17 X F1ZN 6A	127H 17 X F1ZN 6A	NA	NA
HE807 FS 17 Z1A 6 117 3	127H 17 E F1ZN 6A	127H 17 XL F1ZN 6A	HE8C117	HE8C317
HE807 FS 17 Z1A 6 000 3	127H 17 XL F1ZN 6A	127H 17 XL F1ZN 6A	NA	NA
HE807 ES 17 Z1A 6 212 3	127H 17 K F1ZN 6A	127H 17 X F1ZN 6A	HE8C212	HE8C412
HE807 ES 17 Z1A 6 213 3	127H 17 S F1ZN 6A	127H 17 X F1ZN 6A	HE8C213	HE8C413
HE807 EN 17 Z1A 6 000 3	127H 17 X M1ZCR 6A	127H 17 X M1ZCR 6A	NA	NA
HE807 FN 17 Z1A 6 117 3	127H 17 E M1ZCR 6A	127H 17 XL M1ZCR 6A	HE8C117	HE8C317
HE807 FN 17 Z1A 6 000 3	127H 17 XL M1ZCR 6A	127H 17 XL M1ZCR 6A	NA	NA
HE807 EN 17 Z1A 6 212 3	127H 17 K M1ZCR 6A	127H 17 X M1ZCR 6A	HE8C212	HE8C412
HE807 EN 17 Z1A 6 213 3	127H 17 S M1ZCR 6A	127H 17 X M1ZCR 6A	HE8C213	HE8C413
ES 17-29-41 ONLY ON S1				
HE807 ES 17 S11A 6 000 2	127H 17 X F1X1N 6A	127H 17 X F1X1N 6A	NA	NA
HE807 FS 17 S11A 6 117 2	127H 17 E F1X1N 6A	127H 17 XL F1X1N 6A	HE8C117	HE8C317
HE807 FS 17 S11A 6 000 2	127H 17 XL F1X1N 6A	127H 17 XL F1X1N 6A	NA	NA
HE807 ES 17 S11A 6 212 2	127H 17 K F1X1N 6A	127H 17 X F1X1N 6A	HE8C212	HE8C412
HE807 ES 17 S11A 6 213 2	127H 17 S F1X1N 6A	127H 17 X F1X1N 6A	HE8C213	HE8C413

All dimensions are given for information only and are in mm [inch], except as otherwise specified | *in mm: 1mm=0.03937 inch

HDAS
HILINX®
SMASH
HDB/HSB®
R-VPX
R-SATA
127/HE8

CROSS REF - HE8 SERIES - HE807

HDAS
HILINX¹⁰⁰⁵
SMASH
HDB/HSB³
R-VPX
R-SATA

HE807 connectors with 3 fitting locations						
Connectors delivered without fitting + 3 separate fittings to be order separately						
HE 804 references	127 reference	127 reference	and brass fittings		or stainless steel fittings	
			2 extremity fittings	1 central fitting	2 extremity fittings	1 central fitting
Asymetrical arrangements						
HE807 FB 84 Y1A 3 000 3	127H 84 XL F1YCN 3A	127H 84 XL F1YCN 3A	NA	NA	NA	NA
HE807 FB 84 Y1A 3 101 3	127H 84 A F1YCN 3A	127H 84 XL F1YCN 3A	HE8C101	HE8C102	HE8C301	HE8C302
HE807 FB 84 Y1A 3 102 3	127H 84 PA F1YCN 3A	127H 84 XL F1YCN 3A	HE8C102	HE8C102	HE8C302	HE8C302
HE807 FB 84 Y1A 3 103 3	127H 84 D F1YCN 3A	127H 84 XL F1YCN 3A	HE8C103	HE8C102	HE8C303	HE8C302
HE807 FB 84 Y1A 3 206 3	127H 84 IE F1YCN 3AB	127H 84 XL F1YCN 3AB	HE8C206	HE8C206	HE8C406	HE8C406
HE807 FB 84 Y1A 3 208 3	127H 84 KE F1YCN 3AB	127H 84 XL F1YCN 3AB	HE8C208	HE8C208	HE8C408	HE8C408
HE807 EP 84 Y1A 3 000 3	127H 84 X M1YCR 3A	127H 84 X M1YCR 3A	NA	NA	NA	NA
HE807 EP 84 Y1A 3 101 3	127H 84 A M1YCR 3AB	127H 84 X M1YCR 3A	HE8C101	HE8C102	HE8C301	HE8C302
HE807 EN 84 Y0A 3 000 3	127H 84 X M1YR 3A	127H 84 X M1YR 3A	NA	NA	NA	NA
HE807 EN 84 Y0A 3 212 3	127H 84 K M1YR 3A	127H 84 X M1YR 3A	HE8C212	HE8C229	HE8C412	HE8C429
HE807 EN 84 Y0A 3 117 3	127H 84 E M1YR 3AB	127H 84 X M1YR 3A	HE8C117	HE8C129	HE8C317	HE8C329
HE807 FS 84 Y0A 3 000 3	127H 84 XL F1YN 3A	127H 84 XL F1YN 3A	NA	NA	NA	NA
HE807 FS 84 Y0A 3 212 3	127H 84 K F1YN 3AB	127H 84 XL F1YN 3A	HE8C212	HE8C229	HE8C412	HE8C429
HE807 EN 84 Z1B 3 000 3	127H 84 X M1ZCR 3A	127H 84 X M1ZCR 3A	NA	NA	NA	NA
HE807 EN 84 Z1B 3 212 3	127H 84 K M1ZCR 3A	127H 84 X M1ZCR 3A	HE8C212	HE8C229	HE8C412	HE8C429
HE807 EN 84 Z1B 3 119 3	127H 84 EF M1ZCR 3AB	127H 84 X M1ZCR 3A	HE8C119	HE8C129	HE8C319	HE8C329
HE807 FS 84 Z1B 3 000 3	127H 84 XL F1ZN 3A	127H 84 XL F1ZN 3A	NA	NA	NA	NA
HE807 FS 84 Z1B 3 212 3	127H 84 K F1ZN 3AB	127H 84 XL F1ZN 3A	HE8C212	HE8C229	HE8C412	HE8C429
Symetrical arrangements						
72 + 6A ONLY ON S1						
HE807 ES 72 S11A 6 000 2	127H 72 X F1X1N 6A	127H 72 X F1X1N 6A				
HE807 FS 72 S11A 6 000 2	127H 72 XL F1X1N 6A	127H 72 XL F1X1N 6A				

All dimensions are given for information only and are in mm [inch], except as otherwise specified | *in mm: 1mm=0.03937 inch

Данный компонент на территории Российской Федерации

Вы можете приобрести в компании MosChip.

Для оперативного оформления запроса Вам необходимо перейти по данной ссылке:

<http://moschip.ru/get-element>

Вы можете разместить у нас заказ для любого Вашего проекта, будь то серийное производство или разработка единичного прибора.

В нашем ассортименте представлены ведущие мировые производители активных и пассивных электронных компонентов.

Нашей специализацией является поставка электронной компонентной базы двойного назначения, продукции таких производителей как XILINX, Intel (ex.ALTERA), Vicor, Microchip, Texas Instruments, Analog Devices, Mini-Circuits, Amphenol, Glenair.

Сотрудничество с глобальными дистрибьюторами электронных компонентов, предоставляет возможность заказывать и получать с международных складов практически любой перечень компонентов в оптимальные для Вас сроки.

На всех этапах разработки и производства наши партнеры могут получить квалифицированную поддержку опытных инженеров.

Система менеджмента качества компании отвечает требованиям в соответствии с ГОСТ Р ИСО 9001, ГОСТ РВ 0015-002 и ЭС РД 009

Офис по работе с юридическими лицами:

105318, г.Москва, ул.Щербаковская д.3, офис 1107, 1118, ДЦ «Щербаковский»

Телефон: +7 495 668-12-70 (многоканальный)

Факс: +7 495 668-12-70 (доб.304)

E-mail: info@moschip.ru

Skype отдела продаж:

moschip.ru

moschip.ru_4

moschip.ru_6

moschip.ru_9