

Silicon PIN Diode

- High voltage current controlled RF resistor for RF attenuator and switches
- Frequency range above 1 MHz up to 6 GHz
- Very low capacitance at zero volt reverse bias at frequencies above 1 GHz (typ. 0.17 pF)
- Low forward resistance (typ. 2.1 Ω @ 10 mA)
- Very low signal distortion
- Pb-free (RoHS compliant) package
- Qualified according AEC Q101¹⁾



BAR64-02EL
BAR64-02V
BAR64-03W

BAR64-04
BAR64-04W

BAR64-05
BAR64-05W

BAR64-06
BAR64-06W

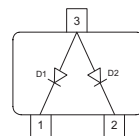
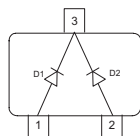
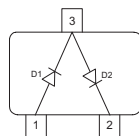
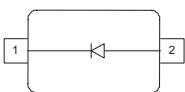

| Type | Package | Configuration | L_S (nH) | Marking |
|-------------|-----------|------------------|------------|---------|
| BAR64-02EL* | TSLP-2-19 | single, leadless | 0.4 | OE |
| BAR64-02V | SC79 | single | 0.6 | O |
| BAR64-03W | SOD323 | single | 1.8 | blue 2 |
| BAR64-04 | SOT23 | series | 1.8 | PPs |
| BAR64-04W | SOT323 | series | 1.4 | PPs |
| BAR64-05 | SOT23 | common cathode | 1.8 | PRs |
| BAR64-05W | SOT323 | common cathode | 1.4 | PRs |
| BAR64-06 | SOT23 | common anode | 1.8 | PSs |
| BAR64-06W | SOT323 | common anode | 1.4 | PSs |

¹⁾BAR64-02EL is not qualified according AEC Q101

Maximum Ratings at $T_A = 25^\circ\text{C}$, unless otherwise specified

| Parameter | Symbol | Value | Unit |
|--|------------------|---------------------------------|------|
| Diode reverse voltage | V_R | 150 | V |
| Forward current | I_F | 100 | mA |
| Total power dissipation BAR64-02EL, $T_S \leq 135^\circ\text{C}$ BAR64-02V, $T_S \leq 125^\circ\text{C}$ BAR64-03W, $T_S \leq 25^\circ\text{C}$ BAR64-04, -05, -06, $T_S \leq 65^\circ\text{C}$ BAR64-04W, -05W, -06W, $T_S \leq 115^\circ\text{C}$ | P_{tot} | 250 250 250 250 250 | mW |
| Junction temperature | T_j | 150 | °C |
| Operating temperature range | T_{op} | -55 ... 125 | |
| Storage temperature | T_{stg} | -55 ... 150 | |

Thermal Resistance

| Parameter | Symbol | Value | Unit |
|--|-------------------|---|------|
| Junction - soldering point ¹⁾ BAR64-02EL BAR64-02V, -04W, -05W, -06W BAR64-03W BAR64-04, -05, -06 | R_{thJS} | ≤ 60 ≤ 140 ≤ 370 ≤ 340 | K/W |

¹⁾For calculation of R_{thJA} please refer to Application Note AN077 (Thermal Resistance Calculation)

Electrical Characteristics at $T_A = 25^\circ\text{C}$, unless otherwise specified

| Parameter | Symbol | Values | | | Unit |
|--|-------------------|--------|------|------|------|
| | | min. | typ. | max. | |
| Breakdown voltage $I_{(\text{BR})} = 5 \mu\text{A}$ | $V_{(\text{BR})}$ | 150 | - | - | V |
| Forward voltage $I_F = 50 \text{ mA}$ | V_F | - | - | 1.1 | |

DC Characteristics

Electrical Characteristics at $T_A = 25^\circ\text{C}$, unless otherwise specified

| Parameter | Symbol | Values | | | Unit |
|---|-------------|------------------|-----------------------------|---------------------|---------------|
| | | min. | typ. | max. | |
| AC Characteristics | | | | | |
| Diode capacitance $V_R = 20\text{ V}, f = 1\text{ MHz}$ $V_R = 0\text{ V}, f = 100\text{ MHz}$ $V_R = 0\text{ V}, f = 1\dots 1.8\text{ GHz}, \text{BAR64-02EL}$ $V_R = 0\text{ V}, f = 1\dots 1.8\text{ GHz}, \text{all other}$ | C_T | - - - - | 0.23 0.3 0.13 0.17 | 0.35 - - - | pF |
| Reverse parallel resistance $V_R = 0\text{ V}, f = 100\text{ MHz}$ $V_R = 0\text{ V}, f = 1\text{ GHz}$ $V_R = 0\text{ V}, f = 1.8\text{ GHz}$ | R_P | - - - | 10 4 3 | - - - | k Ω |
| Forward resistance $I_F = 1\text{ mA}, f = 100\text{ MHz}$ $I_F = 10\text{ mA}, f = 100\text{ MHz}$ $I_F = 100\text{ mA}, f = 100\text{ MHz}$ | r_f | - - - | 12.5 2.1 0.85 | 20 2.8 1.35 | Ω |
| Charge carrier life time $I_F = 10\text{ mA}, I_R = 6\text{ mA}, \text{measured at } I_R = 3\text{ mA},$ $R_L = 100\ \Omega$ | τ_{rr} | - | 1550 | - | ns |
| I-region width | W_I | - | 50 | - | μm |
| Insertion loss ¹⁾ $I_F = 3\text{ mA}, f = 1.8\text{ GHz}$ $I_F = 5\text{ mA}, f = 1.8\text{ GHz}$ $I_F = 10\text{ mA}, f = 1.8\text{ GHz}$ | I_L | - - - | 0.32 0.23 0.16 | - - - | dB |
| Isolation ¹⁾ $V_R = 0\text{ V}, f = 0.9\text{ GHz}$ $V_R = 0\text{ V}, f = 1.8\text{ GHz}$ $V_R = 0\text{ V}, f = 2.45\text{ GHz}$ $V_R = 0\text{ V}, f = 5.6\text{ GHz}$ | I_{SO} | - - - - | 22 17 14.5 8.5 | - - - - | |

¹BAR64-02EL in series configuration, $Z = 50\ \Omega$

Diode capacitance $C_T = f(V_R)$

$f =$ Parameter

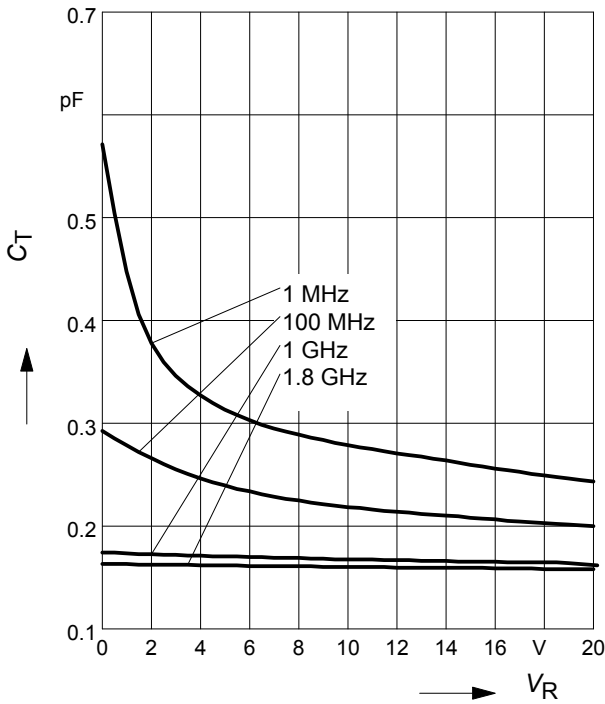

Reverse parallel resistance $R_p = f(V_R)$

$f =$ Parameter

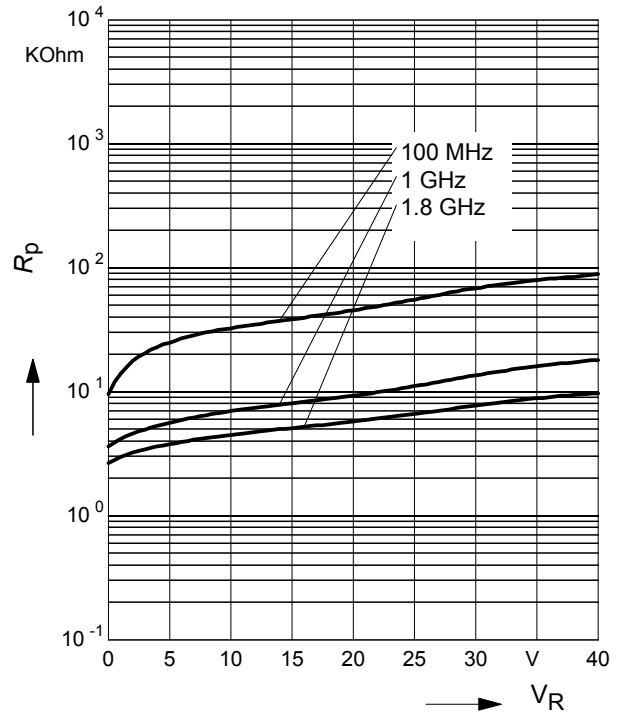

Forward resistance $r_f = f(I_F)$

$f = 100\text{MHz}$

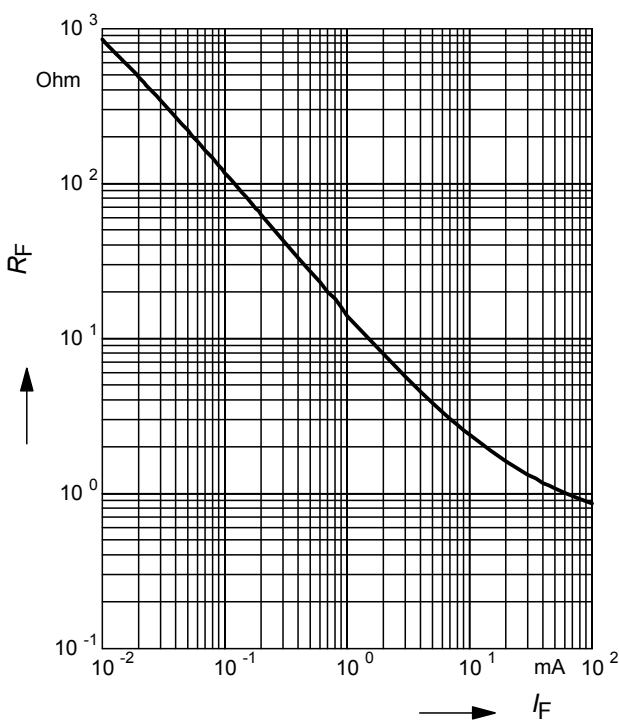

Forward current $I_F = f(V_F)$

$T_A =$ Parameter



Intermodulation intercept point

$IP_3 = f(I_F); f = \text{Parameter}$



Forward current $I_F = f(T_S)$

BAR64-02EL



Forward current $I_F = f(T_S)$

BAR64-02V



Forward current $I_F = f(T_S)$

BAR64-04, BAR64-05, BAR64-06



Forward current $I_F = f(T_S)$

BAR64-04W, BAR64-05W, BAR64-06W



Permissible Puls Load $R_{thJS} = f(t_p)$

BAR64-02EL



Permissible Pulse Load

$I_{Fmax} / I_{FDC} = f(t_p)$

BAR64-02EL



Permissible Puls Load $R_{thJS} = f(t_p)$

BAR64-02V

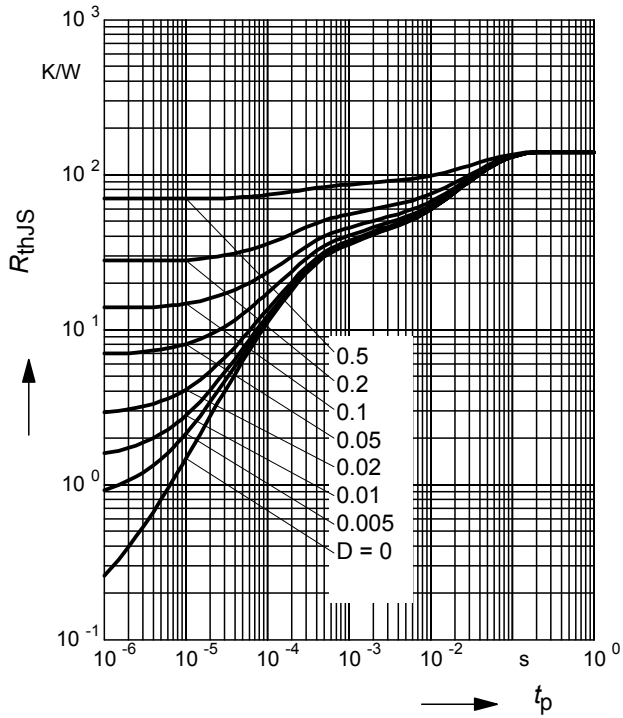

Permissible Pulse Load

$I_{Fmax} / I_{FDC} = f(t_p)$

BAR64-02V

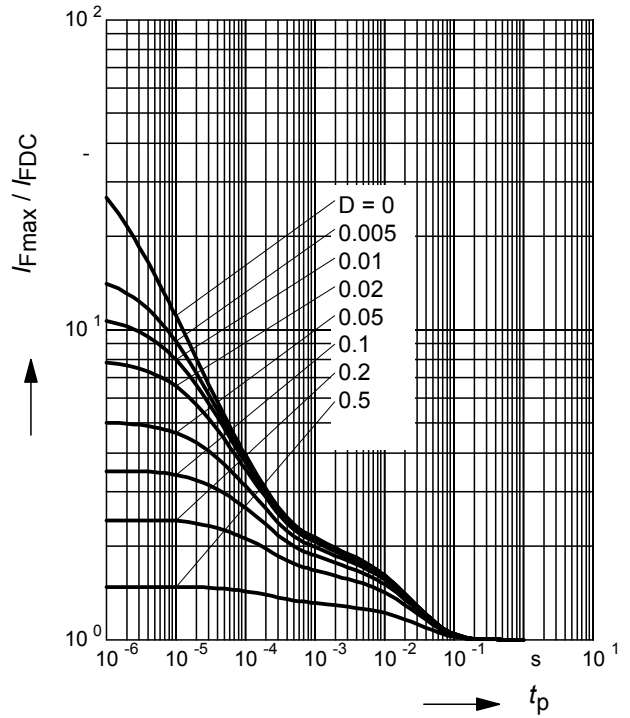

Permissible Puls Load $R_{thJS} = f(t_p)$

BAR64-04, BAR64-05, BAR64-06



Permissible Pulse Load

$I_{Fmax} / I_{FDC} = f(t_p)$

BAR64-04, BAR64-05, BAR64-06



Permissible Puls Load $R_{thJS} = f(t_p)$
 BAR64-04W, BAR64-05W, BAR64-06W

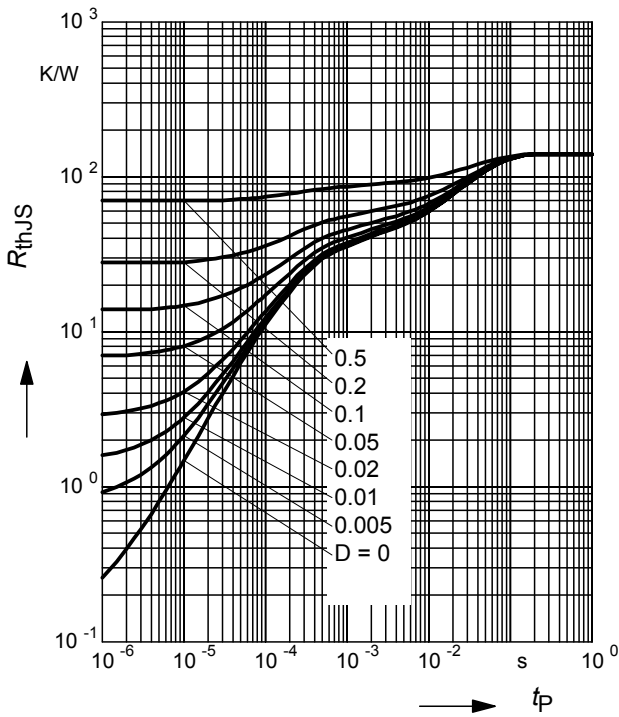

Permissible Pulse Load
 $I_{Fmax}/I_{FDC} = f(t_p)$
 BAR64-04W, BAR64-05W, BAR64-06W

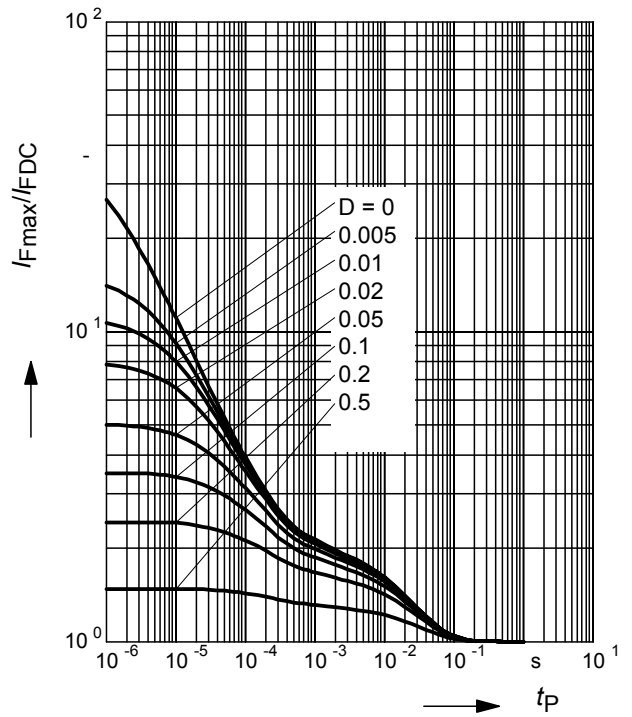

Insertion loss $I_L = -|S_{21}|^2 = f(f)$
 I_F = Parameter
 BAR64-02EL in series configuration, $Z = 50\Omega$

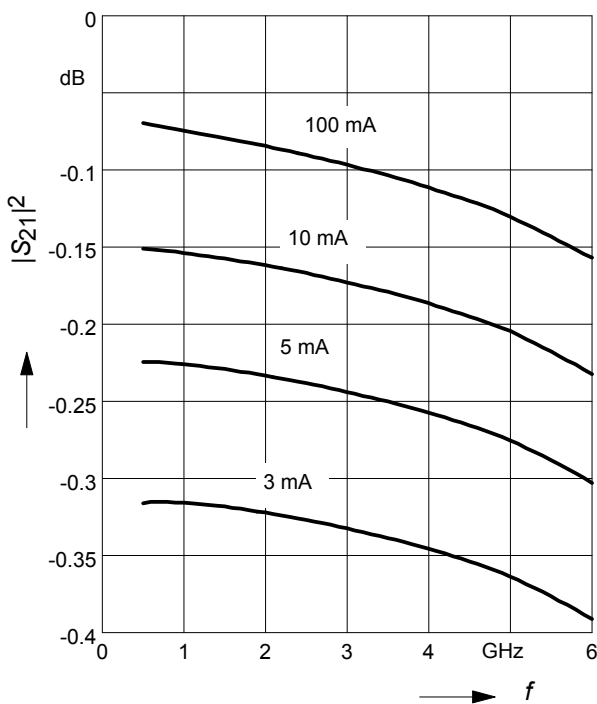

Isolation $I_{SO} = -|S_{21}|^2 = f(f)$
 V_R = Parameter
 BAR64-02EL in series configuration, $Z = 50\Omega$

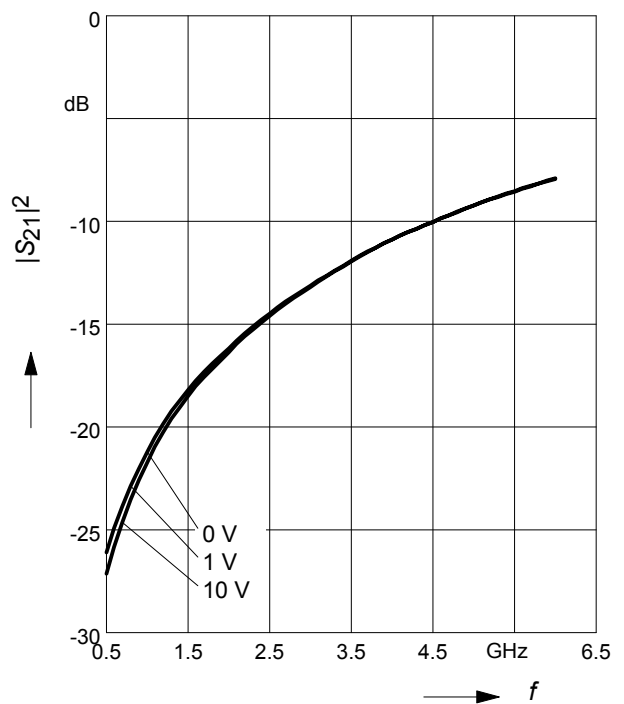

Package Outline



Foot Print



Marking Layout (Example)

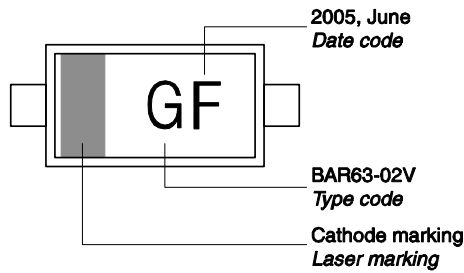

Standard Packing

- Reel ø180 mm = 3.000 Pieces/Reel
- Reel ø180 mm = 8.000 Pieces/Reel (2 mm Pitch)
- Reel ø330 mm = 10.000 Pieces/Reel

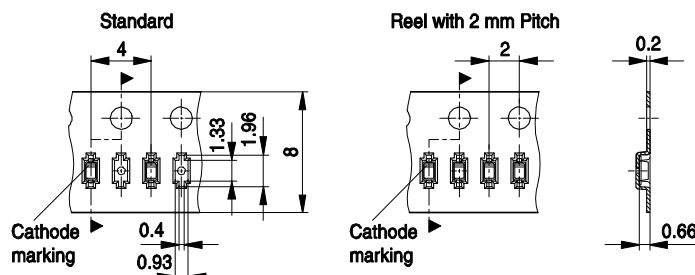

Date Code marking for discrete packages with one digit (SCD80, SC79, SC75¹⁾) CES-Code

| Month | 2003 | 2004 | 2005 | 2006 | 2007 | 2008 | 2009 | 2010 | 2011 | 2012 | 2013 | 2014 |
|-------|------|------|------|------|------|------|------|------|------|------|------|------|
| 01 | a | p | A | P | a | p | A | P | a | p | A | P |
| 02 | b | q | B | Q | b | q | B | Q | b | q | B | Q |
| 03 | c | r | C | R | c | r | C | R | c | r | C | R |
| 04 | d | s | D | S | d | s | D | S | d | s | D | S |
| 05 | e | t | E | T | e | t | E | T | e | t | E | T |
| 06 | f | u | F | U | f | u | F | U | f | u | F | U |
| 07 | g | v | G | V | g | v | G | V | g | v | G | V |
| 08 | h | x | H | X | h | x | H | X | h | x | H | X |
| 09 | j | y | J | Y | j | y | J | Y | j | y | J | Y |
| 10 | k | z | K | Z | k | z | K | Z | k | z | K | Z |
| 11 | l | 2 | L | 4 | l | 2 | L | 4 | l | 2 | L | 4 |
| 12 | n | 3 | N | 5 | n | 3 | N | 5 | n | 3 | N | 5 |

1) New Marking Layout for SC75, implemented at October 2005.

Package Outline



Foot Print

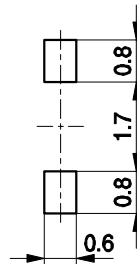

Marking Layout (Example)



Standard Packing

Reel ø180 mm = 3.000 Pieces/Reel
 Reel ø330 mm = 10.000 Pieces/Reel



Package Outline



1) Lead width can be 0.6 max. in dambar area

Foot Print



Marking Layout (Example)



Standard Packing

Reel \varnothing 180 mm = 3.000 Pieces/Reel
 Reel \varnothing 330 mm = 10.000 Pieces/Reel



Package Outline



Foot Print

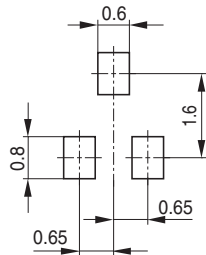

Marking Layout (Example)



Standard Packing

Reel $\varnothing 180$ mm = 3.000 Pieces/Reel
 Reel $\varnothing 330$ mm = 10.000 Pieces/Reel



Package Outline

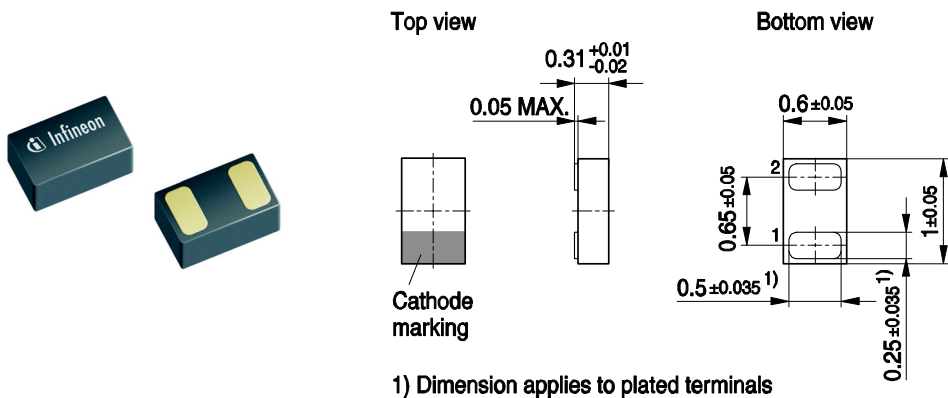

TSLP-2-19, -20-PO V01

Foot Print

For board assembly information please refer to Infineon website „Packages“



TSLP-2-19, -20-FP V01

Marking layout (Example)



Standard Packing

Reel Ø 180 mm: 15.000 Pieces / Reel
 Reel Ø 330 mm: 6.000 Pieces / Reel
 Reel Ø 330 mm: 50.000 Pieces / Reel

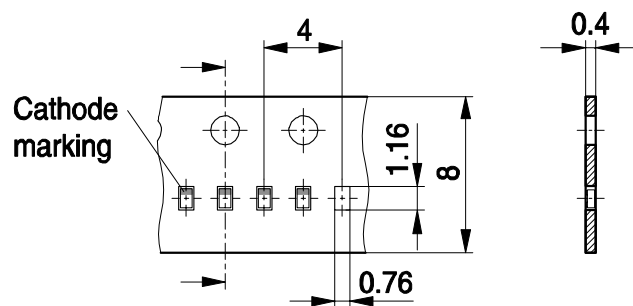

TSLP-2-19, -20-TP V02

Edition 2009-11-16

**Published by
Infineon Technologies AG
81726 Munich, Germany**

**© 2009 Infineon Technologies AG
All Rights Reserved.**

Legal Disclaimer

The information given in this document shall in no event be regarded as a guarantee of conditions or characteristics. With respect to any examples or hints given herein, any typical values stated herein and/or any information regarding the application of the device, Infineon Technologies hereby disclaims any and all warranties and liabilities of any kind, including without limitation, warranties of non-infringement of intellectual property rights of any third party.

Information

For further information on technology, delivery terms and conditions and prices, please contact the nearest Infineon Technologies Office (www.infineon.com).

Warnings

Due to technical requirements, components may contain dangerous substances. For information on the types in question, please contact the nearest Infineon Technologies Office.

Infineon Technologies components may be used in life-support devices or systems only with the express written approval of Infineon Technologies, if a failure of such components can reasonably be expected to cause the failure of that life-support device or system or to affect the safety or effectiveness of that device or system. Life support devices or systems are intended to be implanted in the human body or to support and/or maintain and sustain and/or protect human life. If they fail, it is reasonable to assume that the health of the user or other persons may be endangered.

Данный компонент на территории Российской Федерации

Вы можете приобрести в компании MosChip.

Для оперативного оформления запроса Вам необходимо перейти по данной ссылке:

<http://moschip.ru/get-element>

Вы можете разместить у нас заказ для любого Вашего проекта, будь то серийное производство или разработка единичного прибора.

В нашем ассортименте представлены ведущие мировые производители активных и пассивных электронных компонентов.

Нашей специализацией является поставка электронной компонентной базы двойного назначения, продукции таких производителей как XILINX, Intel (ex.ALTERA), Vicor, Microchip, Texas Instruments, Analog Devices, Mini-Circuits, Amphenol, Glenair.

Сотрудничество с глобальными дистрибьюторами электронных компонентов, предоставляет возможность заказывать и получать с международных складов практически любой перечень компонентов в оптимальные для Вас сроки.

На всех этапах разработки и производства наши партнеры могут получить квалифицированную поддержку опытных инженеров.

Система менеджмента качества компании отвечает требованиям в соответствии с ГОСТ Р ИСО 9001, ГОСТ РВ 0015-002 и ЭС РД 009

Офис по работе с юридическими лицами:

105318, г.Москва, ул.Щербаковская д.3, офис 1107, 1118, ДЦ «Щербаковский»

Телефон: +7 495 668-12-70 (многоканальный)

Факс: +7 495 668-12-70 (доб.304)

E-mail: info@moschip.ru

Skype отдела продаж:

moschip.ru

moschip.ru_4

moschip.ru_6

moschip.ru_9