

**Silicon PIN Diode**

- High voltage current controlled RF resistor for RF attenuator and switches
- Frequency range above 1 MHz up to 6 GHz
- Very low capacitance at zero volt reverse bias at frequencies above 1 GHz (typ. 0.17 pF)
- Low forward resistance (typ. 2.1  $\Omega$  @ 10 mA)
- Very low signal distortion
- Pb-free (RoHS compliant) package
- Qualified according AEC Q101<sup>1)</sup>



**BAR64-02EL**  
**BAR64-02V**  
**BAR64-03W**

**BAR64-04**  
**BAR64-04W**

**BAR64-05**  
**BAR64-05W**

**BAR64-06**  
**BAR64-06W**

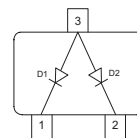
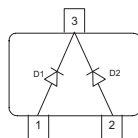
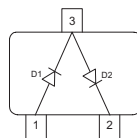

Type	Package	Configuration	$L_S$ (nH)	Marking
BAR64-02EL*	TSLP-2-19	single, leadless	0.4	OE
BAR64-02V	SC79	single	0.6	O
BAR64-03W	SOD323	single	1.8	blue 2
BAR64-04	SOT23	series	1.8	PPs
BAR64-04W	SOT323	series	1.4	PPs
BAR64-05	SOT23	common cathode	1.8	PRs
BAR64-05W	SOT323	common cathode	1.4	PRs
BAR64-06	SOT23	common anode	1.8	PSs
BAR64-06W	SOT323	common anode	1.4	PSs

<sup>1)</sup>BAR64-02EL is not qualified according AEC Q101

**Maximum Ratings** at  $T_A = 25^\circ\text{C}$ , unless otherwise specified

Parameter	Symbol	Value	Unit
Diode reverse voltage	$V_R$	150	V
Forward current	$I_F$	100	mA
Total power dissipation BAR64-02EL, $T_S \leq 135^\circ\text{C}$ BAR64-02V, $T_S \leq 125^\circ\text{C}$ BAR64-03W, $T_S \leq 25^\circ\text{C}$ BAR64-04, -05, -06, $T_S \leq 65^\circ\text{C}$ BAR64-04W, -05W, -06W, $T_S \leq 115^\circ\text{C}$	$P_{\text{tot}}$	250 250 250 250 250	mW
Junction temperature	$T_j$	150	°C
Operating temperature range	$T_{\text{op}}$	-55 ... 125	
Storage temperature	$T_{\text{stg}}$	-55 ... 150	

**Thermal Resistance**

Parameter	Symbol	Value	Unit
Junction - soldering point <sup>1)</sup> BAR64-02EL BAR64-02V, -04W, -05W, -06W BAR64-03W BAR64-04, -05, -06	$R_{\text{thJS}}$	$\leq 60$ $\leq 140$ $\leq 370$ $\leq 340$	K/W

<sup>1)</sup>For calculation of  $R_{\text{thJA}}$  please refer to Application Note AN077 (Thermal Resistance Calculation)

**Electrical Characteristics** at  $T_A = 25^\circ\text{C}$ , unless otherwise specified

Parameter	Symbol	Values			Unit
		min.	typ.	max.	
Breakdown voltage $I_{(\text{BR})} = 5 \mu\text{A}$	$V_{(\text{BR})}$	150	-	-	V
Forward voltage $I_F = 50 \text{ mA}$	$V_F$	-	-	1.1	

**DC Characteristics**

**Electrical Characteristics at  $T_A = 25^\circ\text{C}$ , unless otherwise specified**

Parameter	Symbol	Values			Unit
		min.	typ.	max.	
<b>AC Characteristics</b>					
Diode capacitance $V_R = 20\text{ V}, f = 1\text{ MHz}$ $V_R = 0\text{ V}, f = 100\text{ MHz}$ $V_R = 0\text{ V}, f = 1\dots 1.8\text{ GHz}, \text{BAR64-02EL}$ $V_R = 0\text{ V}, f = 1\dots 1.8\text{ GHz}, \text{all other}$	$C_T$	- - - -	0.23 0.3 0.13 0.17	0.35 - - -	pF
Reverse parallel resistance $V_R = 0\text{ V}, f = 100\text{ MHz}$ $V_R = 0\text{ V}, f = 1\text{ GHz}$ $V_R = 0\text{ V}, f = 1.8\text{ GHz}$	$R_P$	- - -	10 4 3	- - -	k $\Omega$
Forward resistance $I_F = 1\text{ mA}, f = 100\text{ MHz}$ $I_F = 10\text{ mA}, f = 100\text{ MHz}$ $I_F = 100\text{ mA}, f = 100\text{ MHz}$	$r_f$	- - -	12.5 2.1 0.85	20 2.8 1.35	$\Omega$
Charge carrier life time $I_F = 10\text{ mA}, I_R = 6\text{ mA}, \text{measured at } I_R = 3\text{ mA},$ $R_L = 100\ \Omega$	$\tau_{rr}$	-	1550	-	ns
I-region width	$W_I$	-	50	-	$\mu\text{m}$
Insertion loss <sup>1)</sup> $I_F = 3\text{ mA}, f = 1.8\text{ GHz}$ $I_F = 5\text{ mA}, f = 1.8\text{ GHz}$ $I_F = 10\text{ mA}, f = 1.8\text{ GHz}$	$I_L$	- - -	0.32 0.23 0.16	- - -	dB
Isolation <sup>1)</sup> $V_R = 0\text{ V}, f = 0.9\text{ GHz}$ $V_R = 0\text{ V}, f = 1.8\text{ GHz}$ $V_R = 0\text{ V}, f = 2.45\text{ GHz}$ $V_R = 0\text{ V}, f = 5.6\text{ GHz}$	$I_{SO}$	- - - -	22 17 14.5 8.5	- - - -	

<sup>1</sup>BAR64-02EL in series configuration,  $Z = 50\ \Omega$

**Diode capacitance  $C_T = f(V_R)$**

$f =$  Parameter



**Reverse parallel resistance  $R_p = f(V_R)$**

$f =$  Parameter



**Forward resistance  $r_f = f(I_F)$**

$f = 100\text{MHz}$



**Forward current  $I_F = f(V_F)$**

$T_A =$  Parameter



**Intermodulation intercept point**

$IP_3 = f(I_F); f = \text{Parameter}$



**Forward current  $I_F = f(T_S)$**

BAR64-02EL



**Forward current  $I_F = f(T_S)$**

BAR64-02V



**Forward current  $I_F = f(T_S)$**

BAR64-04, BAR64-05, BAR64-06



**Forward current  $I_F = f(T_S)$**

BAR64-04W, BAR64-05W, BAR64-06W



**Permissible Puls Load  $R_{thJS} = f(t_p)$**

BAR64-02EL



**Permissible Pulse Load**

$I_{Fmax} / I_{FDC} = f(t_p)$

BAR64-02EL



**Permissible Puls Load  $R_{thJS} = f(t_p)$**

BAR64-02V

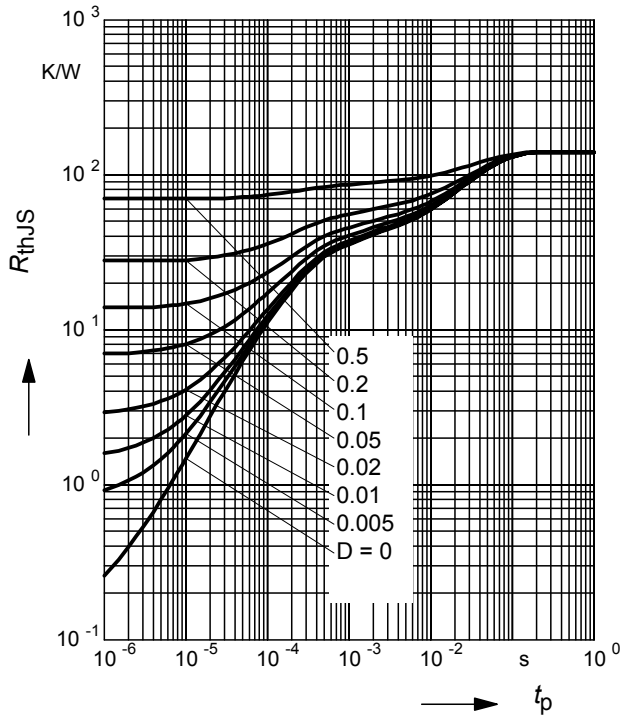

**Permissible Pulse Load**

$I_{Fmax} / I_{FDC} = f(t_p)$

BAR64-02V

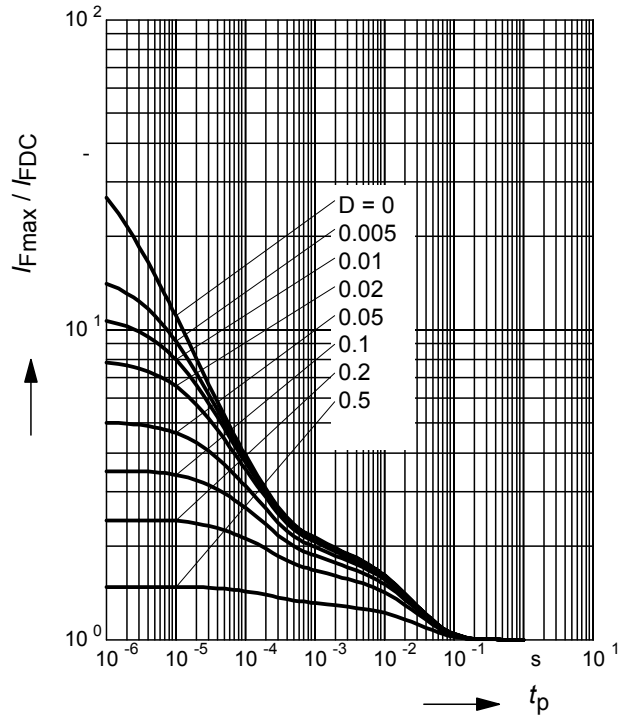

**Permissible Puls Load  $R_{thJS} = f(t_p)$**

BAR64-04, BAR64-05, BAR64-06



**Permissible Pulse Load**

$I_{Fmax} / I_{FDC} = f(t_p)$

BAR64-04, BAR64-05, BAR64-06



**Permissible Puls Load  $R_{thJS} = f(t_p)$**   
 BAR64-04W, BAR64-05W, BAR64-06W



**Permissible Pulse Load  $I_{Fmax}/I_{FDC} = f(t_p)$**   
 BAR64-04W, BAR64-05W, BAR64-06W



**Insertion loss  $I_L = -|S_{21}|^2 = f(f)$**   
 $I_F$  = Parameter  
 BAR64-02EL in series configuration,  $Z = 50\Omega$



**Isolation  $I_{SO} = -|S_{21}|^2 = f(f)$**   
 $V_R$  = Parameter  
 BAR64-02EL in series configuration,  $Z = 50\Omega$





### Package Outline



### Foot Print



### Marking Layout (Example)



### Standard Packing

- Reel  $\varnothing$ 180 mm = 3.000 Pieces/Reel
- Reel  $\varnothing$ 180 mm = 8.000 Pieces/Reel (2 mm Pitch)
- Reel  $\varnothing$ 330 mm = 10.000 Pieces/Reel



Date Code marking for discrete packages with one digit (SCD80, SC79, SC75<sup>1)</sup>) CES-Code

Month	2003	2004	2005	2006	2007	2008	2009	2010	2011	2012	2013	2014
01	a	p	A	P	a	p	A	P	a	p	A	P
02	b	q	B	Q	b	q	B	Q	b	q	B	Q
03	c	r	C	R	c	r	C	R	c	r	C	R
04	d	s	D	S	d	s	D	S	d	s	D	S
05	e	t	E	T	e	t	E	T	e	t	E	T
06	f	u	F	U	f	u	F	U	f	u	F	U
07	g	v	G	V	g	v	G	V	g	v	G	V
08	h	x	H	X	h	x	H	X	h	x	H	X
09	j	y	J	Y	j	y	J	Y	j	y	J	Y
10	k	z	K	Z	k	z	K	Z	k	z	K	Z
11	l	2	L	4	l	2	L	4	l	2	L	4
12	n	3	N	5	n	3	N	5	n	3	N	5

1) New Marking Layout for SC75, implemented at October 2005.

Package Outline



Foot Print



Marking Layout (Example)



Standard Packing

Reel ø180 mm = 3.000 Pieces/Reel  
 Reel ø330 mm = 10.000 Pieces/Reel



Package Outline



1) Lead width can be 0.6 max. in dambar area

Foot Print



Marking Layout (Example)



Standard Packing

Reel  $\varnothing$ 180 mm = 3.000 Pieces/Reel  
 Reel  $\varnothing$ 330 mm = 10.000 Pieces/Reel



Package Outline



Foot Print



Marking Layout (Example)



Standard Packing

Reel  $\varnothing$ 180 mm = 3.000 Pieces/Reel  
 Reel  $\varnothing$ 330 mm = 10.000 Pieces/Reel



Package Outline

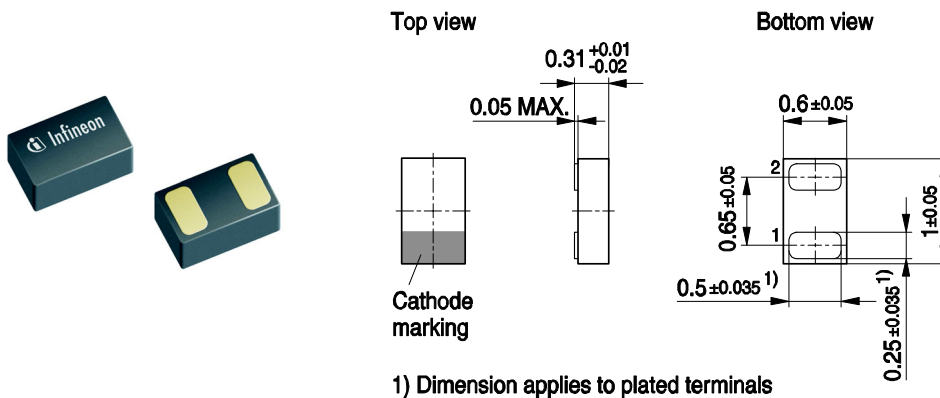

TSLP-2-19, -20-PO V01

Foot Print

For board assembly information please refer to Infineon website „Packages“



TSLP-2-19, -20-FP V01

Marking layout (Example)



Standard Packing

Reel Ø 180 mm: 15.000 Pieces / Reel  
 Reel Ø 330 mm: 6.000 Pieces / Reel  
 Reel Ø 330 mm: 50.000 Pieces / Reel

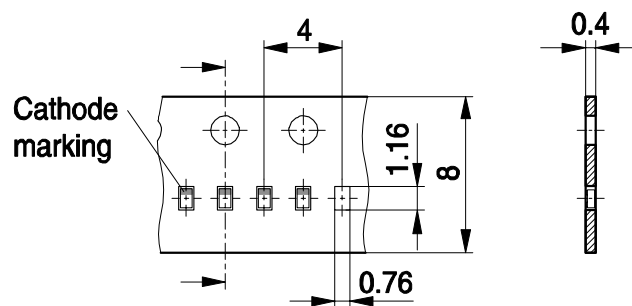

TSLP-2-19, -20-TP V02

**Edition 2009-11-16**

**Published by  
Infineon Technologies AG  
81726 Munich, Germany**

**© 2009 Infineon Technologies AG  
All Rights Reserved.**

### **Legal Disclaimer**

The information given in this document shall in no event be regarded as a guarantee of conditions or characteristics. With respect to any examples or hints given herein, any typical values stated herein and/or any information regarding the application of the device, Infineon Technologies hereby disclaims any and all warranties and liabilities of any kind, including without limitation, warranties of non-infringement of intellectual property rights of any third party.

### **Information**

For further information on technology, delivery terms and conditions and prices, please contact the nearest Infineon Technologies Office ([www.infineon.com](http://www.infineon.com)).

### **Warnings**

Due to technical requirements, components may contain dangerous substances. For information on the types in question, please contact the nearest Infineon Technologies Office.

Infineon Technologies components may be used in life-support devices or systems only with the express written approval of Infineon Technologies, if a failure of such components can reasonably be expected to cause the failure of that life-support device or system or to affect the safety or effectiveness of that device or system. Life support devices or systems are intended to be implanted in the human body or to support and/or maintain and sustain and/or protect human life. If they fail, it is reasonable to assume that the health of the user or other persons may be endangered.

## Данный компонент на территории Российской Федерации

### Вы можете приобрести в компании MosChip.

Для оперативного оформления запроса Вам необходимо перейти по данной ссылке:

<http://moschip.ru/get-element>

Вы можете разместить у нас заказ для любого Вашего проекта, будь то серийное производство или разработка единичного прибора.

В нашем ассортименте представлены ведущие мировые производители активных и пассивных электронных компонентов.

Нашей специализацией является поставка электронной компонентной базы двойного назначения, продукции таких производителей как XILINX, Intel (ex.ALTERA), Vicor, Microchip, Texas Instruments, Analog Devices, Mini-Circuits, Amphenol, Glenair.

Сотрудничество с глобальными дистрибьюторами электронных компонентов, предоставляет возможность заказывать и получать с международных складов практически любой перечень компонентов в оптимальные для Вас сроки.

На всех этапах разработки и производства наши партнеры могут получить квалифицированную поддержку опытных инженеров.

Система менеджмента качества компании отвечает требованиям в соответствии с ГОСТ Р ИСО 9001, ГОСТ РВ 0015-002 и ЭС РД 009

### Офис по работе с юридическими лицами:

105318, г.Москва, ул.Щербаковская д.3, офис 1107, 1118, ДЦ «Щербаковский»

Телефон: +7 495 668-12-70 (многоканальный)

Факс: +7 495 668-12-70 (доб.304)

E-mail: [info@moschip.ru](mailto:info@moschip.ru)

Skype отдела продаж:

moschip.ru

moschip.ru\_4

moschip.ru\_6

moschip.ru\_9