

2N6387, 2N6388

Plastic Medium-Power Silicon Transistors

These devices are designed for general-purpose amplifier and low-speed switching applications.

Features

- High DC Current Gain – $h_{FE} = 2500$ (Typ) @ $I_C = 4.0$ Adc
- Collector–Emitter Sustaining Voltage – @ 100 mA dc
 $V_{CE(sus)} = 60$ Vdc (Min) – 2N6387
 $= 80$ Vdc (Min) – 2N6388
- Low Collector–Emitter Saturation Voltage –
 $V_{CE(sat)} = 2.0$ Vdc (Max) @ $I_C = 5.0$ Adc – 2N6387, 2N6388
- Monolithic Construction with Built–In Base–Emitter Shunt Resistors
- TO–220AB Compact Package
- Pb–Free Packages are Available*

MAXIMUM RATINGS (Note 1)

| Rating | Symbol | Value | Unit |
|---|----------------|--------------|--------------------------|
| Collector–Emitter Voltage | V_{CEO} | 60 80 | Vdc |
| Collector–Base Voltage | V_{CB} | 60 80 | Vdc |
| Emitter–Base Voltage | V_{EB} | 5.0 | Vdc |
| Collector Current – Continuous – Peak | I_C | 10 15 | A dc |
| Base Current | I_B | 250 | mA dc |
| Total Power Dissipation @ $T_C = 25^\circ\text{C}$ Derate above 25°C | P_D | 65 0.52 | W W/ $^\circ\text{C}$ |
| Total Power Dissipation @ $T_A = 25^\circ\text{C}$ Derate above 25°C | P_D | 2.0 0.016 | W W/ $^\circ\text{C}$ |
| Operating and Storage Junction, Temperature Range | T_J, T_{stg} | –65 to +150 | $^\circ\text{C}$ |

THERMAL CHARACTERISTICS

| Characteristics | Symbol | Max | Unit |
|---|-----------------|------|---------------------------|
| Thermal Resistance, Junction–to–Case | $R_{\theta JC}$ | 1.92 | $^\circ\text{C}/\text{W}$ |
| Thermal Resistance, Junction–to–Ambient | $R_{\theta JA}$ | 62.5 | $^\circ\text{C}/\text{W}$ |

Stresses exceeding Maximum Ratings may damage the device. Maximum Ratings are stress ratings only. Functional operation above the Recommended Operating Conditions is not implied. Extended exposure to stresses above the Recommended Operating Conditions may affect device reliability.

1. Indicates JEDEC Registered Data.

*For additional information on our Pb–Free strategy and soldering details, please download the ON Semiconductor Soldering and Mounting Techniques Reference Manual, SOLDERRM/D.



ON Semiconductor®

<http://onsemi.com>

DARLINGTON NPN SILICON POWER TRANSISTORS 8 AND 10 AMPERES 65 WATTS, 60 – 80 VOLTS

MARKING DIAGRAM

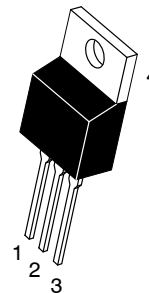

TO–220AB
CASE 221A
STYLE 1

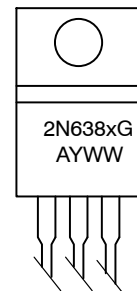

2N638x = Device Code
x = 7 or 8

G = Pb–Free Package
A = Assembly Location
Y = Year
WW = Work Week

ORDERING INFORMATION

| Device | Package | Shipping |
|---------|-----------------------|-----------------|
| 2N6387 | TO–220AB | 50 Units / Rail |
| 2N6387G | TO–220AB (Pb–Free) | 50 Units / Rail |
| 2N6388 | TO–220AB | 50 Units / Rail |
| 2N6388G | TO–220AB (Pb–Free) | 50 Units / Rail |

2N6387, 2N6388

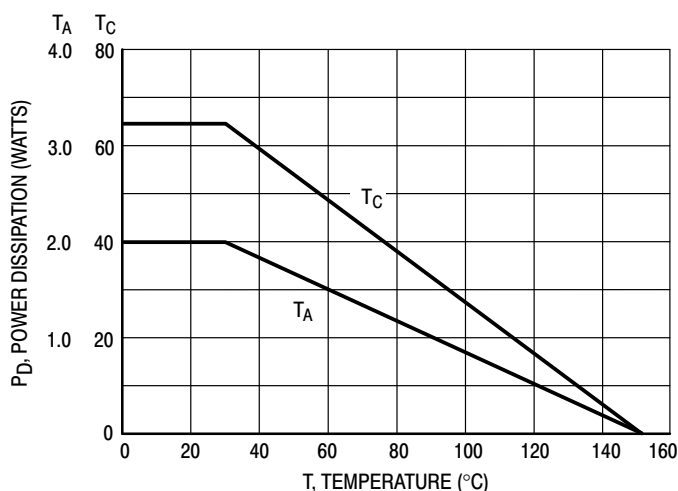

Figure 1. Power Derating

ELECTRICAL CHARACTERISTICS ($T_C = 25^\circ\text{C}$ unless otherwise noted) (Note 2)

| Characteristic | Symbol | Min | Max | Unit | |
|--|--------------------------------------|----------------|------------------|--------------------------|-------------------------|
| OFF CHARACTERISTICS | | | | | |
| Collector-Emitter Sustaining Voltage (Note 3) ($I_C = 200\text{ mAdc}$, $I_B = 0$) | 2N6387 2N6388 | $V_{CEO(sus)}$ | 60 80 | – – | Vdc |
| Collector Cutoff Current ($V_{CE} = 60\text{ Vdc}$, $I_B = 0$) ($V_{CE} = 80\text{ Vdc}$, $I_B = 0$) | 2N6387 2N6388 | I_{CEO} | – – | 1.0 1.0 | mAdc |
| Collector Cutoff Current ($V_{CE} = 60\text{ Vdc}$, $V_{EB(off)} = 1.5\text{ Vdc}$) ($V_{CE} = 80\text{ Vdc}$, $V_{EB(off)} = 1.5\text{ Vdc}$) ($V_{CE} = 60\text{ Vdc}$, $V_{EB(off)} = 1.5\text{ Vdc}$, $T_C = 125^\circ\text{C}$) ($V_{CE} = 80\text{ Vdc}$, $V_{EB(off)} = 1.5\text{ Vdc}$, $T_C = 125^\circ\text{C}$) | 2N6387 2N6388 2N6387 2N6388 | I_{CEX} | – – – – | 300 300 3.0 3.0 | μAdc mAdc |
| Emitter Cutoff Current ($V_{BE} = 5.0\text{ Vdc}$, $I_C = 0$) | | I_{EBO} | – | 5.0 | mAdc |
| ON CHARACTERISTICS (Note 3) | | | | | |
| DC Current Gain ($I_C = 5.0\text{ Adc}$, $V_{CE} = 3.0\text{ Vdc}$) ($I_C = 1.0\text{ Adc}$, $V_{CE} = 3.0\text{ Vdc}$) | 2N6387, 2N6388 2N6387, 2N6388 | h_{FE} | 1000 100 | 20,000 – | – |
| Collector-Emitter Saturation Voltage ($I_C = 5.0\text{ Adc}$, $I_B = 0.01\text{ Adc}$) ($I_C = 10\text{ Adc}$, $I_B = 0.1\text{ Adc}$) | 2N6387, 2N6388 2N6387, 2N6388 | $V_{CE(sat)}$ | – – | 2.0 3.0 | Vdc |
| Base-Emitter On Voltage ($I_C = 5.0\text{ Adc}$, $V_{CE} = 3.0\text{ Vdc}$) ($I_C = 10\text{ Adc}$, $V_{CE} = 3.0\text{ Vdc}$) | 2N6387, 2N6388 2N6387, 2N6388 | $V_{BE(on)}$ | – – | 2.8 4.5 | Vdc |
| DYNAMIC CHARACTERISTICS | | | | | |
| Small-Signal Current Gain ($I_C = 1.0\text{ Adc}$, $V_{CE} = 5.0\text{ Vdc}$, $f_{test} = 1.0\text{ MHz}$) | | $ h_{fe} $ | 20 | – | – |
| Output Capacitance ($V_{CB} = 10\text{ Vdc}$, $I_E = 0$, $f = 1.0\text{ MHz}$) | | C_{ob} | – | 200 | pF |
| Small-Signal Current Gain ($I_C = 1.0\text{ Adc}$, $V_{CE} = 5.0\text{ Vdc}$, $f = 1.0\text{ kHz}$) | | h_{fe} | 1000 | – | – |

2. Indicates JEDEC Registered Data.

3. Pulse Test: Pulse Width $\leq 300\ \mu\text{s}$, Duty Cycle $\leq 2.0\%$.

2N6387, 2N6388

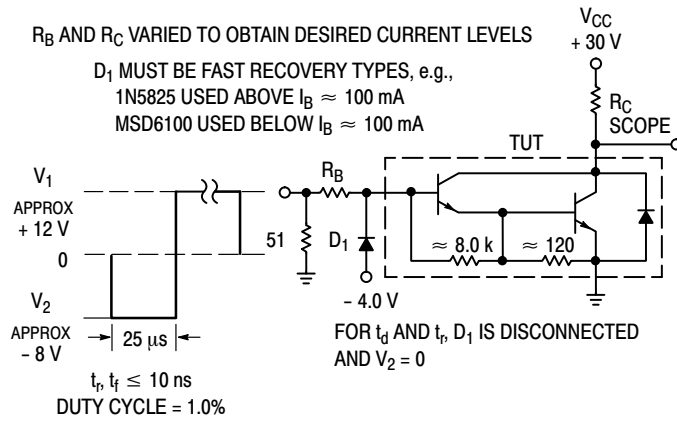

Figure 2. Switching Times Test Circuit

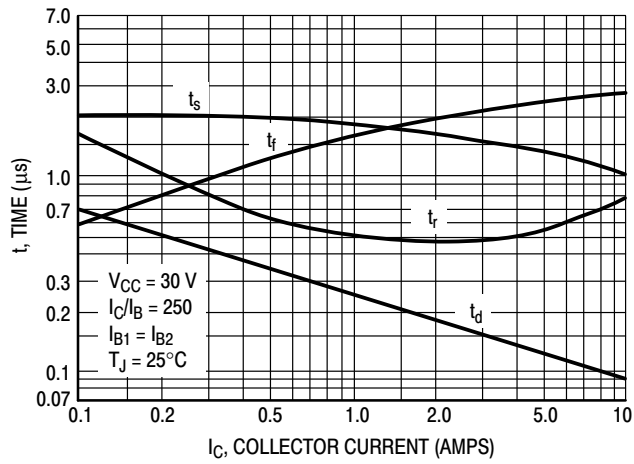

Figure 3. Switching Times

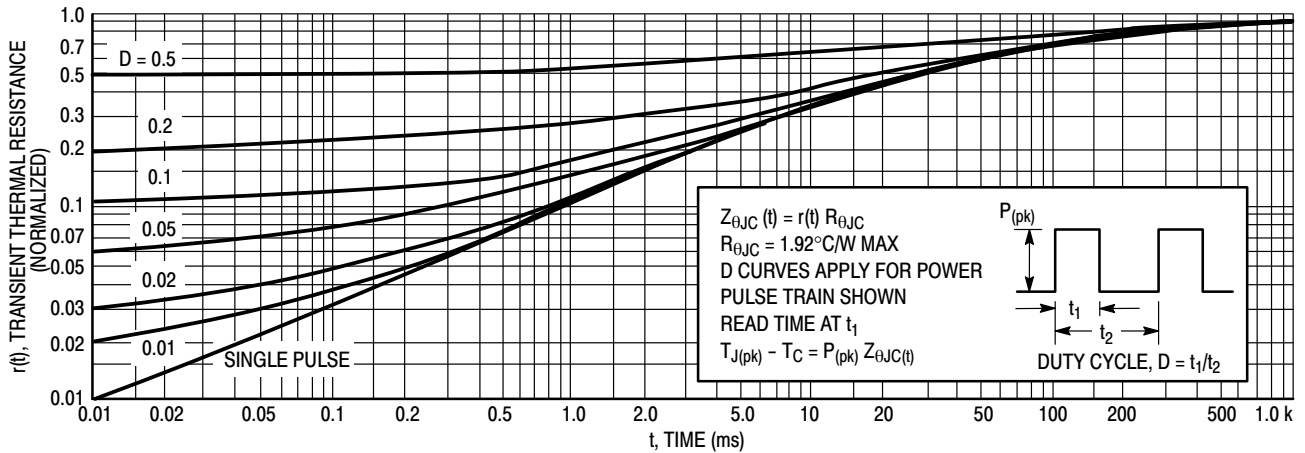

Figure 4. Thermal Response

2N6387, 2N6388

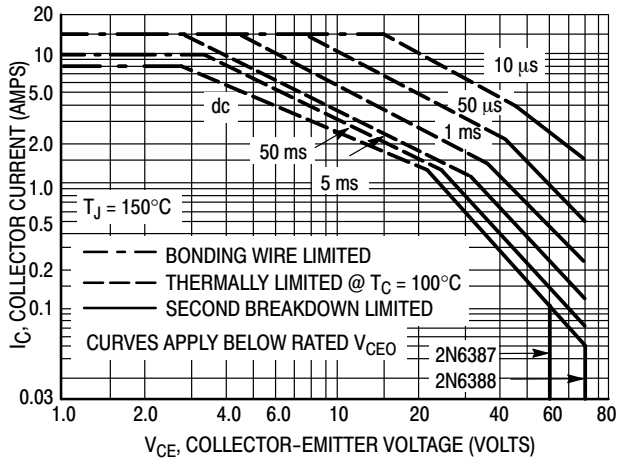

Figure 5. Active-Region Safe Operating Area

There are two limitations on the power handling ability of a transistor: average junction temperature and second breakdown. Safe operating area curves indicate $I_C - V_{CE}$ limits of the transistor that must be observed for reliable operation; i.e., the transistor must not be subjected to greater dissipation than the curves indicate.

The data of Figure 5 is based on $T_{J(pk)} = 150^\circ\text{C}$; T_C is variable depending on conditions. Second breakdown pulse limits are valid for duty cycles to 10% provided $T_{J(pk)} < 150^\circ\text{C}$. $T_{J(pk)}$ may be calculated from the data in Figure 4. At high case temperatures, thermal limitations will reduce the power that can be handled to values less than the limitations imposed by second breakdown

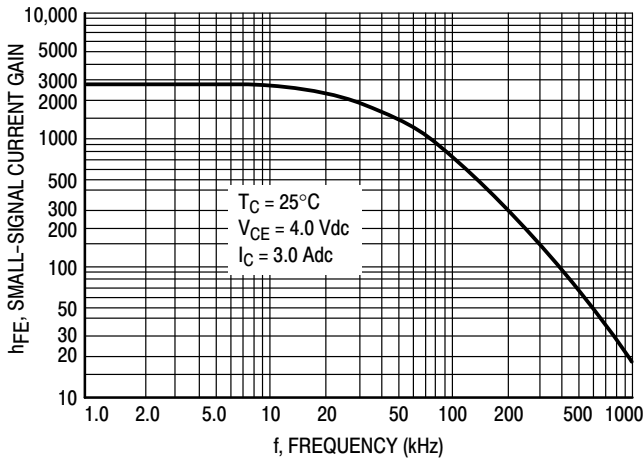

Figure 6. Small-Signal Current Gain

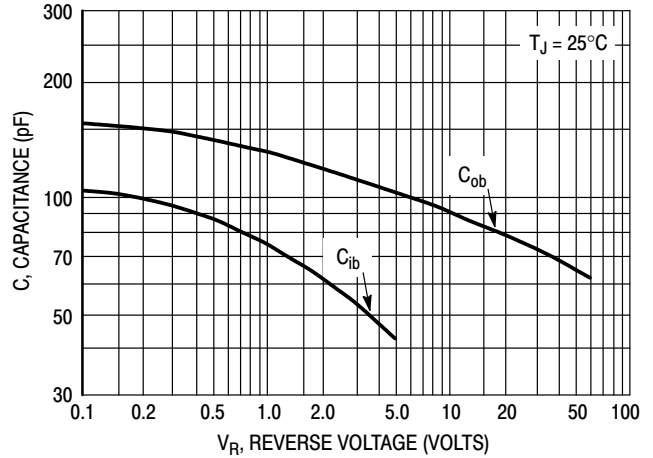

Figure 7. Capacitance

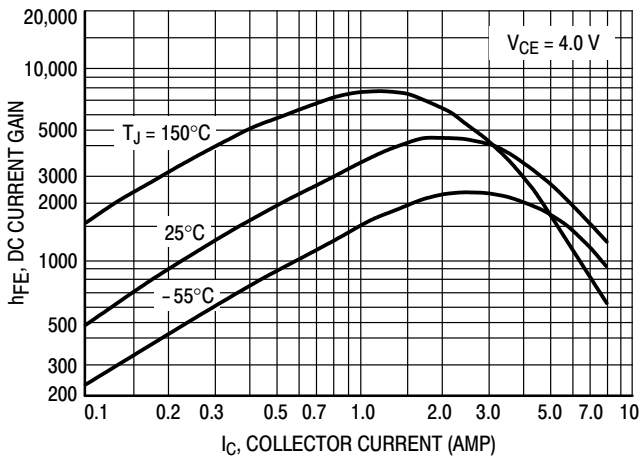

Figure 8. DC Current Gain

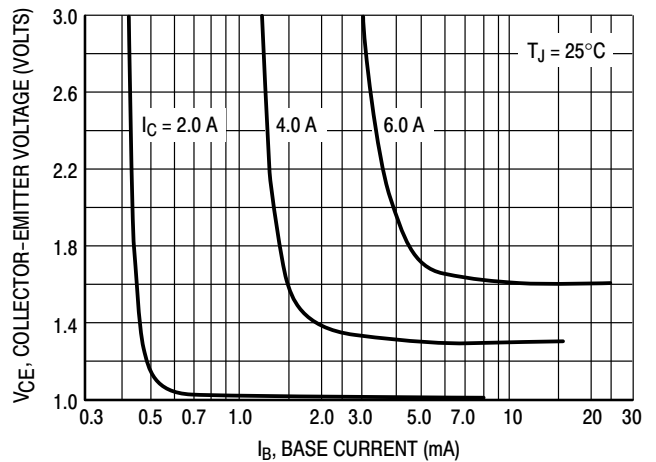

Figure 9. Collector Saturation Region

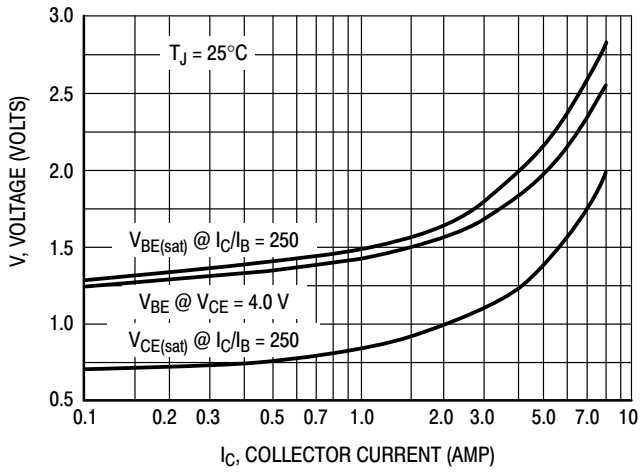

Figure 10. "On" Voltages

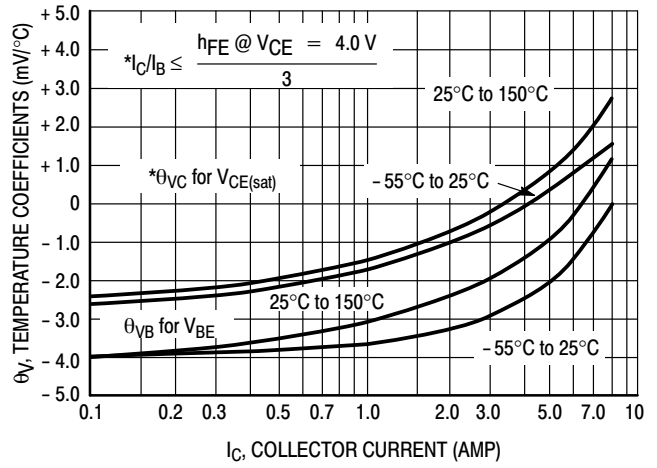

Figure 11. Temperature Coefficients

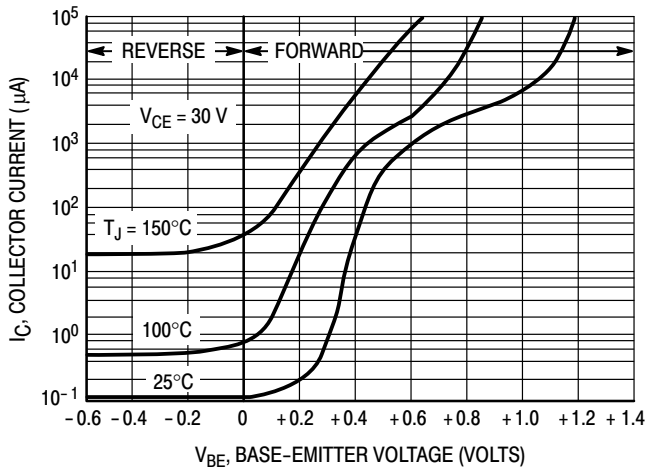

Figure 12. Collector Cut-Off Region

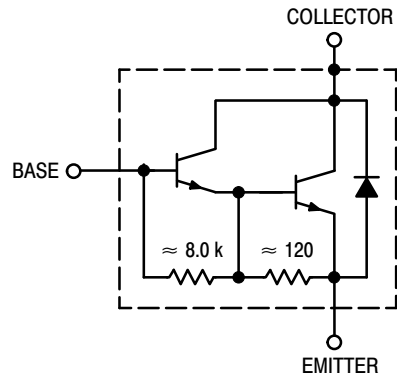
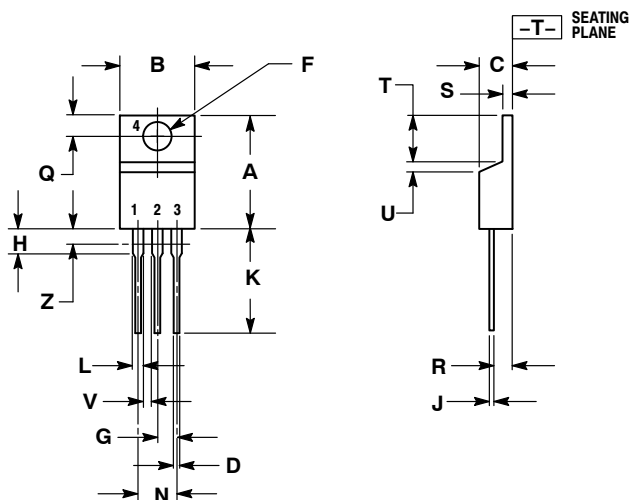

Figure 13. Darlington Schematic

2N6387, 2N6388

PACKAGE DIMENSIONS

TO-220 CASE 221A-09 ISSUE AG



- NOTES:
1. DIMENSIONING AND TOLERANCING PER ANSI Y14.5M, 1982.
 2. CONTROLLING DIMENSION: INCH.
 3. DIMENSION Z DEFINES A ZONE WHERE ALL BODY AND LEAD IRREGULARITIES ARE ALLOWED.

| DIM | INCHES | | MILLIMETERS | |
|-----|--------|-------|-------------|-------|
| | MIN | MAX | MIN | MAX |
| A | 0.570 | 0.620 | 14.48 | 15.75 |
| B | 0.380 | 0.405 | 9.66 | 10.28 |
| C | 0.160 | 0.190 | 4.07 | 4.82 |
| D | 0.025 | 0.036 | 0.64 | 0.91 |
| F | 0.142 | 0.161 | 3.61 | 4.09 |
| G | 0.095 | 0.105 | 2.42 | 2.66 |
| H | 0.110 | 0.161 | 2.80 | 4.10 |
| J | 0.014 | 0.025 | 0.36 | 0.64 |
| K | 0.500 | 0.562 | 12.70 | 14.27 |
| L | 0.045 | 0.060 | 1.15 | 1.52 |
| N | 0.190 | 0.210 | 4.83 | 5.33 |
| Q | 0.100 | 0.120 | 2.54 | 3.04 |
| R | 0.080 | 0.110 | 2.04 | 2.79 |
| S | 0.045 | 0.055 | 1.15 | 1.39 |
| T | 0.235 | 0.255 | 5.97 | 6.47 |
| U | 0.000 | 0.050 | 0.00 | 1.27 |
| V | 0.045 | --- | 1.15 | --- |
| Z | --- | 0.080 | --- | 2.04 |

- STYLE 1:
PIN 1. BASE
2. COLLECTOR
3. EMITTER
4. COLLECTOR

ON Semiconductor and are registered trademarks of Semiconductor Components Industries, LLC (SCILLC). SCILLC reserves the right to make changes without further notice to any products herein. SCILLC makes no warranty, representation or guarantee regarding the suitability of its products for any particular purpose, nor does SCILLC assume any liability arising out of the application or use of any product or circuit, and specifically disclaims any and all liability, including without limitation special, consequential or incidental damages. "Typical" parameters which may be provided in SCILLC data sheets and/or specifications can and do vary in different applications and actual performance may vary over time. All operating parameters, including "Typicals" must be validated for each customer application by customer's technical experts. SCILLC does not convey any license under its patent rights nor the rights of others. SCILLC products are not designed, intended, or authorized for use as components in systems intended for surgical implant into the body, or other applications intended to support or sustain life, or for any other application in which the failure of the SCILLC product could create a situation where personal injury or death may occur. Should Buyer purchase or use SCILLC products for any such unintended or unauthorized application, Buyer shall indemnify and hold SCILLC and its officers, employees, subsidiaries, affiliates, and distributors harmless against all claims, costs, damages, and expenses, and reasonable attorney fees arising out of, directly or indirectly, any claim of personal injury or death associated with such unintended or unauthorized use, even if such claim alleges that SCILLC was negligent regarding the design or manufacture of the part. SCILLC is an Equal Opportunity/Affirmative Action Employer. This literature is subject to all applicable copyright laws and is not for resale in any manner.

PUBLICATION ORDERING INFORMATION

LITERATURE FULFILLMENT:
Literature Distribution Center for ON Semiconductor
P.O. Box 5163, Denver, Colorado 80217 USA
Phone: 303-675-2175 or 800-344-3860 Toll Free USA/Canada
Fax: 303-675-2176 or 800-344-3867 Toll Free USA/Canada
Email: orderlit@onsemi.com

N. American Technical Support: 800-282-9855 Toll Free
USA/Canada
Europe, Middle East and Africa Technical Support:
Phone: 421 33 790 2910
Japan Customer Focus Center
Phone: 81-3-5817-1050

ON Semiconductor Website: www.onsemi.com
Order Literature: <http://www.onsemi.com/orderlit>

For additional information, please contact your local Sales Representative

Данный компонент на территории Российской Федерации

Вы можете приобрести в компании MosChip.

Для оперативного оформления запроса Вам необходимо перейти по данной ссылке:

<http://moschip.ru/get-element>

Вы можете разместить у нас заказ для любого Вашего проекта, будь то серийное производство или разработка единичного прибора.

В нашем ассортименте представлены ведущие мировые производители активных и пассивных электронных компонентов.

Нашей специализацией является поставка электронной компонентной базы двойного назначения, продукции таких производителей как XILINX, Intel (ex.ALTERA), Vicor, Microchip, Texas Instruments, Analog Devices, Mini-Circuits, Amphenol, Glenair.

Сотрудничество с глобальными дистрибьюторами электронных компонентов, предоставляет возможность заказывать и получать с международных складов практически любой перечень компонентов в оптимальные для Вас сроки.

На всех этапах разработки и производства наши партнеры могут получить квалифицированную поддержку опытных инженеров.

Система менеджмента качества компании отвечает требованиям в соответствии с ГОСТ Р ИСО 9001, ГОСТ РВ 0015-002 и ЭС РД 009

Офис по работе с юридическими лицами:

105318, г.Москва, ул.Щербаковская д.3, офис 1107, 1118, ДЦ «Щербаковский»

Телефон: +7 495 668-12-70 (многоканальный)

Факс: +7 495 668-12-70 (доб.304)

E-mail: info@moschip.ru

Skype отдела продаж:

moschip.ru

moschip.ru_4

moschip.ru_6

moschip.ru_9