

FEATURES

- FOUT Output frequency: 25kHz
 - $R_{SET} = 4.32M\Omega$
- PWMOUT Output Duty Cycle Range:
 - 12% to 90%
- Programmable Frequency Range:
 - $5.2kHz \leq FOUT \leq 90kHz$
- Fully Assembled and Tested
- 2in x 2in 2-layer circuit board

COMPONENT LIST

DESIGNATION	QTY	DESCRIPTION
C1	1	0.1 μ F \pm 10% capacitor (0805)
R1	1	4.32M Ω \pm 1% (0805)
R2	1	1M Ω \pm 1% (0805)
PWM_ADJ	1	1M Ω Potentiometer
U1	1	TS3001
VDD-GND,F-OUT, PWM_OUT	3	Test points
J2	1	Jumper

DESCRIPTION

The demo board for the TS3001 is a completely assembled and tested circuit board that can be used for evaluating the TS3001. The TS3001 joins Touchstone's TS3002 CMOS oscillator in the "NanoWatt Analog™" high-performance analog integrated circuits portfolio. The TS3001 is fully specified to operate at 1V while consuming a 1 μ A supply current at an output frequency of 25kHz. The TS3001 can operate from a single-supply voltage from 0.9V to 1.8V.

The TS3001 requires only a resistor to set the output frequency. The demo board is available with an on-board 4.32M Ω R_{SET} resistor that sets FOUT at 25kHz. In addition, a PWMOUT output is made available where a voltage controlled pin is available to modulate the duty cycle of the signal from 12% to 90%. The TS3001 is fully specified over the -40°C to +85°C temperature range and is available in a low-profile, 8-pin 2x2mm TDFN package with an exposed back-side paddle.

Product datasheet and additional documentation can be found on the factory web site at www.touchstonesemi.com.

ORDERING INFORMATION

Order Number	Description
TS3001DB	TS3001 Demo Board

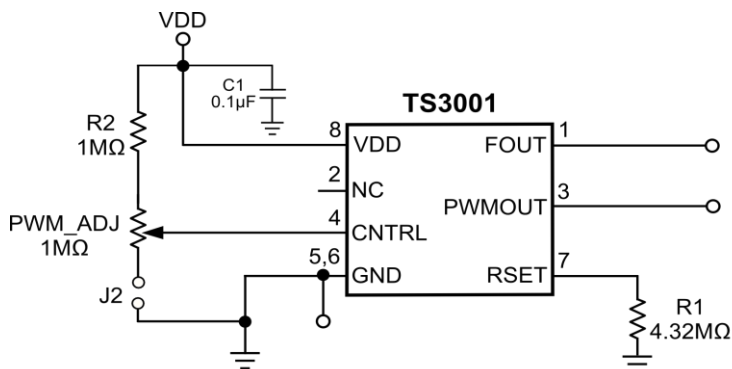

Figure 1. TS3001 Oscillator/Timer Circuit



Figure 2. TS3001 Evaluation Board

DESCRIPTION

The demo board includes an on-board 0.1μF decoupling capacitor at the V_{DD} pin. To modulate the duty cycle of the PWMOUT signal, adjust the potentiometer counter-clockwise to increase the duty cycle and vice versa. The PWMOUT is wired anti-phase with the FOUT output and can be disabled by removing jumper J2.

The TS3001 is a user-programmable oscillator where the period of the square wave at its FOUT terminal is generated by an external resistor. The output frequency is given by:

$$F_{OUT} \text{ (kHz)} = \frac{1}{t_{FOUT} \text{ (}\mu\text{s)}} = \frac{1E6}{k \times R_{SET} \text{ (M}\Omega)}$$

where the scalar k is approximately 9.09E3. As design aids, Table 1 lists TS3001's typical FOUT for various standard values for R_{SET}. Furthermore, refer to Figure 4 and Figure 5 on page 3 for plots of FOUT period and frequency vs R_{SET}.

Table 1: FOUT vs R_{SET}

R _{SET} (MΩ)	FOUT (kHz)
1	110
2.49	44
4.32	25.5
6.81	16
9.76	11

QUICK START PROCEDURE

Required Equipment

- TS3001 Demo Board
- A 1.5V Alkaline Battery Cell or a DC Power Supply
- Oscilloscope Model Agilent DSO1014A or equivalent
- Two 10X, 15pF//10MΩ oscilloscope probes
- Potentiometer screwdriver

To evaluate the TS3001 resistor-tuned silicon oscillator/timer, the following steps are to be performed:

- 1) Before connecting the DC power supply to the demo board, turn on the power supply, set the DC voltage to 1V, and then turn it off.

- 2) Connect the DC power supply positive terminal to the test point labeled VDD. Connect the negative terminal of the DC power supply to the test point labeled GND.
- 3) To monitor the FOUT output signal, connect the signal terminal of an oscilloscope probe to the test point labeled FOUT and the ground terminal to the test point labeled GND.
- 4) To monitor the PWMOUT output signal, connect the signal terminal of a second oscilloscope probe to the test point labeled PWMOUT and the ground terminal to the test point labeled GND.
- 5) To minimize transient power consumption because of the probe capacitance of the oscilloscope, a series-connected capacitor can be added at either or both FOUT and PWMOUT terminals. To determine what the external series capacitor value should be, use the following expression:

$$C_{EXT} = \frac{1}{\frac{1}{C_{LOAD(EFF)}} - \frac{1}{C_{PROBE}}}$$

where C_{EXT} is the external series capacitor, C_{LOAD(EFF)} is the effective load capacitance, and C_{PROBE} is the capacitance of the oscilloscope probe. Figure 3 shows this technique.

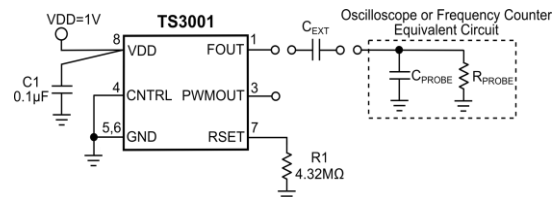

Figure 3. Probe Capacitance Reduction Circuit

- 6) Select two channels on the oscilloscope and set the vertical voltage scale and the vertical position on each channel to 200mV/DIV and 500mV, respectively. Set the horizontal time scale to 20μs/DIV. The coupling should be DC coupling. Turn on the power supply. The supply current will vary depending on the load on the output and whether the PWMOUT is enabled or disabled. Given the default set-up on the board, the PWMOUT duty cycle is set to ~49.3%. With an output load of 15pF on both FOUT and PWMOUT outputs due to the oscilloscope probes, the supply current should be less than 3μA. Refer to step 5 in order to minimize transient power consumption due to the probe capacitance, which can, in turn, reduce the transient supply current.

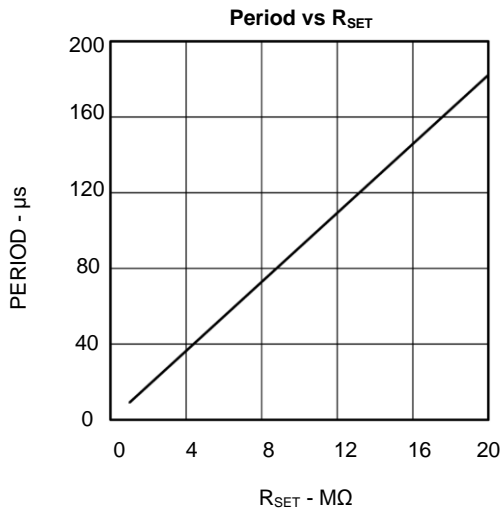

Figure 4. FOUT Period vs R_{SET}

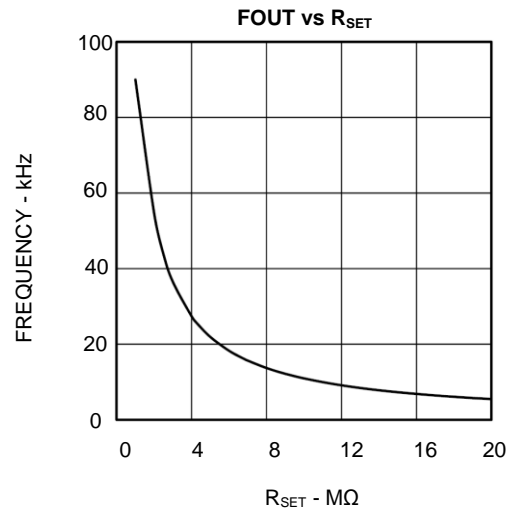

Figure 5. FOUT Frequency vs R_{SET}

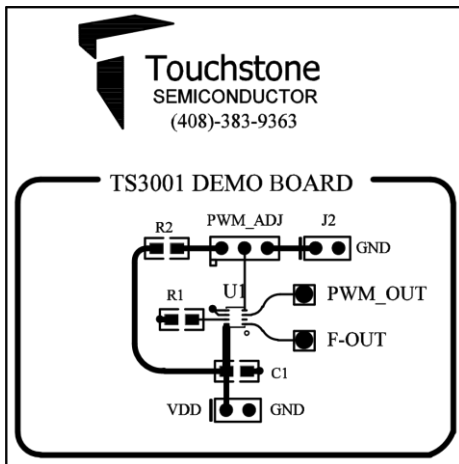

Figure 6. Top Layer Component View

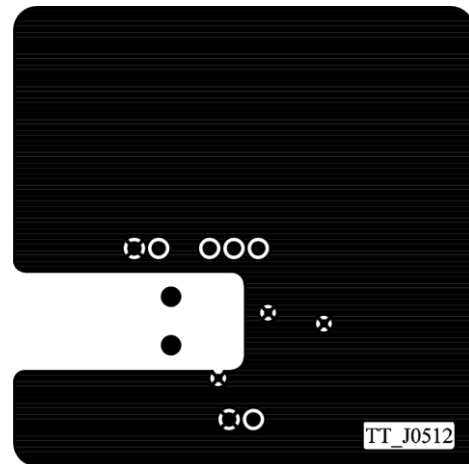

Figure 7. Bottom Layer (GND)

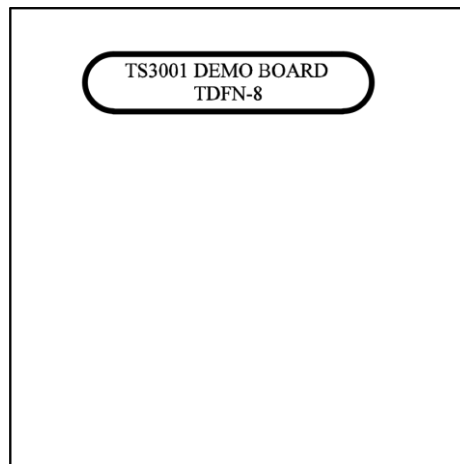

Figure 8. Bottom Layer (GND) #2

Данный компонент на территории Российской Федерации

Вы можете приобрести в компании MosChip.

Для оперативного оформления запроса Вам необходимо перейти по данной ссылке:

<http://moschip.ru/get-element>

Вы можете разместить у нас заказ для любого Вашего проекта, будь то серийное производство или разработка единичного прибора.

В нашем ассортименте представлены ведущие мировые производители активных и пассивных электронных компонентов.

Нашей специализацией является поставка электронной компонентной базы двойного назначения, продукции таких производителей как XILINX, Intel (ex.ALTERA), Vicor, Microchip, Texas Instruments, Analog Devices, Mini-Circuits, Amphenol, Glenair.

Сотрудничество с глобальными дистрибьюторами электронных компонентов, предоставляет возможность заказывать и получать с международных складов практически любой перечень компонентов в оптимальные для Вас сроки.

На всех этапах разработки и производства наши партнеры могут получить квалифицированную поддержку опытных инженеров.

Система менеджмента качества компании отвечает требованиям в соответствии с ГОСТ Р ИСО 9001, ГОСТ РВ 0015-002 и ЭС РД 009

Офис по работе с юридическими лицами:

105318, г.Москва, ул.Щербаковская д.3, офис 1107, 1118, ДЦ «Щербаковский»

Телефон: +7 495 668-12-70 (многоканальный)

Факс: +7 495 668-12-70 (доб.304)

E-mail: info@moschip.ru

Skype отдела продаж:

moschip.ru

moschip.ru_4

moschip.ru_6

moschip.ru_9