

# Converter - Inverter Module

## NPT IGBT

Single Phase Rectifier	Three Phase Inverter
$V_{RRM} = 1600 \text{ V}$	$V_{CES} = 600 \text{ V}$
$I_{DAVM25} = 65 \text{ A}$	$I_{C25} = 23 \text{ A}$
$I_{FSM} = 550 \text{ A}$	$V_{CE(sat)} = 2.1 \text{ V}$

**Part name** (Marking on product)

MIAA15WD600TMH

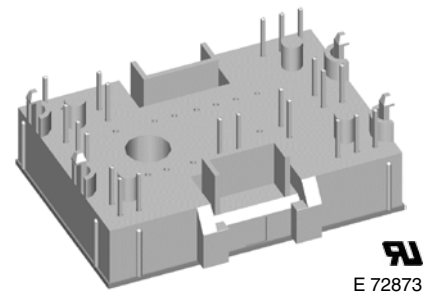
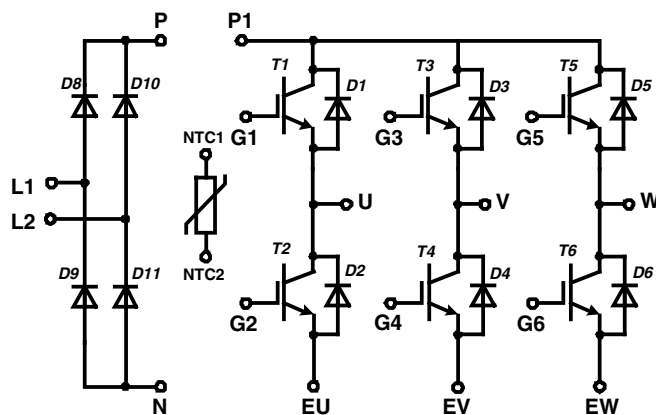

E 72873

Pin configuration see outlines.

### Features:

- High level of integration - only one power semiconductor module required for the whole drive
- Inverter with NPT IGBTs
  - low saturation voltage
  - positive temperature coefficient
  - fast switching
  - short tail current
- Epitaxial free wheeling diodes with hiperfast soft reverse recovery
- Temperature sense included

### Application:

- AC motor drives
- Pumps, Fans
- Washing machines
- Air-conditioning system
- Inverter and power supplies

### Package:

- "Mini" package
- Assembly height is 17 mm
- Insulated base plate
- Pins suitable for wave soldering and PCB mounting
- Assembly clips available
  - IXKU 5-505 screw clamp
  - IXRB 5-506 click clamp
- UL registered E72873

**Output Inverter T1 - T6**

Symbol	Definitions	Conditions	Ratings			Unit	
			min.	typ.	max.		
$V_{CES}$	collector emitter voltage		$T_{VJ} = 150^{\circ}\text{C}$		600	V	
$V_{GES}$	max. DC gate voltage	continuous			$\pm 20$	V	
$V_{GEM}$	max. transient collector gate voltage	transient			$\pm 30$	V	
$I_{C25}$	collector current		$T_C = 25^{\circ}\text{C}$		23	A	
$I_{C80}$			$T_C = 80^{\circ}\text{C}$		16	A	
$P_{tot}$	total power dissipation		$T_C = 25^{\circ}\text{C}$		80	W	
$V_{CE(sat)}$	collector emitter saturation voltage	$I_C = 15\text{ A}; V_{GE} = 15\text{ V}$	$T_{VJ} = 25^{\circ}\text{C}$ $T_{VJ} = 125^{\circ}\text{C}$	2.1 2.3	2.5	V V	
$V_{GE(th)}$	gate emitter threshold voltage	$I_C = 0.4\text{ A}; V_{GE} = V_{CE}$	$T_{VJ} = 25^{\circ}\text{C}$	4.5	5.5	6.5	V
$I_{CES}$	collector emitter leakage current	$V_{CE} = V_{CES}; V_{GE} = 0\text{ V}$	$T_{VJ} = 25^{\circ}\text{C}$ $T_{VJ} = 125^{\circ}\text{C}$		1.0	0.6	mA mA
$I_{GES}$	gate emitter leakage current	$V_{GE} = \pm 20\text{ V}$			150	nA	
$C_{ies}$	input capacitance	$V_{CE} = 25\text{ V}; V_{GE} = 0\text{ V}; f = 1\text{ MHz}$			700	pF	
$Q_{G(on)}$	total gate charge	$V_{CE} = 300\text{ V}; V_{GE} = 15\text{ V}; I_C = 15\text{ A}$			57	nC	
$t_{d(on)}$	turn-on delay time	inductive load $V_{CE} = 300\text{ V}; I_C = 15\text{ A}$ $V_{GE} = \pm 15\text{ V}; R_G = 68\ \Omega$	$T_{VJ} = 25^{\circ}\text{C}$		40	ns	
$t_r$	current rise time				45	ns	
$t_{d(off)}$	turn-off delay time				155	ns	
$t_f$	current fall time				95	ns	
$E_{on}$	turn-on energy per pulse				0.35	mJ	
$E_{off}$	turn-off energy per pulse				0.27	mJ	
$t_{d(on)}$	turn-on delay time	inductive load $V_{CE} = 300\text{ V}; I_C = 15\text{ A}$ $V_{GE} = \pm 15\text{ V}; R_G = 68\ \Omega$	$T_{VJ} = 125^{\circ}\text{C}$		40	ns	
$t_r$	current rise time				45	ns	
$t_{d(off)}$	turn-off delay time				160	ns	
$t_f$	current fall time				120	ns	
$E_{on}$	turn-on energy per pulse				0.55	mJ	
$E_{off}$	turn-off energy per pulse				0.4	mJ	
<b>RBSOA</b>	reverse bias safe operating area	$V_{GE} = \pm 15\text{ V}; R_G = 68\ \Omega; I_C = 30\text{ A}$	$T_{VJ} = 125^{\circ}\text{C}$	$V_{CEK} \leq V_{CES} - L_S \cdot di/dt$		V	
<b><math>I_{SC}</math> (SCSOA)</b>	short circuit safe operating area	$V_{CE} = 360\text{ V}; V_{GE} = \pm 15\text{ V};$ $R_G = 68\ \Omega; t_p = 10\ \mu\text{s};$ non-repetitive	$T_{VJ} = 125^{\circ}\text{C}$	65		A	
$R_{thJC}$	thermal resistance junction to case	(per IGBT)			1.6	K/W	
$R_{thCH}$	thermal resistance case to heatsink			0.55		K/W	

**Output Inverter D1 - D6**

Symbol	Definitions	Conditions	Ratings			Unit
			min.	typ.	max.	
$V_{RRM}$	max. repetitive reverse voltage		$T_{VJ} = 150^{\circ}\text{C}$		600	V
$I_{F25}$	forward current		$T_C = 25^{\circ}\text{C}$		37	A
$I_{F80}$			$T_C = 80^{\circ}\text{C}$		24	A
$V_F$	forward voltage	$I_F = 15\text{ A}; V_{GE} = 0\text{ V}$	$T_{VJ} = 25^{\circ}\text{C}$ $T_{VJ} = 125^{\circ}\text{C}$	1.8 1.3	2.1	V V
$Q_{rr}$	reverse recovery charge	$V_R = 300\text{ V}$ $di_F/dt = -380\text{ A}/\mu\text{s}$ $I_F = 15\text{ A}; V_{GE} = 0\text{ V}$	$T_{VJ} = 125^{\circ}\text{C}$		0.58	$\mu\text{C}$
$I_{RM}$	max. reverse recovery current				11.5	A
$t_{rr}$	reverse recovery time				115	ns
$E_{rec}$	reverse recovery energy				50	$\mu\text{J}$
$R_{thJC}$	thermal resistance junction to case	(per diode)			1.6	K/W
$R_{thCH}$	thermal resistance case to heatsink			0.55		K/W

 $T_C = 25^{\circ}\text{C}$  unless otherwise stated

**Input Rectifier Bridge D8 - D11**

Symbol	Definitions	Conditions	Ratings			Unit
			min.	typ.	max.	
$V_{RRM}$	max. repetitive reverse voltage		$T_{VJ} = 25^{\circ}\text{C}$		1600	V
$I_{FAV}$	average forward current	sine $180^{\circ}$	$T_C = 80^{\circ}\text{C}$		39	A
$I_{DAVM}$	max. average DC output current	rect.; $d = 1/2$	$T_C = 80^{\circ}\text{C}$		42	A
$I_{FSM}$	max. forward surge current	$t = 10$ ms; sine 50 Hz	$T_{VJ} = 25^{\circ}\text{C}$ $T_{VJ} = 125^{\circ}\text{C}$		550 tbd	A A
$I^2t$	$I^2t$ value for fusing	$t = 10$ ms; sine 50 Hz	$T_{VJ} = 25^{\circ}\text{C}$ $T_{VJ} = 125^{\circ}\text{C}$		1270 tbd	$\text{A}^2\text{s}$ $\text{A}^2\text{s}$
$P_{tot}$	total power dissipation		$T_C = 25^{\circ}\text{C}$		100	W
$V_F$	forward voltage	$I_F = 30$ A	$T_{VJ} = 25^{\circ}\text{C}$ $T_{VJ} = 125^{\circ}\text{C}$	1.2 1.3	1.5	V V
$I_R$	reverse current	$V_R = V_{RRM}$	$T_{VJ} = 25^{\circ}\text{C}$ $T_{VJ} = 125^{\circ}\text{C}$	0.3	0.03	mA mA
$R_{thJC}$	thermal resistance junction to case	(per diode)		0.4	1.2	K/W
$R_{thCH}$	thermal resistance case to heatsink	(per diode)				K/W

**Temperature Sensor NTC**

Symbol	Definitions	Conditions	Ratings			Unit
			min.	typ.	max.	
$R_{25}$	resistance		$T_C = 25^{\circ}\text{C}$	4.75	5.0	$5.25$ k $\Omega$
$B_{25/50}$					3375	K

**Module**

Symbol	Definitions	Conditions	Ratings			Unit
			min.	typ.	max.	
$T_{VJ}$	operating temperature		-40		125	$^{\circ}\text{C}$
$T_{VJM}$	max. virtual junction temperature				150	$^{\circ}\text{C}$
$T_{stg}$	storage temperature		-40		125	$^{\circ}\text{C}$
$V_{ISOL}$	isolation voltage	$I_{ISOL} \leq 1$ mA; 50/60 Hz			2500	V~
CTI	comparative tracking index			-		
$F_C$	mounting force		40		80	N
$d_S$	creep distance on surface		12.7			mm
$d_A$	strike distance through air		12			mm
Weight				35		g

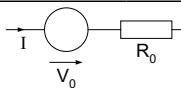
**Equivalent Circuits for Simulation**

Symbol	Definitions	Conditions	Ratings			Unit
			min.	typ.	max.	
$V_0$	rectifier diode	D8 - D11	$T_{VJ} = 125^{\circ}\text{C}$	0.9		V
$R_0$				6		$\text{m}\Omega$
$V_0$	IGBT	T1 - T6	$T_{VJ} = 125^{\circ}\text{C}$	1.15		V
$R_0$				77		$\text{m}\Omega$
$V_0$	free wheeling diode	D1 - D6	$T_{VJ} = 125^{\circ}\text{C}$	1.05		V
$R_0$				30		$\text{m}\Omega$

 $T_C = 25^{\circ}\text{C}$  unless otherwise stated

### Circuit Diagram

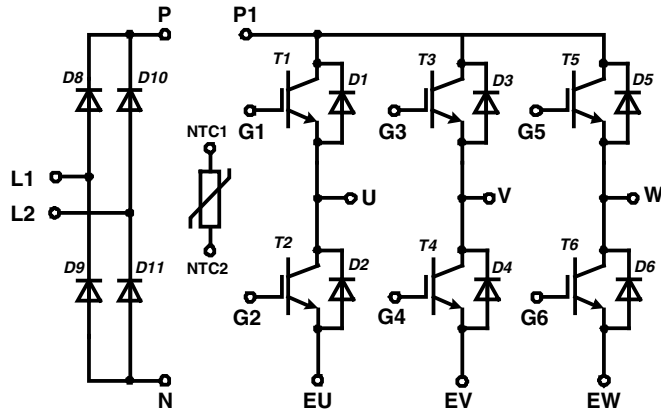

### Outline Drawing

Dimensions in mm (1 mm = 0.0394")

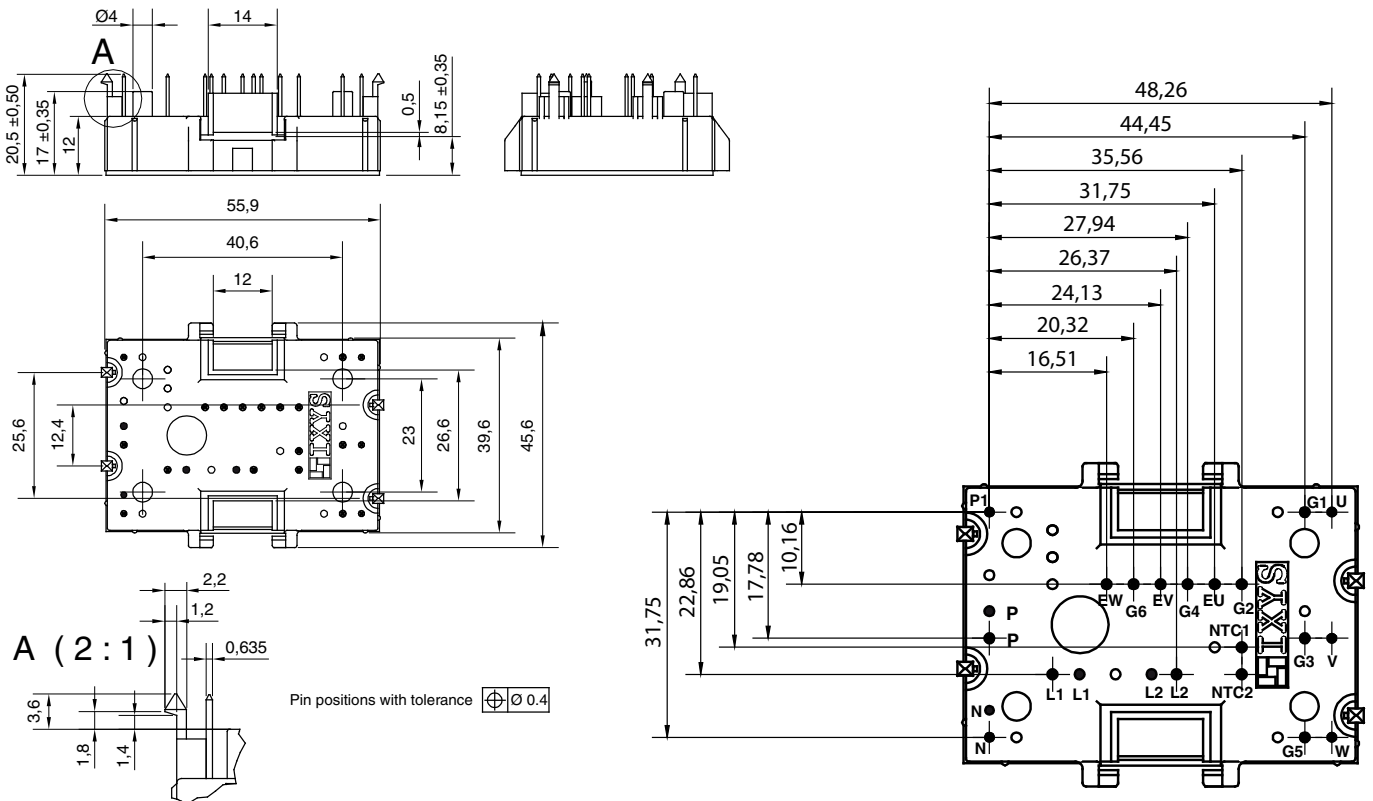

### Product Marking

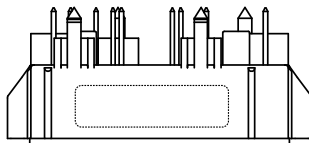

#### Part number

- M = Module
- I = IGBT
- A = IGBT (NPT)
- A = Gen 1 / std
- 15 = Current Rating [A]
- WD = 6-Pack + 1~ Rectifier Bridge
- 600 = Reverse Voltage [V]
- T = NTC
- MH = MiniPack2

Ordering	Part Name	Marking on Product	Delivering Mode	Base Qty	Ordering Code
Standard	MIAA 15 WD 600 TMH	MIAA15WD600TMH	Box	20	504869

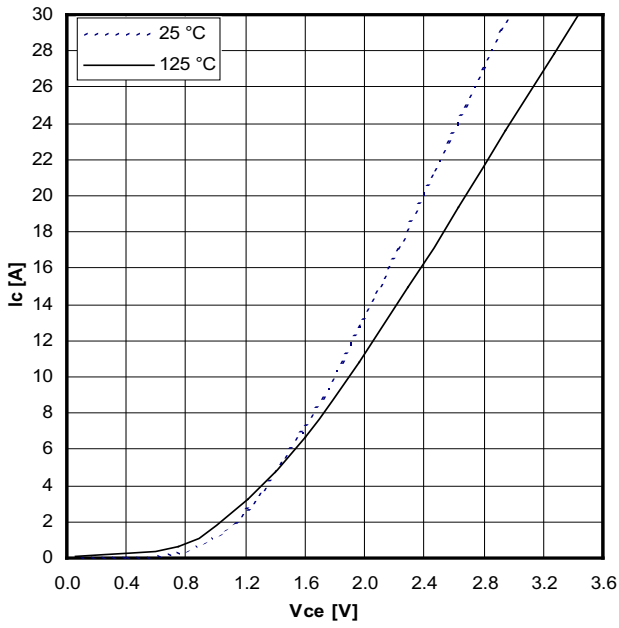

Typical output characteristics,  $V_{GE} = 15\text{ V}$

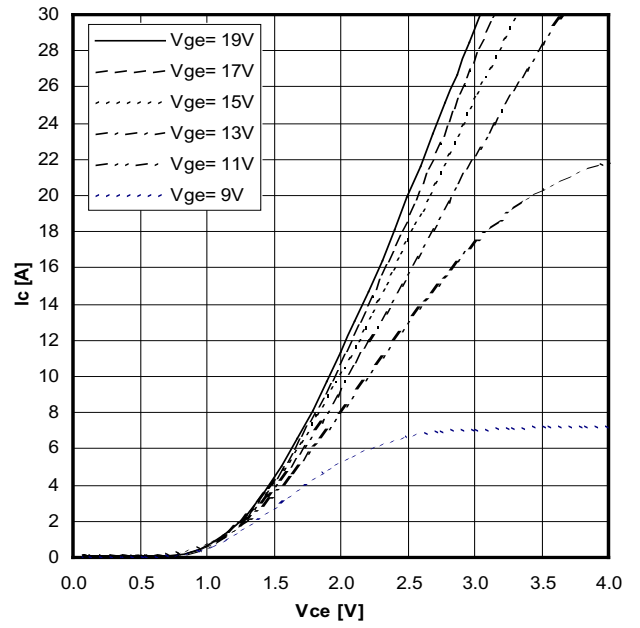

Typical output characteristics ( $125\text{ }^\circ\text{C}$ )

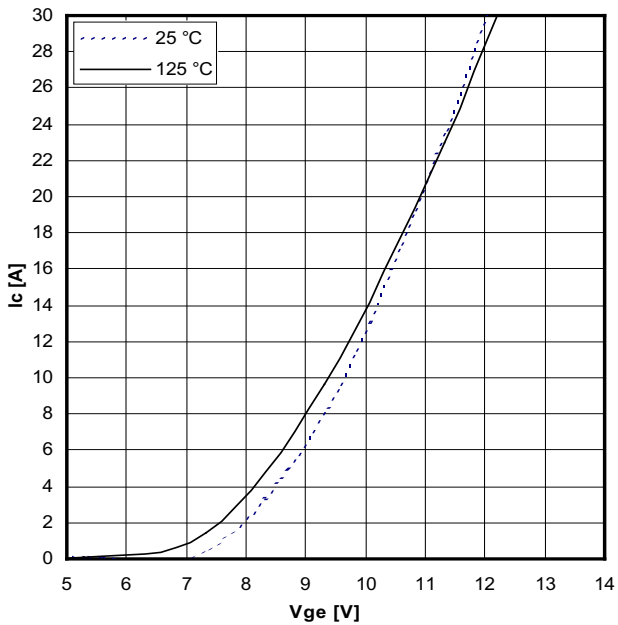

Typical transfer characteristics

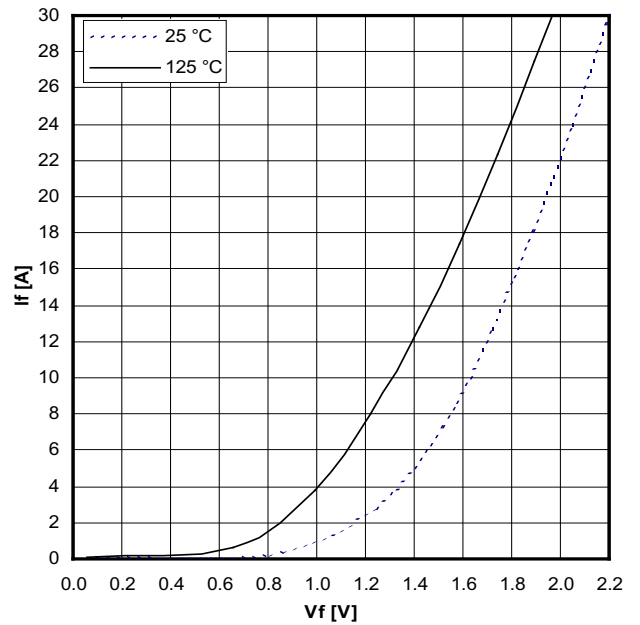

Typical forward characteristics of freewheeling diode

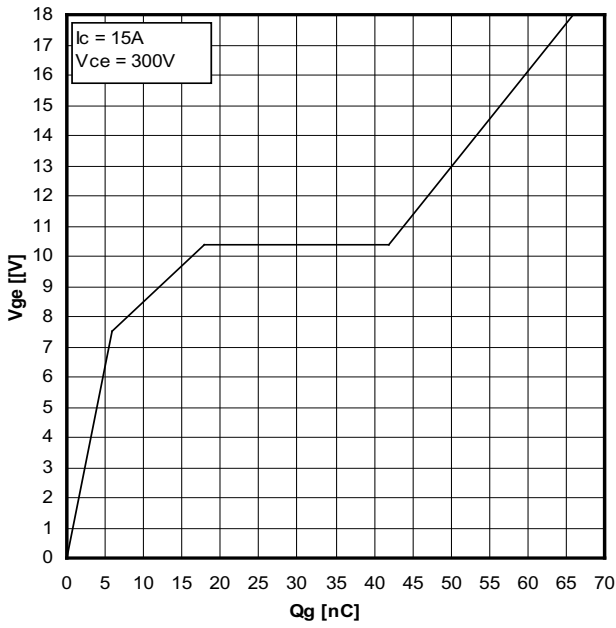

Typical turn on gate charge

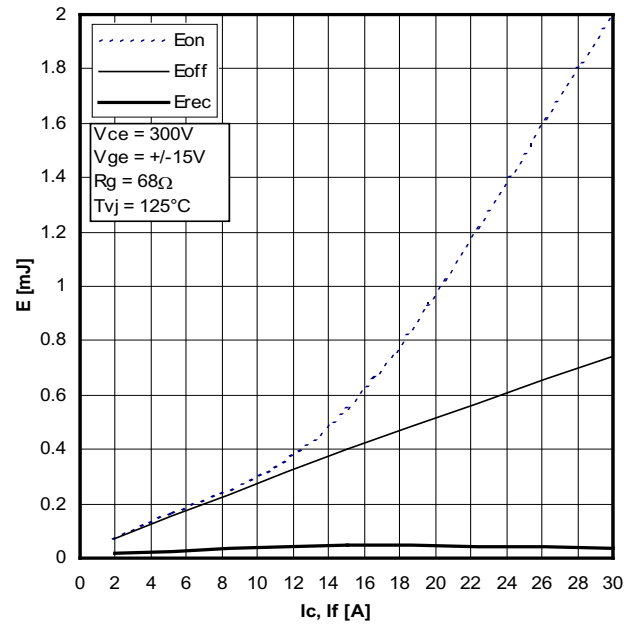

Typical switching energy versus collector current

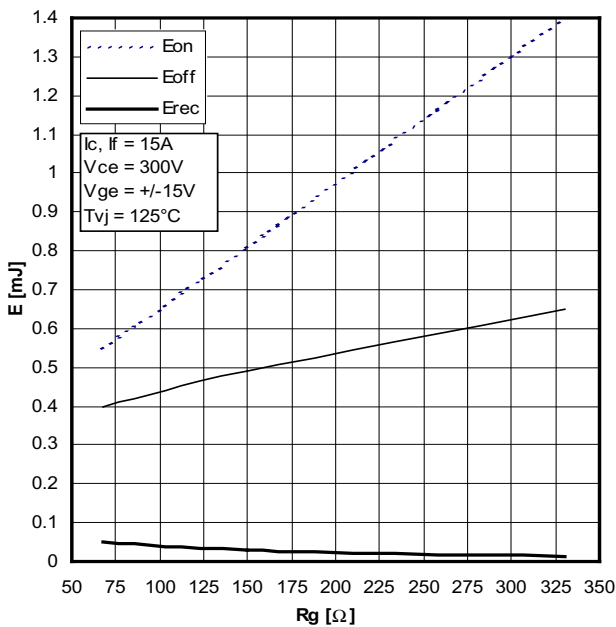

Typical switching energy versus gate resistance

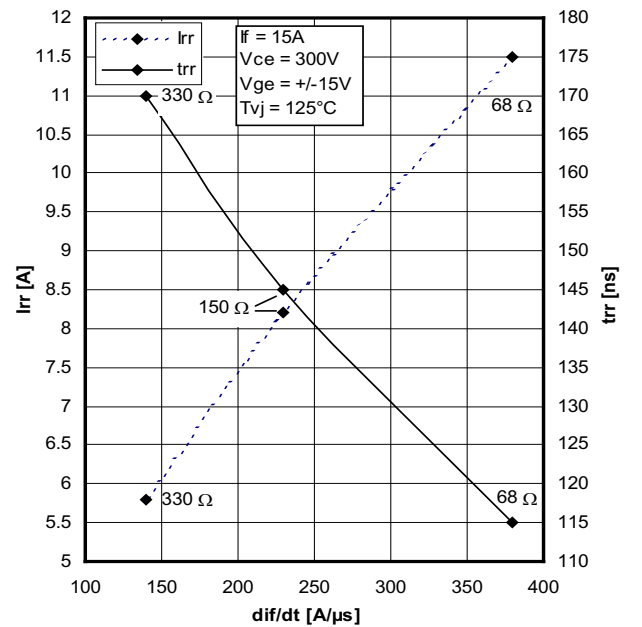

Typical turn-off characteristics of free wheeling diode

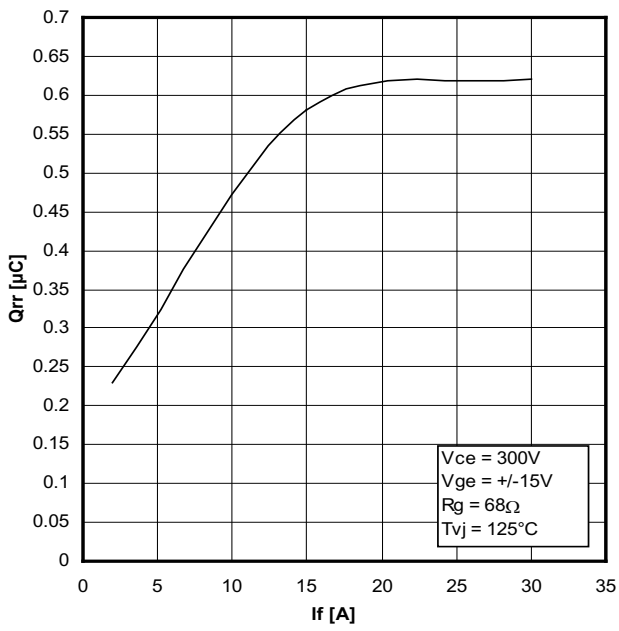

Typical turn-off characteristics of free wheeling diode

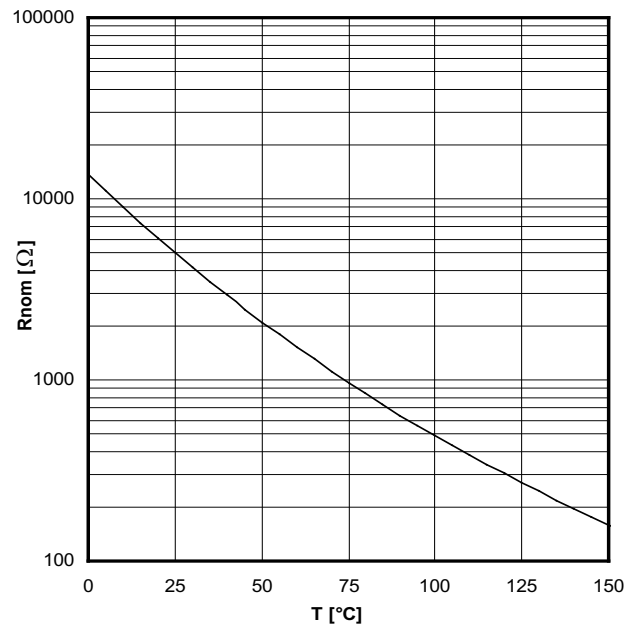

Typical thermistor resistance versus temperature

## Данный компонент на территории Российской Федерации

### Вы можете приобрести в компании MosChip.

Для оперативного оформления запроса Вам необходимо перейти по данной ссылке:

<http://moschip.ru/get-element>

Вы можете разместить у нас заказ для любого Вашего проекта, будь то серийное производство или разработка единичного прибора.

В нашем ассортименте представлены ведущие мировые производители активных и пассивных электронных компонентов.

Нашей специализацией является поставка электронной компонентной базы двойного назначения, продукции таких производителей как XILINX, Intel (ex.ALTERA), Vicor, Microchip, Texas Instruments, Analog Devices, Mini-Circuits, Amphenol, Glenair.

Сотрудничество с глобальными дистрибьюторами электронных компонентов, предоставляет возможность заказывать и получать с международных складов практически любой перечень компонентов в оптимальные для Вас сроки.

На всех этапах разработки и производства наши партнеры могут получить квалифицированную поддержку опытных инженеров.

Система менеджмента качества компании отвечает требованиям в соответствии с ГОСТ Р ИСО 9001, ГОСТ РВ 0015-002 и ЭС РД 009

### Офис по работе с юридическими лицами:

105318, г.Москва, ул.Щербаковская д.3, офис 1107, 1118, ДЦ «Щербаковский»

Телефон: +7 495 668-12-70 (многоканальный)

Факс: +7 495 668-12-70 (доб.304)

E-mail: [info@moschip.ru](mailto:info@moschip.ru)

Skype отдела продаж:

moschip.ru

moschip.ru\_4

moschip.ru\_6

moschip.ru\_9