

150 mA, ultra low quiescent current linear voltage regulator

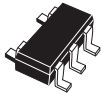

SOT23-5L

Features

- Input voltage from 1.5 to 5.5 V
- Very low quiescent current:
 - 1.0 μA (typ.) at no load
 - 1.4 μA (typ.) at 150 mA load
 - 1 nA (typ.) in OFF mode
 - 200 nA max. in OFF mode at 125 °C
- Output voltage tolerance: $\pm 2\%$ at 25 °C
- 150 mA guaranteed output current
- Wide range of output voltages: 0.8 V to 3.3 V in 100 mV steps
- Logic-controlled electronic shutdown
- Compatible with ceramic capacitor ($C_{\text{OUT}} = 1 \mu\text{F}$)
- Internal current and thermal limit
- Temperature range: from -40 °C to 125 °C

Application

- Mobile phones
- Digital still cameras (DSC)
- Battery-powered equipment
- Portable media players

Maturity status link

STLQ015

Description

The **STLQ015** provides 150 mA of maximum current with an input voltage range from 1.5 V to 5.5 V and a typical dropout voltage of 112 mV. The key feature of this device is its quiescent current, which is just 1.4 μA at maximum output current. The device is stable with a ceramic capacitor on the output. It offers very low quiescent current and extends battery-life of applications requiring very long standby time. The enable logic control function puts the **STLQ015** in shutdown mode, reducing total current consumption to 1 nA. The device also includes short-circuit constant-current limiting and thermal protection. Typical applications are: portable and battery-powered systems, electronic sensors and microcontroller power supply.

1 Block diagram

Figure 1. Device block diagram

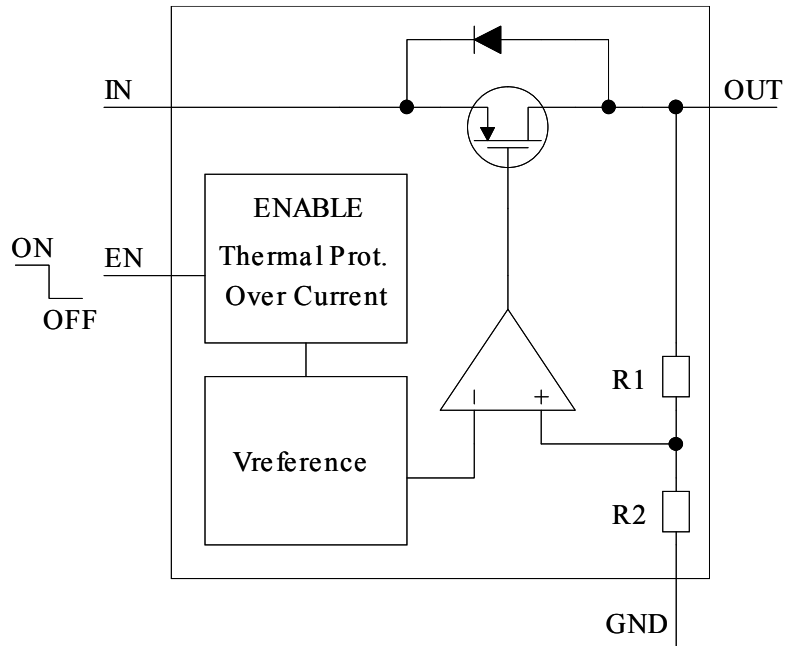

AMG140720160900MT

2 Pin configuration and description

Figure 2. Pin configuration (top view)

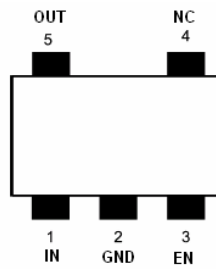

SOT23-5L

AMG140720160901MT

Table 1. Pin description

Pin	Symbol	Functions
3	EN	Enable input Set V_{EN} = high to turn on the device Set V_{EN} = low to turn off the device
2	GND	Ground
1	IN	Input voltage
5	OUT	Output voltage
4	NC	Not connected

3 Typical application

Figure 3. Typical application circuit

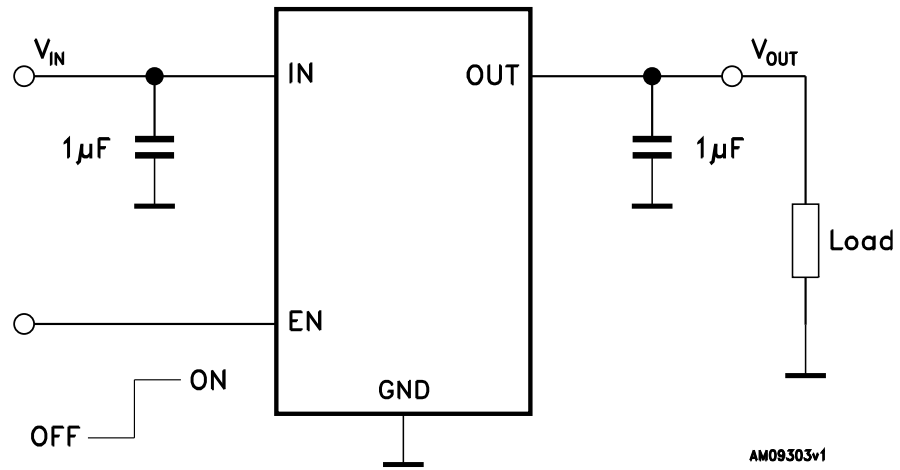

AMG140720160902

4 Maximum ratings

Table 2. Absolute maximum ratings

Symbol	Parameter	Value	Unit
V_{IN}	DC input voltage	-0.3 to 7	V
V_{OUT}	DC output voltage	-0.3 to $V_{IN}+0.3$	V
V_{EN}	Enable input voltage	-0.3 to $V_{IN}+0.3$	V
I_{OUT}	Output current	Internally limited	mA
ESD	Human body model	± 3	kV
	Machine model	± 300	V
P_D	Power dissipation	Internally limited	mW
T_{STG}	Storage temperature range	-65 to 150	$^{\circ}\text{C}$
T_{OP}	Max. junction temperature	150	$^{\circ}\text{C}$

Note: Absolute maximum ratings are those values beyond which damage to the device may occur. Functional operation under these conditions is not implied. All values are referred to GND.

Table 3. Thermal data

Symbol	Parameter	Value	Unit
R_{thJA}	Thermal resistance junction-ambient	255	$^{\circ}\text{C}/\text{W}$
R_{thJC}	Thermal resistance junction-case	81	$^{\circ}\text{C}/\text{W}$

5 Electrical characteristics

$T_J = 25\text{ °C}$, $V_{IN} = V_{OUT(NOM)} + 1\text{ V}$, $C_{IN} = C_{OUT} = 1\text{ }\mu\text{F}$, $I_{OUT} = 1\text{ mA}$, $V_{EN} = V_{IN}$, unless otherwise specified.

Table 4. Electrical characteristics

Symbol	Parameter	Test conditions	Min.	Typ.	Max.	Unit
V_{IN}	Operating input voltage	$I_{OUT} = 0$	1.5		5.5	V
		$-40\text{ °C} < T_J < 125\text{ °C}$, $I_{OUT} = 150\text{ mA}$	1.55		5.5	
V_{OUT}	V_{OUT} accuracy	$I_{OUT} = 1\text{ mA}$	-2		2	%
		$I_{OUT} = 1\text{ mA}$, $V_{OUT} < 1\text{ V}$	-20		+20	mV
		$I_{OUT} = 1\text{ mA}$, $-40\text{ °C} < T_J < 125\text{ °C}$	-3		3	%
$\Delta V_{OUT-LINE}$	Static line regulation	$V_{OUT} + 1\text{ V} \leq V_{IN} \leq 5.5\text{ V}$, $I_{OUT} = 1\text{ mA}$		± 0.01		%/V
$\Delta V_{OUT-LOAD}$	Static load regulation	$I_{OUT} = 1\text{ mA}$ to 150 mA		± 0.002		%/mA
V_{DROP}	Dropout voltage ⁽¹⁾	$I_{OUT} = 150\text{ mA}$		112		mV
		$I_{OUT} = 150\text{ mA}$, $-40\text{ °C} < T_J < 125\text{ °C}$			300	
e_N	Output noise voltage	10 kHz to 100 kHz, $I_{OUT} = 10\text{ mA}$, $V_{OUT} = 0.8\text{ V}$		75		μV_{RMS}
SVR	Supply voltage rejection $V_{OUT} = 0.8\text{ V}$	$V_{IN} = V_{OUTNOM} + 1\text{ V} \pm V_{RIPPLE}$ $V_{RIPPLE} = 0.1\text{ V}$, frequency = 1 kHz $I_{OUT} = 10\text{ mA}$		40		dB
		$V_{IN} = V_{OUTNOM} + 1\text{ V} \pm V_{RIPPLE}$ $V_{RIPPLE} = 0.1\text{ V}$, frequency = 10 kHz $I_{OUT} = 1\text{ mA}$		30		
		$V_{IN} = V_{OUTNOM} + 1\text{ V} \pm V_{RIPPLE}$ $V_{RIPPLE} = 0.1\text{ V}$, frequency = 100 kHz $I_{OUT} = 1\text{ mA}$		15		
I_Q	Quiescent current	$I_{OUT} = 0$		1.0	1.7	μA
		$I_{OUT} = 0$ to 150 mA , $-40\text{ °C} < T_J < 125\text{ °C}$		1.4	2.4	
I_{OFF}	Shutdown current ⁽²⁾	V_{IN} input current in OFF mode: $V_{EN} = \text{GND}$, $-40\text{ °C} < T_J < 125\text{ °C}$		1	200	nA
I_{SC}	Short-circuit current	$R_L = 0$	250	350		mA
V_{EN}	Enable input logic low	$V_{IN} = 1.5\text{ V}$ to 5.5 V			0.4	V
	Enable input logic high	$V_{IN} = 1.5\text{ V}$ to 5.5 V	0.7			V
I_{EN}	Enable pin input current	$V_{EN} = 5.5\text{ V}$		1	200	nA
T_{ON}	Turn-on time ⁽³⁾	$V_{OUT} = 0.8\text{ V}$, $I_{OUT} = 150\text{ mA}$		160		μs
T_{SHDN}	Thermal shutdown			170		$^{\circ}\text{C}$
	Hysteresis			15		

Symbol	Parameter	Test conditions	Min.	Typ.	Max.	Unit
C _{OUT}	Output capacitor	Capacitance (see typical performance characteristics for stability)	0.47		10	μF
	ESR		0.056		6	Ω

1. Dropout voltage is the input-to-output voltage difference at which the output voltage is 100 mV below its nominal value. This specification does not apply to output voltages below 1.5 V.
2. During shutdown and at no load, P-channel leakage current flowing through the internal resistor divider causes the V_{OUT} rise.
3. Turn-on time is the time measured between the enable input just exceeding V_{EN} high value and the output voltage just reaching 95% of its nominal value.

6 Typical performance characteristics

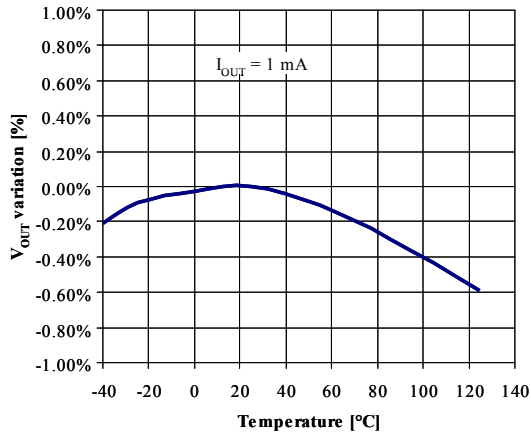
Figure 4. Output voltage vs. temperature

AMG140720161100M

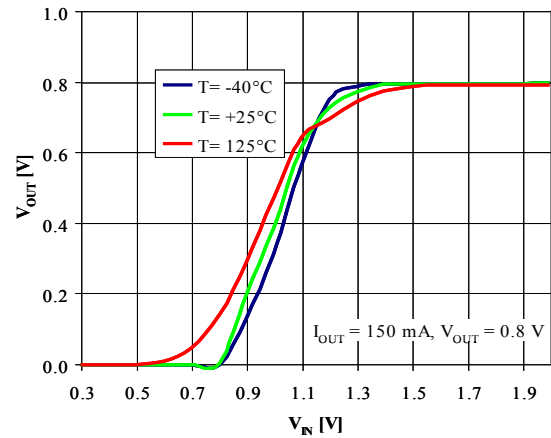
Figure 5. Output voltage vs. input voltage ($V_{OUT} = 0.8 \text{ V}$)

AMG140720161101M

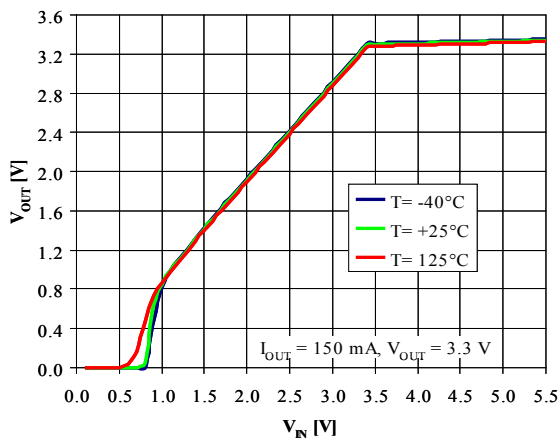
Figure 6. Output voltage vs. input voltage ($V_{OUT} = 3.3 \text{ V}$)

AMG140720161102M

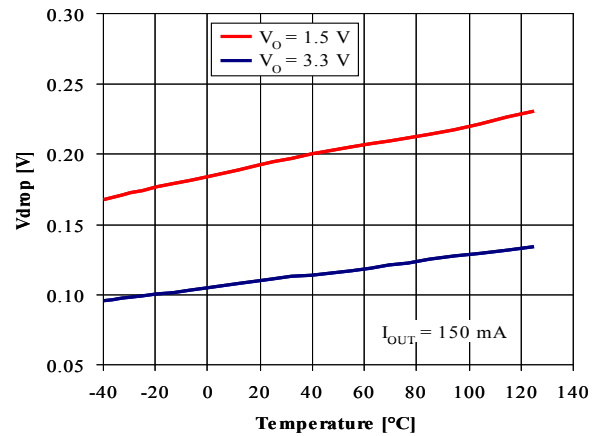
Figure 7. Dropout voltage vs. temperature

AMG140720161103M

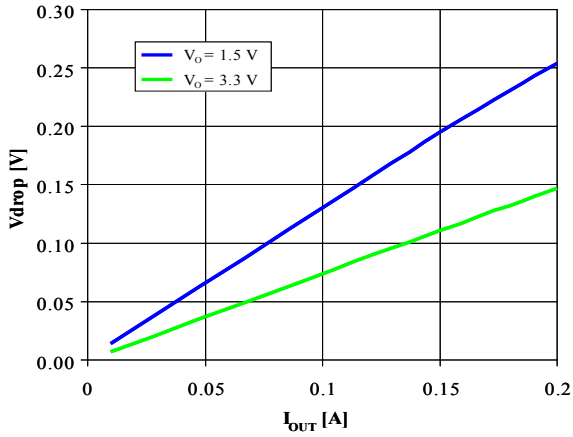
Figure 8. Dropout voltage vs. temperature

AMG140720161104M

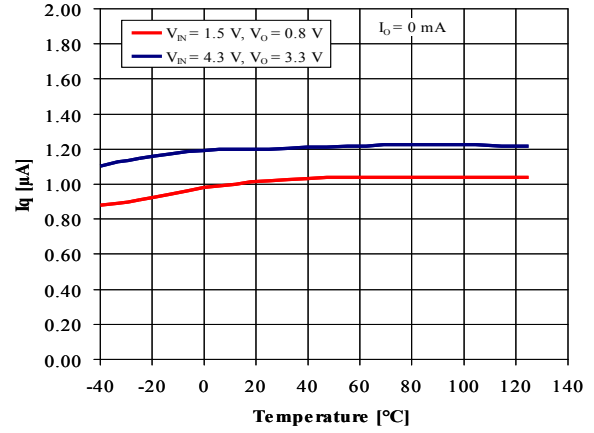
Figure 9. Quiescent current vs. temperature

AMG140720161105M

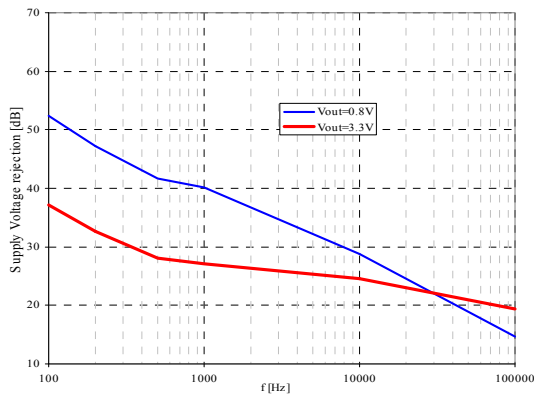
Figure 10. Supply voltage rejection vs. frequency

AMG190720161100M

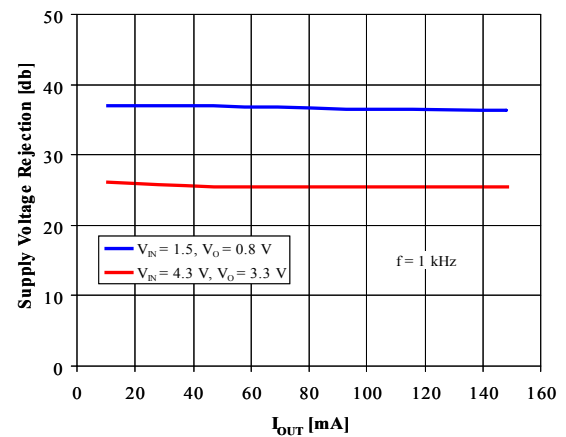
Figure 11. Supply voltage rejection vs. IOUT

AMG190720161101M

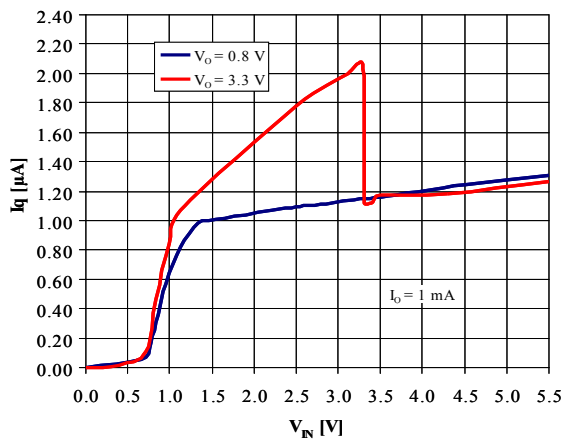
Figure 12. Quiescent current vs. input voltage

AMG190720161102M

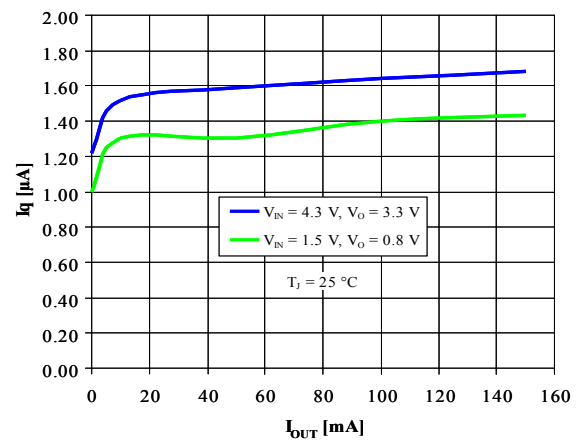
Figure 13. Quiescent current vs. output current

AMG190720161103M

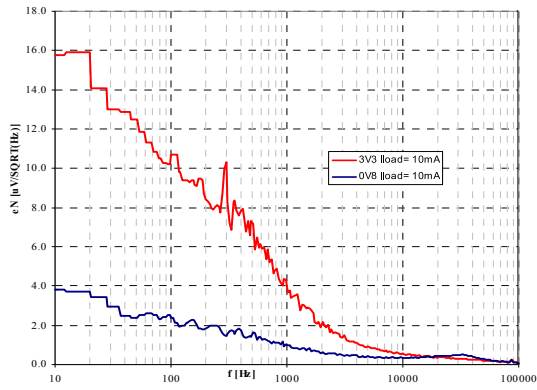
Figure 14. Output noise voltage vs. frequency

AMG190720161104M

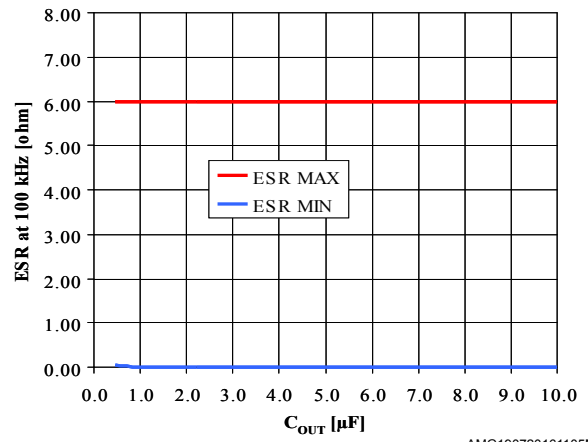
Figure 15. C_{OUT} stability region

AMG190720161105M

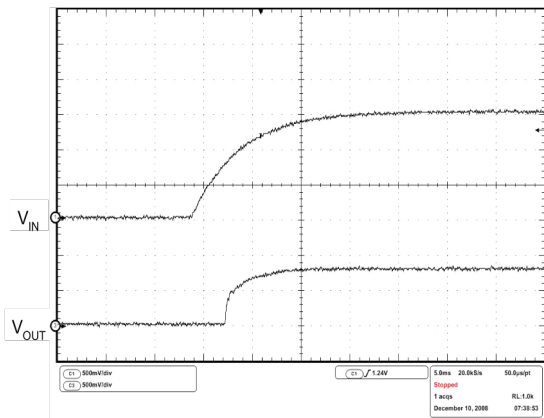
Figure 16. Start-up transient

 V_{IN} from 0 to 1.5 V, V_{EN} tied to V_{IN} , no load $C_{OUT} = 1 \mu\text{F}$

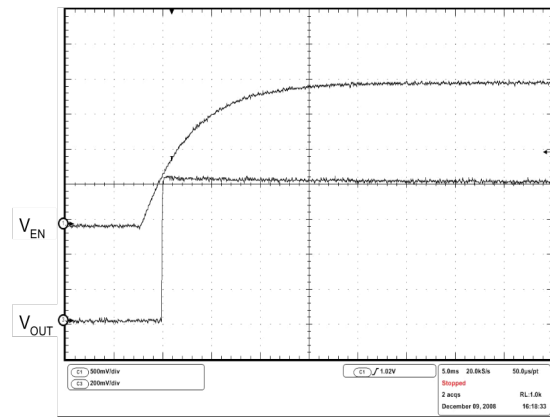
AMG190720161106M

Figure 17. Enable transient

 $V_{IN} = 1.5 \text{ V}$; V_{EN} from 0 to 2 V, no load, $T = 25 \text{ }^\circ\text{C}$

AMG190720161107M

7 Package information

In order to meet environmental requirements, ST offers these devices in different grades of **ECOPACK** packages, depending on their level of environmental compliance. ECOPACK specifications, grade definitions and product status are available at: www.st.com. ECOPACK is an ST trademark.

7.1 SOT23-5L mechanical data

Figure 18. SOT23-5L package outline

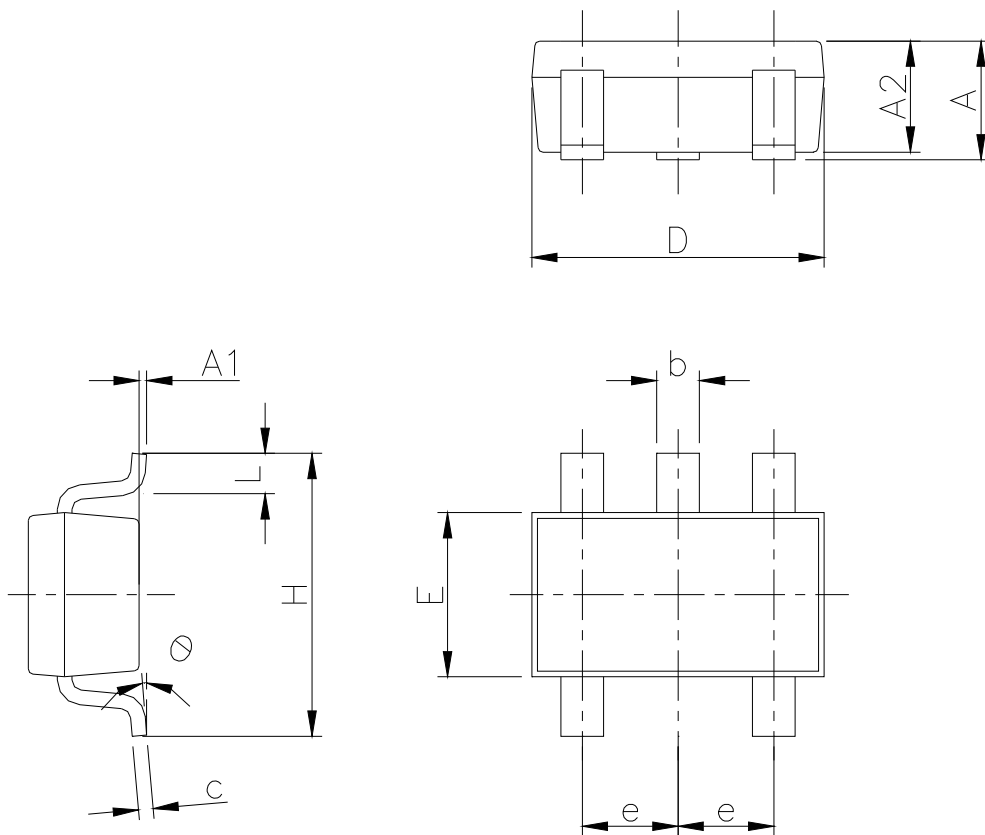

7049676_k

Table 5. SOT23-5L package mechanical data

Dim.	mm		
	Min.	Typ.	Max.
A	0.90		1.45
A1	0		0.15
A2	0.90		1.30
b	0.30		0.50
c	0.09		0.20
D		2.95	
E		1.60	
e		0.95	
H		2.80	
L	0.30		0.60
θ	0°		8°

Figure 19. SOT23-5L recommended footprint

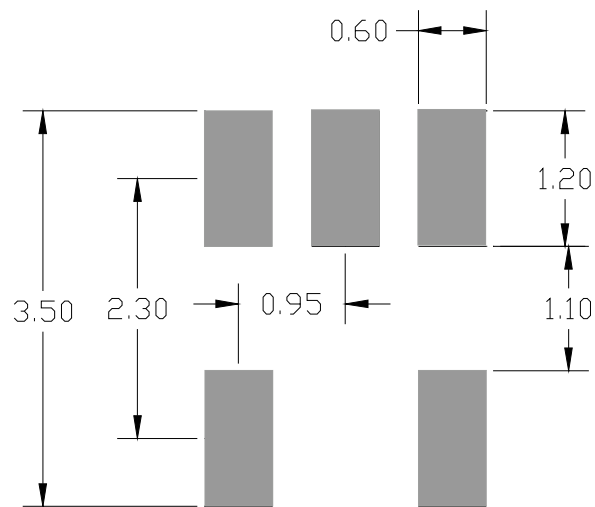

Note: Dimensions are in mm

7.2 SOT23-5L packing information

Figure 20. SOT23-5L tape and reel outline

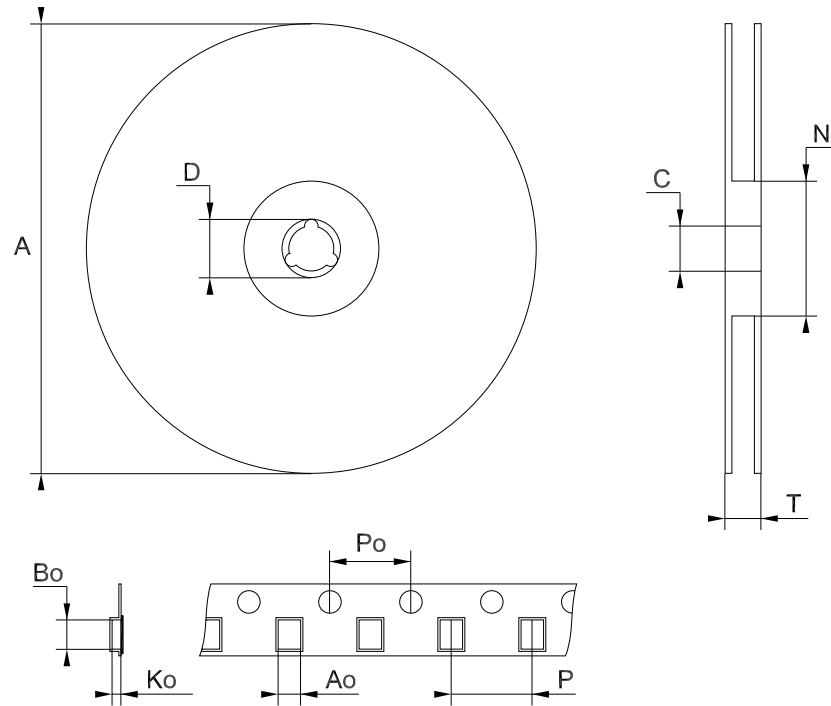

Note: Drawing not in scale

Table 6. SOT23-5L tape and reel mechanical data

Dim.	mm		
	Min.	Typ.	Max.
A			180
C	12.8	13.0	13.2
D	20.2		
N	60		
T			14.4
Ao	3.13	3.23	3.33
Bo	3.07	3.17	3.27
Ko	1.27	1.37	1.47
Po	3.9	4.0	4.1
P	3.9	4.0	4.1

8 Ordering information

Table 7. Order code

Order code	Output voltage	Package	Marking
STLQ015M12R	1.2 V	SOT23-5L	1512
STLQ015M15R	1.5 V		1515
STLQ015M18R	1.8 V		1518
STLQ015M20R	2.0 V		1520
STLQ015M21R	2.1 V		1521
STLQ015M25R	2.5 V		1525
STLQ015M28R	2.8 V		1528
STLQ015M30R	3.0 V		1530
STLQ015M31R	3.1 V		1531
STLQ015M33R	3.3 V		1533

Revision history

Table 8. Document revision history

Date	Revision	Changes
23-Mar-2010	1	Initial release.
20-Jan-2011	2	Modified: Table 5 on page 13 and Figure 18. Added: Figure 19.
11-Sep-2012	3	Added: new order codes STLQ015XG12R, STLQ015XG15R and STLQ015XG18R to the device summary table.
17-Feb-2014	4	Changed the part number STLQ015xx to STLQ015. Changed the title in cover page. Updated Description and Table : in cover page. Changed typ. value of I_Q parameter in Table 4: Electrical characteristics. Minor text changes.
03-Jul-2015	5	Added package SOT23-5L. Updated Table 1.: Pin description, Table 3.: Thermal data and Figure 2.: Pin configuration (top view) Updated 8: Order code. Updated Section 7: Package information. Minor text changes.
02-Sep-2016	6	Updated Section 8: "Ordering information". Minor text changes.
14-Feb-2020	7	Added new part number STLQ015M20R in Table 7 .

Contents

1	Block diagram	2
2	Pin configuration and description	3
3	Typical application	4
4	Maximum ratings	5
5	Electrical characteristics	6
6	Typical performance characteristics	8
7	Package information	11
	7.1 SOT23-5L package information	11
	7.2 SOT23-5L packing information	12
8	Ordering information	14
	Revision history	15
	Contents	16
	List of tables	17
	List of figures	18
	@NA	19

List of tables

Table 1.	Pin description	3
Table 2.	Absolute maximum ratings	5
Table 3.	Thermal data	5
Table 4.	Electrical characteristics	6
Table 5.	SOT23-5L package mechanical data	12
Table 6.	SOT23-5L tape and reel mechanical data	13
Table 7.	Order code	14
Table 8.	Document revision history	15

List of figures

Figure 1.	Device block diagram	2
Figure 2.	Pin configuration (top view)	3
Figure 3.	Typical application circuit	4
Figure 4.	Output voltage vs. temperature	8
Figure 5.	Output voltage vs. input voltage ($V_{OUT} = 0.8\text{ V}$).	8
Figure 6.	Output voltage vs. input voltage ($V_{OUT} = 3.3\text{ V}$).	8
Figure 7.	Dropout voltage vs. temperature	8
Figure 8.	Dropout voltage vs. temperature	9
Figure 9.	Quiescent current vs. temperature.	9
Figure 10.	Supply voltage rejection vs. frequency	9
Figure 11.	Supply voltage rejection vs. I_{OUT}	9
Figure 12.	Quiescent current vs. input voltage	9
Figure 13.	Quiescent current vs. output current	9
Figure 14.	Output noise voltage vs. frequency	10
Figure 15.	C_{OUT} stability region	10
Figure 16.	Start-up transient	10
Figure 17.	Enable transient	10
Figure 18.	SOT23-5L package outline.	11
Figure 19.	SOT23-5L recommended footprint	12
Figure 20.	SOT23-5L tape and reel outline	13

IMPORTANT NOTICE – PLEASE READ CAREFULLY

STMicroelectronics NV and its subsidiaries (“ST”) reserve the right to make changes, corrections, enhancements, modifications, and improvements to ST products and/or to this document at any time without notice. Purchasers should obtain the latest relevant information on ST products before placing orders. ST products are sold pursuant to ST’s terms and conditions of sale in place at the time of order acknowledgement.

Purchasers are solely responsible for the choice, selection, and use of ST products and ST assumes no liability for application assistance or the design of Purchasers’ products.

No license, express or implied, to any intellectual property right is granted by ST herein.

Resale of ST products with provisions different from the information set forth herein shall void any warranty granted by ST for such product.

ST and the ST logo are trademarks of ST. For additional information about ST trademarks, please refer to www.st.com/trademarks. All other product or service names are the property of their respective owners.

Information in this document supersedes and replaces information previously supplied in any prior versions of this document.

© 2020 STMicroelectronics – All rights reserved

Данный компонент на территории Российской Федерации

Вы можете приобрести в компании MosChip.

Для оперативного оформления запроса Вам необходимо перейти по данной ссылке:

<http://moschip.ru/get-element>

Вы можете разместить у нас заказ для любого Вашего проекта, будь то серийное производство или разработка единичного прибора.

В нашем ассортименте представлены ведущие мировые производители активных и пассивных электронных компонентов.

Нашей специализацией является поставка электронной компонентной базы двойного назначения, продукции таких производителей как XILINX, Intel (ex.ALTERA), Vicor, Microchip, Texas Instruments, Analog Devices, Mini-Circuits, Amphenol, Glenair.

Сотрудничество с глобальными дистрибьюторами электронных компонентов, предоставляет возможность заказывать и получать с международных складов практически любой перечень компонентов в оптимальные для Вас сроки.

На всех этапах разработки и производства наши партнеры могут получить квалифицированную поддержку опытных инженеров.

Система менеджмента качества компании отвечает требованиям в соответствии с ГОСТ Р ИСО 9001, ГОСТ РВ 0015-002 и ЭС РД 009

Офис по работе с юридическими лицами:

105318, г.Москва, ул.Щербаковская д.3, офис 1107, 1118, ДЦ «Щербаковский»

Телефон: +7 495 668-12-70 (многоканальный)

Факс: +7 495 668-12-70 (доб.304)

E-mail: info@moschip.ru

Skype отдела продаж:

moschip.ru

moschip.ru_4

moschip.ru_6

moschip.ru_9