

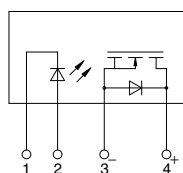

**Max. high capacity 10A
in a slim SIL package**

**PhotoMOS®
Power 1 Form A
DC High Capacity (AQZ19○)**

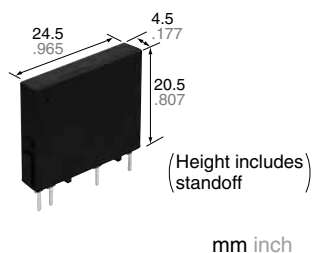

RoHS compliant

FEATURES

- 1. High capacity type power PhotoMOS.**
Can switch a wide range of currents and voltages. Can control various types of loads, from very small loads to a max. 10 A DC current for sequencers, motors, and lamps.
- 2. Low on-resistance and high sensitivity.**
Low on-resistance of less than Typ. 8 mΩ (AQZ192). High sensitivity LED operate current of Typ. 0.7 mA.
- 3. 4-pin SIL type (Thickness: Max. 4.5 mm .177 inch)**
(L) 24.5 mm × (W) 4.5 mm × (H) 20.5 mm
(L) .965 inch × (W) .177 inch × (H) .807 inch.
- 4. Low-level off state leakage current of max. 10 μA**
- 5. Controls low-level analog signals**
The triac, photocoupler, or SSR cannot be used to control signals of less than several hundred mV. The high capacity type power PhotoMOS feature extremely low closed-circuit offset voltage to enable control of low-level analog signals without distortion.

TYPICAL APPLICATIONS

- Photovoltaic power generation system
- Battery system
- Measuring instruments
- Power supply unit
- Industrial machines

TYPES

	Output rating*		Package	Part No.	Packing quantity	
	Load voltage	Load current			Inner carton	Outer carton
DC only	60 V	10 A	SIL4-pin	AQZ192	20 pcs	500 pcs
	200 V	5 A		AQZ197		

Note: Please refer to the cautions for use regarding the recommended operation load voltage.

*Load voltage and load current of DC type: DC

RATING

1. Absolute maximum ratings (Ambient temperature: 25°C 77°F)

Item		Symbol	AQZ192	AQZ197	Remarks
Input	LED forward current	I _F	50 mA		
	LED reverse voltage	V _R	5 V		
	Peak forward current	I _{FP}	1 A		f = 100Hz, Duty factor = 0.1%
	Power dissipation	P _{in}	75 mW		
Output	Load voltage (DC)	V _L	60 V	200 V	
	Continuous load current (DC)	I _L	10 A	5 A	
	Peak load current	I _{peak}	30 A	15 A	100 ms (1shot), V _L = DC
	Power dissipation	P _{out}	2.0 W		
Total power dissipation		P _T	2.0 W		
I/O isolation voltage		V _{iso}	3,000 Vrms		
Ambient temperature	Operating	T _{opr}	-40 to +85°C -40 to +185°F		(Non-icing at low temperatures)
	Storage	T _{stg}	-40 to +100°C -40 to +212°F		

Power 1 Form A DC High Capacity (AQZ19)

2. Electrical characteristics (Ambient temperature: 25°C 77°F)

Item		Symbol	AQZ192	AQZ197	Condition
Input	LED operate current	Typical	0.7 mA		$I_L = 100 \text{ mA}$ $V_L = 10 \text{ V}$
		Maximum	3.0 mA		
	LED turn off current	Minimum	0.2 mA		
		Typical	0.5 mA		
LED dropout voltage	Typical	1.35 V (1.17 V at $I_F = 10 \text{ mA}$)		$I_F = 50 \text{ mA}$	
	Maximum	1.5 V			
Output	On resistance	Typical	8 mΩ	31 mΩ	$I_F = 10 \text{ mA}$, $I_L = \text{Max.}$ Within 1 s
		Maximum	15 mΩ	50 mΩ	
	Off state leakage current	Maximum	10 μA		$I_F = 0 \text{ mA}$, $V_L = \text{Max.}$
Transfer characteristics	Turn on time*	Typical	1.0 ms	0.7 ms	$I_F = 10 \text{ mA}$, $I_L = 100 \text{ mA}$, $V_L = 10 \text{ V}$
		Maximum	3.0 ms		
	Turn off time*	Typical	0.11 ms	0.05 ms	$I_F = 10 \text{ mA}$, $I_L = 100 \text{ mA}$, $V_L = 10 \text{ V}$
		Maximum	1.0 ms		
	I/O capacitance	Typical	1.3 pF		$f = 1 \text{ MHz}$, $V_B = 0 \text{ V}$
		Maximum	3.0 pF		
Initial I/O isolation resistance	Minimum	R_{iso}	1,000 MΩ		500 V DC
Max. operating frequency	Maximum	—	0.5 cps		$I_F = 10 \text{ mA}$, Duty factor = 50%, $V_L = \text{Max.}$, $I_L = \text{Max.}$

*Turn on/off time

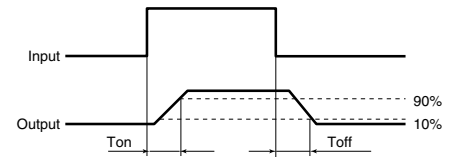

3. Recommended operating conditions (Ambient temperature: 25°C 77°F)

Please use under recommended operating conditions to obtain expected characteristics.

Item		Symbol	Min.	Max.	Unit
LED current		I_F	10	30	mA
AQZ192	Load voltage (Peak AC)	V_L	—	48	V
	Continuous load current	I_L	—	10	A
AQZ197	Load voltage (Peak AC)	V_L	—	160	V
	Continuous load current	I_L	—	5	A

■ These products are not designed for automotive use.

If you are considering to use these products for automotive applications, please contact your local Panasonic Corporation technical representative.

REFERENCE DATA

1. Load current vs. ambient temperature characteristics

Allowable ambient temperature: -40 to +85°C
-40 to +185°F

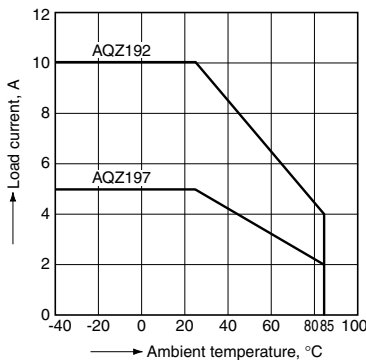

2. Load current vs. ambient temperature characteristics in adjacent mounting

Sample: All types
 I_L : Load current;
 I_L (max.): Maximum continuous load current

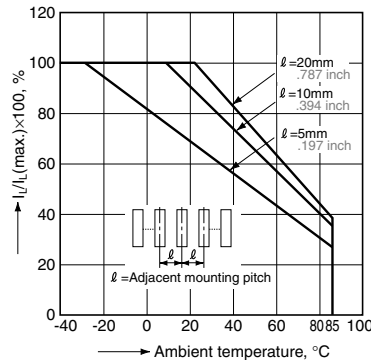

3. On resistance vs. ambient temperature characteristics

LED current: 10 mA;
Continuous load current: 10 A DC (AQZ192)
5 A DC (AQZ197)

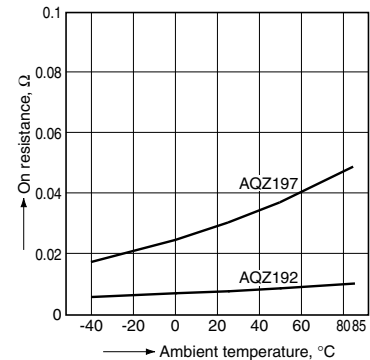

4. Turn on time vs. ambient temperature characteristics

LED current: 10 mA; Load voltage: 10 V (DC);
Continuous load current: 100 mA (DC)

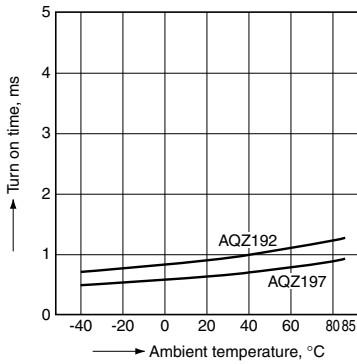

5. Turn off time vs. ambient temperature characteristics

LED current: 10 mA; Load voltage: 10 V (DC);
Continuous load current: 100 mA (DC)

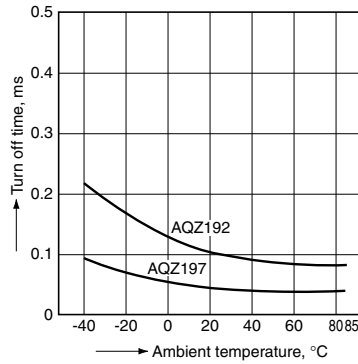

6. LED operate current vs. ambient temperature characteristics

Sample: All types
Load voltage: 10 V (DC);
Continuous load current: 100 mA (DC)

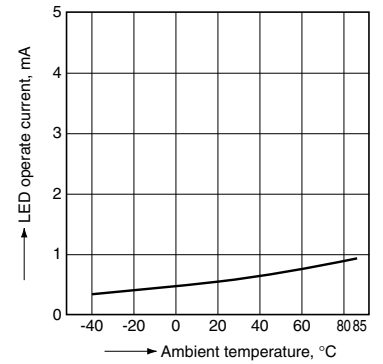

7. LED turn off current vs. ambient temperature characteristics

Sample: All types
Load voltage: 10 V (DC);
Continuous load current: 100 mA (DC)

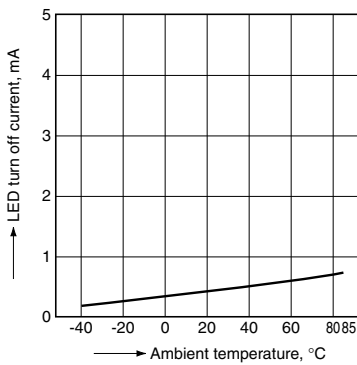

8. LED dropout voltage vs. ambient temperature characteristics

Sample: All types
LED current: 5 to 50 mA

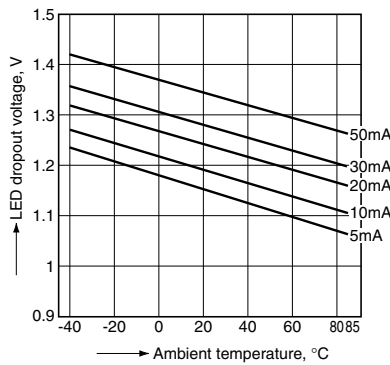

9. Current vs. voltage characteristics of output at MOS portion

Ambient temperature: 25°C 77°F

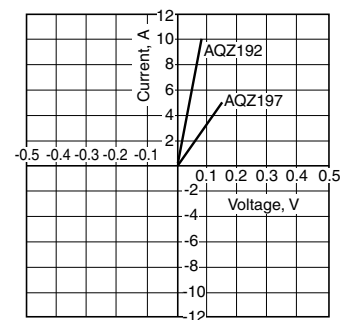

10. Off state leakage current vs. load voltage characteristics

Ambient temperature: 25°C 77°F

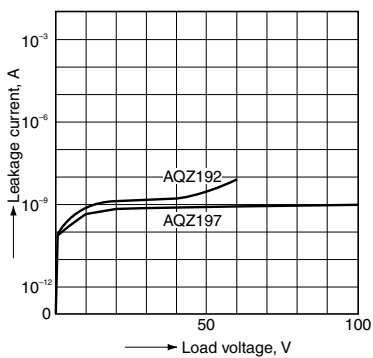

11. Turn on time vs. LED forward current characteristics

Load voltage: 10 V (DC);
Continuous load current: 100 mA (DC);
Ambient temperature: 25°C 77°F

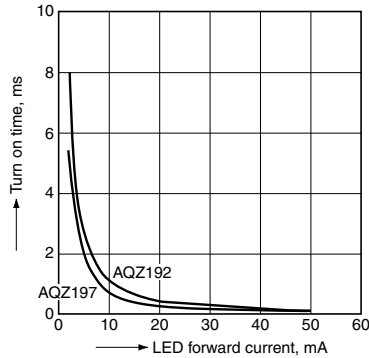

12. Turn off time vs. LED forward current characteristics

Load voltage: 10 V (DC);
Continuous load current: 100 mA (DC);
Ambient temperature: 25°C 77°F

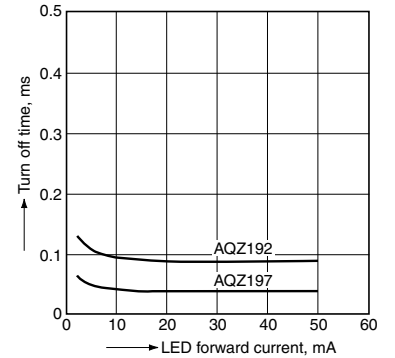

Power 1 Form A DC High Capacity (AQZ19)

13. Max. operating frequency vs. load voltage/current characteristics

Sample: All types; LED current: 10 mA;
Ambient temperature: 25°C 77°F

V_L : Load voltage, V_L (Max.): Max. rated load voltage
 I_L : Load current, I_L (Max.): Max. rated continuous load current

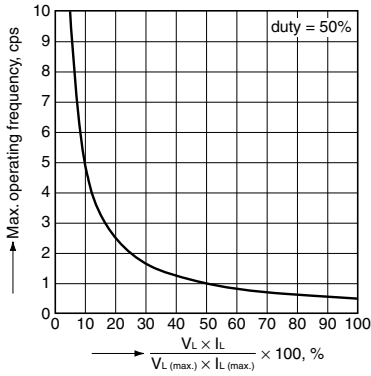

14. Output capacitance vs. applied voltage characteristics

Frequency: 1 MHz; Ambient temperature: 25°C 77°F

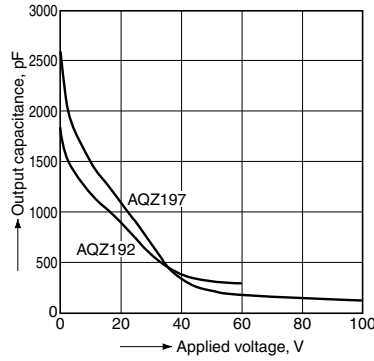

DIMENSIONS (mm inch)



The CAD data of the products with a **CAD** mark can be downloaded from: <http://industrial.panasonic.com/ac/e/>

External dimensions

PC board pattern (Bottom view)

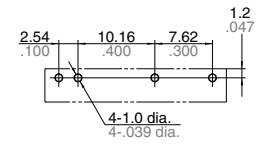
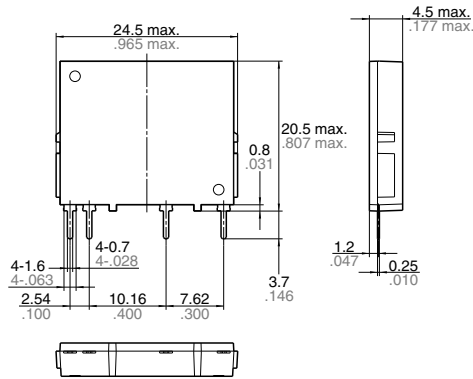

Tolerance: $\pm 0.1 \pm 0.004$

Schematic

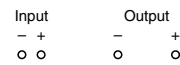

General tolerance: $\pm 0.2 \pm 0.008$

"PhotoMOS®", "PhotoMOS" and "PHOTOMOS" are registered trademarks of Panasonic Corporation.

*Recognized in Japan, the United States, all member states of European Union and other countries.

Please contact

Panasonic Corporation

Electromechanical Control Business Division

■ 1006, Oaza Kadoma, Kadoma-shi, Osaka 571-8506, Japan
industrial.panasonic.com/ac/e/

Panasonic®

©Panasonic Corporation 2017

Mouser Electronics

Authorized Distributor

Click to View Pricing, Inventory, Delivery & Lifecycle Information:

[Panasonic:](#)

[AQZ197](#)

Данный компонент на территории Российской Федерации

Вы можете приобрести в компании MosChip.

Для оперативного оформления запроса Вам необходимо перейти по данной ссылке:

<http://moschip.ru/get-element>

Вы можете разместить у нас заказ для любого Вашего проекта, будь то серийное производство или разработка единичного прибора.

В нашем ассортименте представлены ведущие мировые производители активных и пассивных электронных компонентов.

Нашей специализацией является поставка электронной компонентной базы двойного назначения, продукции таких производителей как XILINX, Intel (ex.ALTERA), Vicor, Microchip, Texas Instruments, Analog Devices, Mini-Circuits, Amphenol, Glenair.

Сотрудничество с глобальными дистрибьюторами электронных компонентов, предоставляет возможность заказывать и получать с международных складов практически любой перечень компонентов в оптимальные для Вас сроки.

На всех этапах разработки и производства наши партнеры могут получить квалифицированную поддержку опытных инженеров.

Система менеджмента качества компании отвечает требованиям в соответствии с ГОСТ Р ИСО 9001, ГОСТ РВ 0015-002 и ЭС РД 009

Офис по работе с юридическими лицами:

105318, г.Москва, ул.Щербаковская д.3, офис 1107, 1118, ДЦ «Щербаковский»

Телефон: +7 495 668-12-70 (многоканальный)

Факс: +7 495 668-12-70 (доб.304)

E-mail: info@moschip.ru

Skype отдела продаж:

moschip.ru

moschip.ru_4

moschip.ru_6

moschip.ru_9