

Powered by



HR 12120W ▶ 12V 120W

HR 12120W is specially designed for high efficient discharge application. Its characteristics are high energy density, small footprint and high discharge efficiency. It can be used for more than 260 cycles at 100% discharge in cycle service, up to 5 years in standby service.



MH14533(N)



No.:041005117



NO.UM 1-12-0045

CSB-manufactured VRLA batteries are UL-recognized components under UL924 and UL1989.

CSB is also certified by ISO 9001 and ISO 14001.

Specification

Cells Per Unit	6
Voltage Per Unit	12
Capacity	120 W @ 15min-rate to 1.67V per cell @25 °C (77°F) 30 Ah @ 20hr-rate to 1.75V per cell @25 °C (77°F)
Weight	Approx. 10.2 kg(22.49 lbs)
Maximum Discharge Current	400A(5sec)
Internal Resistance	Approx. 9 m Ω
Operating Temperature Range	Discharge: -15°C~50°C (5°F~122°F) Charge: -15 °C~40°C (5°F~104°F) Storage: -15°C~40°C (5°F~104°F)
Nominal Operating Temperature Range	25°C±3°C(77°F±5°F)
Float Charging Voltage	13.5 to 13.8 VDC/unit Average at 25°C(77°F)
Recommended Maximum Charging Current Limit	12A
Equalization and Cycle Service	14.4 to 15.0 VDC/unit Average at 25°C(77°F)
Self Discharge	CSB Batteries can be stored for more than 6 months at 25°C(77°F). Please charge batteries before using. For higher temperatures the time interval will be shorter.
Terminal	I1-Thread lead alloy recessed terminal to accept M5 bolt
Container Material	ABS(UL 94-HB/File E50263)*Flammability resistance of (UL 94-V0/File E88637) can be available upon request.

Dimensions :

Unit: mm (inch)	Overall Height (H)	Container height (h)	Length (L)	Width (W)
	175±2 (6.89±0.08)	166.5±2 (6.55±0.08)	166±2 (6.53±0.08)	125±1.5 (4.92±0.06)

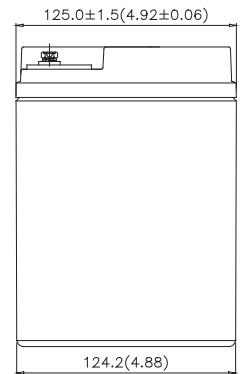
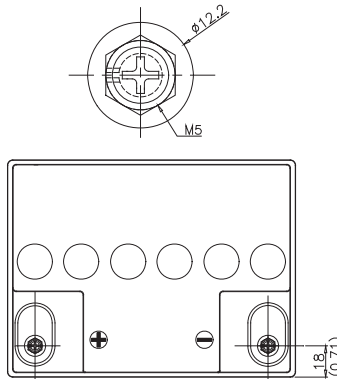
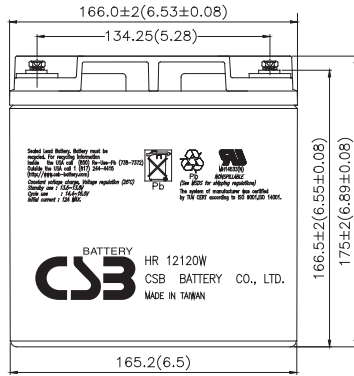

Constant Current Discharge Characteristics Unit:A (25°C, 77°F)

F.V/Time	2MIN	4MIN	6MIN	8MIN	10MIN	15MIN	20MIN	30MIN	60MIN	90MIN
1.60V	169	148	125	107	94.2	70.5	56.1	41.2	24.5	16.8
1.67V	153	135	115	100	88.9	67.0	53.6	39.7	24.0	16.6
1.70V	146	128	109	95.5	85.6	65.3	52.5	39.2	23.7	16.4
1.75V	132	117	101	88.9	80.2	62.0	50.4	37.8	23.1	16.2
1.80V	117	105	91.2	81.3	73.3	58.3	48.0	36.0	22.2	15.8
1.85V	100	92.5	82.4	74.3	67.3	54.3	45.7	34.6	21.2	15.2

Constant Power Discharge Characteristics Unit:W (25°C, 77°F)

F.V/Time	2MIN	4MIN	6MIN	8MIN	10MIN	15MIN	20MIN	30MIN	60MIN	90MIN
1.60V	1,745	1,622	1,419	1,199	1,030	771	621	462	284	197
1.67V	1,608	1,495	1,315	1,119	975	738	600	453	279	194
1.70V	1,539	1,427	1,260	1,084	947	724	590	447	276	193
1.75V	1,412	1,306	1,161	1,012	895	701	578	435	270	190
1.80V	1,273	1,181	1,060	944	853	676	561	418	263	186
1.85V	1,100	1,045	966	877	805	648	536	402	253	181

Trickle (or Float) Service Life

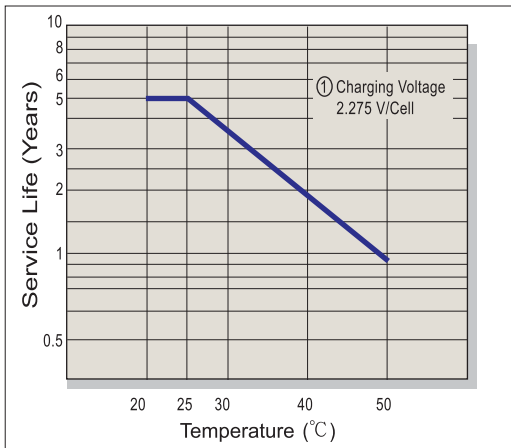

Capacity Retention Characteristic

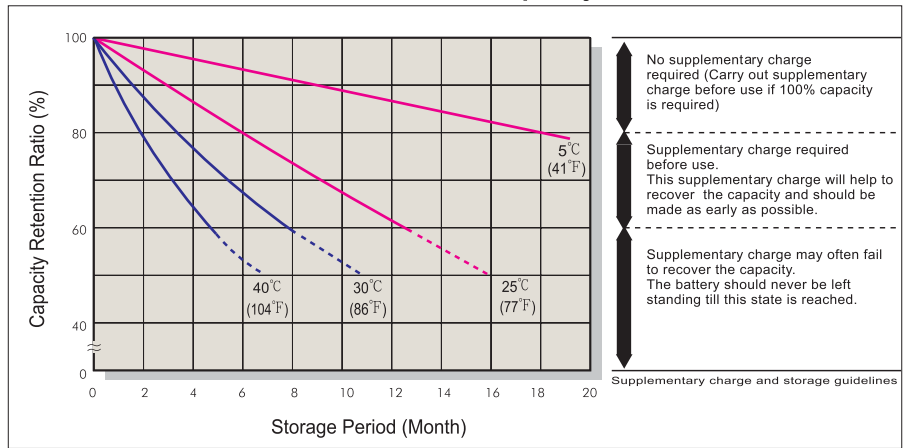

Battery Voltage and Charge Time for Standby Use

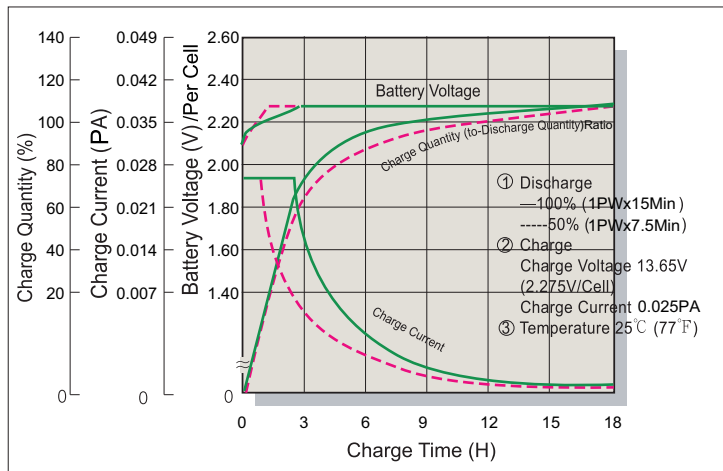

Cycle Service Life

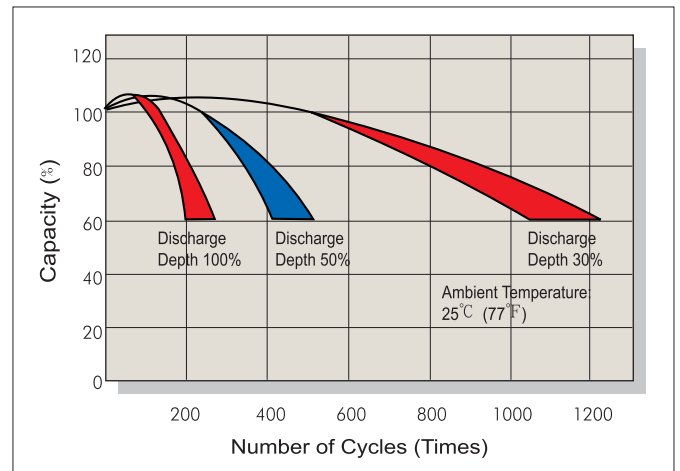

Battery Voltage and Charge Time for Cycle Use

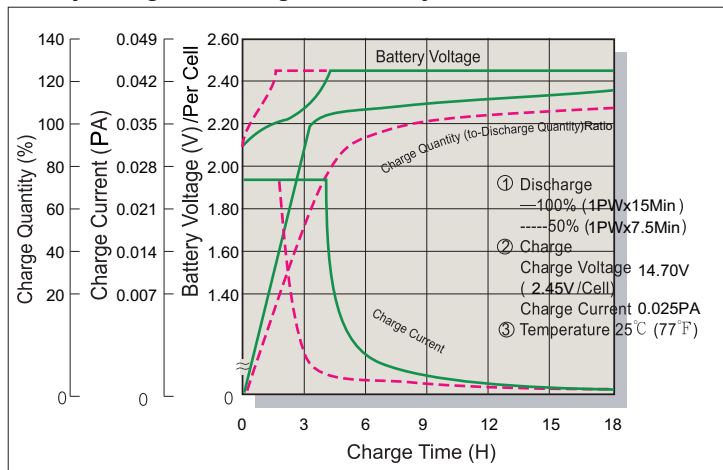

Terminal Voltage (V) and Discharge Time

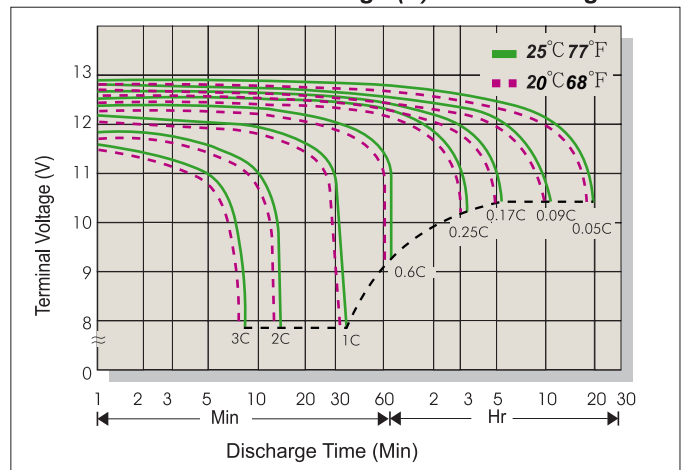

Charging Procedures

Application	Charge Voltage(V/Cell)			Max.Charge Current
	Temperature	Set Point	Allowable Range	
Cycle Use	25°C(77°F)	2.45	2.40~2.50	0.3C
Standby	25°C(77°F)	2.275	2.25~2.30	

Discharge Current VS. Discharge Voltage

Final Discharge Voltage V/Cell	1.75	1.70	1.60	1.30
Discharge Current(A)	0.2C>(A)	0.2C<(A)<0.5C	0.5C<(A)<1.0C	(A)>1.0C

Sales Office URL: WWW.CSB-BATTERY.COM

GLOBAL HQ
CSB BATTERY CO., LTD. (TAIWAN)
 Tel : +886-2-2555-5600
 Fax : +886-2-2555-3300
 mail : service@csb-battery.com.tw

BEIJING OFFICE. (CHINA)
CSB BATTERY TECHNOLOGIES (BEIJING) CO., LTD.
 Tel : +86-10-59621300/1301/1302/1303
 Fax : +86-10-59621304
 mail : chinasl@csb-battery.com

AMERICA HQ
CSB BATTERY TECHNOLOGIES INC. (U.S.A)
 Tel : +1-817-244-7777/1-(800)3-CSB-USA(272872)
 Fax : +1-817-244-4445
 mail : csb@csb-battery.com

SHANGHAI OFFICE. (CHINA)
CSB BATTERY LOGISTIC (SHANGHAI) CO., LTD.
 Tel : +86-21-5046-1622/5046-0833
 Fax : +86-21-5064-3314
 mail : chinasl@csb-battery.com

EUROPE HQ
CSB Battery Europe BV.
 Tel : +31(0)-180-418-140
 Fax : +886-2-2555-3300
 mail : eurosales@csb-battery.eu

SHENZHEN OFFICE. (CHINA)
CSB BATTERY LOGISTIC (SHANGHAI) CO., LTD.
 Tel : +86-755-8831-6488/6396/6356
 Fax : +86-755-8831-6548
 mail : she@csb-battery.com.cn

Данный компонент на территории Российской Федерации

Вы можете приобрести в компании MosChip.

Для оперативного оформления запроса Вам необходимо перейти по данной ссылке:

<http://moschip.ru/get-element>

Вы можете разместить у нас заказ для любого Вашего проекта, будь то серийное производство или разработка единичного прибора.

В нашем ассортименте представлены ведущие мировые производители активных и пассивных электронных компонентов.

Нашей специализацией является поставка электронной компонентной базы двойного назначения, продукции таких производителей как XILINX, Intel (ex.ALTERA), Vicor, Microchip, Texas Instruments, Analog Devices, Mini-Circuits, Amphenol, Glenair.

Сотрудничество с глобальными дистрибьюторами электронных компонентов, предоставляет возможность заказывать и получать с международных складов практически любой перечень компонентов в оптимальные для Вас сроки.

На всех этапах разработки и производства наши партнеры могут получить квалифицированную поддержку опытных инженеров.

Система менеджмента качества компании отвечает требованиям в соответствии с ГОСТ Р ИСО 9001, ГОСТ РВ 0015-002 и ЭС РД 009

Офис по работе с юридическими лицами:

105318, г.Москва, ул.Щербаковская д.3, офис 1107, 1118, ДЦ «Щербаковский»

Телефон: +7 495 668-12-70 (многоканальный)

Факс: +7 495 668-12-70 (доб.304)

E-mail: info@moschip.ru

Skype отдела продаж:

moschip.ru

moschip.ru_4

moschip.ru_6

moschip.ru_9