

# SERIES 100A SWITCHES

## TOGGLE SWITCHES - MINIATURE



### FEATURES & BENEFITS

- ▶ Variety of switching functions
- ▶ Miniature
- ▶ Multiple actuator & bushing options
- ▶ Sealed to IP67

### APPLICATIONS/MARKETS

- ▶ Telecommunications
- ▶ Instrumentation
- ▶ Networking
- ▶ Medical equipment

### SPECIFICATIONS

Contact Rating:	Dependent upon contact material
Life Expectancy:	30,000 make-and-break cycles at full load
Contact Resistance:	10 mΩ max. typical initial @ 2-4 VDC 100 mA for both silver and gold plated contacts
Insulation Resistance:	1,000 MΩ min.
Dielectric Strength:	1,000 V RMS @ sea level
Operating Temperature:	-30° C to 85° C

### MATERIALS

Case & Bushing:	PBT
Pedestal of Case:	LPC
Actuator:	Brass, chrome plated with internal O-ring seal
Switch Support:	Brass or steel tin plated
Contacts / Terminals:	Silver or gold plated copper alloy

### HOW TO ORDER

SERIES	MODEL NO.	ACTUATOR	BUSHING	TERMINATION	CONTACT MATERIAL	SEAL	HARDWARE
100A	□ □ □ □	□ □	□ □	□ □ □ □	□	E	□
	WSP1 WSP2 WSP3 WSP4 WSP5 WDP1 WDP2 WDP3 WDP4 WDP5	T1 T2	B1 B4	M1 M2 M5 M6 M7 VS2 VS3	Q = Silver R = Gold	E = Epoxy Sealed at Base of Terminal	H = Hardware

### Example Ordering Number

100A-WDP4-T1-B4-M1-R-E

Specifications subject to change without notice.

## SPDT



Model No.	POS 1	POS 2	POS 3
WSP-1	ON	NONE	ON
WSP-2	ON	NONE	(ON)
WSP-3	ON	OFF	ON
WSP-4	(ON)	OFF	(ON)
WSP-5	ON	OFF	(ON)
Term. Comm.	2-3	OPEN	2-1

( ) = Momentary

## DPDT



SCHEMATIC



Model No.	POS 1	POS 2	POS 3
WDP-1	ON	NONE	ON
WDP-2	ON	NONE	(ON)
WDP-3	ON	OFF	ON
WDP-4	(ON)	OFF	(ON)
WDP-5	ON	OFF	(ON)
Term. Comm.	2-3, 5-6	OPEN	2-1, 5-4

( ) = Momentary

## ACTUATOR OPTIONS

**T1**



T1 actuator std. when ordered with M1 termination.  
Add 0.100 (2.54) for B4 bushing.

**T2**



T2 actuator std. when ordered with VS, M2, M6 or M7 terminations.  
Add 0.100 (2.54) for B4 bushing.

## BUSHING OPTIONS

**B1**



Std for M1

**B4**



Std for M2, M6, M7, VS termination

# SERIES 100A SWITCHES

## TOGGLE SWITCHES - MINIATURE

TACT SWITCHES

NAVIGATION SWITCHES

PUSHBUTTON SWITCHES

TOGGLE SWITCHES

ROCKER SWITCHES

SLIDE SWITCHES

SNAP-ACTION SWITCHES

DIP SWITCHES

KEYLOCK SWITCHES

ROTARY SWITCHES

DETECTOR SWITCHES

CAP OPTIONS

### TERMINATION OPTIONS

#### M1

SPDT



P.C. MOUNTING

#### M1

DPDT



P.C. MOUNTING

#### M2

SPDT



P.C. MOUNTING

#### M2

DPDT



P.C. MOUNTING



### M6

SPDT

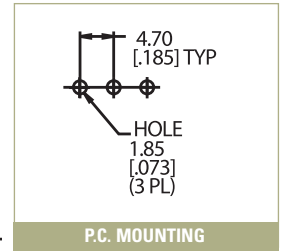

### M6

DPDT



### M7

SPDT

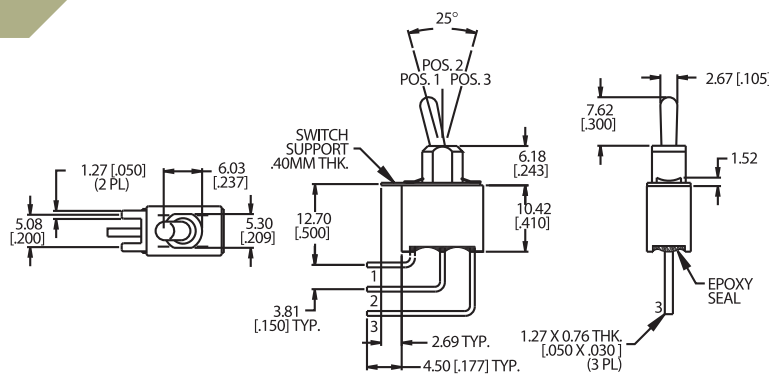

### M7

DPDT

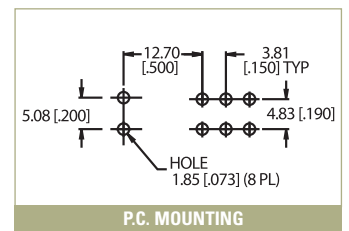

# SERIES 100A SWITCHES

## TOGGLE SWITCHES - MINIATURE

TACT SWITCHES

NAVIGATION SWITCHES

PUSHBUTTON SWITCHES

TOGGLE SWITCHES

### VS2-VS3

SPDT

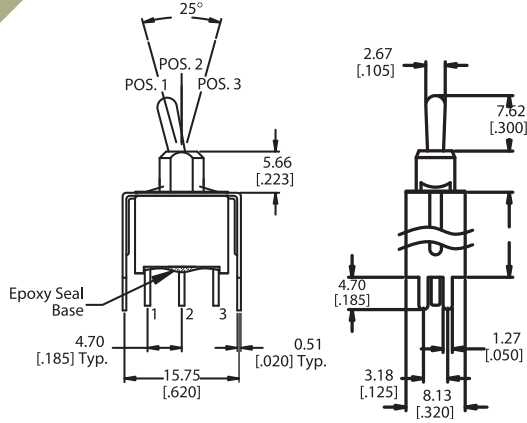

Option Code	Dim. 'A'
VS2	.460 (11.68)
VS3	.630 (16.00)

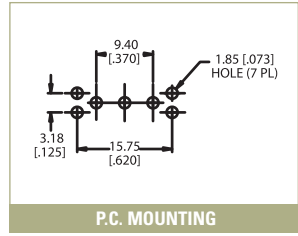

P.C. MOUNTING

ROCKER SWITCHES

SLIDE SWITCHES

SNAP-ACTION SWITCHES

DIP SWITCHES

KEYLOCK SWITCHES

ROTARY SWITCHES

DETECTOR SWITCHES

CAP OPTIONS

### VS2-VS3

DPDT

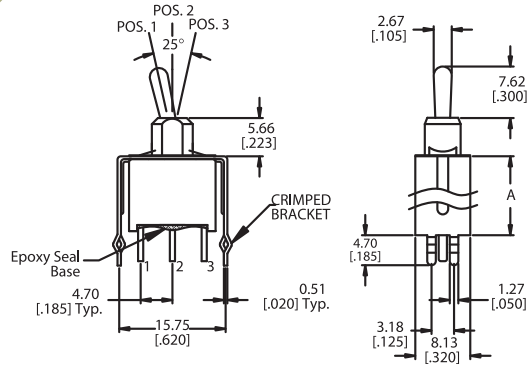

Option Code	Dim. 'A'
VS2	.460 (11.68)
VS3	.630 (16.00)

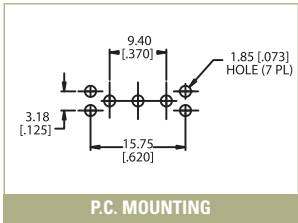

P.C. MOUNTING

### CONTACT MATERIAL OPTIONS

**Q**

Fixed Terminal:	Gold flash over silver plated copper alloy
Moving Contact:	Silver plated copper alloy
Rating:	5 Amps with resistive load @ 120VAC or 28VDC; 2 Amps with resistive load @ 250VAC

**R**

Fixed Terminal:	Copper alloy with gold plate over nickel plate
Moving Contact:	Copper alloy with gold plate overnickel plate
Rating:	0.4 Volt-Amps (VA) max. @ 20V max. (AC or DC)

### HARDWARE

#### HDW2 NUT

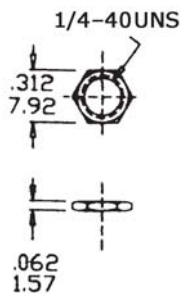

#### HDW15 LOCKING RING

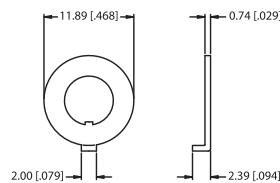

#### HDW11 LOCK WASHER

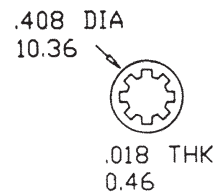

## Данный компонент на территории Российской Федерации

### Вы можете приобрести в компании MosChip.

Для оперативного оформления запроса Вам необходимо перейти по данной ссылке:

<http://moschip.ru/get-element>

Вы можете разместить у нас заказ для любого Вашего проекта, будь то серийное производство или разработка единичного прибора.

В нашем ассортименте представлены ведущие мировые производители активных и пассивных электронных компонентов.

Нашей специализацией является поставка электронной компонентной базы двойного назначения, продукции таких производителей как XILINX, Intel (ex.ALTERA), Vicor, Microchip, Texas Instruments, Analog Devices, Mini-Circuits, Amphenol, Glenair.

Сотрудничество с глобальными дистрибьюторами электронных компонентов, предоставляет возможность заказывать и получать с международных складов практически любой перечень компонентов в оптимальные для Вас сроки.

На всех этапах разработки и производства наши партнеры могут получить квалифицированную поддержку опытных инженеров.

Система менеджмента качества компании отвечает требованиям в соответствии с ГОСТ Р ИСО 9001, ГОСТ РВ 0015-002 и ЭС РД 009

### Офис по работе с юридическими лицами:

105318, г.Москва, ул.Щербаковская д.3, офис 1107, 1118, ДЦ «Щербаковский»

Телефон: +7 495 668-12-70 (многоканальный)

Факс: +7 495 668-12-70 (доб.304)

E-mail: [info@moschip.ru](mailto:info@moschip.ru)

Skype отдела продаж:

moschip.ru

moschip.ru\_4

moschip.ru\_6

moschip.ru\_9