

# SERIES 100A SWITCHES

## TOGGLE SWITCHES - MINIATURE



### FEATURES & BENEFITS

- ▶ Variety of switching functions
- ▶ Miniature
- ▶ Multiple actuator & bushing options
- ▶ Sealed to IP67

### APPLICATIONS/MARKETS

- ▶ Telecommunications
- ▶ Instrumentation
- ▶ Networking
- ▶ Medical equipment

### SPECIFICATIONS

Contact Rating:	Dependent upon contact material
Life Expectancy:	30,000 make-and-break cycles at full load
Contact Resistance:	10 mΩ max. typical initial @ 2-4 VDC 100 mA for both silver and gold plated contacts
Insulation Resistance:	1,000 MΩ min.
Dielectric Strength:	1,000 V RMS @ sea level
Operating Temperature:	-30° C to 85° C

### MATERIALS

Case & Bushing:	PBT
Pedestal of Case:	LPC
Actuator:	Brass, chrome plated with internal O-ring seal
Switch Support:	Brass or steel tin plated
Contacts / Terminals:	Silver or gold plated copper alloy

### HOW TO ORDER

SERIES	MODEL NO.	ACTUATOR	BUSHING	TERMINATION	CONTACT MATERIAL	SEAL	HARDWARE
100A	□ □ □ □	□ □	□ □	□ □ □ □	□	E	□
	WSP1 WSP2 WSP3 WSP4 WSP5 WDP1 WDP2 WDP3 WDP4 WDP5	T1 T2	B1 B4	M1 M2 M5 M6 M7 VS2 VS3	Q = Silver R = Gold	E = Epoxy Sealed at Base of Terminal	H = Hardware

### Example Ordering Number

100A-WDP4-T1-B4-M1-R-E

Specifications subject to change without notice.

## SPDT



Model No.	POS 1	POS 2	POS 3
WSP-1	ON	NONE	ON
WSP-2	ON	NONE	(ON)
WSP-3	ON	OFF	ON
WSP-4	(ON)	OFF	(ON)
WSP-5	ON	OFF	(ON)
Term. Comm.	2-3	OPEN	2-1

( ) = Momentary

## DPDT



SCHEMATIC



Model No.	POS 1	POS 2	POS 3
WDP-1	ON	NONE	ON
WDP-2	ON	NONE	(ON)
WDP-3	ON	OFF	ON
WDP-4	(ON)	OFF	(ON)
WDP-5	ON	OFF	(ON)
Term. Comm.	2-3, 5-6	OPEN	2-1, 5-4

( ) = Momentary

## ACTUATOR OPTIONS

T1



T1 actuator std. when ordered with M1 termination.  
Add 0.100 (2.54) for B4 bushing.

T2



T2 actuator std. when ordered with VS, M2, M6 or M7 terminations.  
Add 0.100 (2.54) for B4 bushing.

## BUSHING OPTIONS

B1



Std for M1

B4



Std for M2, M6, M7, VS termination

# SERIES 100A SWITCHES

## TOGGLE SWITCHES - MINIATURE

TACT  
SWITCHES

NAVIGATION  
SWITCHES

PUSHBUTTON  
SWITCHES

TOGGLE  
SWITCHES

ROCKER  
SWITCHES

SLIDE  
SWITCHES

SNAP-ACTION  
SWITCHES

DIP  
SWITCHES

KEYLOCK  
SWITCHES

ROTARY  
SWITCHES

DETECTOR  
SWITCHES

CAP  
OPTIONS

### TERMINATION OPTIONS

#### M1

SPDT



P.C. MOUNTING

#### M1

DPDT

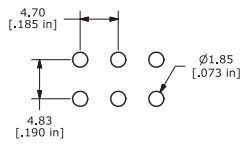

P.C. MOUNTING

#### M2

SPDT



P.C. MOUNTING

#### M2

DPDT

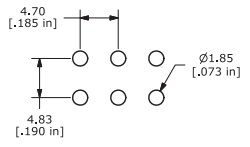

P.C. MOUNTING



### M6

SPDT



### M6

DPDT

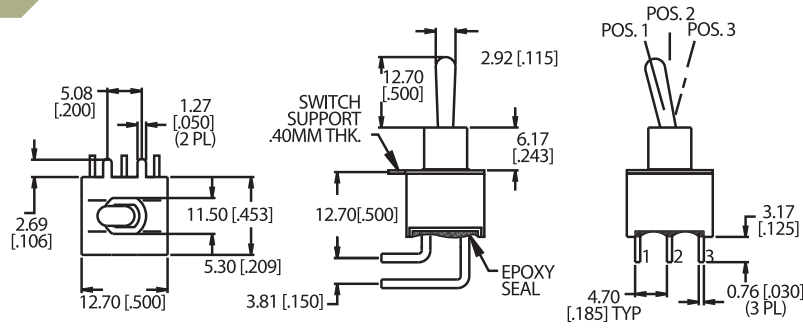
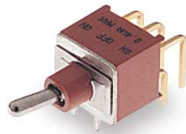

### M7

SPDT

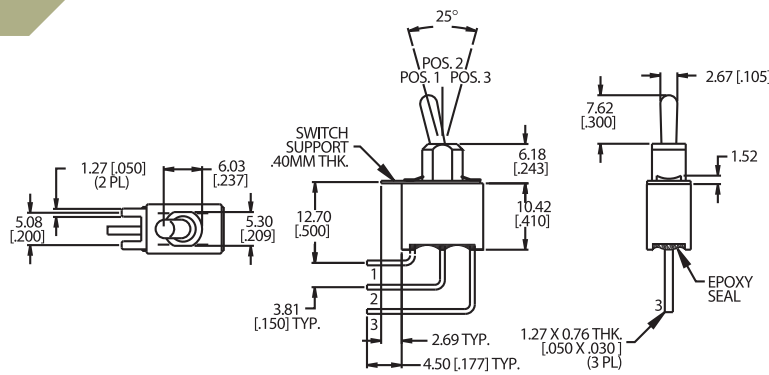
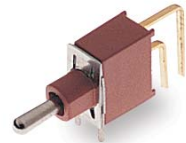

### M7

DPDT

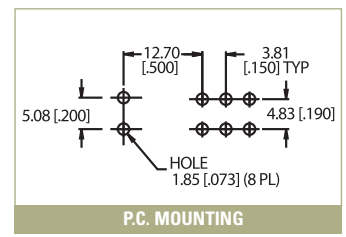
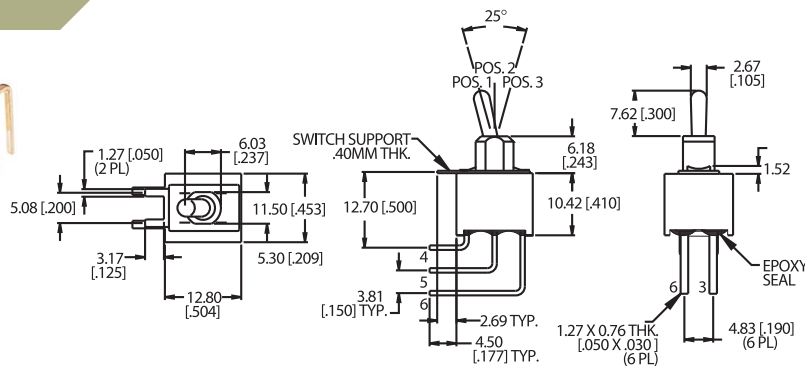

TACT SWITCHES

NAVIGATION SWITCHES

PUSHBUTTON SWITCHES

TOGGLE SWITCHES

ROCKER SWITCHES

SLIDE SWITCHES

SNAP-ACTION SWITCHES

DIP SWITCHES

KEYLOCK SWITCHES

ROTARY SWITCHES

DETECTOR SWITCHES

CAP OPTIONS

# SERIES 100A SWITCHES

## TOGGLE SWITCHES - MINIATURE

### VS2-VS3

SPDT



Option Code	Dim. 'A'
VS2	.460 (11.68)
VS3	.630 (16.00)



P.C. MOUNTING

### VS2-VS3

DPDT

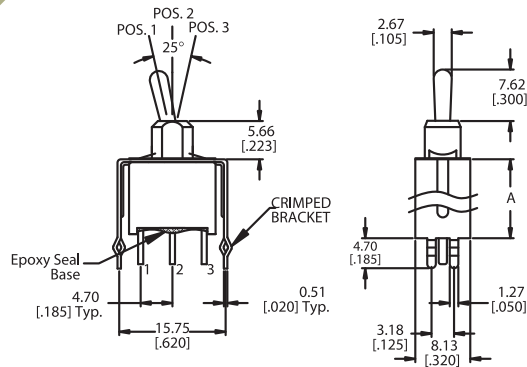

Option Code	Dim. 'A'
VS2	.460 (11.68)
VS3	.630 (16.00)



P.C. MOUNTING

### CONTACT MATERIAL OPTIONS

**Q**

Fixed Terminal:	Gold flash over silver plated copper alloy
Moving Contact:	Silver plated copper alloy
Rating:	5 Amps with resistive load @ 120VAC or 28VDC; 2 Amps with resistive load @ 250VAC

**R**

Fixed Terminal:	Copper alloy with gold plate over nickel plate
Moving Contact:	Copper alloy with gold plate overnickel plate
Rating:	0.4 Volt-Amps (VA) max. @ 20V max. (AC or DC)

### HARDWARE

**HDW2 NUT**



**HDW15 LOCKING RING**



**HDW11 LOCK WASHER**

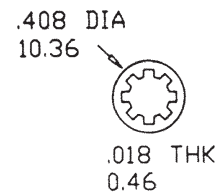

## Данный компонент на территории Российской Федерации

### Вы можете приобрести в компании MosChip.

Для оперативного оформления запроса Вам необходимо перейти по данной ссылке:

<http://moschip.ru/get-element>

Вы можете разместить у нас заказ для любого Вашего проекта, будь то серийное производство или разработка единичного прибора.

В нашем ассортименте представлены ведущие мировые производители активных и пассивных электронных компонентов.

Нашей специализацией является поставка электронной компонентной базы двойного назначения, продукции таких производителей как XILINX, Intel (ex.ALTERA), Vicor, Microchip, Texas Instruments, Analog Devices, Mini-Circuits, Amphenol, Glenair.

Сотрудничество с глобальными дистрибьюторами электронных компонентов, предоставляет возможность заказывать и получать с международных складов практически любой перечень компонентов в оптимальные для Вас сроки.

На всех этапах разработки и производства наши партнеры могут получить квалифицированную поддержку опытных инженеров.

Система менеджмента качества компании отвечает требованиям в соответствии с ГОСТ Р ИСО 9001, ГОСТ РВ 0015-002 и ЭС РД 009

### Офис по работе с юридическими лицами:

105318, г.Москва, ул.Щербаковская д.3, офис 1107, 1118, ДЦ «Щербаковский»

Телефон: +7 495 668-12-70 (многоканальный)

Факс: +7 495 668-12-70 (доб.304)

E-mail: [info@moschip.ru](mailto:info@moschip.ru)

Skype отдела продаж:

moschip.ru

moschip.ru\_4

moschip.ru\_6

moschip.ru\_9